



Radio | CD | SD | USB | MP3 | WMA

Casablanca MP56

7 646 580 310

Bedienungsanleitung
Operating instructions
Notice d'emploi
Istruzioni d'uso
Gebruiksaanwijzing



<http://www.blaupunkt.com>



BLAUPUNKT



Index

About these instructions	72
For your safety	72
Scope of delivery	73
Warranty	73
Device overview	74
Controls	74
Placing the device in operation	75
Detaching/attaching the control panel	75
Switching the device on/off.....	76
General functions	76
Inserting a CD.....	76
Inserting an MMC/SD card	77
Connecting the USB medium.....	77
Adjusting the volume	78
Muting the device	78
Operation with telephone.....	78
Selecting an audio source	79
The tuner display.....	80
The audio CD display	80
The CD changer display	81
The MP3 display *)	81
Overview of the operation	82
Overview of the buttons	82
Overview of the functions MIX, RPT, and TRAFFIC	83
Switching random track play on/off (MIX)	83
Switching Repeat title on/off (REPEAT)	84
Scanning titles (SCAN).....	84
Buttons for menu operation	84
Example of a menu operation	85
Calling up a menu	85
Selecting a menu item in the settings menu.....	85
Changing and saving a setting.....	86
Exiting a menu item.....	86
Operating the tuner	87
Searching for stations.....	87
Manually searching for stations... ..	87
Automatically searching for stations	88
Storing stations	89
Listening to stored stations	89
Scanning all receivable stations (SCAN)	89
Set the device to the region Europe, USA or Thailand	90
Changing the tuner settings ("TUNER" MENU)	91
Permanently switching the priority of traffic announcements on/off (TRAFFIC)	91
Switching the display of radio text on/off (R-TEXT)	92
Allowing alternative frequencies (RDS)	92
Searching FM stations automatically and storing them in the FMT memory bank (T-STORE) ..	92
Changing the seek tuning sensitivity (SENS)	92
Allowing/preventing automatic changing to other regional programmes (REGIONAL)	93
Activating/deactivating improved reception (HIGH CUT)	93

- Restricting station seek tuning to certain programme contents (PROG TYP)94
Toggle between mono and stereo operation (MONO)94
- Traffic announcements (TA)95**
Receiving traffic announcements95
Skipping a traffic announcement.....95
Permanently switching the priority of traffic announcements on/off.....95
- Operating the integrated CD player.....97**
What features do MP3 or WMA CDs have to have?.....97
Functions of the integrated CD player if an audio CD is inserted ..98
Switching the CD text display on/off (TEXT)99
Switching the scrolling text for CD text on/off (SCROLL).....99
- Operating the MP3/WMA player..100**
- Showing all the information of the current title (SHOW ALL).....101**
Switching scrolling text on/off (SCROLL).....101
Selecting the title information to be displayed (INFO).....101
Selecting a title from a list (Browser mode/playlist)102
- Operating the optional CD changer.....104**
Selecting a CD from the CD magazine (CD overview)105
Changing the name of a CD in the magazine of the CD changer (CD NAME).....105
- Changing basic settings in the settings menu106**
Adjusting sound and balance (AUDIO)107
Changing treble or bass (TREBLE/BASS)107
Changing the volume distribution (BALANCE/FADER)107
Changing the equalizer setting (DEQ)108
Creating/changing a user-defined equalizer setting (ADJUST)109
Which equalizer setting is the correct one?.....111
Selecting a sound presetting (PRESET).....112
Setting the speed-dependent volume increase (AUTO SND).....112
Setting the bass increase (XBASS)112
Configuring the preamplifier output for the subwoofer (SUBOUT)112
Switching the equalizer off (OFF).....113
- Changing display settings (DISPLAY)114
Changing the colour of the display (COLOR)114
Changing the user-defined colour (USER)115
Adjusting the display viewing angle (ANGLE).....115
Inverting the display (INVERT) ...116
Switching the spectrum analyser on/off (SPECTRUM)116
Activating/deactivating the screen saver (SCREEN S).....116
- Changing volume presettings (VOLUME)117

Changing the volume presetting of traffic announcements (TRAFFIC).....	117	Resetting the device to factory settings (NORMSET)	124
Changing the volume presetting of the telephone (PHONE)	118	Changing the scan time (SCANTIME)	124
Changing the volume presetting of the signal tone (BEEP)	118	Displaying the serial number (SER NUM)	125
Changing the presetting of the power-on volume (ON VOL)	118	Error table	125
Restoring the volume at switch-on (LAST VOL)	118	Technical data	126
Changing clock settings (CLOCK).....	119	Glossary	127
Setting the time (TIME).....	120	Index	130
Switching the time display on/off with switched-off device (OFFCLOCK)	120	Installation instructions	332
Switching the RDS synchronisation of the clock on/off (AUTOSYNC).....	120		
Switching the 24-hour time display on/off (24H MODE).....	120		
Configuring audio inputs (AUX)	121		
Activating/deactivating audio inputs (AUX1/2)	121		
Renaming audio inputs (EDIT)	121		
Changing special settings (VARIOUS)	123		
Changing the welcome text (ON MSG)	123		
Switching the internal amplifier on/off (AMP ON)	124		

Blaupunkt stands for technical know-how in mobile radio reception, for precise navigation systems and first-class sound. The blue dot made its debut in 1923 as a seal of quality that was assigned after rigorous functional – and it still applies today. At that time as well as today, the blue dot identifies products of extraordinary quality.

About these instructions

Please read these instructions and, in particular, the following chapter, "For your safety", before using the device! Please also observe the following instructions:

- CD Changer, if available
- Remote Control, if available

For your safety

The device was manufactured according to the state of the art and established safety guidelines. Even so, dangers may occur if you do not observe these safety information:

- Read these instructions carefully and completely before using the device.
- Keep the instructions at a location so that they are always accessible to all users.
- Always pass on the device to third parties together with these instructions.

Use as directed

The device is designed for operation in a vehicle with 12 V vehicle system voltage and must be installed in a DIN slot.

If you are installing device yourself

You may only install the device yourself if you are experienced in installing car sound systems and are very familiar with the electrical system of the vehicle.

Observe the following!



Danger of injuries!

Do not open or modify the device! The device contains a Class 1 laser that emits invisible laser radiation which can cause injuries to your eyes. The warranty is void if the device has been opened.



Danger of accidents!

Operate the device only if traffic situation permits it!



Danger of hearing damage!

Always listen at moderate volume so that you can always hear acoustic warning signals! This will also help to protect your hearing. The device briefly switches to mute, e.g. while the CD changer changes the CD or if you are switching the audio source. Do not increase the volume during this mute phase



Danger to the device!

Do not insert any mini CDs (8 cm diameter) and shape CDs since they destroy the drive!

Theft protection

Carry the control panel with you in the supplied case whenever you leave the vehicle.

Cleaning

Clean the device with a dry or slightly moistened cloth. Do not use any solvents, cleaning agents or cleansers and no cockpit spray and care product for plastic materials.



Disposal

Do not dispose of your old device in the household trash. Please use the available return and collection systems for the disposal.

Scope of delivery

- 1 Casablanca MP56
- 1 Case for the control panel
- 1 Operating instructions
- 1 Support frame
- 2 Disassembly bar

- 1 Guide pin
- 1 USB connecting cable

Note:

Remote controls are available as optional equipment. You can find out from your Blaupunkt dealer or on the Internet at www.blaupunkt.com which remote controls can be used with this device.

Warranty

We provide a manufacturer's warranty for products bought within the European Union. For devices purchased outside the European Union, the warranty terms issued by our respective responsible domestic agency are valid.

The warranty terms can be called up under www.blaupunkt.com or requested directly from:

Blaupunkt GmbH
Hotline
Robert-Bosch-Str. 200
D-31139 Hildesheim

Device overview

Controls

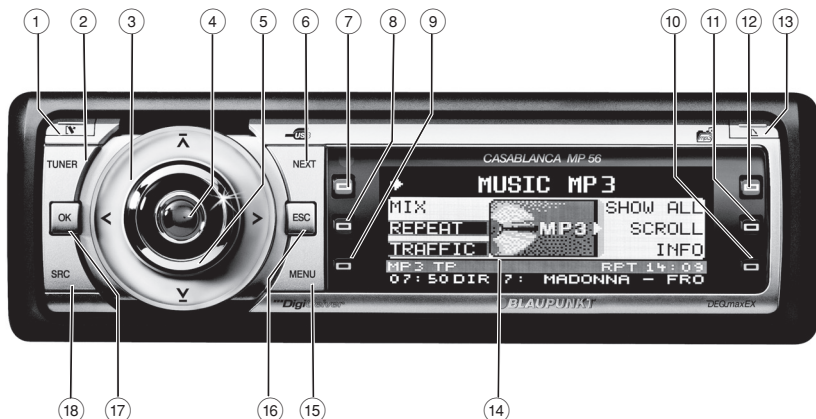

- ① **V** button
for detaching the control panel
- ② **TUNER** button
Selecting the tuner as audio source
Opening the "TUNER" menu
- ③ Rocker switch
Tuner: Start the station seek tuning
Settings menu: Change settings
- ④ On/Off button
Press short: Switch on/mute
Press long: Switch off
- ⑤ Volume control
- ⑥ **NEXT** button
Tuner: Select memory bank (FM1, FM2, FM3, FMT)
Settings menu: Go to the next menu page
MP3/WMA: Switch between "PLAY", "BROWSER" and "PLAYLIST"
- ⑦ to ⑫ Softkeys
to select the function shown on the display next to the respective button
- ⑬ **EJECT** button
to eject/insert a CD
- ⑭ Display (see page 80 and 81)

- ⑮ **MENU** button
to call up the settings menu
- ⑯ **ESC** button
Settings menu: Confirm menu item and change to the display of the audio source
Scan/Travelstore: Cancel
- ⑰ **OK** button
Press short: Confirm menu item and change to the next higher menu level
Press long: Start scan/station seek tuning
- ⑱ **SRC** button
Consecutively switching between the available audio sources
- ⑲ CD drive

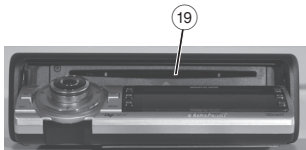

- ⑳ MMC/SD card slot

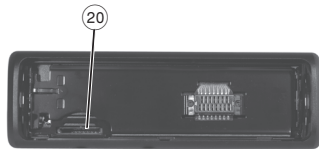

Placing the device in operation

Detaching/attaching the control panel

You can detach the control panel to protect against theft.



CAUTION!

Danger of theft!

The device is worthless to a thief without the control panel.

- Never keep the control panel in the vehicle, not even in a hidden place; instead, carry it with you in its case when you leave the vehicle!



CAUTION!

Damage to the control panel!

The control panel can be damaged or malfunction if the following is not observed:

- Never drop the control panel.
- Do not expose the control panel to direct sunlight or another heat source.
- Transport it exclusively in the supplied case.

General functions

- Do not touch the contacts on the rear side with your fingers.
- Clean the contacts of the control panel regularly using a soft cloth moistened with cleaning alcohol.

To detach the control panel:

- Press the  button ①.

The control panel opens to the front on the left. The device switches off automatically.

- Detach the control panel.

To attach the control panel:

- Place the control panel in the slot with the right side first.
- Next, carefully push the left side to the back until the control panel engages.

Switching the device on/off

To switch on the device:

- Press the On/Off button ④.

The device plays the audio source you previously listened to.

Note:

If you switch on the device without first switching on the vehicle ignition, the device automatically switches off after one hour to save the vehicle battery.

To switch off the device:

- Press and hold the On/Off button ④ for approx. two seconds.

In addition, the device is automatically switched off as soon as you switch of the vehicle ignition. If you switch on the ignition again, it also automatically switches on the device again.

General functions

Inserting a CD



CAUTION!

Damage to CD drive from unsuitable CDs!

Mini CDs (8 cm diameter) or shape CDs damage the drive!

- Insert only circular CDs with a 12-cm diameter into the CD drive.

To insert an MP3, WMA or audio CD, the device must be switched on.

- Press the  button ⑬.

The control panel opens. If a CD is in the drive, it is ejected. If you do not remove this CD, it is automatically pulled in again after approx. 10 seconds.

- Insert the CD with its printed side uppermost into the CD drive (19) until you feel some resistance.

The CD is automatically drawn in and the control panel closes. This CD can now be selected as audio source.

Note:

As long as the CD is in the drive, the device stores track and playing time of the CD played last, and after calling up the audio source, the playback starts at the position where it was interrupted.

Inserting an MMC/SD card

Note:

Blaupunkt cannot guarantee the correct functioning of all MMC/SD card available on the market and, for this reason, recommends the use of MMC/SD cards manufactured by "SanDisk" or "Panasonic". The cards must be formatted using the FAT16 or FAT32 file system and contain MP3 or WMA files.

- Remove the control panel as described on page 9.
- Insert the MMC/SD card in the card slot (20) until it engages. The contacts of the card must point down and to the rear.

- Attach the control panel as described on page 9.

This MMC/SD card can now be selected as audio source.

To remove the MMC/SD card:

- Remove the control panel as described on page 9.
- Push on the MMC/SD card until it disengages.
- Pull the MMC/SD card out of the card slot (20).

Connecting the USB medium

To be able to connect a USB stick or a USB hard disk, the supplied USB cable must be connected to the rear side of the device before the installation as described in the installation instructions. This cable can be routed, for example, to the glove compartment or a suitable place of the center console.

Note:

Always switch off the device before connecting or disconnecting your USB medium!

- Connect the USB medium to the USB cable that is routed from the rear side of the device.
- The USB medium can now be selected as audio source.

For the device to recognise the USB medium, it must be specified as mass storage device and formatted using the FAT16 or FAT32 file system and contain MP3 or WMA files. Blaupunkt cannot guarantee the proper functioning of all USB media available on the market. If extensive files are stored on your USB medium, the file search (see page 102) can be slow.

Adjusting the volume



WARNING!

Danger from excessive volume!

Excessive volume can damage your hearing and you may fail to hear acoustic warning signals!

- Do not increase the volume while the device changes the CD in the CD changer or the audio source.
- Always set the device to a moderate volume.

-
- Turn the volume control (5).

The current volume is shown in the central area (B) of the display and used for all audio sources.

Note:

To preset the volume of traffic announcements (TRAFFIC), a connected telephone (PHONE) and the signal tone (BEEP), see pages 117 and 118.

Muting the device

The device can be muted as follows:

- Briefly press the On/Off button (4).

The display shows "MUTE".

To cancel the mute function:

- Briefly press the On/Off button (4) again or turn the volume control (5).

Operation with telephone

If a hands-free system is installed in your vehicle or your cell phone is connected to the device via a Bluetooth adapter, the device responds as follows to incoming or outgoing telephone calls:

- The voice of the person calling you is played back via the loudspeakers of the vehicle.
- The display shows "PHONE CALL".
- The currently playing audio source is muted.

- During the telephone call, you change the volume of the telephone call by means of the volume control ⑤.
- Traffic announcements (TA) are not automatically shown.

Selecting an audio source

The device features the following audio sources:

- Tuner
- Integrated CD player (can play audio CDs as well as CDs with MP3 or WMA files)
- MMC/SD card with MP3 or WMA files

In addition, the following external audio sources can be connected:

- Either an optional CD changer or AUX1
- AUX2 (e.g. MiniDisc or external MP3 player)
- USB stick with MP3 or WMA files

To be able to select an external audio source, it must be connected and contain audio data.

- Press the **SRC** button ⑱ repeatedly until the display briefly shows the desired audio source.

The tuner display

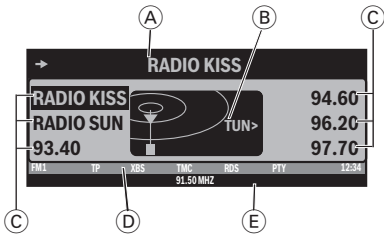

- Ⓐ Main line
Left: Arrow
Middle: Station name or frequency
- Ⓑ Central area
Audio source
- Ⓒ Memory location for radio stations which can be selected using the six softkeys (7) to (12)
- Ⓓ Info line 1
Left: memory bank
In between: TP ¹⁾, XBS ²⁾, TMC ³⁾, RDS ⁴⁾, PTY ⁵⁾
Right: Clock
- Ⓔ Info line 2
Frequency

The audio CD display

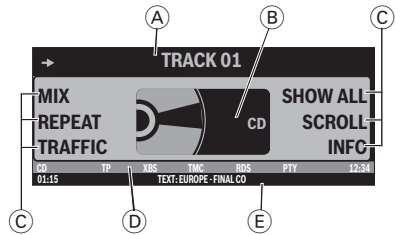

- Ⓐ Main line
Left: Arrow
Middle: Track number
- Ⓑ Central area
Audio source
- Ⓒ Functions which can be selected using the softkeys (7) to (12)
- Ⓓ Info line 1
Left: Audio source
In between: TP ¹⁾, XBS ²⁾, TMC ³⁾, RDS ⁴⁾, PTY ⁵⁾, RPT ⁶⁾, MIX ⁷⁾
Right: Clock
- Ⓔ Info line 2
Left: Playing time,
Middle: CD text

¹⁾ TP: appears if a traffic information station is set (see page 95).

²⁾ XBS: appears if XBass is switched on (see page 112).

³⁾ TMC: appears only if you connect an external navigation system and it starts searching for TMC stations.

⁴⁾ RDS: appears if changing to alternative frequencies is permitted (see page 92).

⁵⁾ PTY: appears if the station seek tuning was restricted to a specific programme type (see page 94).

The CD changer display

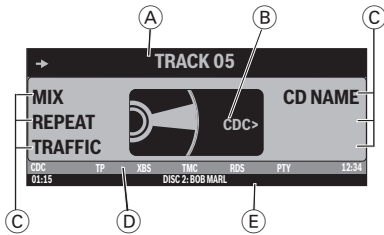

The MP3 display ^{a)}

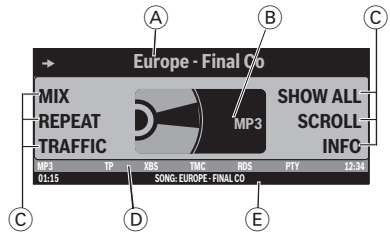

ENGLISH

- Ⓐ Main line
Left: Arrow
Middle: Track number
- Ⓑ Central area
Audio source
- Ⓒ Functions which can be selected using the softkeys ⑦ to ⑫
- Ⓓ Info line 1
Left: audio source
In between: TP ¹⁾, XBS ²⁾, TMC ³⁾, RDS ⁴⁾, PTY ⁵⁾, RPT ⁶⁾, MIX ⁷⁾
Right: Clock
- Ⓔ Info line 2
Left: Playing time,
Middle: CD text or CD name

- Ⓐ Main line
Left: Arrow
Middle: Track number
- Ⓑ Central area
Audio source
- Ⓒ Functions which can be selected using the softkeys ⑦ to ⑫
- Ⓓ Info line 1
Left: audio source
In between: TP ¹⁾, XBS ²⁾, TMC ³⁾, RDS ⁴⁾, PTY ⁵⁾, RPT ⁶⁾, MIX ⁷⁾
Right: Clock
- Ⓔ Info line 2
Left: Playing time,
Middle: Title information (e.g. ID3 or file name)

⁶⁾ RPT: appears if a repeat function is switched on (see page 84).

⁷⁾ MIX: appears if the random playback is switched on (see page 83).

^{a)} The MP3 display appears if a CD, SD/MMC card or USB stick with MP3 or WMA files is inserted and selected as audio source. The corresponding MP3 medium is displayed left on info line 1 (Ⓓ).

Overview of the operation

This chapter first presents the buttons on the device.

It is followed by a description of the audio functions MIX, REPEAT, TRAFFIC and SCAN since their operation is identical for all audio sources.

The operation of the device menus is described starting on page 84.



Overview of the buttons

Many basic functions during the playback of music, such as forwarding and reversing music, are performed using the rocker switch ③ (using the four functions >, <, $\bar{\wedge}$, and \vee), the **OK** button ⑰ or the six softkeys  ⑦ to ⑫.

Note:

These functions are **not** shown on the display!

The following table shows the functions that can be performed by these buttons.

What do you want to do?	Selectable audio sources					No operation possible of Casablanca	
	Tuner	CD	MP3/WMA	CDC	AUX		
Forward	–	Hold > pressed					
Reverse	–	Hold < pressed					
Title forward	–	> Press short					
Title reverse	–	< Press short					
Previous CD/folder	–	–	$\bar{\wedge}$ Press short				
Next CD/folder	–	–	\vee Press short				
Scan track/station (see also page 84)	Press OK for 2 seconds						
Play radio station	 Press short	–	–	–			
Store radio station	Press  for 2 s	–	–	–			

Overview of the functions MIX, RPT, and TRAFFIC

The display of the active audio source can show up to six functions (Ⓕ) at the left and right edge of the display which you always operate using the same six softkeys (Ⓗ) to (Ⓖ) independent of the audio source. The different settings of a function are selected by repeatedly pressing the same softkey.

The following table shows which settings are available for the functions MIX, REPEAT, and TRAFFIC.

Softkey next to the audio function	Selectable audio sources					
	Tuner	CD	MP3 CD	USB/SD/MMC	CDC	AUX
MIX (random track play) (see also page 83)	-	OFF CD	DIR CD OFF	ALL OFF FOLDER	OFF ALL CD	No operation possible of Casablanca
RPT (repeat mode) (see also page 84)	-	OFF TRACK	OFF DIR TRACK	OFF DIR TRACK	OFF CD TRACK	
TRAFFIC (traffic announcement, see page 96)	OFF ON					

Switching random track play on/off (MIX)

→ Press the softkey (Ⓗ) (next to "MIX").

The random track play mode is displayed on the main line (Ⓐ).

- "MIX CD": All tracks on the current audio CD are played in random order.
- "MIX ALL": All tracks on all CDs in the magazine of the CD changer are played in random order.

- "MIX FOLDER"/"MIX DIR": Up to 99 MP3 or WMA titles in the current folder are played in random order.
- "MIX MEDIUM": All MP3 or WMA titles on the current data carrier (CD, MMC/SD card or USB stick) are played in random order.
- "MIX OFF": The random track play is switched off. All titles are played in the order in which they are found on the data carrier.

If you switched on random track play, the selected random track play mode is displayed on info line 1 (D) and indicated by "MIX" at the side of the display.

Switching Repeat title on/off (REPEAT)

→ Press the softkey (8) (next to "REPEAT").

The repeat mode is displayed on the main line (A).

- "REPEAT TRACK": The current track is repeated until you quit repeat.
- "REPEAT DIR"/"REPEAT FOLDER": All titles in the current folder are repeated until you quit repeat.
- "REPEAT CD": All tracks on the CD are repeated until you quit repeat.
- "REPEAT OFF": The repeat mode is switched off. However, the playback does not stop with the last track. After the last title in the last folder, the playback is continued with the first title in the first folder.

The selected repeat mode is displayed on info line 1 (D) and indicated by "REPEAT" at the side of the display.

Scanning titles (SCAN)

You can scan all the titles of a data carrier. The scan time is selected in the settings menu ("SCANTIME" menu item, see pages 123 and 124).

→ Press and hold the **OK** button (17) for approx. two seconds.

All tracks are scanned. The main line of the display alternately shows "SCAN" and the track number or the file name.

To cancel the scan:

→ Press the **OK** button (17).

The playback of the current title is continued.

Buttons for menu operation

The device features menus which allow you to change the presettings or make a selection. The display shows up to six menu items. Each menu item is assigned to one of the six softkeys (7) to (12).

The following buttons are required to operate the menus:

- The **MENU** button (15) is used to call up the settings menu ("USER MENU") at any time.
- If a menu consists of several pages, you can consecutively scroll them using the **NEXT** button (6).

- If "TUNER" is selected as the audio source, the **TUNER** button ② calls up the "TUNER" menu.
- If the current menu features several pages, the left side of the main line (A) shows an arrow (➔). This means, you can use the **NEXT** button ⑥ to consecutively scroll the different pages.
- The softkeys ⑦ to ⑫ are used to select the menu items that are shown on the display next to the corresponding button.
- In some menus, the rocker switch ③ is used to change the setting of a menu item.

This setting is immediately effective and automatically stored.

- You confirm the setting with the **OK** button ⑰ and go back one higher menu level.
- If you are navigating in a menu, the right side of the main line (A) shows the ESC symbol (⏏). This means that you can exit the menu using the **ESC** button ⑱. You also confirm the displayed setting with the **ESC** button ⑱, but you are leaving the menu and return to the display of the active audio source.

- If you do not press any button, the display of the active audio source automatically appears after approx. 16 seconds.

Example of a menu operation

The following example from the settings menu (Changing the display brightness) shows how to operate the menus in general.

Calling up a menu

- ➔ Press the **MENU** button ⑮.

The settings menu ("USER MENU") is displayed.



Selecting a menu item in the settings menu

- ➔ Press the softkey ⑧ (next to "DISPLAY").

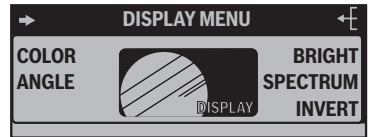

The "DISPLAY" menu appears.

- ➔ Press the softkey ⑫ (next to "BRIGHT").

The "BRIGHT" menu item is flashing. This means that you can now change the corresponding setting. In addition, the main line (A) displays the current settings for the display brightness at night ("NIGHT") and during the day ("DAY"). The "Night" menu item is flashing.



Since you can adjust the display brightness separately for night and day, you must switch between the menu items "NIGHT" and "DAY".

→ For this purpose, press the rocker switch (3) for > or < until the desired menu item is highlighted.

Changing and saving a setting

To change the display brightness:

→ On the rocker switch (3), press on $\bar{\wedge}$ or \vee .

The setting takes effect immediately (the display becomes brighter or darker). The setting is saved. If you do not press another button, the display of the active audio source automatically appears after approx. 16 seconds.

Exiting a menu item

- Press the **OK** button (17) to go up one menu level.
- Or press the **ESC** button (16) to exit the menu and return to the display of the active audio source.

Operating the tuner

After selecting "TUNER" as the audio source, the tuner display appears (see page 80). The playback starts immediately with the previously played station if the vehicle is within the reception area of this station.

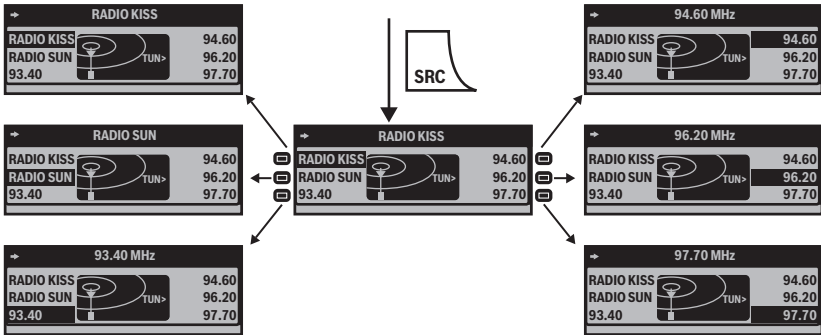

Selecting the memory bank

The device features four memory banks (FM1, FM2, FM3, and FMT). You can store or call up six stations at every memory bank.

→ Press the **NEXT** button (6) repeatedly until the desired memory bank appears on the level display (E) of the tuner display.

Searching for stations

You can search for stations manually or automatically.

Note:

To automatically search for FM stations and store them in the FMT memory bank, see "T-STORE" on page 92.

Manually searching for stations

→ While the tuner display appears, press on > or < on the rocker switch (3).

The response of the tuner depends upon the settings in the menus "RDS" (page 92) and "PROG TYP" (page 94).

- If you selected a specific program type (PTY, e.g. news, sports, classic, etc.) in the

"PROG TYP" menu, the tuner automatically searches the next station broadcasting this program type in the selected direction. For this purpose, the station must be broadcasting the corresponding PTY identification as RDS service.

- If you activated the automatic change to alternative frequencies in the "RDS" menu, the tuner searches for the same station on a different frequency.
- If you selected the "PTY OFF" option in the "PROG TYP" menu and deactivated the automatic change to alternative frequencies in the "RDS" menu, you can manually adjust the tuner in increments of 100 kHz.

As soon as a station has been located, it is played. The station name appears on the main line (A) after a few seconds if the station provides this RDS information.

You can now store this station (see page 89) or restart the manual station seek tuning.

Automatically searching for stations

→ While the tuner display appears, press on $\bar{\Delta}$ or ∇ on the rocker switch (3).

The tuner searches for the next station in the current waveband in the selected direction. The settings in the menus "SENS" (see page 92) and "PROG TYP" (see page 94) are incorporated.

As soon as a station is located, the seek tuning stops and the located station is played. The station name appears on the main line (A) after a few seconds if the station provides this RDS information.

You can now store this station (see p. 89) or restart the automatic station seek tuning.

Note:

If you press and hold $\bar{\Delta}$ or ∇ on the rocker switch (3), the automatic seek tuning skips the stations found until you release the rocker switch again.

Storing stations

After locating a station, you can store it as follows:

- Select the desired memory bank (see page 87).
- Press the softkey for approx. two seconds to which you want to assign the station.

The station is stored. A signal tone confirms that the station has been stored. The frequency or the name of the station **Ⓒ** is displayed next to the softkey. The current station is highlighted.

Note:

To automatically search for FM stations and store them in the FMT memory bank, see "T-STORE" on page 92.

Listening to stored stations

- Select the desired memory bank (see page 87).
The tuner display displays the frequencies or names of the six stations **Ⓒ** assigned to the softkeys **Ⓗ** to **Ⓛ** in this memory bank.
- Briefly press the softkey which is assigned to the station you want to set up.
The frequency or the name of the current station is indicated.

The selected station is played back provided that it can be received at the current vehicle position.

The station name or the frequency of this station appears on the main line **Ⓐ** if the station provides this RDS information. In addition, the memory location of the radio station **Ⓒ** is highlighted.

Scanning all receivable stations (SCAN)

- Select the waveband (FM, MW, LW) whose receivable stations you want to scan (see page 91).
- Press and hold the **OK** button **Ⓜ** for approx. two seconds.

The tuner searches for stations in the current waveband. The main line **Ⓐ** displays "SCAN" every two seconds.

As soon as the tuner has located a station, it is played and the station name or the station frequency appears on the main line **Ⓐ**. The scan time can be set as described on page 123 and 124 under "SCANTIME".

After the frequency band has been completely searched once, the search stops and the station located last is played back.

You can do the following at any time:

- store the currently scanned station (see page 89),
- cancel the scan by briefly pressing the **OK** button (17).

Set the device to the region Europe, USA or Thailand

The device is factory set to the frequency ranges and station technologies of the region in which it was purchased. If this setting is not correct, you can adjust the device as follows to the different frequency ranges and station technologies of Europe, the United States or Thailand.

- Switch off the device.
- Hold the two softkeys (9) and (12) pressed while switching on the radio.

The "AREA" menu opens.

- Press the softkey next to the region in which you are using the device.
- Press the **OK** button (17).

Changing the tuner settings ("TUNER" menu)

The "TUNER" menu allows you to change the basic settings of the tuner. To open the "TUNER" menu:

→ Press the **TUNER** button (2).

The menu consists of two pages ("FM TUNER MENU1" and "FM TUNER MENU2") which can be toggled with the **NEXT** button (6).

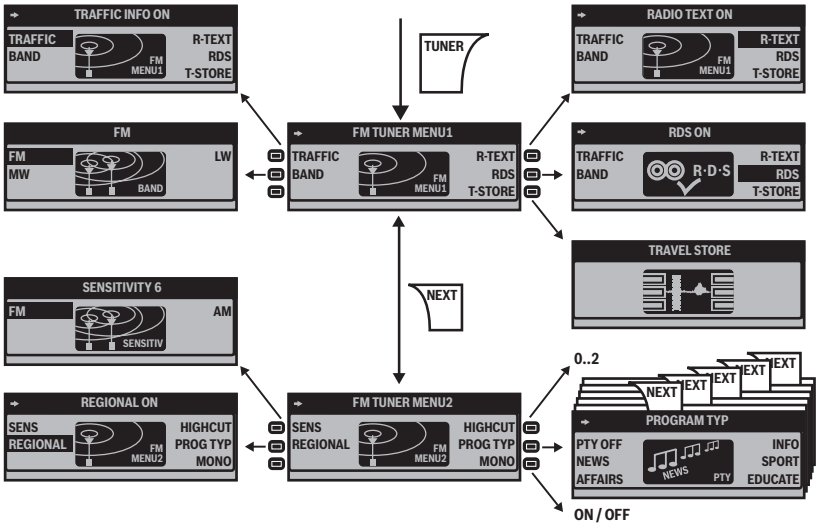

Permanently switching the priority of traffic announcements on/off (TRAFFIC)

See page 96.

Changing the waveband (BAND)

The tuner can receive FM, AM, and LW. To switch between these wavebands:

→ In the "TUNER" menu, press the softkey (7) (next to "BAND").

→ Select the desired band by pressing the corresponding softkey.

- FM
- AM
- LW

You can now do the following in this waveband:

- Searching stations (page 87).
- Storing stations (page 89).
- Calling up stored stations (page 89).

Switching the display of radio text on/off (R-TEXT)

→ In the "TUNER" menu, press the softkey **12** (next to "R-TEXT").

- "R-TEXT ON": The radio text display is switched on. Radio text is displayed on info line 2 **E** of the tuner display, provided that the station broadcasts radio text.
- "R-TEXT OFF": The radio text display is switched off.

Allowing alternative frequencies (RDS)

The device can automatically switch to an alternative frequency (AF) of the same station if the reception becomes poor.

→ Press the softkey **11** in the "TUNER" menu (next to "RDS").

- "RDS ON": The device automatically adjusts the best receivable frequency of the station, provided that the station supports the "AF" RDS function.
- "RDS OFF": The device does not change the frequency.

Searching FM stations automatically and storing them in the FMT memory bank (T-STORE)

You can automatically store the six FM stations offering the strongest reception in the region in the FMT memory bank.

→ In the "TUNER" menu, press the softkey **10** (next to "T-STORE").

The main line **A** displays "TRAVEL STORE...". The tuner automatically searches the six strongest FM stations and stores them in the FMT memory bank. After the storing is completed, the radio plays the station at memory location 1 of the FMT level. Stations that were previously stored in the FMT memory bank are automatically deleted.

Changing the seek tuning sensitivity (SENS)

The seek tuning sensitivity determines whether the automatic station seek tuning locates only strong stations or also weaker stations, which may be degraded by a high noise level.

→ Change to the second page of the "TUNER" menu by pressing the **NEXT** button **6**.

→ In the "TUNER" menu, repeatedly press the softkey **9** (next to "SENS").

- The "SENSITIVITY" menu appears.
- Press the softkey ⑦ (next to "FM") to set the seek tuning sensitivity for FM stations or press the softkey ⑫ (next to "AM") to set the seek tuning sensitivity for AM stations. Each seek tuning sensitivity can be adjusted in six increments.
- "1": Low seek tuning sensitivity. During a station seek tuning (see page 87), only local strong stations are found.
 - "6": High seek tuning sensitivity. Poor, remote stations are also found.

Allowing/preventing automatic changing to other regional programmes (REGIONAL)

Some stations divide their programmes into regional programmes with different contents at certain times. You can use the Regional function to prevent or allow the device from switching to alternative frequencies that are transmitting a different programme content.

- Change to the second page of the "TUNER" menu by pressing the **NEXT** button ⑥.

- Press the softkey ⑧ in the "TUNER" menu (next to "REGIONAL").
- "REGIONAL ON": The Regional function is switched on. The tuner does not even switch to other regional programmes if the reception quality becomes poor.
 - "REGIONAL OFF": The Regional function is switched off. The tuner switches to other regional programmes if the reception of the current programme is too poor.

Activating/deactivating improved reception (HIGH CUT)

The High Cut function results in an improved reception in case of weak radio reception (FM only).

- Change to the second page of the "TUNER" menu by pressing the **NEXT** button ⑥.
- In the "TUNER" menu, repeatedly press the softkey ⑦ (next to "HIGH CUT").
- "1": The High Cut function is switched on and has a low response sensitivity. If the reception is very poor, the interference level is automatically decreased.
 - "2": The High Cut function is switched on and has a high response sensitivity. If the reception is poor, the interfer-

ence level is automatically decreased.

- "0": The High cut function is switched off.

Restricting station seek tuning to certain programme contents (PROG TYP)

- Change to the second page of the "TUNER" menu by pressing the **NEXT** button (6).
- In the "TUNER" menu, press the softkey (12) (next to "PROG TYP").
- Scroll through the pages of the programme types with the **NEXT** button (6).
- Press the softkey next to the desired programme type.
- Next, start a station seek tuning (see page 87).

Toggle between mono and stereo operation (MONO)

If you selected the "FM" waveband, you can toggle between mono and stereo operation.

- Change to the second page of the "TUNER" menu by pressing the **NEXT** button (6).
- Press the softkey (9) in the "TUNER" menu (next to "MONO").
 - "MONO ON": The mono operation is activated. Weak,

noisy stations are played back more clearly.

- "MONO OFF": The stereo operation is activated. You are listening in stereo if the station broadcasts in stereo.

Note:

If you switch on the device, this setting is automatically set to stereo operation.

Traffic announcements (TA)

The device uses the RDS services TA and EON to play traffic announcements even if you are currently listening to another audio source. If you did not define a traffic information station, the device can automatically switch to a traffic information station of the same broadcasting network for the duration of a traffic announcement.

Receiving traffic announcements

As soon as the device receives a traffic announcement:

- The traffic announcement is switched through using the volume defined in the settings menu (see "TRAFFIC" on page 117).
- The traffic information display appears for the duration of the traffic announcement.



For the device to switch through traffic announcements:

- The priority of traffic announcements must be switched on (see page 96).
- A traffic information station must be set or it must belong to the same broadcasting network as the current station.

Skipping a traffic announcement

To cancel a traffic announcement without switching off the priority of traffic announcements:

→ Press the softkey  (next to "TA EXIT").

The current traffic announcement is cancelled. The previously active audio source is played again and the corresponding display appears. If a traffic announcement is broadcast again, the device automatically switches it through again.

Permanently switching the priority of traffic announcements on/off

The priority of traffic announcements is switched on if the "TRAFFIC" menu item (on the display of the audio source or in the "TUNER" menu) is highlighted.

You have two options to switch the priority of traffic announcements on or off:

On the traffic information display

→ Press the softkey **7** (next to "TA OFF") during the traffic announcement.

The current traffic announcement is cancelled. The previously active audio source is played again and the corresponding display appears. If a traffic announcement is broadcast again, the device does **not** automatically switch it through.

On the display of the audio source or in the "TUNER" menu (TRAFFIC)

The "TRAFFIC" menu item is shown on the display of the audio source or in the "TUNER" menu.

→ Press the softkey **9** (next to "TRAFFIC").

The status is briefly displayed on the main line **A**.

- "TRAFFIC INFO ON": Traffic announcements are automatically switched through.
- "TRAFFIC INFO OFF": Traffic announcements are **not** switched through.

Operating the integrated CD player

The device can play the following CD formats:

- CD audio (some CDs with copy protection cannot be played)
- CD-R or CD-RW with MP3 or WMA files (without DRM copy protection only)

Note:

The quality of self-burnt CDs fluctuates due to different CD blanks, CD burner software, and burn speeds. For this reason, it is possible that the device cannot play some self-burnt CDs.

If you cannot play a CD-R/CD-RW:

- Use blanks from a different manufacturer or a different colour,
- burn CD-Rs at a lower speed.

What features do MP3 or WMA CDs have to have?

The device can only play and display MP3 or WMA CDs with the following features:

- The CD-ROM may contain only MP3 or only WMA files as well as folders, but no other files (including no CD audio files).
- CD format: ISO 9660 (Level 1 or 2) or Joliet

- Bit rate:
MP3: max. 320 kbit/s
WMA: max. 768 kbit/s
- File extension: Must be ".MP3" or ".WMA"
- ID3 tags: Version 1 or 2
- Max. 252 folders per CD with max. 999 MP3 files per folder (fewer in case of long file names: approx. 700 at 20 characters per file name)
- File names may not contain an umlaut or special character and may not be longer than 32 characters.
- WMA files with DRM (Digital Rights Management, copy protection/playback restrictions), which are offered for download, for example, by music providers on the Internet, cannot be played by the device. WMA files which you create yourself, e.g. from CD audio files, can be played.

Functions of the integrated CD player if an audio CD is inserted

After inserting an audio CD (see page 76) and selecting "CD" as the audio source for the first time (see page 79), "CD Reading" briefly appears on the main line (A). Next, the audio CD display appears (see page 80). The playback starts.

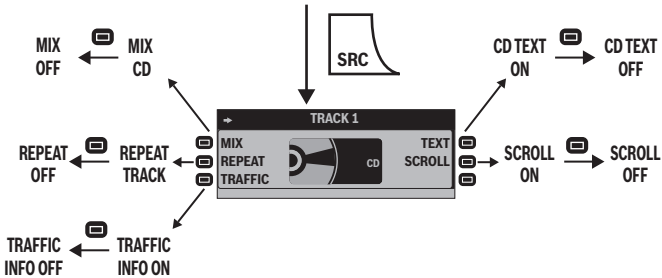

Menu item	Abbr.	Softkey	Setting option	See also
Random track play	MIX	⑦	Switch-on (MIX CD) Switch-off (MIX OFF)	Page 83
Repeat title	REPEAT	⑧	Switch-on (REPEAT TRACK) Switch-off (REPEAT OFF)	Page 84
Priority for traffic announcements	TRAFFIC	⑨	Switch-on (TRAFFIC INFO ON) Switch-off (TRAFFIC INFO OFF)	Page 95
Display CD text	TEXT	⑫	Switch-on (CD TEXT ON) Switch-off (CD TEXT OFF)	Page 99
Scrolling text	SCROLL	⑪	Switch-on (SCROLL ON) Switch-off (SCROLL OFF)	Page 99

Switching the CD text display on/off (TEXT)

Some CDs support the display of text information about artist, album, track, etc. To switch the display of CD text on/off:

→ Press the softkey **(12)** (next to "TEXT").

The CD text status is briefly displayed on the main line **(A)**:

- "CD TEXT ON": The CD text is displayed on info line 2 **(E)**.
- "CD TEXT OFF": The CD text is not displayed.

Switching the scrolling text for CD text on/off (SCROLL)

The device can display CD text statically or as scrolling text (Scroll). To change the display of CD text:

→ Press the softkey **(11)** (next to "SCROLL").

The CD text display status is briefly displayed on the main line **(A)**:

- "SCROLL ON": CD text is displayed as scrolling text, provided that the CD supports CD text, the display of CD text is switched on (see the previous section), and the CD text does not fit on info line 2 **(E)** of the display.

Operating the MP3/WMA player

After inserting a medium with MP3 or WMA files (CD, MMC/SD card, or USB stick) (see pages 76 and 77) and selecting them as audio source for the first time (see page 79), "CD/MMC/USB Reading" appears on the main line (A). Next, the MP3 display appears (see page 81). The playback starts.

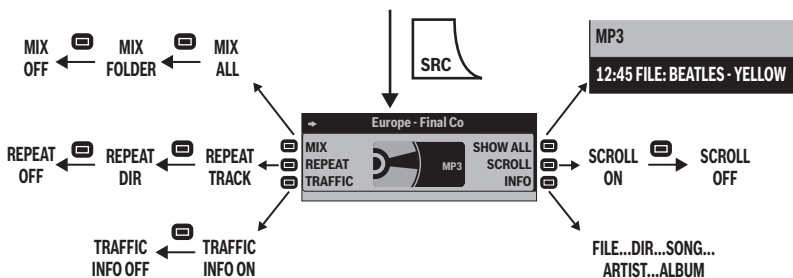

Menu item	Abbr.	Softkey	Setting option	See
Random track play	MIX	(7)	Playing files of the folder (MIX FOLDER) or data carrier (MIX ALL) in random order Switch-off (MIX OFF)	Page 83
Repeat title	REPEAT	(8)	Repeating the current file (REPEAT TRACK) or files of the folder (REPEAT DIR) Switch-off (REPEAT OFF)	Page 84
Priority for traffic announcements	TRAFFIC	(9)	Switch-on (TRAFFIC INFO ON) Switch-off (TRAFFIC INFO OFF)	Page 95
Showing infos	SHOW ALL	(12)	All available information for the current title scrolls once on info line 2 (E)	Page 101
Scrolling text	SCROLL	(11)	Switch-on (SCROLL ON) Switch-off (SCROLL OFF)	Page 101
Selecting info	INFO	(10)	Switching between DIR, SONG, ARTIST, ALBUM, and FILE	Page 101

Showing all the information of the current title (SHOW ALL)

To show all the available information about the current title (e.g. from ID3 tags) on the info line 2 (E):

→ Press the softkey (12) (next to "SHOW ALL").

All available information for the current title scrolls once on info line 2 (E).

Switching scrolling text on/off (SCROLL)

The device can display the title information selected in the "INFO" menu item (see next section), either statically or as scrolling text.

To toggle between static display and scrolling text:

→ Press the softkey (11) (next to "SCROLL").

- If the scrolling text display is switched on, the text scrolls without interruption from right to left on info line 2 (E).
- If the scrolling text display is switched off, the text scrolls once from right to left on info line 2 (E). Afterwards, up to the first 13 characters are displayed.

Selecting the title information to be displayed (INFO)

The device can display the following title information on info line 2 (E):

- Either information from embedded data or ID3 tags (artist, title, album, genre, year), if available
- Or file and folder name.

To select the title information to be displayed:

→ Press the softkey (10) repeatedly (next to "INFO").

The type of information to be displayed is shown:

- "DIR": Name of the folder in which the currently playing file is located
- "SONG": Name of the current title
- "ARTIST": Name of artist
- "ALBUM": Name of album
- "FILE": File name of current title

Selecting a title from a list (Browser mode/playlist)

During the MP3 or WMA playback, you can always switch between the following modes using the **NEXT** button (6):

- MP3 display (left part of the figure)
- Browser mode (center part of the figure)
- Playlist mode (right part of the figure)

Note:

The device can play playlists that were created with an MP3 manager, such as WinAmp or Microsoft Media Player. These playlists must be present in the format M3U, PLS or RMP and stored in the root directory of the data carrier!

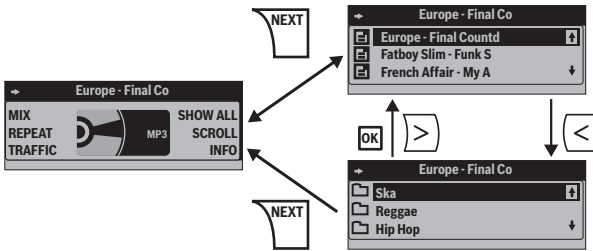

The browser mode or the playlist shows:

- the currently playing file on the main line (A),
- the next three files to be played below it,
- two arrows on the right side which appear if you can scroll in the corresponding direction.

Note:

The files are not played in alphabetical order, but in the order in which they were physically stored on the data carrier. This order is also displayed in the browser mode.

In the browser mode and the playlist mode, you can select files or folders from the list as follows:

- On the rocker switch (3), press $\bar{\Delta}$ or ∇ to scroll up or down.
- On the rocker switch (3), press $<$ to change up to a higher-level folder.
- Press the **OK** button (17) to change down to a selected subfolder.
- Press the **OK** button (17) to play a selected file.

Operating the optional CD changer

After inserting at least one CD in the CD changer magazine and selecting "CDC" as the audio source for the first time (see page 79), "Magazine Scan" briefly appears on the display. The CD overview appears next. The playback starts.

You can toggle between the CD overview (top part of the figure) and the CD changer display (center part of the figure) by using the **NEXT** button ⑥.

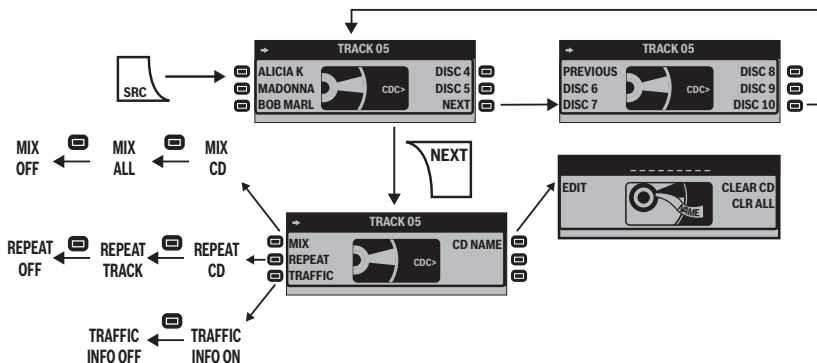

Menu item	Abbr.	Softkey	Setting option	See
Random track play	MIX	⑦	Playing all the titles of the CD (MIX CD) or the magazine (MIX ALL) in random order Switch-off (MIX OFF)	Page 83
Repeat title	REPEAT	⑧	Repeating the current title (REPEAT TRACK) or the current CD (REPEAT CD) Switch-off (REPEAT OFF)	Page 84
Traffic announcements	TRAFFIC	⑨	Switch-on (TRAFFIC INFO ON) Switch-off (TRAFFIC INFO OFF)	Page 95
Editing CD names	CD NAME	⑫	Entering, changing, deleting names for CDs located in the changer magazine	Page 105

Selecting a CD from the CD magazine (CD overview)

The CD overview shows:

- Either the CD number (e.g. "DISC 01")
 - or the name of the CD (you can enter it as described in the next section)
 - or an empty position if the corresponding position of the magazine is without a CD.
- If necessary, press the **NEXT** button (6) to display the CD overview.
- Press the softkey located next to the number or next to the name of the desired CD.

The main line (A) briefly displays "LOADING CD". The playback starts next with the first track of the CD.

Note:

If there are more than five CDs in the magazine of your CD changer, press softkey (10), which is also located next to the menu items "NEXT" and "PREVIOUS", to toggle between the display of the first and last five CDs.

Changing the name of a CD in the magazine of the CD changer (CD NAME)

You can assign a name to every CD located in the CD changer. The name can have up to seven characters.

- Select the CD to which you want to assign a name in the CD overview as described in the preceding section.
- Press the **NEXT** button (6) to show the CD changer display.
- Press the softkey (12) (next to "CD NAME").
- Press the softkey (7) (next to "EDIT").

The text input appears. The first character of the name is flashing.

- On the rocker switch (3), repeatedly press $\bar{\Delta}$ or ∇ to change the flashing character.
- On the rocker switch (3), press > to change to the next character.
- Press the **OK** button (17) to finish the text input and to store the name entered.

Note:

To quit the text input without changing the name, press the **ESC** button (16).

Changing basic settings in the settings menu

To delete the name of the current CD:

- Press and hold the softkey **12** (next to "CLEAR CD") for longer than two seconds.

The main line **A** briefly displays "CLEARING".

To delete the names of all the CDs located in the magazine of the CD changer:

- Press and hold the softkey **10** (next to "CLR ALL") for longer than two seconds.

The main line **A** briefly displays "CLEARING".

Changing basic settings in the settings menu

The settings menu allows you to adjust basic device functions, such as sound, power-on volume or display brightness, to your specific needs.

To open the settings menu:

- Press the **MENU** button **15**. The settings menu appears.

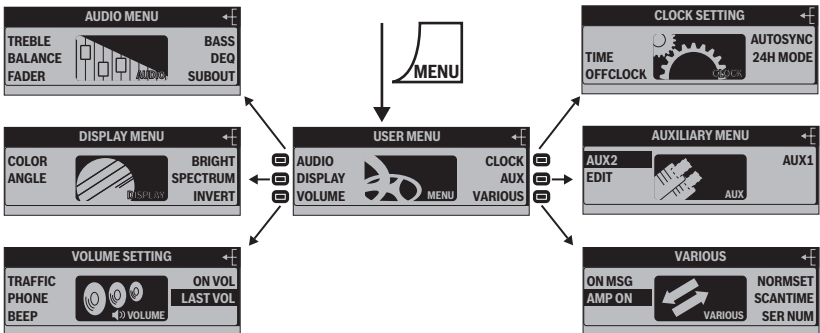

Adjusting sound and balance (AUDIO)

The "AUDIO" menu provides extensive possibilities for adjusting the sound to your specific needs.

→ Press the **MENU** button (15). The settings menu appears.

→ Press the softkey (7) (next to "AUDIO").

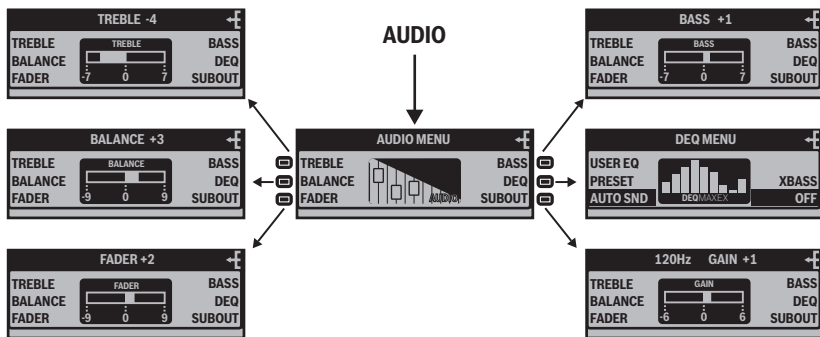

Changing treble or bass (TREBLE/BASS)

→ Press the softkey (7) (next to "TREBLE") or the softkey (12) (next to "BASS").

The corresponding sound control is displayed.

→ On the rocker switch (3), press $\bar{\wedge}$ or $\bar{>}$ to increase treble or bass.

→ On the rocker switch (3), press $\bar{\vee}$ or $\bar{<}$ to decrease treble or bass.

Changing the volume distribution (BALANCE/FADER)

The balance controls the volume distribution between left and right, the fader between front and rear.

→ Press the softkey (8) (next to "BALANCE") or softkey (9) (next to "FADER").

The volume distribution is displayed.

→ On the rocker switch (3), press on the desired direction.

The volume distribution changes. The display shows the new volume distribution.

Changing the equalizer setting (DEQ)

Your device features a digital 6-band equalizer. On the "DEQ" menu, you can adjust the sound to your vehicle and your specific needs and eliminate problems, such as droning or poor voice comprehension.

- Press the **MENU** button (15). The settings menu appears.
- Press the softkey (7) (next to "AUDIO SETTINGS"). The "AUDIO" menu appears.
- Press the softkey (11) (next to "DEQ").

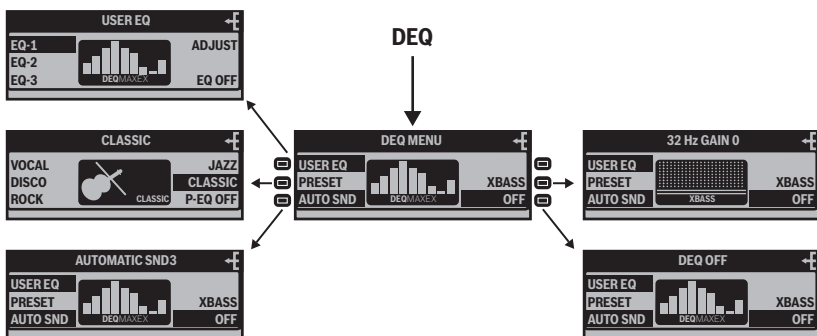

Calling up a user-defined equalizer setting (DEQ)

In the "DEQ" menu, you can create, store and call up up to three user-defined equalizer settings ("EQ-1" to "EQ-3").

To call up one of the three user-defined equalizer settings:

- Press the softkey (7) (next to "USER EQ").
The "USER EQ" menu appears.

- Press one of the three softkeys (7) to (9) (next to "EQ-1", "EQ-2" or "EQ-3").

The selected user-defined equalizer setting is highlighted. The sound changes accordingly.

- To turn the equalizer off, press the softkey (10) (next to "P-EQ OFF") instead.

Creating/changing a user-defined equalizer setting (ADJUST)

You can adjust the three different user-defined equalizer settings to different situations, e.g. for the driver alone, for driver and passenger or for passengers in the front and the rear.

- Select the user-defined equalizer setting which you want to create/change as described in the preceding section.
- Press the softkey  (next to "ADJUST"). The "USER EQ ADJUST" menu opens.

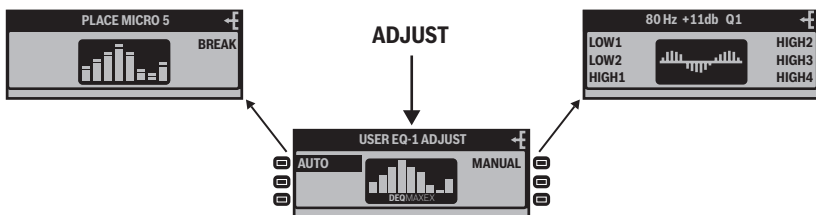

AUTO:

You can automatically create **one** of the three equalizer settings using a measurement microphone (available as an accessory).

Before starting, ensure the following:

- The measurement microphone must be connected before installing the device as described in the installation instructions of the measurement microphone.
- There must be true silence during the measurement since external noise falsify the measurement. For this reason, close all windows, doors, and the sliding sunroof.

Switch off the engine, but leave the ignition switched on.

- The temperature inside the vehicle must be below 55 °C.
 - All the loudspeakers must be connected. The sound radiating from the loudspeakers must not be obstructed by any objects.
- Position the measurement microphone
- for the driver only – 10 cm next to the right ear of the driver,
 - for driver and passenger – exactly between both at the head level,

- for passengers in the front and rear – at the head level in the center of the vehicle.
- Ensure that all passengers in the vehicle are sitting and remaining quiet.
- Change to the "DEQ" menu and call up one of the user-defined equalizer settings ("EQ-1" to "EQ-3") as described in the preceding section.
- Open the "USER EQ ADJUST" menu as described on page 109.
- Press the softkey **7** (next to "AUTO") and follow the instructions on the display.

After a 5-second countdown, you hear the test noise and the main line **A** intermittently shows "SILENCE PLEASE" and "ADJUSTING".

The automatic equalizer setting finishes successfully if "ADJUSTMENT OK" appears on the main line **A**. The equalizer setting is saved. Any previously stored setting under this equalizer setting is overwritten. The new setting can now be called up under the corresponding equalizer setting ("EQ-1" to "EQ-3").

MANUAL:

As an alternative, you can manually create the equalizer setting without measurement microphone. In each of the six frequency bands, you can select one specific individual centre frequency and finely adjust its level and quality factor Q.

- Insert a CD with which you are very familiar.
- Adjust bass, treble, balance, and fader to zero.
- Open the "USER EQ ADJUST" menu as described on page 109.
- Press the softkey **12** (next to "MANUAL").
- First, select a frequency band to be changed. First, change the centre, then the treble, followed by the bass.
 - "LOW1" to "2": To change the bass (20 to 250 Hz).
 - "HIGH1" to "4": To change the centre or treble (320 to 20,000 Hz).

The frequency spectrum is displayed. If you already changed the level in another frequency band, this change is visible in the frequency spectrum. The current centre frequency (Hz) is highlighted.

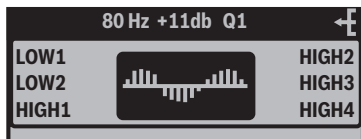

→ Select the centre frequency to be changed by pressing on $\bar{\wedge}$ or \vee on the rocker switch (3).

In the two frequency bands "LOW1" and "2", you can select one centre frequency each from 20 to 250 Hz. In the four frequency bands "HIGH1" to "4", you can select one centre frequency each from 320 to 20,000 Hz.

→ On the rocker switch (3), press $>$.

The level display (dB) is highlighted.

→ Select the level of the previously set centre frequency by pressing on $\bar{\wedge}$ or \vee on the rocker switch (3).

The level change is displayed in the frequency spectrum. The sound changes accordingly.

→ On the rocker switch (3), press $>$.

The quality factor Q is highlighted.

→ Select the desired quality factor Q by pressing on $\bar{\wedge}$ or \vee on the rocker switch (3).

- "Q1": Low edge steepness, wide filter bandwidth
- "Q2": Medium edge steepness and filter bandwidth
- "Q3": High edge steepness, narrow filter bandwidth

The change is displayed in the frequency spectrum. The sound changes accordingly.

→ Press the **OK** button (17).

Your user-defined equalizer setting is saved.

Which equalizer setting is the correct one?

Sound impression or problem	Measure	
	Centre frequency (Hz)	Level (dB)
Unclean bass, droning, unpleasant pressure	125–400	approx. -4
Very transparent, aggressive sound, no stereo effect	1000–2500	approx. -4 to -6
Muffled sound, low transparency, instruments do not excel	8000–12500	approx. +4 to +6
Insufficient bass	50–100	approx. +4 to +6

Selecting a sound presetting (PRESET)

This menu item allows you to select one of the following sound presets: VOCAL, DISCO, ROCK, JAZZ or CLASSIC.

→ Press the softkey located next to the desired sound preset.

The selected sound preset is highlighted and shown on the main line (A).

→ To turn the equalizer off, press the softkey (10) (next to "P-EQ OFF") instead.

Setting the speed-dependent volume increase (AUTO SND)

When you are driving faster, the device can automatically increase the volume to compensate for the driving noise. In order for this to work, the speedometer signal must be connected as described in the installation instructions. You can adjust this volume increase from 0 (no increase) to 5 (maximum increase).

→ Repeatedly press the softkey (9) (next to "AUTO SND").

The current speed-dependent volume increase is shown on the main line (A).

Note:

If no increase is set, the main line (A) shows "AUTO SND OFF".

→ On the rocker switch (3), press $\bar{\wedge}$ or $\bar{>}$ to raise the volume increase.

→ On the rocker switch (3), press $\bar{\vee}$ or $\bar{<}$ to lower the volume increase.

Setting the bass increase (XBASS)

XBASS is a bass increase at low volume. This bass increase can be set in increments from 0 (no increase) to 6 (maximum increase) for the following frequencies: 32 Hz, 40 Hz, 50 Hz, 63 Hz, or 80 Hz.

→ Press the softkey (11) (next to "XBASS").

The "XBASS" menu item is flashing. The frequency (Hz) and bass increase (GAIN) are shown on the main line (A).

→ On the rocker switch (3), press $\bar{<}$ or $\bar{>}$ to select the desired frequency.

→ On the rocker switch (3), press $\bar{\wedge}$ or $\bar{\vee}$ to set the desired bass increase.

Configuring the preamplifier output for the subwoofer (SUBOUT)

If you want to use an additional subwoofer, it can be adjusted to the other loudspeakers.

You can adjust the level of the Subout preamplifier output in 13 increments from -6 dB (maximum decrease) to +6 dB (maximum increase) for one of the following cut-off frequencies: 80 Hz, 120 Hz, or 160 Hz.

→ In the "AUDIO" menu, press the softkey $\text{\textcircled{10}}$ (next to "SUBOUT").

The "SUBOUT" menu item is flashing. The current cut-off frequency (HZ) and the current level (GAIN) are shown on the main line $\text{\textcircled{A}}$.

→ On the rocker switch $\text{\textcircled{3}}$, press < or > to select the desired cut-off frequency.

→ On the rocker switch $\text{\textcircled{3}}$, press $\bar{\wedge}$ or $\bar{\vee}$ to set the desired level of the preamplifier output.

Switching the equalizer off (OFF)

→ In the "DEQ" menu, press the softkey $\text{\textcircled{10}}$ (next to "OFF").

Changing display settings (DISPLAY)

In the "DISPLAY" menu, you can adjust the display brightness, colour and contrast, among other things.

→ Press the **MENU** button (15). The settings menu appears.

→ Press the softkey (8) (next to "DISPLAY"). The "DISPLAY" menu appears.

The "DISPLAY" menu consists of two pages which can be toggled with the **NEXT** button (6).

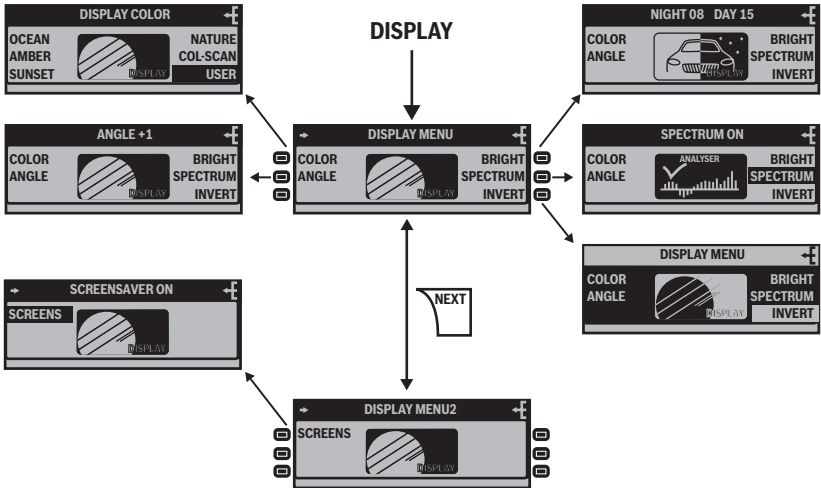

Changing the colour of the display (COLOR)

You can change the colour of the display by selecting one of the four presettings ("OCEAN", "AMBER", "SUNSET" or "NATURE") or the user-defined colour ("USER").

To select one of the four presettings:

→ Press the corresponding softkey (next to "OCEAN", "AMBER", "SUNSET", "NATURE" or "USER").

The colour of the display changes accordingly.

Changing the user-defined colour (USER)

Two options are available to change the user-defined colour.
Option 1:

- Press the softkey **(10)** (next to "USER").
- Set the desired colour using the softkeys **(7)** to **(12)**.
 - "RED-": Reduces the red portion.
 - "GREEN-": Reduces the green portion.
 - "BLUE-": Reduces the blue portion.
 - "RED+": Increases the red portion.
 - "GREEN+": Increases the green portion.
 - "BLUE+": Increases the blue portion.

The colour of the display changes accordingly.

Option 2:

- Press the softkey **(11)** (next to "COL-SCAN").
The display sequentially shows all colours that can be displayed.
- Press the softkey **(7)** (next to "SAVE") or the **OK** button **(17)** to select the colour currently displayed.

- Press the softkey **(12)** (next to "BREAK") or the **ESC** button **(16)** instead to exit the "COL-SCAN" menu item without changing the colour.

Adjusting the display viewing angle (ANGLE)

The angle at which the driver looks at the display is dependent upon, among other things, the installation position of the device, the seating position, and the physical size of the driver. You can adjust the display contrast to your viewing angle as follows.

- Press the softkey **(8)** (next to "ANGLE").
The "ANGLE" menu item is flashing. The current display contrast is shown on the main line **(A)**.
- On the rocker switch **(3)**, press **∧** or **>** to increase the display contrast.
- On the rocker switch **(3)**, press **∨** or **<** to decrease the display contrast.
You can adjust the display contrast in 13 increments from -6 to +6.

Changing the brightness of the display for day/night (BRIGHT)

See page 85.

Inverting the display (INVERT)

→ Press the softkey **⑩** (next to "INVERT").

Bright portions of the display are displayed as dark, dark portions as bright.

Switching the spectrum analyser on/off (SPECTRUM)

Instead of displaying the audio source, the device can display a 5-band spectrum analyser. For this purpose, the screen saver must be deactivated (see next section) and you must activate the display of the spectrum analyser as follows.

→ Press the softkey **⑪** (next to "SPECTRUM").

- "SPECTRUM ON": The spectrum analyser can be displayed.
- "SPECTRUM OFF": The spectrum analyser cannot be displayed.

The spectrum analyser automatically appears 16 seconds after the last button is pushed instead of the display of the audio source. You can also display the spectrum analyser manually:

→ To do so, press the **ESC** button **⑫** while the display of the audio source is shown.

→ Press any button to switch the spectrum analyser off.

Activating/deactivating the screen saver (SCREEN S)

Instead of displaying the audio source, the device can display a screen saver. For this purpose, the display of the spectrum analyser must be deactivated (see previous section) and you must activate the display of the screen saver as follows.

→ Press the **NEXT** button **⑬** to change to the second page of the "DISPLAY" menu.

→ Press the softkey **⑭** (next to "SCREEN S").

- "SCREEN SAVER ON": The screen saver starts immediately.
- "SCREEN SAVER OFF": The screen saver is not shown.

The screen saver automatically appears 16 seconds after the last button is pushed instead of the display of the audio source. You cannot display the screen saver manually:

→ Press any button to interrupt the screen saver and show the display of the active audio source again.

Changing volume presettings (VOLUME)

In the "VOLUME SETTING" menu, select the volume presettings for traffic announcements, the telephone, the signal tones, etc.

→ Press the **MENU** button (15). The settings menu appears.

→ Press the softkey (9) (next to "VOLUME").

The "VOLUME SETTING" menu appears. The volume presettings are displayed as two-digit numbers. One of the two menu items "ON VOL" or "LAST VOL" is highlighted.

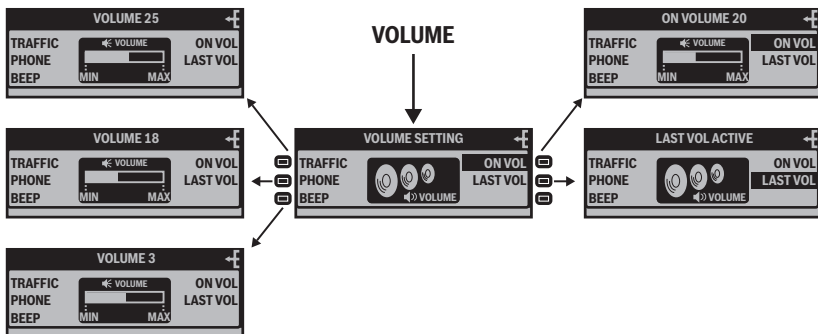

Changing the volume presetting of traffic announcements (TRAFFIC)

If the device puts a traffic announcement through, you hear it at the preset volume.

→ Press the softkey (7) (next to "TRAFFIC").

The "TRAFFIC" menu item is flashing. The volume presetting for traffic announcements is shown on the main line (A).

→ Adjust the desired volume using the volume control (5) or the rocker switch (3) (increments 1 to 50).

If a traffic announcement is broadcast, the device automatically puts it through at this volume. During the traffic announcement, you can always change the volume by means of the volume control (5).

Changing the volume presetting of the telephone (PHONE)

If the device puts a phone call through, it always starts at the preset volume.

→ Press the softkey **8** (next to "PHONE").

The "PHONE" menu item is flashing. The presetting for the telephone volume is shown on the main line **A**.

→ Adjust the desired volume using the volume control **5** or the rocker switch **3** (increments 1 to 50).

During the phone call, you can always change the volume by means of the volume control **5**.

Changing the volume presetting of the signal tone (BEEP)

If a signal tone sounds, you always hear it at the preset volume.

→ Press the softkey **9** (next to "BEEP").

The "BEEP" menu item is flashing. The presetting for the signal tone is shown on the main line **A**.

→ Adjust the desired volume using the volume control **5** or the rocker switch **3** (increments 0 to 6).

You hear a signal tone at the selected volume.

→ If you do not want to hear any signal tones, set the volume to zero.

"BEEP OFF" appears on the main line **A**.

Changing the presetting of the power-on volume (ON VOL)

You can configure the device so that the playback after switch-on always starts with the volume set here. For this purpose, the "ON VOL" menu item must be highlighted.

→ Press the softkey **12** (next to "ON VOL").

The presetting for the power-on volume is shown on the main line **A**.

→ Adjust the desired volume using the volume control **5** or the rocker switch **3** (increments 1 to 50).

The "ON VOL" menu item is highlighted.

Restoring the volume at switch-on (LAST VOL)

You can configure the device so that the playback after switch-on always starts with the previously selected volume. For this purpose, the "LAST VOL" menu item must be highlighted.

→ Press the softkey **(11)** (next to "LAST VOL").

The main line **(A)** briefly displays "LAST VOL ACTIVE".
The "LAST VOL" menu item is highlighted.

Changing clock settings (CLOCK)

In the "CLOCK SETTING" menu, you can set the clock of the device as well as change the display options of the clock.

→ Press the **MENU** button **(15)**. The settings menu appears.

→ Press the softkey **(12)** (next to "CLOCK").

The "CLOCK SETTING" menu appears.

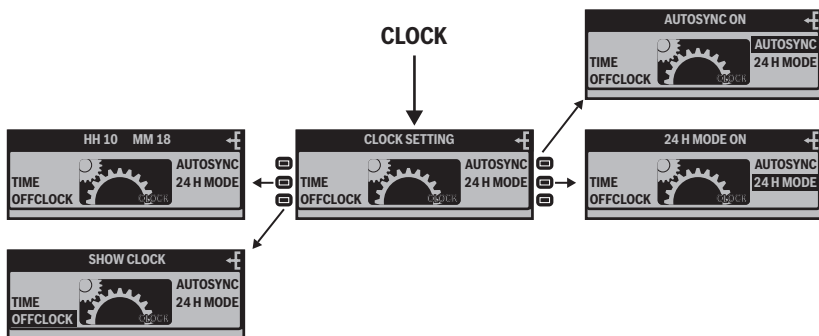

Setting the time (TIME)

→ Press the softkey (7) (next to "TIME").

The current time is shown on the main line (A). The hours flash.

→ On the rocker switch (3), press $\bar{\wedge}$ or $\bar{\vee}$ to change the hours.

→ On the rocker switch (3), press $\bar{>}$ to change to the minutes.

The minutes flash.

→ On the rocker switch (3), press $\bar{\wedge}$ or $\bar{\vee}$ to change the minutes.

→ Press the **OK** button (17) to finish the input and to save the time.

Note:

To quit the input without changing the time, press the **ESC** button (16).

Switching the time display on/off with switched-off device (OFFCLOCK)

The time can be displayed while the device is switched off, if the vehicle ignition is switched on. To switch this time display on/off:

→ Press the softkey (8) (next to "OFFCLOCK").

- "SHOW CLOCK": The time display is switched on.
- "HIDE CLOCK": The time display is switched off.

Switching the RDS synchronisation of the clock on/off (AUTOSYNC)

The clock can automatically be synchronised with the RDS time signal, provided that a station is set that broadcasts this RDS time signal.

→ Press the softkey (12) (next to "AUTOSYNC").

- "AUTOSYNC ON": The synchronisation is switched on.
- "AUTOSYNC OFF": The synchronisation is switched off.

Switching the 24-hour time display on/off (24H MODE)

The time can be displayed using the 12-hour or 24-hour format. To switch between these two formats:

→ Press the softkey (11) (next to "24H MODE").

- "24H MODE ON": The 24-hour format is switched on.
- "24H MODE OFF": The 12-hour format (AM/PM) is switched on.

Configuring audio inputs (AUX)

Up to two external audio source, such as MiniDisc player or external MP3 player, can be connected to the audio inputs AUX1 and AUX2. If you are connecting a CD changer, it occupies audio input AUX1 and you can also connect AUX2.

The audio sources AUX1 and AUX2 **cannot** be operated using the Casablanca. Only the volume can be changed.

→ Press the **MENU** button (15). The settings menu appears.

→ Press the softkey (11) (next to "AUX").

The "AUXILIARY" menu appears. The audio input "AUX1" is displayed only if no CD changer is connected.

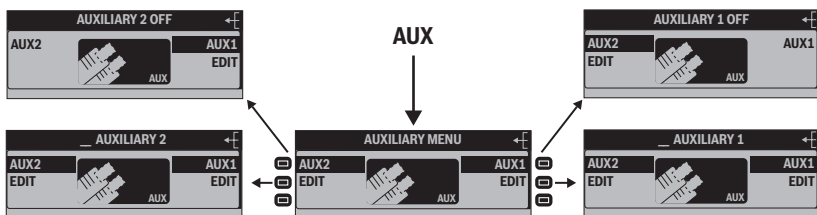

Activating/deactivating audio inputs (AUX1/2)

Audio inputs, to which you are connecting external audio sources, must be activated as follows.

→ Press the softkey (12) (next to "AUX1") and/or the softkey (7) (next to "AUX2").

The status of the audio input is shown on the main line (A):

- "AUXILIARY ON": The corresponding audio input is activated and can be selected as

audio source using the **SRC** button (18).

- "AUXILIARY OFF": The corresponding audio input is deactivated. It cannot even be selected as audio source if an external audio source is connected.

Renaming audio inputs (EDIT)

If you select an audio input as audio source, "AUXILIARY 1" or "AUXILIARY 2" appears on the main line (A). To change this name:

Note:

The "EDIT" menu item appears only if you activated the corresponding audio input as described in the preceding section.

- Press the softkey (8) for AUX2 or the softkey (11) for AUX (each next to "EDIT").

The text input for the selected audio source is shown on the main line (A). The first character of the name is flashing.

- On the rocker switch (3) repeatedly press $\bar{\Delta}$ or ∇ to change the flashing character.
- On the rocker switch (3), press $>$ to change to the next character. The name can have up to 16 characters.
- Press the **OK** button (17) to finish the text input and to store the name entered.

Note:

To quit the text input without changing the name, press the **ESC** button (16).

Changing special settings (VARIOUS)

In the "VARIOUS MENU" menu, you can change the scan time for the scan function and the welcome text.

→ Press the **MENU** button (15). The settings menu appears.

→ Press the softkey (10) (next to "VARIOUS").

The "VARIOUS" menu appears.

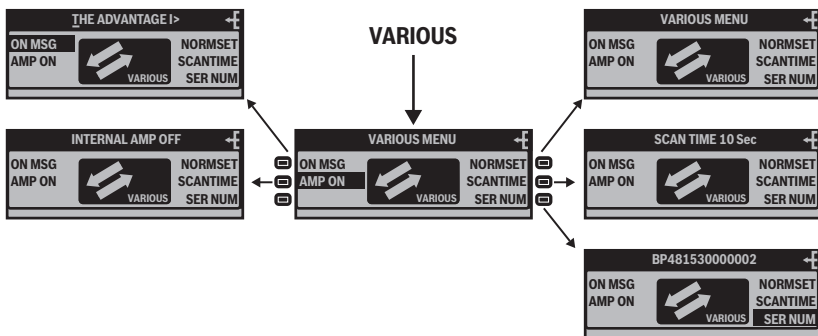

Changing the welcome text (ON MSG)

When you switch on the device, a welcome text appears. This text is factory set to "THE ADVANTAGE IN YOUR CAR!". To change this text:

→ Press the softkey (7) (next to "ON MSG").

The "ON MSG" menu item is flashing. The text input is shown on the main line (A). The first character of the welcome text is flashing.

→ On the rocker switch (3), repeatedly press $\bar{\wedge}$ or $\underline{\vee}$ to change the highlighted character.

→ On the rocker switch (3), press > to change to the next character. The welcome text can have up to 35 characters.

→ Press the **OK** button (17) to finish the text input and to store the welcome text entered.

Note:

To quit the text input without changing the welcome text, press the ESC button (16).

Switching the internal amplifier on/off (AMP ON)

If you connected the device to an external power amplifier via the preamplifier outputs (Preamp), you can switch off the internal amplifier of the device as follows:



CAUTION!

No sound with switched-off internal amplifier!

If you switch off the internal amplifier, you do not hear a sound from the loudspeakers connected to the device!

→ Switch off the internal amplifier only if you connected an external power amplifier to the preamplifier outputs (Preamp) of the device and you connected your loudspeakers to this power amplifier.

→ Press the softkey **8** (next to "AMP ON").

The status of the internal amplifier is shown on the main line **A**:

- "INTERNAL AMP ON": The internal amplifier is switched on. Loudspeakers connected to the device play back the selected audio source.

- "INTERNAL AMP OFF": The internal amplifier is switched off. Loudspeakers connected to the device always remain mute. The loudspeakers must be connected to the external amplifier.

Resetting the device to factory settings (NORMSET)

→ Press and hold the softkey **12** (next to "NORMSET") for approx. two seconds.

The main line **A** briefly displays "NORMSET ON". The device is reset to the factory settings.

Changing the scan time (SCANTIME)

→ Press the softkey **11** (next to "SCANTIME").

The "SCANTIME" menu item is flashing. The current scan time is shown on the main line **A**.

→ On the rocker switch **3**, repeatedly press $\bar{\wedge}$ or $>$ to increase the scan time.

→ On the rocker switch **3**, repeatedly press $\underline{\vee}$ or $<$ to decrease the scan time.

You can adjust scan times in increments of 5 seconds from 5 to 30 seconds.

Displaying the serial number (SER NUM)

Every device has a separate serial number. To display this number:

→ Press the softkey **10** (next to "SER NUM").

The serial number is shown on the main line **A**.

Error table

If the device does not function properly, switch the device off and on again.

If problems still persist, you can easily correct the following problems.

Problem	Possible cause	Possible remedy
The menus do not appear as shown in these instructions. The tuner cannot be adjusted to the frequencies listed in the technical data.	The device is not set to your region.	Set the device to your region as described on page 90.
The display shows information about the device.	The demo mode is activated.	Briefly press the MENU button 15 . Press and hold this button again for four seconds.
The device is always silent, even though it is correctly connected.	The internal amplifier is switched off.	Switch on the internal amplifier as described on page 124.

If problems still persist, please contact an authorised workshop or the Blaupunkt customer service (see the last page).

Technical data

Weight	approx. 1.5 kg
Voltage supply Operating voltage:	10.5–14.4 V
Current consumption In operation: 10 seconds after switch-off:	max. 10 A < 3.5 mA
Amplifier output power acc. to DIN 45324: at 14.4 V: max. power:	4 x 25 W sine 4 x 45 W at 14.4 V
Preamplifier output (Preamp Out) 4 channels:	3 V
Input sensitivity AUX inputs: Telephone input:	2 V / 6 k Ω 10 V / 1 k Ω
Tuner FM waveband: AM waveband: LW waveband: FM frequency response:	87.5–108 MHz 531–1602 kHz 153–279 kHz 35–16,000 Hz
CD player Frequency response:	20–20,000 Hz
Subject to technical changes!	

Glossary

AF – Alternative frequency

The range of FM stations is limited. For this reason, FM programmes are distributed to different frequencies. The AF RDS service sends these frequencies to the tuner. If the reception deteriorates because the vehicle leaves the reception area of a frequency, the tuner can automatically change to the best receivable frequency.

DEQmaxEx – Digital parametric equalizer with variable filter quality

This function allows for a maximum of exact frequency optimisation, so that the sound spectrum can be adjusted to the vehicle or your individual taste.

EON – Enhanced Other Network

In case of a traffic announcement (TA), the device switches from a non-traffic information station to a traffic information station of the same broadcasting network (e.g. from NDR 3 to NDR 2). After the traffic announcement, the system switches back to the previously heard programme.

Quality factor Q

It determines the filter quality of the equalizer, i.e. the edge steepness and filter bandwidth, dependent upon the characteristic frequency.

ID3 tags

ID3 tags contain additional information for MP3 files (e.g. artist, title, album, genre, year).

Mass storage device

Format for storage media that can permanently store large amounts of data, such as USB removable storage devices (USB stick or USB hard disk).

MMC/SD card (Multimedia Card/ Secure Digital Card)

MMC/SD cards are memory card formats that can be inserted in card slot ⑳ of the device. The device can play MP3 and WMA files stored on the memory cards.

MP3, WMA

MP3 and WMA are audio data formats that allow for high compression with little loss in quality.

Playlist

Playback list for MP3 or WMA files. In playlists, you determine the order in which certain titles should be played. They are created with an MP3 manager, such as WinAmp or Windows Media Player.

PTY – Program Type

The device searches only for stations with preselectable programme content (e.g. news, rock, pop, sports, etc.)

The device automatically switches through emergency and disaster announcements (PTY 31).

RDS – Radio Data System

RDS is a service of the radio stations. Besides the conventional music and voice contributions, additional information is broadcast in the form of encrypted digital signals which can be analysed by the device.

Note:

The RDS services are not supported by all radio stations!

REG – Regional

Activating the regional service (REG ON) prevents switching over to a frequency with better reception of the adjacent regional programme. This allows for continuously a regional programme even in peripheral regions.

The disadvantage is that the station may not be received without interferences.

Root directory

Main directory of a data carrier. The root directory contains all other directories.

Subwoofer, Subout

Separate low-bass loudspeaker. The device has a Subout preamplifier output. You can connect either an active subwoofer or a separate power amplifier with subwoofer.

TA – Traffic Announcement

The device switches traffic announcements through, even if you are currently listening to other sources (e.g. CD, AUX) or the radio is muted.

TMC – Traffic Message Channel

RDS data service for area-based traffic announcements. Digital traffic information data channel with continuously updated data about the traffic situation. TMC receivers allow for a selection of the data flow with respect to direction of travel, area or type of street. With a push of a button, you have access to the most current tailor-made information at all times.

Your device has a TMC output, which you can use for connecting Blaupunkt navigation systems. Please contact your authorised Blaupunkt dealer for additional information.

T-STORE – Travelstore

Automatic searching and storing of the six strongest radio stations received of the region.

Tuner

Receiving unit of the radio.

USB – Universal Serial Bus

USB is an interface for connecting external removable storage devices to the device.

XBASS

XBASS means raising the bass at low volume. This renders the sound richer even at a low volume.

Index

Symbols

24H Mode **120**

A

ADJUST **109**

Allowing alternative frequencies **92**

Amplifier **124**

AMP ON **124**

ANGLE **115**

AREA **90**

AUDIO **107**

Audio inputs

 Activating **121**

 Configuring **121**

 Renaming **121**

Audio source **79**

 Tuner **87**

AUTO **109**

AUTO SND **112**

AUTOSYNC **120**

AUX **121**

B

BALANCE **107**

BAND **91**

BAND button **74, 85**

BASS **107**

Bass increase **112**

BEEP **118**

Browser **102**

Button for detaching the control panel

74

Buttons **74**

Button to eject/insert a CD **74**

C

CD

 Changing the name of a CD in the CD
 changer magazine **105**

 Inserting **76**

 Removing **76**

 Selecting from the CD changer
 magazine **105**

CD changer **104**

 Changing the name of a CD in the
 magazine **105**

 Display **81**

 Functions **104**

CD changer display **81**

CD display **80**

CD overview **105**

CD player **97**

 Display **80**

 Functions **98**

CD text **99**

Central area **80, 81**

CLOCK **119**

Clock **119**

 24-hour time display **120**

 Display with switched-off device **120**

 Setting **120**

 Synchronise with RDS **120**

COLOR **114**

Control panel **75**

Correcting errors

 Correcting **125**

Correcting malfunctions **125**

Country code **90**

D

DEQ **108**

DISPLAY **114**

Display

 Brightness **85**

 Changing the colour **114**

 Inverting **116**

 Viewing angle **115**

E

EDIT **121**

Equalizer **109, 113**

Note:

Keywords in capital letters refer to menu items.

- Calling up a user-defined setting **108**
- Creating a user-defined setting **109**
- Settings recommendations **111**
- ESC button **75, 85**
- F**
- Factory settings **124**
- FADER **107**
- FM1, FM2, FM3, and FMT **87**
- Forward **82**
- G**
- H**
- HIGH CUT **93**
- I**
- Improved reception **93**
- INFO **101**
- Info line **80, 81**
- INVERT **116**
- J**
- K**
- L**
- LAST VOL **118**
- M**
- Main line **80, 81**
- MANUAL **110**
- Memory bank **87**
- Memory card
 - Card slot **75**
 - Inserting **77**
 - Removing **77**
- Menu
 - Calling **85**
 - Changing and saving a setting **86**
 - Exiting **86**
 - Operate **84**
 - Operating example **85**
 - Selecting a menu item **85**
 - Settings menu **106**
 - Tuner menu **91**
- MENU button **75, 84**
- MIX **81, 83**
- MMC card: see Memory card
- MONO **94**
- Mono operation **94**
- MP3
 - Files on CD **97**
- MP3 display **81**
- MP3 player **101**
 - Display **81**
 - Functions **100**
- MUTE **78**
- Muting **78**
- N**
- NEXT button **74, 84, 85**
- NORMSET **124**
- O**
- OFFCLOCK **120**
- OK button **75, 82, 85**
- On/Off button **74**
- ON MSG **123**
- ON VOL **118**
- P**
- PHONE **118**
- Playlist **102**
- PRESET **112**
- PROG TYP **94**
- PTY **80, 94**
- Q**
- R**
- R-TEXT **92**
- Radiotext **92**
- Random track play **83**
- RDS **80, 92**
- Receiving a regional programme **93**
- Region
 - Adjust **90**
- REGIONAL **93**
- Repeat **83, 84**
- Repeat mode **83**
- Repeat title **84**
- Reverse **82**
- Rocker switch **74, 82**
- RPT **81, 83**

- S**
- Safety **72**
- SCAN **84**
- Scanning **84**
- SCANTIME **124**
- Scan time **124**
- SCREEN S **116**
- Screen saver **116**
- SCROLL **99, 101**
- SD card: *see* Memory card
- Seek tuning sensitivity **92**
- SENS **92**
- Serial number **125**
- SER NUM **125**
- Settings menu **106**
- SHOW ALL **101**
- Skip title **82**
- Softkey **74, 82**
- Sound **107**
 - Presetting **112**
- SPECTRUM **116**
- Spectrum analyser **116**
- SRC button **75**
- Station
 - Calling **89**
 - Scanning **89**
 - Searching **87**
 - Storing **89**
- Stereo operation **94**
- SUBOUT **112**
- Subwoofer **112**
- Switch-off **76**
- Switch-on **76**
- T**
- T-STORE **92**
- Telephone **78**
- TIME **120**
- Title information **101**
- TMC **80**
- TP **80**
- TRAFFIC **83, 117**
- Traffic announcements **83, 95**
 - Priority **91, 95**
- Travelstore **92**
- TREBLE **107**
- Tuner
 - Display **80**
 - Functions **87**
 - Menu **91**
- Tuner display **80**
- U**
- USB medium
 - Connecting **77**
- USER **115**
- V**
- VARIOUS **123**
- VOLUME **117**
- Volume **78**
 - At switch-on **118**
 - Muting **78**
 - Presetting **117**
 - Speed-dependent increase **112**
- Volume control **74**
- Volume distribution **107**
- W**
- Warranty **73**
- Waveband **91**
- Welcome text **123**
- WMA
 - Files on CD **97**
- WMA player **100**
 - Functions **100**
- X**
- XBASS **112**
- XBS **80**
- Y**
- Z**

Bitte den ausgefüllten Gerätepass sicher aufbewahren!
Please keep the filled-in radio pass in a safe place!
Prière de conserver soigneusement la carte d'autoradio remplie !
Tenete per favore il libretto di apparecchio, debitamente riempito, in un posto sicuro!
Bewaar de ingevulde apparaatpas op een veilige plaats!

Country:	Phone:	Fax:	WWW:
Germany	(D) 0180-5000225	05121-49 4002	http://www.blaupunkt.com
Austria	(A) 01-610 39 0	01-610 39 391	
Belgium	(B) 02-525 5444	02-525 5263	
Denmark	(DK) 44 898 360	44-898 644	
Finland	(FIN) 09-435 991	09-435 99236	
France	(F) 01-4010 7007	01-4010 7320	
Great Britain	(GB) 01-89583 8880	01-89583 8394	
Greece	(GR) 210 94 27 337	210 94 12 711	
Ireland	(IRL) 01-46 66 700	01-46 66 706	
Italy	(I) 02-369 62331	02-369 62464	
Luxembourg	(L) 40 4078	40 2085	
Netherlands	(NL) 0800 400 1010	0800 400 1040	
Norway	(N) 66-817 000	66-817 157	
Portugal	(P) 2185 00144	2185 00165	
Spain	(E) 902 52 77 70	91 410 4078	
Sweden	(S) 08-7501850	08-7501810	
Switzerland	(CH) 01-8471644	01-8471650	
Czech. Rep.	(CZ) 02-6130 0446	02-6130 0514	
Hungary	(H) 76 511 803	76 511 809	
Poland	(PL) 0800-118922	022-8771260	
Turkey	(TR) 0212-335 06 71	0212-346 00 40	
USA	(USA) 800-2662528	708-6817188	
Brasil (Mercosur)	(BR) 0800 7045446	+55-19 3745 2773	
Malaysia (Asia Pacific)	(MAL) +604-6382 474	+604-6413 640	

Gerätepass

Name: **Casablanca MP56**

Typ: **7 646 580 310**

Serien-Nr: **BP**

 **BLAUPUNKT**

Blaupunkt GmbH, Robert-Bosch-Straße 200, D-31139 Hildesheim

09/07 - CM-AS/SCS1

(dt, gb, fr, it, nl)



8622404838

