

Fritz Gegauf Ltd.
BERNINA Sewing Machine Factory
Steckborn - Switzerland

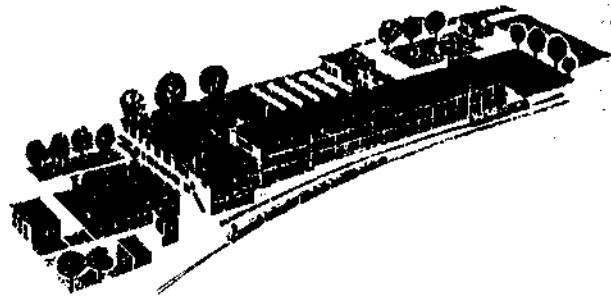

62/9 530-2/532-2 e 43206 Printed in Switzerland



200
BERNINA

Model 530-2, Bernina-Record
Automatic Zigzag Sewing Machine
with automatic buttonhole

Model 532-2
Zigzag Sewing Machine
with automatic buttonhole

INSTRUCTION-BOOK

TABLE OF CONTENTS

Guarantee	1	Lap Hemmer	38
Removing and replacing of machine	5	Hemmer	40
Electric part	12	Gathering foot	41
Bobbin Case and Bobbin	14	Edger	42
Removal of Bobbin Case	14	Zigzag Stitch	43
Spooling the Lower Thread	15	Left, middle and right-hand stitch	43
Inserting the Bobbin in the Case		Elastic Sewing of Knitted Goods	46
and Threading the Bobbin Thread		Roll Hemmer	48
Replacing Bobbin Case in Shuttle	17	Braiding	49
Needle and Thread		Buttonhole Sewing	51
Needle and Thread Selection	18	The buttonhole with cord inlay	63
Needle and Thread Table	19	Sewing on Buttons	69
Threading the Top Thread /		Darning with wool	70
Bringing up the Bobbin Thread	21	Applique Work	73
Thread Tension	22	Ornamental stitches, hand-operated	74
Cleaning and Oiling	23	The straight-sided satin stitch stop	82
Plain Stitch	28	Automatic Fancy Stitches	
Exchanging Presser Foot	28	(only applicable to Model 530-2)	83
Forward and Backward Sewing and		Blindstitch sewing	88
Adjustment of Stitch Lengths	81	Pintucking	92
Darning and Mending	83	Embroidering around holes	96
Cross-wise Darning for Linen, etc.	83	Useful Hints	100
Darning Stockings	85	Standard Accessories	Inside back cover

Accessories for model 530-2 and model 532-2

	<i>On Machine :</i>		
53 06 03 04	1 zigzag presser foot with hinged base	53 11 32	1 small screwdriver
		53 11 12	1 large screwdriver
		53 11 12	1 oiler
		53 11 18	1 brush
		53 12 00 *	1 darning attachment for stockings
			1 1/16" pintuck needle
63 06 57	1 zigzag embroidery foot, also used for braiding (1 red line)	53 06 86 02	1 pintuck foot, 7 grooves
		54 82	1 pack of needles, system 705, various sizes
53 06 08 *	1 hemmer		
53 06 13 *	1 lap hemmer		
53 06 82 03 *	1 blindstitch foot		
53 06 15 *	1 edger with quilting guide		
53 06 11 *	1 combination roll and shell-roll hemmer (2 red lines)		
53 06 20 *	1 button presser foot (2 black lines)	53 00 55	1 sewing table
		53 11 10	1 motor cable with plug
53 06 18 01	1 buttonhole foot		1 instruction book model 530-2 / 532-2
53 11 34	1 buttonhole cutter		
53 11 37	1 wooden block		
53 06 70	1 automatic darning foot		
53 06 29 01	1 wool darning foot	53 06 46 01	1 narrow hemmer
53 07 81	6 bobbins, of which one in machine	53 06 44	1 plain stitch presser foot with hinged base
		53 06 46	1 gathering foot

* Has to be charged for the model 532-2

Note

To prevent damage to presser foot, place a piece of cloth under it whenever practicable.

Place a piece of cloth under presser foot whenever machine is out of use.

In order to avoid thread jamming, make sure after every sewing operation that the take-up lever is in its raised position.

We reserve the right to change designs, specifications and accessories at any time without notice and without incurring any obligations.

Guarantee



The Warranty Certificate is sent to the Buyer direct by the Importers. Please complete and mail to them the card supplied with the machine, and they shall send you the Warranty Certificate.

Fritz Gegauf Ltd.
BERNINA Sewing Machine Factory
Steckborn - Switzerland

Terms of Guarantee

We engage to repair, free of charge, any defects due to faulty material or workmanship arising during five years in the machine, and during two years in the motor of the Bernina Model 530-2 or Model 532-2 Sewing Machine supplied by us. All other claims are excluded from this Guarantee, which is valid only towards the first buyer of the machine

This Guarantee becomes valid on the day of delivery of the machine. A buyer wishing to claim under the Guarantee should return the machine to the Bernina Dealer who sold the machine or if this is impossible to the General Agency of the country where the buyer is living or directly to the Manufacturers. Transport charges as well as any damage caused by faulty packing are at the buyer's expense.

This Guarantee does not cover normal wear and any damage ensuing therefrom, such as cable breakage, burning out of electric bulb, wear of motor carbon brushes and the like.

This Guarantee does not apply if the Instructions for use are disregarded, if the machine is not properly cleaned and lubricated, if third persons not appointed by us are allowed to effect alterations or repairs. Damage due to faulty manipulation is not covered by this Guarantee.

This Guarantee is valid only if high-grade sewing machine oil and needles System 705 (or Standard 15×1) are used.

Buyer
of
Machine

Name and Surname:

Street:

Town:

Date of delivery:

.....
(Signature of Buyer)

Supplier
of
Machine

.....
(Signature of Supplier)

Notes of Bernina Agent, concerning instructions, home calls
and possible warranty work

Date	Notes

This Instruction-Book is applicable for both, Model 530-S and Model 532-S,
with the exception of "Automatic Fancy Stitches" on page 82.

Removing and replacing

To secure safe shipping the sewing machine is fixed to the bottom of the carrying case by two screws.

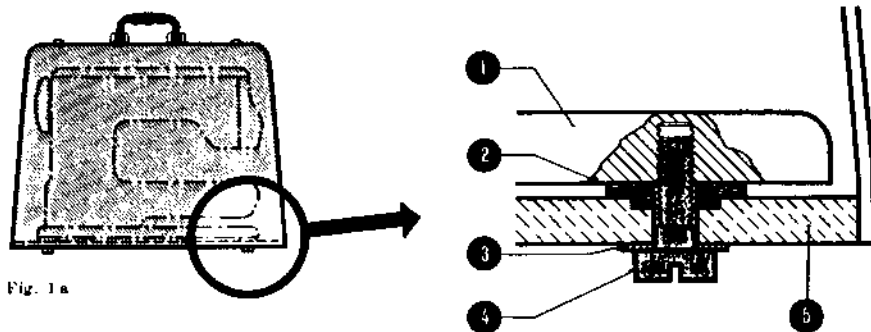

Fig. 1 a

To unpack the machine, put the carrying case on the edge of the table letting $\frac{1}{4}$ of the case project over the edge, as in Fig. 1 b. Then unscrew first fixing screw by means of a screw-driver. Turn carrying case and unscrew second fixing screw likewise.

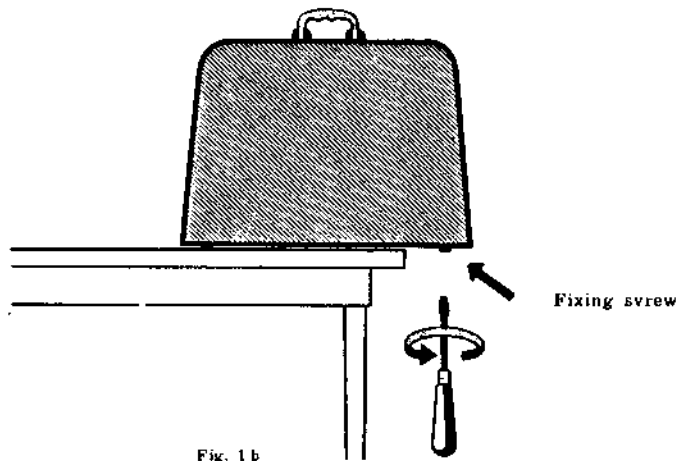

Fig. 1 b

Now the carrying case can be opened (Fig. 1 c). Grip the machine on the upper arm and take it out. When packing the machine away, be careful to have the handwheel on the correct side, as otherwise the carrying case cannot be closed. On the inside bottom of the case there is a drawing which shows how to place the machine.

The fixing screws should be kept for use when the machine at any time is sent by public transport.

Page 5 :

- Pos. 1 Base plate of machine
- Pos. 2 Rubber disc
- Pos. 3 Washer
- Pos. 4 Fixing screw
- Pos. 6 Bottom of carrying case

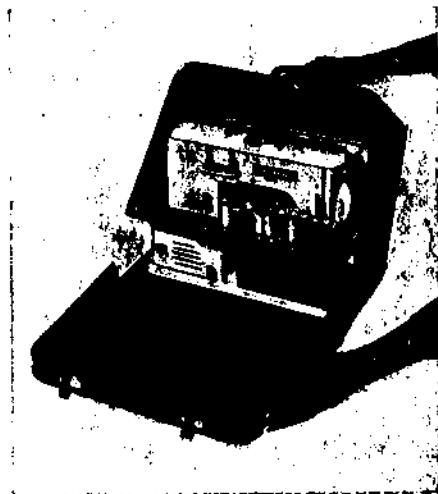

Fig. 1 c

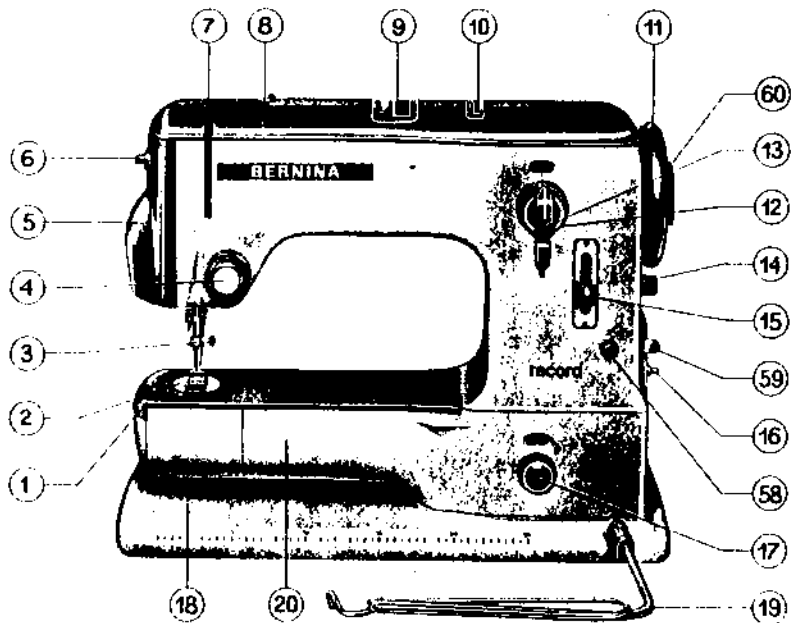

Fig. 2 on the preceding page shows a BERNINA-Record Model 530-2 knee operated; the controls referred to in the Operating Instructions being marked and identified.

- | | | | | | |
|---|-------------------------------|----|---|----|------------------------------------|
| 1 | Cover Plate | 10 | Zigzag / Ornamental
Stitch control | 16 | Bobbin Winder Shaft |
| 2 | Needle Plate | 11 | Balance wheel | 17 | Drop Feed Knob |
| 3 | Needle Holder | 12 | Zigzag, Plain Stitch and
Buttonhole sewing
Control knob | 18 | Bed Plate |
| 4 | Thread Tension | 13 | Needle Displacement lever | 19 | Knee Control Lever |
| 5 | Face Plate | 14 | Stitch - Length - Stop | 20 | Free Arm |
| 6 | Light Switch | 15 | Stitch length lever with
control knob for buttonhole | 58 | Set screw for satin
stitch stop |
| 7 | Take-up lever | 59 | Satin stitch stop lever | 60 | Balance wheel release |
| 8 | Thread Guide | | | | |
| 9 | Ornamental Stitch
Selector | | | | |

Fig. 2

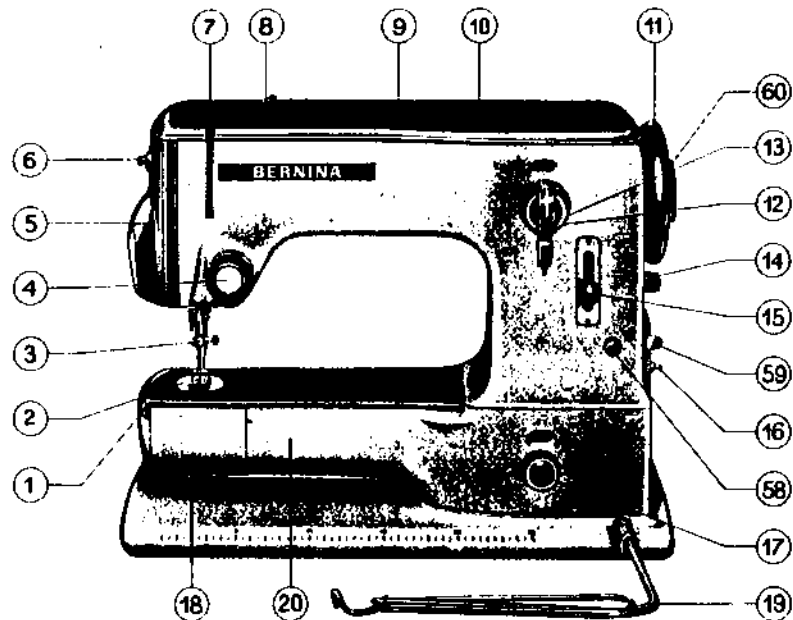

Fig. 3 on the preceding page shows a BERNINA Model 532-2 knee operated; the controls referred to in the Operating Instructions being marked and identified.

- | | | |
|-------------------------|---|---|
| 1 Cover Plate | 11 Balance wheel | 17 Drop Feed Knob |
| 2 Needle Plate | 12 Zigzag, Plain Stitch and Buttonhole sewing Control knob | 18 Bed Plate |
| 3 Needle Holder | 13 Needle Displacement lever | 19 Knee Control Lever |
| 4 Thread Tension | 14 Stitch - Length - Stop | 20 Free Arm |
| 5 Face Plate | 15 Stitch length lever with control knob for buttonhole | 58 Set screw for satin stitch stop |
| 6 Light Switch | 16 Bobbin Winder Shaft | 59 Satin stitch stop lever |
| 7 Take-up lever | 17 Drop Feed Knob | 60 Balance wheel release |
| 8 Thread Guide | | |

Electrical part

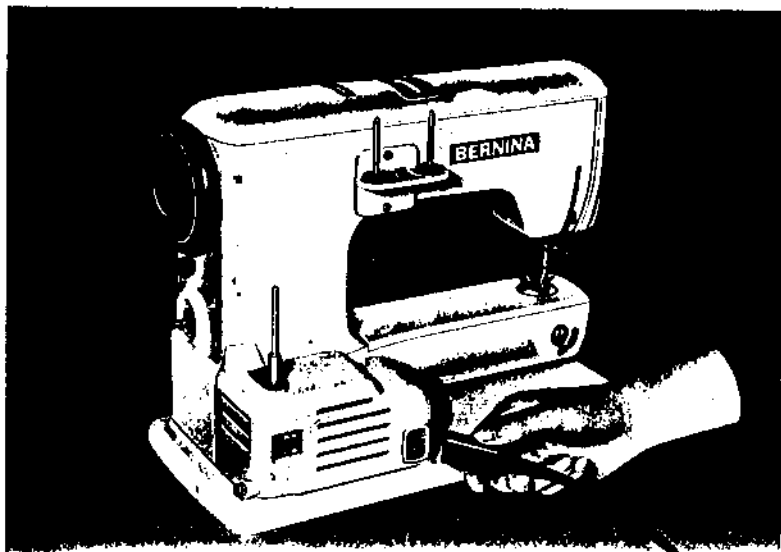

Fig. 4

The drive of the BERNINA-Record Model 530-2 and Model 532-2 is by the universal motor placed at the rear. Motor and rheostat control are concealed beneath the protective housing, which bears a plate specifying the voltage and power of the motor (Fig. 4). Prior to connecting the flex to the mains, make sure that the voltage indicated on the plate corresponds to the mains voltage. The mains voltage is indicated on the electric meter of your home. This must always be checked, particularly if the machine is to be used away from home. Do not rely on the voltage indicated on plugs and sockets.

After connecting the cord extension to the machine, start machine by exerting slight pressure on the knee control lever with your knee. The farther the lever is displaced to the right, the greater the speed of the machine. Practise speed control several times without threading the machine.

The lamp is arranged in the swivelled head cover so that it will evenly distribute light over the sewing area. It is switched on and off by pressing the light button. The bulb can be changed when necessary; turn it anticlockwise to remove, clockwise to insert.

Foot Control connect the lead from the foot control to the machine and then connect the main electric lead. Start machine by slight pressure of the foot on the foot control plate. The further the foot control plate is depressed the greater the speed of the machine.

Bobbin Case and Bobbin

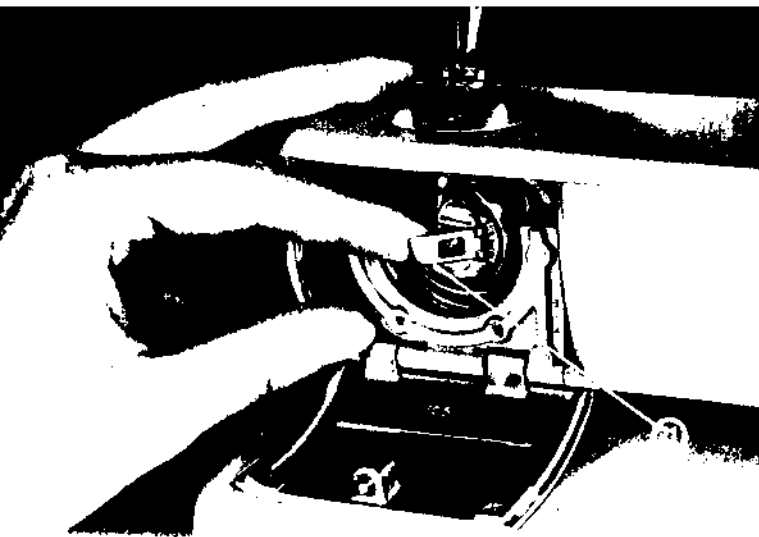

Removal of Bobbin Case

Place take-up lever 7 (Fig. 2) approximately in its extreme top position. With the index finger of the right hand open the hinged shuttle cover. Now open the hinged latch 21 (Fig. 5) with left index finger, removing the case complete with bobbin. By releasing latch, bobbin is free to drop out of the case.

Fig. 5

Winding the Bottom Thread

A neater stitch is obtained if the bottom thread is chosen somewhat finer than the upper thread. The reel from which the winding has to be done is placed onto one of the two reel-pins 22 (Fig. 6). In order that the whole machine may not run needlessly when

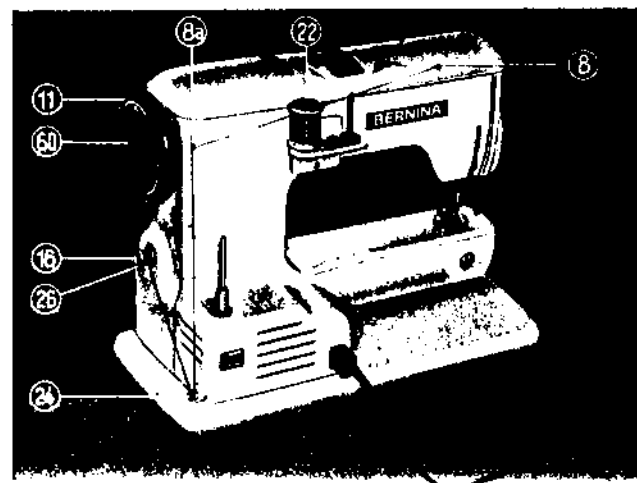

Fig. 6

winding, turn with your right hand the handwheel release screw 60 as far as possible towards you, at the same time holding the handwheel 11 firmly with your left hand.

Slip the bobbin 26 onto the bobbin shaft 16 projecting out from the stand below the handwheel, and turn it slowly until the small pin mounted on the bobbin shaft engages in the slot of the metal bobbin. This pin ensures that the bobbin turns with the shaft.

Bringing the thread to the bobbin is simple. From the thread reel placed on the pin 22, pass the thread first through the eye 8 located at the back, then through the eye 8 a, and from there downwards between the tension discs of the bobbin tensioning device 24 onto the bobbin 26.

The motor can then be started by a slight pressure on the knee lever or foot plate. Care must be taken never to fill the bobbin right to the rim. After finishing the winding operation, tighten the handwheel release screw 60 again.

Inserting the Bobbin in the Case and Threading the Bobbin Thread Replacing Bobbin Case in Shuttle

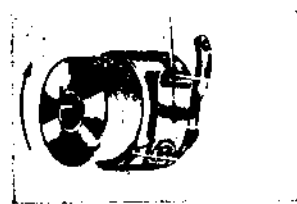

FIG. 7

When replacing bobbin in case, make sure that bobbin turns in the direction of the arrow when thread is pulled. After insertion of bobbin, pass thread through slot 27, below tension spring 28 and allow it to come out at the end of tension spring 29.

Insertion of the bobbin case is possible only when the needle is in its raised position. The case is held by the opened latch 21 as when removing it (Fig. 5).

The index finger and thumb of the left hand hold the hinged latch so that the bobbin case finger 30 (Fig. 7) points upward and engages the recess in the shuttle race cover. Then place the bobbin case on the shuttle pin as far as it will go. Now release latch and make sure that it is properly closed. If the hinged latch does not close completely, thread ends or fluff have collected at the base of the shuttle pin and must be removed.

Needle and Thread

Setting the Needle

Use only System 705 needles. Needles with blunted points or bent needles should not be used. Turn the balance wheel towards you until the needle bar is at its highest. Hold needle between thumb and index finger of the left hand so that the long groove *faces you*. The flattened end of the needle shank must therefore, be at the rear. Now loosen the needle holder screw by turning it in anticlockwise direction and insert needle as far as it will go. Then tighten needle holder screw by turning it in the opposite direction. It is important that the needle should be pushed right up to the needle stop and firmly clamped by the needle holder screw.

Needle and Thread Selection

System 705 needles are used exclusively on the BERNINA-Record Model 530 2 and Model 532-2. In order to obtain satisfactory results, use only first-quality needles and high-grade thread.

First select the thread suitable for the work; then the needle to accommodate the thread, using the table on the opposite page as guide.

The relation between needle and thread is correct if the thread, when placed in the long needle groove, fills the latter well and can be freely moved up and down.

For sewing, the usual needle sizes are 80, 90 and 100, for crosswise darning, use needle sizes 70 and 80.

Needle and Thread Table

System 705 Needle Size	Sewing Thread		Darning Thread
	six-ply (unglazed)	three-ply (unglazed)	two-ply
60	-	170-200	80-100
70	70-100	70-140	50-80
80	50-60	50-70	30-40
90	40-50	30-40	-
100	20-30	-	-

Thread suitable for Sewing and Darning

For plain sewing: Nos. 60-90, three- and six-ply, unglazed

For darning: Nos. 50-80, two-ply

For zigzag sewing: Nos. 60-90, three-ply only

For ornamental stitches: Nos. 30 and 40, two-ply

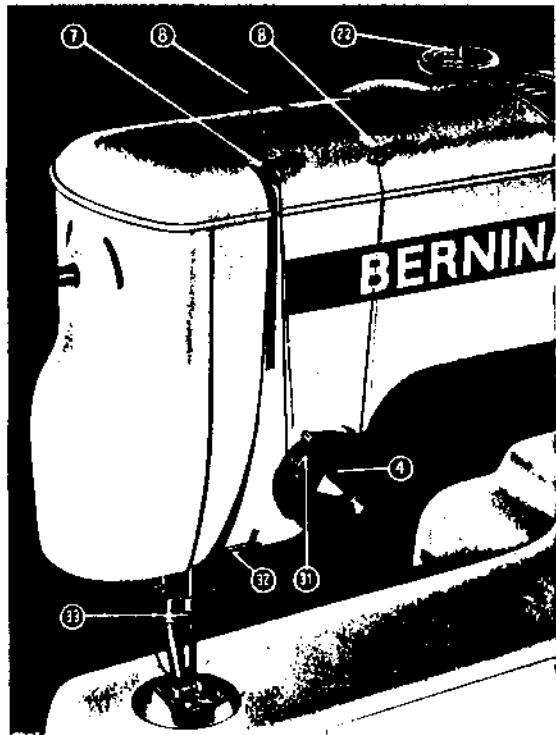

- 4 Thread tension
- 7 Take-up lever
- 8 Thread eyelet
- 22 Spool pin
- 31 Ring for thread tension disc
- 32 Thread guide pin
- 33 Needle thread guide

Fig. 8

Threading the Top Thread Fig. 8

The thread spool is placed on one of the two pins 22 placed at rear of top arm. From there pass thread through the rear eyelet 8, through front eyelet 8 down to the thread tension between the tension discs in the tension box 31, up to the take-up lever 7 and down again behind the thread guide pin 32 and through the needle thread guide 33 and finally through the needle eye from front to rear. Make sure that take-up lever 7 and needle are in the raised positions when threading the machine. Thread tension 4 is formed as a double tension. When only one thread is inserted, it is immaterial whether the thread is passed between the front or rear tension disc.

Bringing up the Bobbin Thread

The end of the top thread projecting from the needle eye is loosely held between thumb and index finger of the left hand, while the fly wheel is turned towards the operator by one revolution with the right hand, until the take-up lever is approximately in its extreme upper position. The upper thread end is now slightly pulled, which causes the bobbin thread to come up. Top and bottom threads are slightly tightened and placed rearwardly under the presser foot.

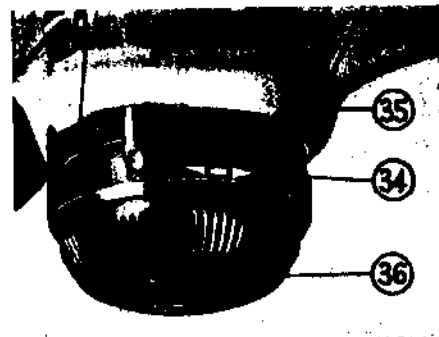

Fig. 9

Thread Tension Box Fig. 9

The thread tension is designed to operate without special adjustment for all normal sewing and mending work.

A sight hole is provided on the upper portion of the thread tension box, which is equipped with a reference line 34 on either side. Below this reference line is situated the white ring 35 on the adjusting nut 36, marking the normal adjustment of the thread tension. To set the tension turn adjusting nut 36 until the white line is level with the reference line 34.

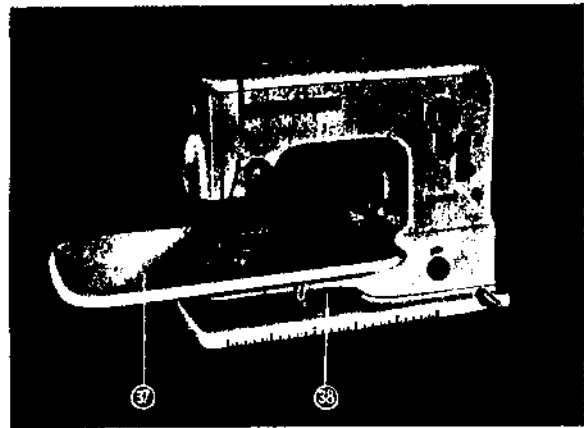

Fig. 10

Fixing the Slide-on Table Fig. 10

The slide-on table 37 is accommodated in the rear wall of the carrying case and held there by means of a bolt. Swivelling the bolt to the right releases the table.

When the table is slid onto the free arm, make sure that the locking lever 38 is pointing to the right. In order to clamp the table to the free arm rigidly, the lever is moved to the left.

Cleaning and Oiling

Cleaning the Machine Figs. 11 and 12

Fluff is collected during sewing particularly around the shuttle. Such fluff may detrimentally affect the proper function of any machine and it is absolutely necessary to remove it frequently. From time to time, remove cover plate 1 so that the fluff forming under the needle plate can be removed.

The cover plate is accordingly designed for quick removal, so that cleaning and oiling can be effected easily.

To remove the cover plate, open the hinged 39 plate and depress the releasing lever 40 (cf. Fig. 11) with the index finger of the right hand. The presser foot need not be removed but the needle should be placed in its raised position.

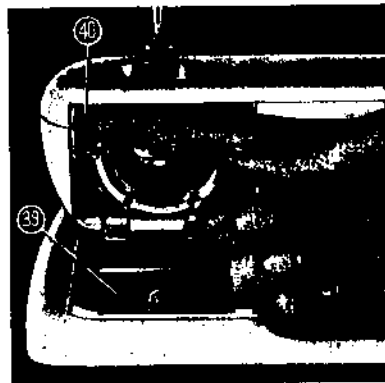

Fig. 11

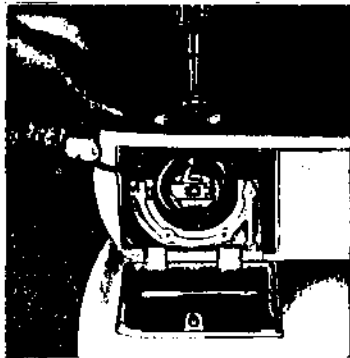

Fig. 12
To insert the cover plate, move it up to the standard and insert the plate tongue into the guide provided in the standard. Then depress the cover plate at its foremost point, and the latch will engage automatically (Fig. 12).

Oiling

The sewing machine should be oiled frequently, but not too liberally. A few drops of oil suffice to keep the machine running freely. Excess oil will drain off unused

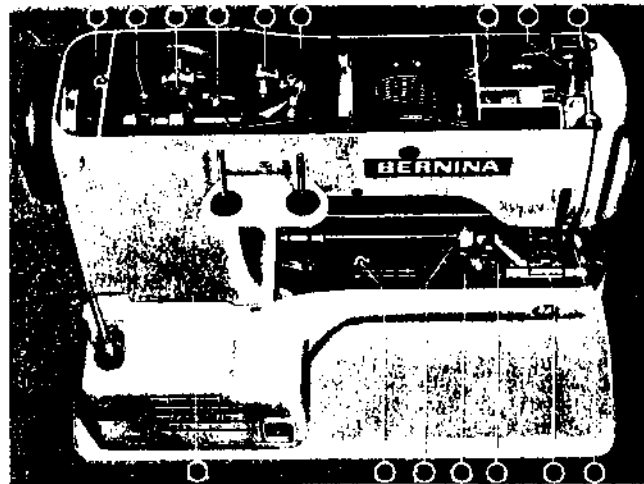

Fig. 13 a (el. 530 2)

and may soil the fabric. Always oil the machine *before* sewing, not afterwards. Use clear oil which is free from resin and acid such as is supplied by the Bernina dealers. Use of inferior oils may cause the machine to jam when the oil dries and becomes tacky. Figs. 13 a, 13 b and 14 show the oiling points indicated by white lines. Opening the hinged cover on the front of the free arm gives access to the shuttle of which the race should be oiled frequently but lightly at the point indicated by the arrow one fig. 14.

Adequate oiling ensures quiet operation of the machine and lengthens its life. The oiling points not visible in Figs. 13 a, 13 b and 14 are marked in red on the machine.

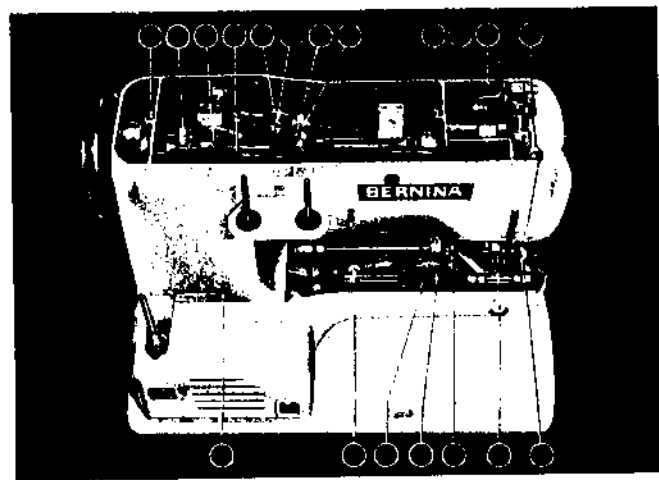

Fig. 13 b (el. 532 2)

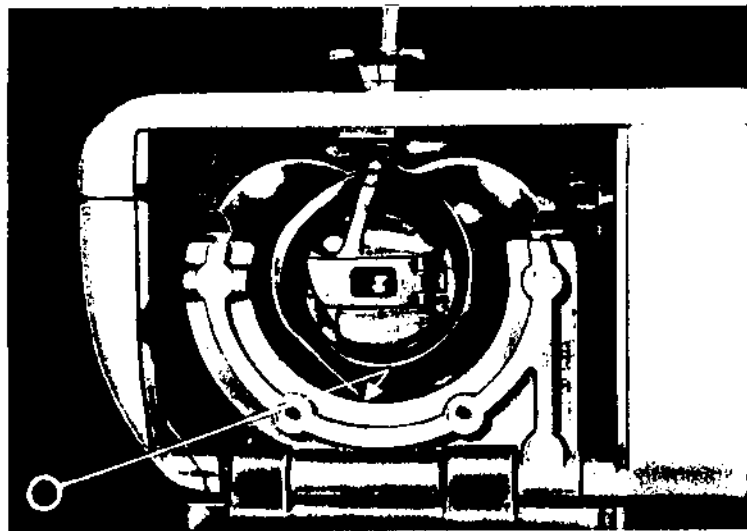

Fig. 14

When the machine has been kept in a very cold room, it should be opened and placed in a warm room about one hour before use so that it assumes room temperature and allows the oil in the bearings to become liquid again.

Important Oiling Instructions

1. Excessive oiling will cause trouble.
2. If the speed of a machine has substantially decreased, this is generally due to excessive oiling of the motor.
3. The motor of every new machine is oiled at the factory, and need not be oiled during the first year.
4. After the first year, the motor requires oiling only *every six months if the machine is in daily use, a maximum of 4-5 drops being placed into the two oiling points marked in red.* If the machine is used *once a week, one annual oiling* in the second and subsequent years is sufficient.
5. If the motor is oiled too little, this condition is shown by abnormal noise.
6. To oil the motor, remove the motor housing. The two diagonally opposite nickel-plated screws below the bed plate are removed and 4-5 drops light, odorless sewing machine oil are applied to the points marked in red on the two bearings.
7. Always make sure that all other portions of the motor are kept free from oil.
8. These instructions apply to the motor only.

Plain Stitch

Plain Stitching with Standard and Special Presser Foot

Exchanging Presser Foot

Different sewing work requires more or less frequent exchange of the presser foot. This is why the BERNINA Record Model 530-2/532-2 has been equipped with a presser foot holding device which does not require the aid of a screwdriver but still ensures positive clamping of the presser foot.

a) Removal of Presser Foot Fig. 15

The cloth presser bar with presser foot is lifted by the lifting lever placed on the rear of the head. Now raise clamping lever 41, which engages below the clamping boss 42 of the presser foot 43, far enough for the hook 44 of the clamping lever to release the clamping boss 42 completely. The presser foot will drop automatically, or with a little help from the cloth presser bar cone and can easily be removed.

b) When replacing the Presser Foot proceed in the opposite order: After raising the cloth presser bar by means of the lifting lever, hold the shank of the presser foot between thumb and index finger of your left hand, and place the presser foot below the cone of the cloth presser bar while the needle is raised. Now lift the clamping lever 41 with your left hand and slide the presser foot into the cloth presser bar cone making sure that the screw 45 engages the guide of the presser foot. Then depress clamping lever so that it will engage below the clamping boss of the presser foot. Slight pressure exerted on the lever will suffice to secure the presser foot firmly on the cloth presser bar cone.

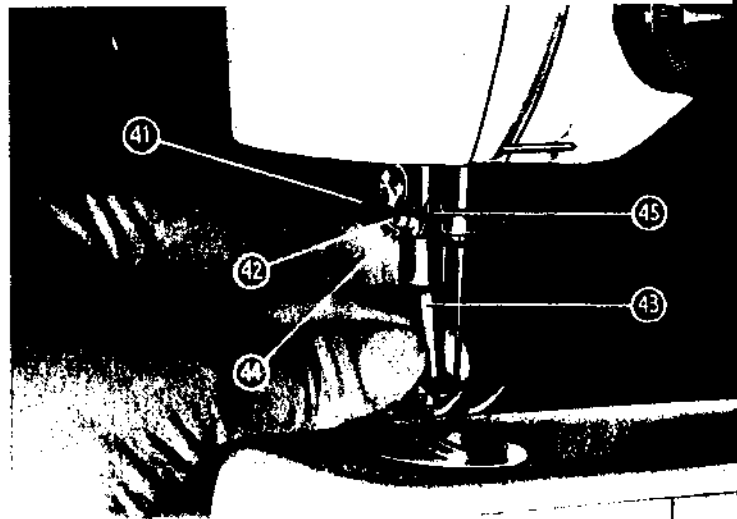

Fig. 15

Lowering the Feed Dog Fig. 16

At the right-hand bottom portion of the machine is placed a control knob 17 designed to lower or raise the feed dog. According to whether the knob is moved to the left or

the right, the symbol showing that the feed dog is in operative position, i. e. that the machine is ready for sewing, or the symbol showing that the feed dog is lowered and the machine set for darning will appear in the window 46.

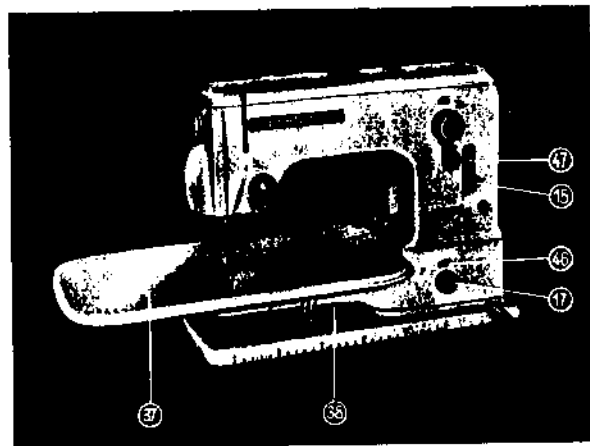

Fig. 16

Plain Stitch

For plain stitching, adjust the machine as follows:

1. Raise take-up lever approximately to its highest point.
2. Insert plain stitch presser foot (for ordinary plain stitch work, the zigzag presser foot may be used as well). Thread needle from front to back. Pass top and bottom threads together back under the presser foot.
3. Turn control knob to the left to bring sewing symbol into sight.
4. Adjust stitch regulator so that the zero mark of the stitch length dial is above the line mark on the right-hand side. This is possible only if the screw 14 (Fig. 2) is not quite screwed in.
5. Set zigzag knob to zero. In this position, the machine will do plain sewing. As soon as the knob is turned to the right, a zigzag stitch will result.
6. Slide on sewing table.

Make sure that the balance wheel is always turned in the direction of the arrow, i. e. towards the operator.

Forward and Backward Sewing and Adjustment of Stitch lengths

According to the position of the stitch regulator 15 the machine will sew forward or backward, making long or short stitches. If the stitch regulator lever 15 is depressed so that the zero line of the stitch length dial 47 is above the line mark on the side, the

machine will sew forward. When the regulator lever is raised so that the zero line is below the line mark, the machine will sew backward. Forward and backward sewing serves to strengthen certain sewing areas and to secure the ends of the threads.

The more the stitch regulator lever is displaced upward or downward, the longer the forward or backward stitch will become. In order to ensure that the forward and backward stitches are of the same length, the lock screw 14 limiting the upward and downward movement of the stitch regulator lever 15 is turned outward or inward to a greater or lesser degree. If the screw is turned outward, the displacement of the lever is increased, and inward rotation of the screw will reduce the displacement.

Removal of Work from the Machine

Raise the take-up lever into its highest position and lift the presser foot by means of the lifting lever. This releases the top thread tension, so that the work can easily be removed.

In particular, make sure that the work is always pulled from under the presser foot towards the rear to prevent the needle from becoming bent and causing thread breakage and faulty stitches.

Fig. 17 a b c

Darning and Mending

When the machine is set for darning (plain and crosswise), proceed as follows :

1. Raise take-up lever.
2. Remove presser foot and replace by hopper foot.
3. Lower feed dog by turning knob to the right to produce the darning symbol.
4. Set stitch regulator to zero so that the feed dog is not unnecessarily operated.
5. Set zigzag knob to zero.

The BERNINA-Record Model 530-2 and Model 532-2 can be used for darning with or without the slide-on table depending on the type of the work.

Cross-wise Darning for Linen, etc.

Cross-wise darning is simple with the Bernina, thanks to the patented hopper darning foot.

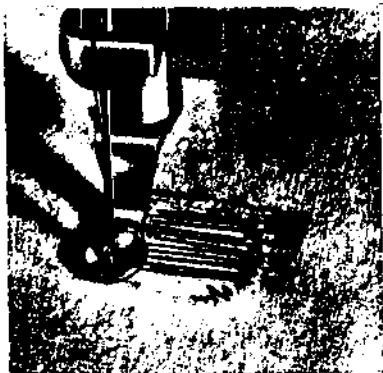
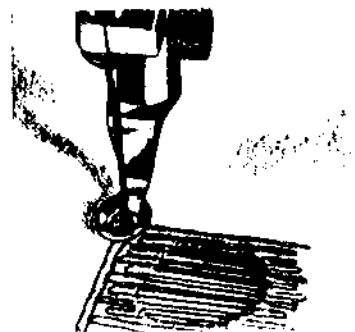

Fig. 17

a
b



Start by sewing stitch rows from left to right and vice-versa (Fig. 17a). These rows should be parallel and as close to one another as possible. Do not extend the rows beyond the edge of the damaged area farther than absolutely necessary to secure the stitches. It is advantageous to make rows of different lengths in order to prevent the material from tearing at the edge of the area darned.

Then cover the parallel rows with new parallel rows at right angles running front to back and vice-versa.



The first covering rows are sewn a little beyond the outermost first rows (Fig. 17b) in order to obtain a regular and strong darned area. The covering rows should also be parallel and as close to one another as possible.

Finally fill the small gaps in the darned area by a number of additional covering rows limited to the exact area originally damaged (Fig. 17c).

Darning Stockings

Darning stockings is rendered easy and convenient by the Bernina Darning Attachment. Its operation is very simple.

Fig. 18

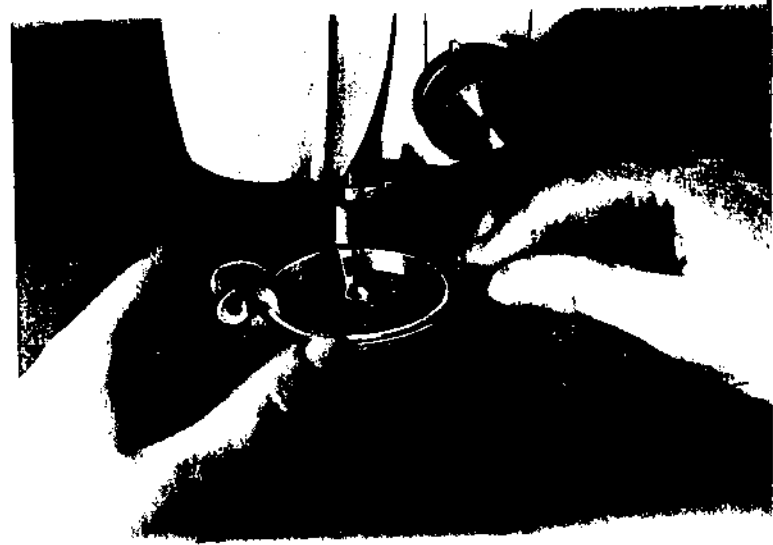

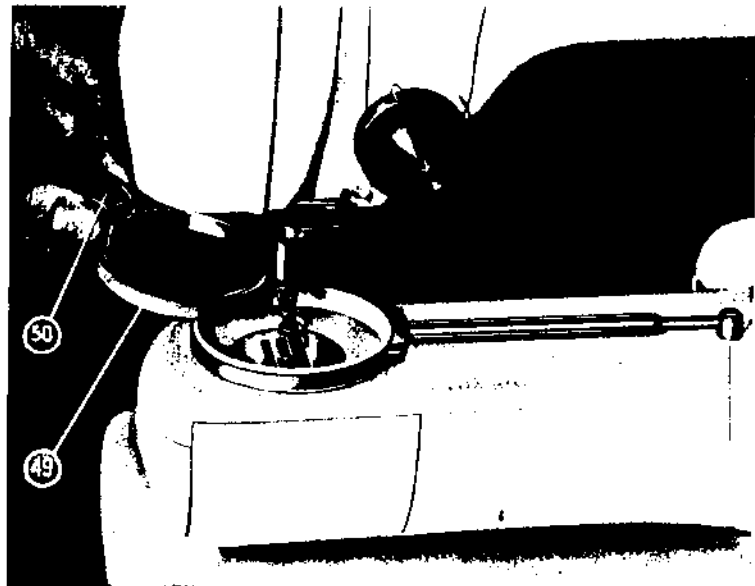

Fig. 19

Place the complete attachment on the free arm and set the small stud at the shank end into the hole in the arm cover 48. Then lift the inner ring 49 of the darning attachment off the outer ring by pressing the two finger tongues 50 together. Now pull the stocking over the free arm and the darning attachment until the damaged area is centred in the darning ring. It is advantageous to slide the darning ring as far to the left as possible, in particular if the damaged area is at the top or heel. Then clamp the inner ring into the outer ring now covered by the stocking (Fig. 19), and make sure that the stocking area is uniformly tightened. Press inner ring as far as it will go so that the damaged area rests on the throat plate. The damaged area now centered in the ring can easily be moved in any direction.

When beginning, it is usual to sew a full circle around the damaged area to prevent running. Then sew a line of stitches across the direction of the fabric stitches. The lines should be of different lengths and as close to one another as possible. This is done by sliding the darning ring forward and backward. As soon as the hole is completely sewn over, cover these lines in the direction of the knit stitches by moving the darning ring from left to right and vice-versa. The inner ring may also be turned by one-quarter turn and the darning ring then again moved forward and backward. Start these covering lines somewhat beyond the outermost stitch lines (cf. Fig. 17 b). The covering lines, which should be of different lengths, should be disposed side by side in line with the fabric stitches. Now fill the small spaces in the mended area until the hole is uniformly covered.

Lap Hemmer

Tailored effect obtained by having both rows of stitching on the R.S. Can be used to make Run and Fell seam; useful for nightwear, underwear and children's garments.



a

Fig. 20

b

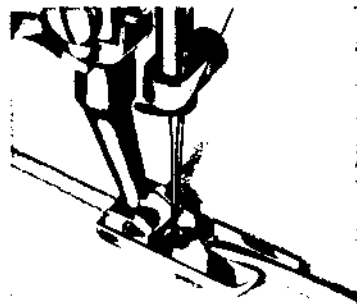

Lap hems are used to produce very firm seams. They are obtained in two operations, viz.:

1st Operation (Fig. 20 a): Arrange the fabric sections to be joined on top of each other in such a manner that the bottom section slightly projects from the top one and pass with sections touching both under the lap hemmer as when hemming so that they are folded over. Make sure that the same width of material always enters the lap hemmer.

2nd Operation (Fig. 20 b): The two sections are now unfolded and laid flat so that the seam formed stands up like a pleat. This pleat is again passed into the lap hemmer in the same direction so that it is folded over and sewn down.

Hemmer

(Hem width approx. $\frac{1}{2}$ ")

Attach the hemmer in place of the ordinary presser foot, raising the presser foot bar for the purpose.

Fig. 21



Fold the edge of the material over to the desired hem width and pass the fabric into the spiral-type guide tongue of the raised hemmer as far as the needle, then lower the hemmer.

When sewing, lightly guide the prefolded edge (Fig. 21). If too much fabric enters the hemmer, the seam will become bulgy and uneven; if too little the hem will not be folded in sufficiently.

(Available as Extras)

Gathering foot

Fig. 21a

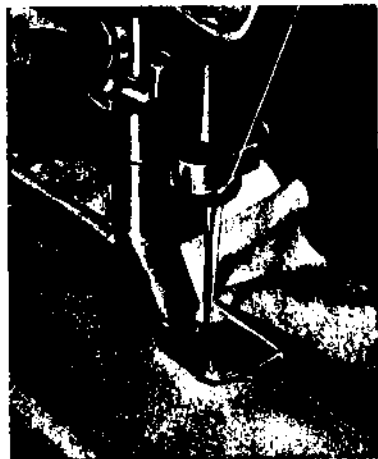

Put the material to be gathered under the gathering foot, that is to say not in the transverse slot. Lower the gathering foot by means of the presser foot lever and insert the piece of material, which must remain quite flat, in the transverse slot as far as it will go. To increase the amount of gathering or gauging on the bottom material hold the top material back - the more it is held back the greater the amount of gathering.

If only one layer of material has to be gathered place the material beneath the gathering foot and lower it. The material is gathered more or less as the length of stitch is made greater or smaller.

Edger

As shown by the illustration, the stitch hole is placed adjacent to the right presser foot edge. The foot, without the lateral quitter guide attached, is particularly suitable for edgestitching, facings, collars etc. and inserting zips.

When the adjustable edge guide is attached to the edger, the latter can be used for quilting work as shown in Fig. 22 below.

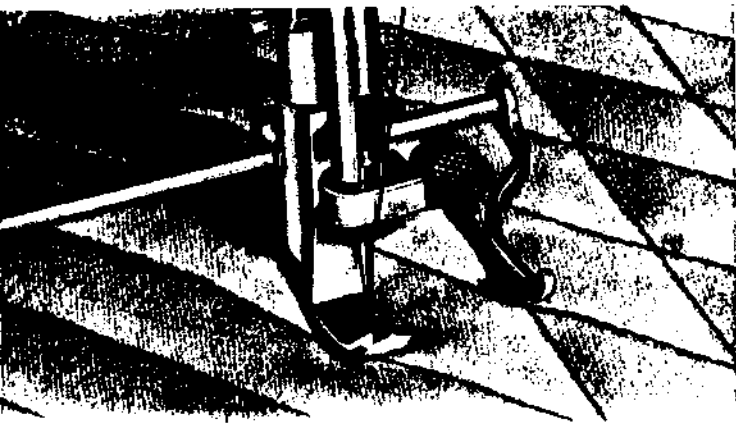

The guide is first fixed at the desired distance from the edger. Then make a seam and shift the material to the right so that the seam just made is in line with the guide. Then sew a new seam following the direction of the first seam with the leg of the guide, and so on. Afterwards, the same operations are effected in the transverse direction.

Fig. 22

Zigzag

Zigzag Sewing

Adjustment of Stitch Width

At the right-hand top of the body of the machine is placed the Control Knob 12 (Fig. 2) which serves to adjust the stitch width. Above the knob is a sight hole in which the width of the seam is indicated in figures. For plain sewing, the knob is turned to show the numeral 0, i. e. that a straight stitch can be produced. When turning the knob to the right, the numerals 1-4 will appear. The higher the numeral, the wider the zigzag stitch will be. When sewing zigzag, this knob may be operated as desired. When the machine is not running, do not turn the knob unless the needle is raised from the material in its extreme position.

Left-centre-right Adjustment

On top of the width control knob is arranged a further lever 13 (Fig. 2) marked with an arrow. If the arrow points straight up, the needle will be deflected evenly to the left and the right (Fig. 23 a). Rotation to the right to point the arrow obliquely to the

right will cause the needle to be deflected from the right to the left (Fig. 23 b). Rotation to point the arrow obliquely to the left will cause the needle to be deflected from the left to the right (Fig. 23 c).

This control, too, can be turned to centre, left or right during operation, but it should again not be rotated when the machine is not running unless the needle is in its raised position above the material.

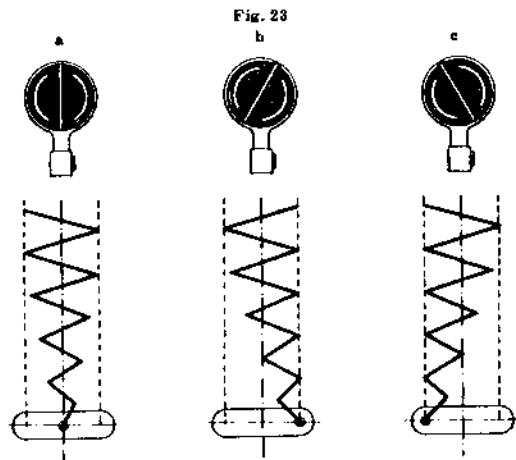

Fig. 23

a) Needle deflection evenly from centre to right and left

b) Needle deflection from left to left only

c) Needle deflection from right to right only

The majority of zigzag work is performed with centre stitch, while left-hand stitch is employed for button-holes, sewing on buttons, ornamental stitches.

The right-hand stitch is employed for other ornamental stitches, and a combination of the left and right hand stitches is very often used as well.

Zigzag Sewing

(Use 2- or 3-ply threads, never 6-ply)

For zigzag sewing, set the machine as follows:

1. Raise take-up lever 7 (Fig. 2) to approximately its extreme position.
2. Insert zigzag foot, which should not be confused with the *zigzag embroidering foot* (Fig. 47). Its lower surface is hollow ground. Pull top and bottom threads backwards under zigzag foot.
3. Adjust drop feed knob 17 to sewing mark by turning in anti-clockwise direction.
4. Set the stitch length regulator between 0 and 4 on the stitch length scale. This is possible only if the screw 14 is not turned in completely.
5. Turn zigzag control knob 12 to the right according to the desired width (0-4). The more it is turned to the right, the wider will the zigzag seam be. The zigzag knob should never be operated when the needle is in the material while the machine is idle. But the zigzag knob can be operated in either direction when the machine is running.
6. Slide on sewing table.

Elastic Sewing of Knitted Goods

Knitted goods can be mended in a variety of ways of which the two most usual are described below:

Fig. 24 a

Alternative 1: The mending patch is cut to the desired shape and size and then placed on top of the damaged part of the fabric in line with the direction of the loops. The under side of both sections must face up. The pieces are fixed by provisional stitches. Then sew over the cut edge of the patch with zigzag stitches (stitch length 1 and width 3 or 4). A second zigzag seam is sewn inside this seam, at a distance of approx. $\frac{1}{4}$ " and the damaged area then cut out along the inner seam and the provisional stitches removed.

Alternative 2: The mending patch is placed under the damaged portion with the loops in line (Fig. 24 a), the under side of both sections facing up, and the patch sewn on (Fig. 24 b).



b
c

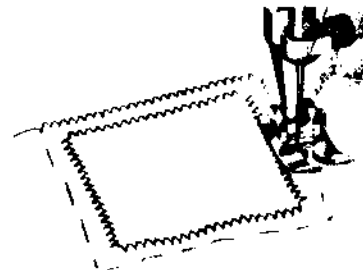

Now sew a zigzag seam along the basting stitches (Fig. 24 c) using stitch length 1 and width 3 or 4, and a second seam at a distance of approx. $\frac{1}{4}$ ". Then cut the damaged area out along the inner stitches and trim the free edge of the patch below along the outer seam. Finally remove basting.

Sewing on Lace

To sew on lace use short stitch lengths and narrow stitch width as a rule. Normally the stitch length regulator 15 (Fig. 2) is set at 1 and the zigzag knob 12 at 1-2. Place lace on the material, so as to overlap by about 1", thus facilitating sewing on. Now attach the lace by zigzag stitches and then cut off the free edge of the material along the zigzag seam.

Roll Hemmer

The roll hemmer, characterized by two red lines on its shank, is similar in shape to the ordinary hemmer but is provided with an elongated stitch hole so that zigzag seams can be sewn. The roll hemmer is operated in the same manner as the ordinary hemmer. The zigzag control knob 12 (Fig. 2) is set at approx. 3-4. Roll hems are used particularly for edging fine material.



Fig. 25

Shell Roll Hem

For shell roll hems, use the roll hemmer (2 red lines). The material with knitted fabric is inserted in the spiral guide tongue as for roll hemming. The zigzag stitch bridges the entire seam. Tight top thread tension and large stitch length produce the shell-type effect. This shell roll hem is used mainly for edging knitted goods.

Braiding

Insert a soft cord in the guide hole of the zigzag embroidering foot, which is marked by one red line on its shank, and stitch or embroider over with zigzag stitches. Use mercerized thread 50/2 or 60/2. A variety of effects can be obtained with this type of stitch. Colour thread, coloured cord, a number of adjacent seams etc. will enhance the effect.

Fig. 26

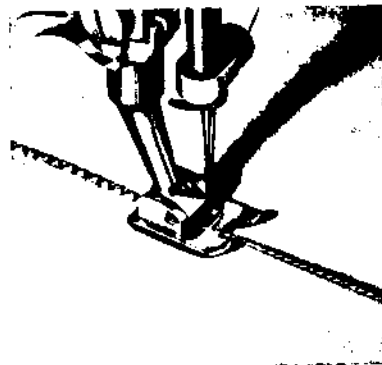

b

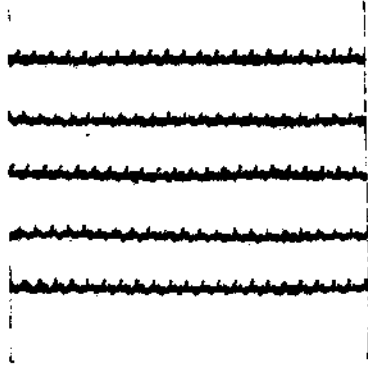

THREAD CUTTER

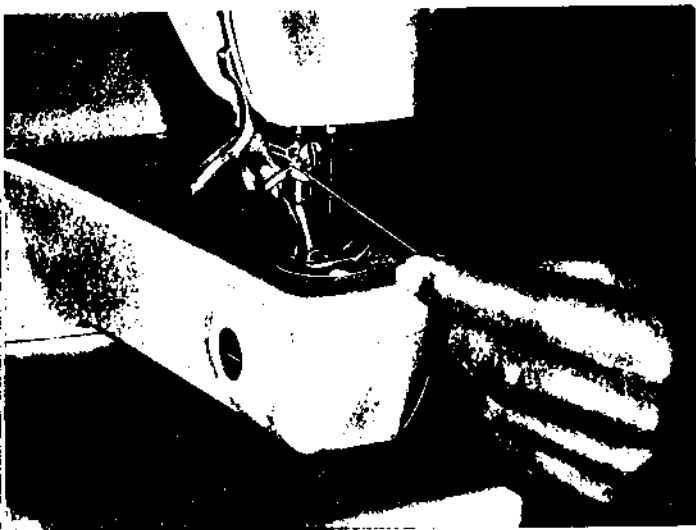

The presser foot clamping lever on the BER-NINA sewing machine at a convenient spot is provided with a sharp edge to be used as thread cutter. (See illustration.)

This device helps save time especially when scissors are not in reach of hands.

Fig. 26 c

Fig. 27

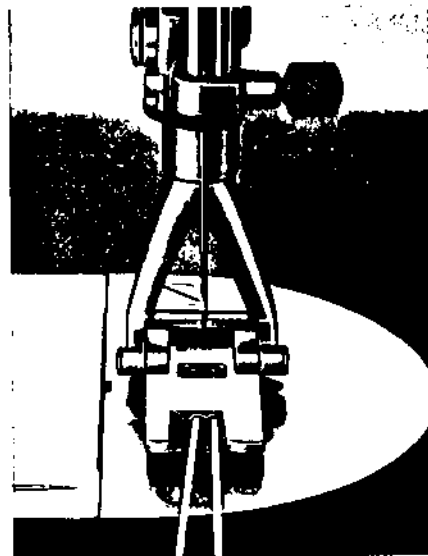

Buttonhole Sewing

automatic

There are three kinds of buttonholes:

- A) the ordinary buttonhole
- B) the buttonhole with cord inlay
- C) the raised buttonhole

A. The ordinary buttonhole

This is sewn with normal lower thread tension, but with special threading of the bobbin case (see Fig. 27). The sewing of the buttonhole with the new buttonhole device is effected *without* turning the cloth round. The buttonhole can be sewn either *step by step*, the machine being stopped after each operation, or in *one working operation*, i. e. without interrupting the various working stages. It will be well to *learn sewing buttonholes step by step*. After a little time you will naturally sew the whole buttonhole in one working operation.

The threading of the bottom thread when sewing buttonholes automatically

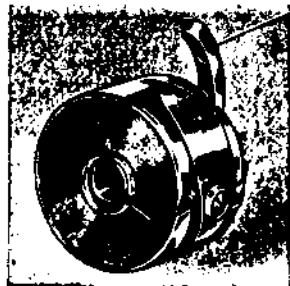

Kl. 530-2

Fig. 27 a

An increased tension of the bottom thread produces best results when sewing buttonholes automatically. To get this higher bottom thread tension without changing the lower tension itself, which is correct for normal sewing, a hole was drilled through the finger of the bobbin case through which the bottom thread has to be threaded (see adjoining illustration).

Through this measure the bottom thread tension is slightly increased and the hook will take less thread from the bobbin which is correct for good buttonhole sewing.

For normal sewing the bobbin case is threaded as explained in the instruction booklet on page 17.



-  Lever (for actuating the locking catch)
-  Stitch-length lever

Fig. 28



For sewing buttonholes, the machine is adjusted as follows:

1. Insert buttonhole presser foot.
2. Feed-change knob 17 (Fig. 2, page 6) must stand at "sewing".
3. Push lever a (Fig. 28 and 29) to the back in the direction of the arrow, in order that it comes into the position shown in Fig. 30.

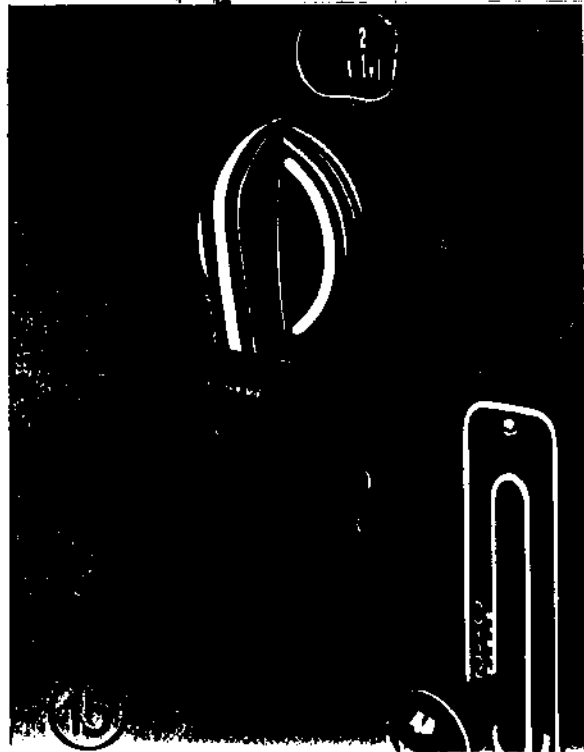
In this way the locking catch c (Fig. 30), which determines the width of stitch for the head and for the lock, comes into its working position.

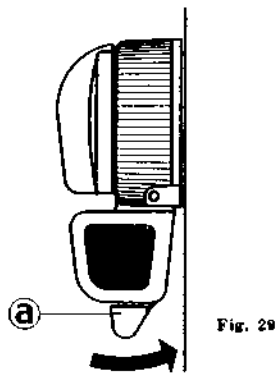

Fig. 29

Lever set for zig-zag sewing

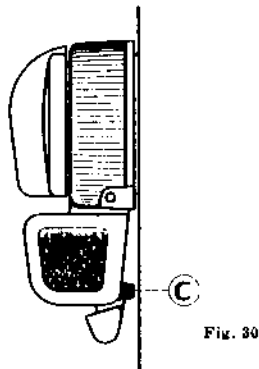

Fig. 30

Lever set for buttonhole sewing

4. The stitch length lever 15 (Fig. 28) has two marks on its ball-shaped end, the zig-zag mark Fig. 31 and the buttonhole mark Fig. 32.



Fig. 31

Buttonhole device disengaged
(zig-zag mark)



Fig. 32

Buttonhole device engaged
(buttonhole mark)



Fig. 33

With thumb and forefinger, the stitch length lever 15 (Fig. 33) is pressed as far as possible towards the machine in the direction of the arrow.



Fig. 34

Then turn the ball-shaped end clockwise until the buttonhole mark appears at the top.

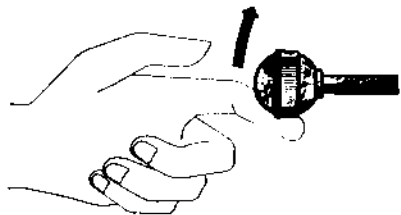

Fig. 35

Now let the end go loose and push it in the direction of the backward stitch (direction of the arrow) as far as possible upwards (Fig. 35).

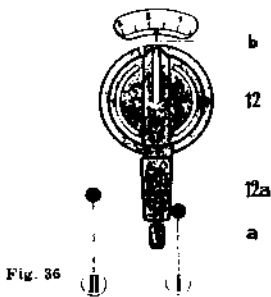

Fig. 36

5. After the stop c (Fig. 30) has been brought into the working position by moving the lever a, take hold of the lower part 12a of the knob 12, draw it to the front end, swiveling it in such a way that the pawl c comes to lie against the stop pin I. On the scale the number 1.5 must stand approximately opposite the mark b.

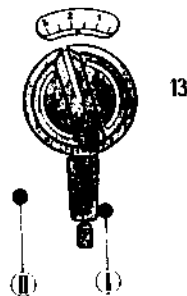

Fig. 37

6. Setting the lever 13 (Fig. 37). This lever is turned so far to the left until the *white mark* at its upper end lies opposite the white mark of the zig-zag lever 12 (Fig. 37). In this way the machine is set for buttonhole sewing.

The step by step sewing of the buttonhole is now effected as follows:

1. Sewing the lefthand bead.

Start the machine, then the *lefthand bead* is sewn in *backward stitch*. A scale on the buttonhole presser foot serves for determining the length of the buttonhole. After the desired length of bead has been reached, stop the machine. Always take care that the needle is then up.

2. Sewing the first end stitches.

For this purpose take hold of the zig-zag lever 12a, give it a strong push to the left until it comes against stop II (Fig. 38). Then sew a few end stitches after that, stop the machine again and set the needle up.

3. Sewing the righthand bead.

Bring the zig-zag lever 12a back from the *lefthand stop II* to the *righthand stop I* (Fig. 39). Start the machine again. Stop it again a few stitches before the righthand bead has become as long as the lefthand bead and set the needle up.

4. Sewing the second end stitches.

Again set the zig-zag lever 12a to the stop II (Fig. 40). After a few stitches have been sewn, stop the machine once again, and set the needle up as before.

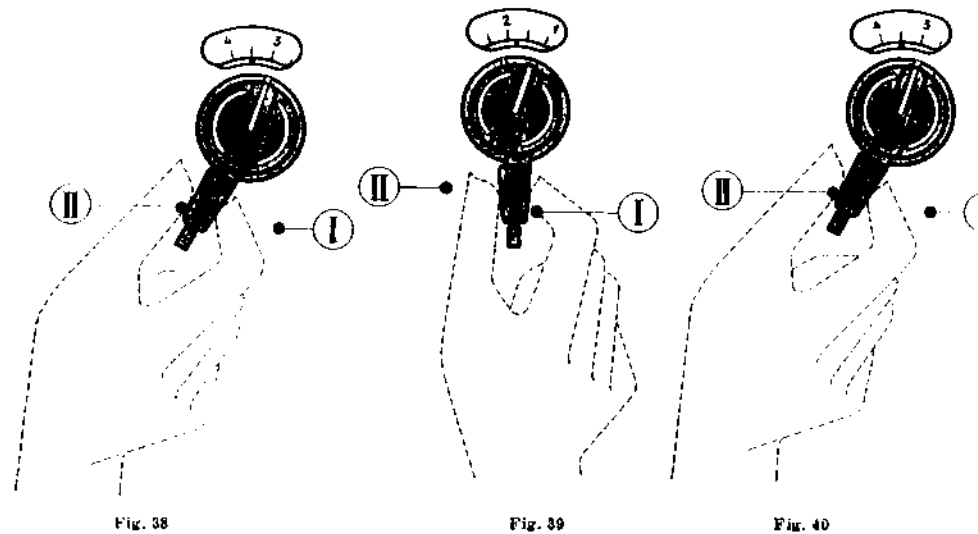

Fig. 38

Fig. 39

Fig. 40

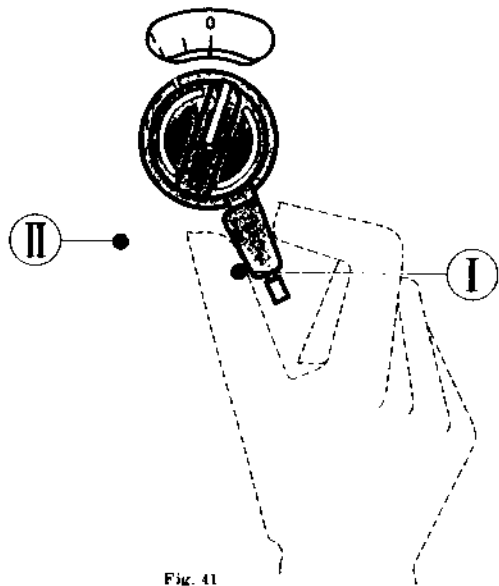

Fig. 41

5. **Stitching the fastening threads.**

For stitching the fastening threads, pull the zig-zag lever 12a - which is still against the stop II (Fig. 40) - towards the front and push it entirely to the right, passing over the stop I (Fig. 41). In this position the machine now sews the straight stitch. When stitching the fastening threads, it will be well to hold the cloth slightly back.

6. **Cutting the buttonhole.**

Lay the sewn buttonhole on the wood block and cut it through with the buttonhole cutter (Fig. 42).



Fig. 42

For the next buttonhole the zig-zag lever 12a and the lever 13/15 have to be adjusted as follows:

1. Set zig-zag lever 12a again against the stop I.
2. Turn lever 13 to the left until the *white* lines of the levers 13 and 12 are opposite each other.
3. Push the stitch length lever 15 upwards as far as it will go. Now the machine is again adjusted for buttonhole sewing and the handling of the zig-zag lever 12a is again effected as stated under "the step by step sewing of the buttonhole".

Sewing the buttonhole in one operation

In contrast to the described method, the buttonhole can easily be sewn in one operation, i. e. without stopping the machine after the different working steps. The buttonhole is sewn in one operation as follows:

After having set the machine for buttonhole sewing and having pressed the zig-zag lever 12a against the stop I (Fig. 39), start the machine and keep on holding the zig-zag lever 12a. As soon as the desired length of bead is reached, move the zig-zag lever 12a with a firm movement against the stop II (Fig. 38), and because only a few stitches are necessary for stitching the fastening ends, move the zig-zag lever 12a corresponding to the sewing speed (Fig. 39) at once again to stop I, and press it against this stop.

As soon as the second, righthand bead has reached the length of the first lefthand one except for a few stitches, move the zig-zag lever once again to stop II, and since also only a few stitches are required for the second fastening, move the zig-zag lever immediately quite to the right in accordance with the sewing speed, i. e. beyond stop I, by drawing the zig-zag lever 12a towards you, i. e. to the front.

B. Buttonhole with cord inlay

As inlay, use thin cotton cord and put it, as shown in Fig. 43, on the nose at the back end of the buttonhole foot and sew the buttonhole in the described manner.

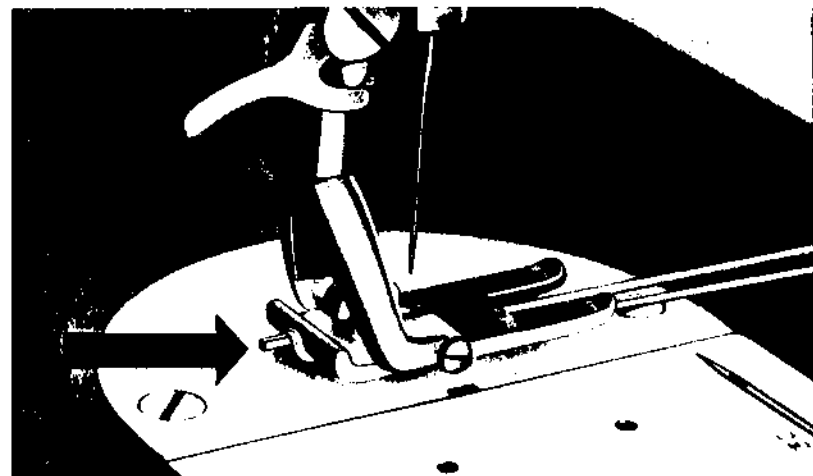

Fig. 43

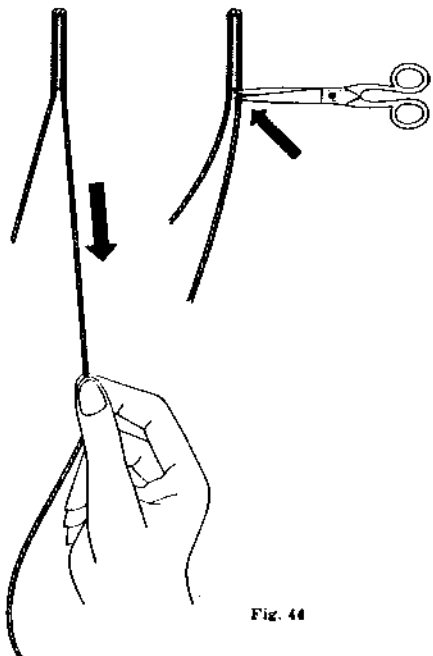

Fig. 44

The cord loop projecting beyond the back end of the sewn buttonhole, is tightened in such a way that the loop under the back fastening disappears. Then the two thread ends are cut (Fig. 44).

C. The raised buttonhole

This buttonhole is sewn with a slack lower thread tension and a strong upper thread tension. The upper thread tension has to be so strong that the bottom thread appears in a straight line on the upper side of the cloth. For raised buttonholes, the top thread must be unglazed, 6-ply, No. 4 thread, while a very thin thread is required for the bobbin (60/2).

Adjusting the machine from automatic buttonhole sewing to zig-zag or straight-stitch sewing

Push lever a (Fig. 28) forwards into the position in Fig. 29. The zig-zag lever 12a can now be moved as desired beyond the stops I and II from 0 to 4. Move lever 13 into the vertical position. Again press the stitch length lever 15 towards the machine, the ball-shaped end turned to the left until the zig-zag mark (Fig. 31) until the zig-zag mark shows on top.

Buttonhole without using the automatic

Buttonholes may also be sewn without using the automatic buttonhole device. In such case check that

1. the lever 12a (for actuating the locking catch) is in position for zigzag sewing;
2. the stitch length lever, i. e. its ball-shaped end, shows the zigzag mark (Fig. 31);
3. the needle displacement lever is set to its normal "left" position, i. e. not in position opposite the mark on the zigzag knob, as is correct for automatic buttonhole sewing;

4. the buttonhole foot, marked with 3 black lines, is used.

In this case also 3 different types of uttonholes can be made:

- a) Ordinary buttonholes,
- b) Braided buttonholes, and
- c) Raised buttonholes.

Types a) and b) are obtained with normal thread tension.

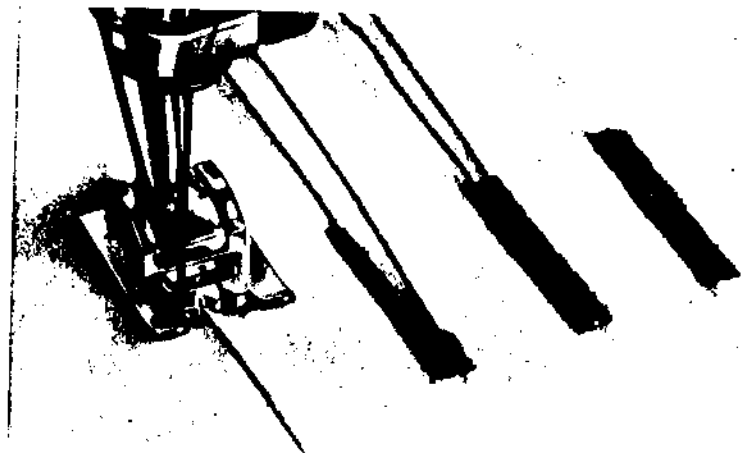

Fig. 45

The actual sewing of the buttonhole without using the automatic

1. Set zigzag control knob 12 (Fig. 2) to No. 2; when sewing a buttonhole in knit material, select stitch width $2\frac{1}{2}$.
2. Set stitch-length lever 15 so that the white line on the left side of the shaft of said lever is somewhat below the zero mark on the stitch length scale plate. This can only be done if the the screw 14 (Fig. 2) is not fully turned in.
3. Set drop feed knob 17 (Fig. 2) to the right.
4. Now sew the first bead to the length of the buttonhole. The last needle hole of the finished bead must be *on the right*, and the needle inserted only $\frac{1}{16}$ " into the material.
5. Raise presser foot and turn cloth through 180° in clockwise direction. Then lower presser foot and allow the needle to enter cloth towards the left. Allow needle to penetrate cloth only to depth of $\frac{1}{8}$ ".
6. Set zigzag control knob 12 to 3,5 and sew a few end stitches. Pull material lightly towards, you to shorten the feed. Last needle hole should be on the left. Allow needle to penetrate cloth only to depth of approx. $\frac{1}{8}$ ".



Last
stitch
on right

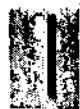

Allow
needle
to enter
on left



Last
stitch
on left

7. Set zigzag knob 12 again to No. 2 and sew the second bead over a length somewhat shorter than the first bead. Last needle hole on the left.

8. Set zigzag knob 12 again at twice the bead width and sew the end stitches. Again pull material back somewhat to shorten the feed. Last needle hole on the left.

9. Set zigzag knob at zero and sew a few fastening stitches again pulling the cloth lightly towards you to shorten the feed.

10. Finally cut the buttonhole as when sewn automatically (see paragraph 6, page 61).



Last
stitch
on left



Last
stitch
on left

Sewing on Buttons

1. Position needle to stitch on left.
2. Lower feed dog by turning knob 17 (Fig. 2) to the right until darning symbol appears.

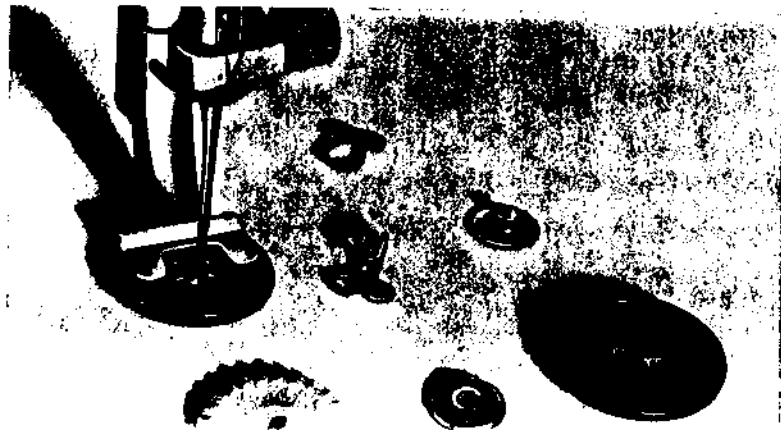

Fig. 46

3. Attach button presser foot marked by 2 black lines on its shank and place button under foot according to Fig. 46.
4. Adjust zigzag stitch width according to the distance between the stitch holes in the button and sew button on with 6-8 stitches.
5. To fasten the stitches, leave needle in the hole of the button. Lift the presser foot, turn zigzag knob 12 (Fig. 2) to zero, lower foot and fasten with several stitches.

With four-hole buttons, shift the cloth with the button and make 6-8 stitches in the second pair of holes. Press-studs and hooks are sewn on in like manner.

Darning with wool

When darning with wool, use the patented wool-darning foot. Proceed as follows:

1. Lower feed dog by turning knob 17 (Fig. 2) to the right until darning symbol appears.

2. Set stitch regulator 15 (Fig. 2) to zero to prevent lowered feed dog from being operated unnecessarily.

3. Set zigzag knob 12 (Fig. 2) to 3-4.

For top and bottom thread, use darning cotton. Wool is employed to cover the damaged area. Use top and bottom threads and darning wool of a colour corresponding to the piece to be mended so that the darn will be as invisible as possible.

Thread tension is the same as in ordinary darning.

Woollen socks are pulled over the free arm; the darning ring for stockings is not employed.

Darning with wool is performed in two stages:

1. The damaged area is covered with wool rows.
2. The rows are sewn down.

Fig. 47



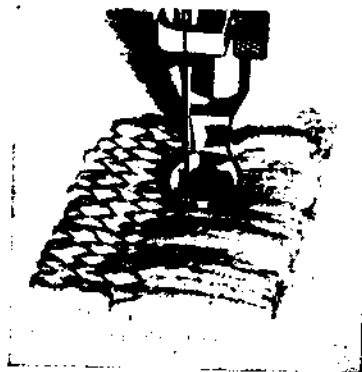

c

Figs. 47 a, b and c clearly illustrate the operation. As shown by Fig. 47 a, the wool is inserted in the slot of the foot, and the thread end allowed to project over the rear edge of the foot by about $\frac{1}{2}$ inch. Now span the hole with wool as shown in Fig. b. Start at the left hand top corner of the damaged area and stretch wool sideways, i. e. from left to right and vice-versa, run by run, by shifting the fabric accordingly.

At the end of each run a zigzag stitch will tack the wool to the fabric when direction of movement is changed. Make sure that these runs are as close as possible, because later on no wool will be used. As soon as the damaged area is entirely covered with wool, the wool thread is cut at the darning foot. Now fasten the wool rows with zigzag stitches across them as shown in Fig. c, by shifting fabric forward and backward. Zigzag stitch is employed to ensure that the mend remains elastic, and care should be taken not to place the individual zigzag runs too closely together.

Applique Work

(Needle in position for left-hand stitch)

An attractive decorative effect is obtained by sewing cut-outs of materials of different colours or tulle to the cloth. Applique work is employed mainly on collars, ladies' and children's dresses, linen, and the like.

The buttonhole presser foot is advantageously employed for this type of work.

First draw the shapes to the *under side* of the material. The fabric from which the designs are cut should be of a pleasant contrast colour. Cut piece slightly larger than required and baste on the *right side* of the material. Then sew a narrow ($1\frac{1}{2}$) zigzag stitch row (not too short) along the shapes. The sewing thread should be of the same colour as the fabric applied. Then remove basting and trim along sewing line on right side. Now finish work by sewing a wider ($2\frac{1}{2}$), short zigzag line over the edges of the cut-out on the right side of the material.

Fig. 48



Zigzag Embroidering Foot (1 red line)

Zigzag Sewing Foot



Fig. 49

Ornamental stitches, hand-operated

The Zigzag Ornamental Stitch

With the Bernina Zigzag Sewing Machine Model 530-2 and Model 532-2 a variety of ornamental stitches can be produced in the simplest possible manner. According to the ornamental stitch desired, the stitch regulator 15 (Fig. 2) is more or less depressed and the zigzag knob 12 turned in both directions during sewing. After a few experimental stitches, the sewing of ornamental stitches becomes easy.

For ornamental stitches of normal stitch length (sample a in Fig. 51), use the zigzag sewing foot (Fig. 50). For stitches of very short length (sample b in Fig. 51), use the zigzag *embroidering* foot (Fig. 49). The latter has a recessed lower face.

Fig. 50

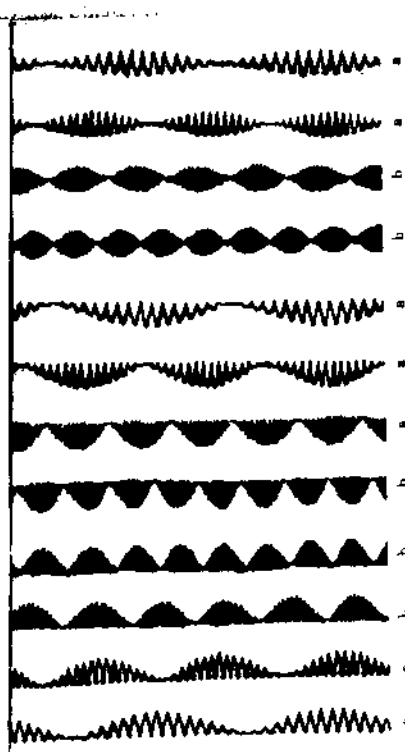

Fig. 51

Needle Position

combined

right

centre

left

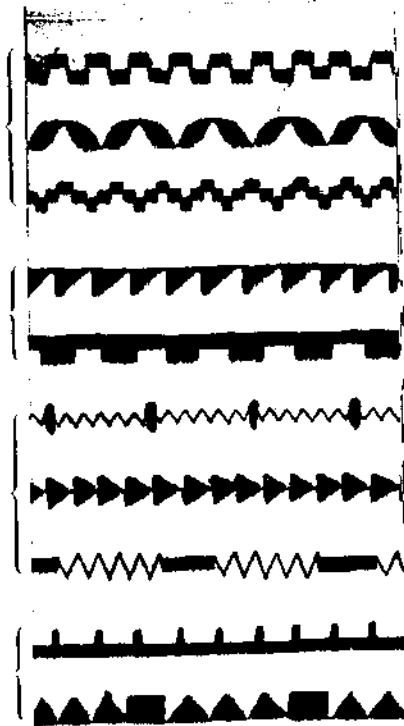

Fig. 52

a = normal stitch length, zigzag sewing foot
 b = short stitch length, zigzag embroidering foot } page 75

Zigzag Ornamental Stitches and their Combinations

As seen from the various descriptions, zigzag stitches are the result of the combination of

1. Stitch length (fabric feed) from zero to $\frac{1}{4}$ inch.
2. Stitch width (needle throw) from zero to $\frac{1}{4}$ inch.
3. Stitch location (adjustment left-centre-right).

Ornamental stitches are produced by adjustment of the control knobs during actual sewing.

When sewing with adjusted stitch length and width, the following designs are produced:

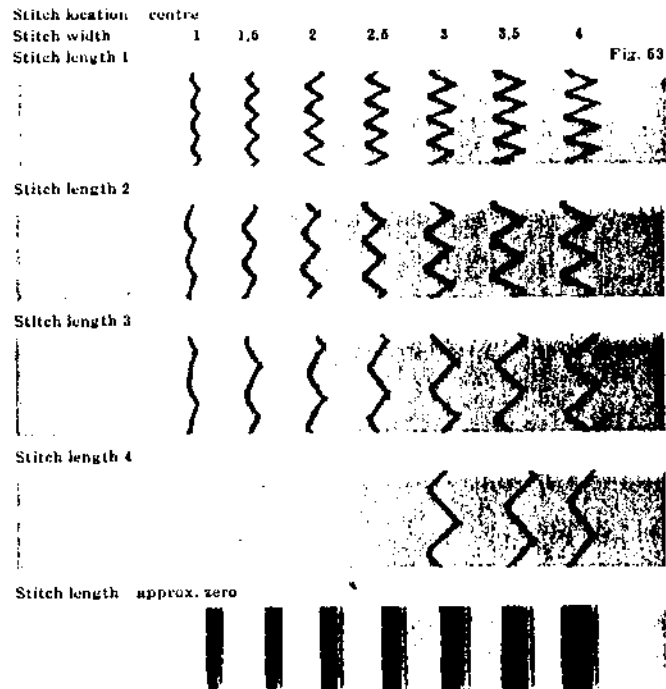

Naturally, intermediate values for both stitch width and length can be employed as well. Alteration, will produce width and needle position of stitch length, the following varieties:

Fig. 54

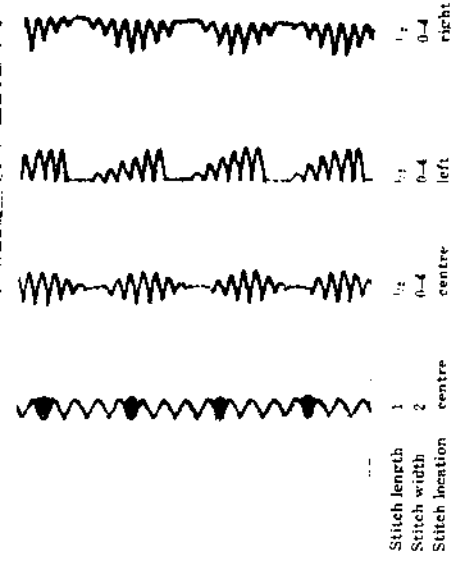

Fig. 55

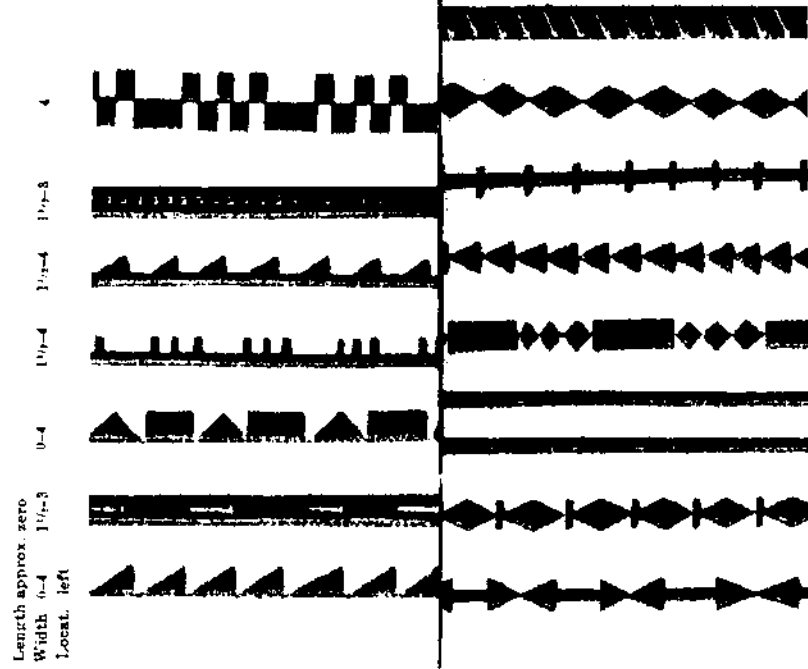

Fig. 56

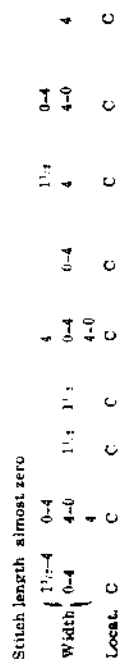
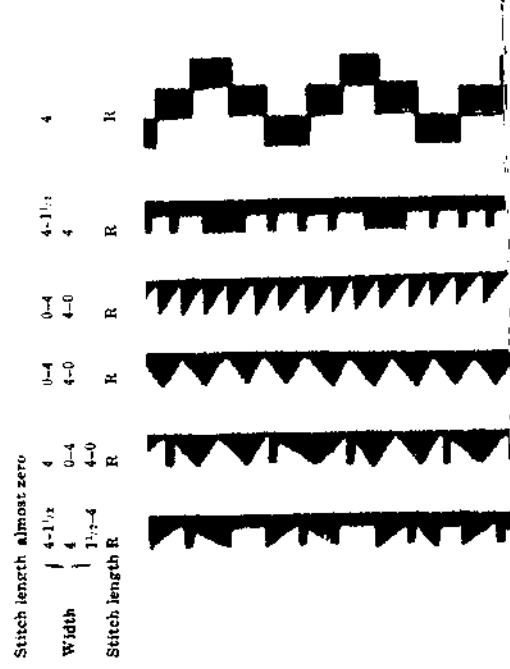

Fig. 57



Feather Stitch hand operated

- a) with one needle
- b) with two needles

Stitch length	almost zero	almost zero	almost zero
Stitch width	2 $\frac{3}{4}$	3 $\frac{1}{4}$	2
Stitch location	C	C	C

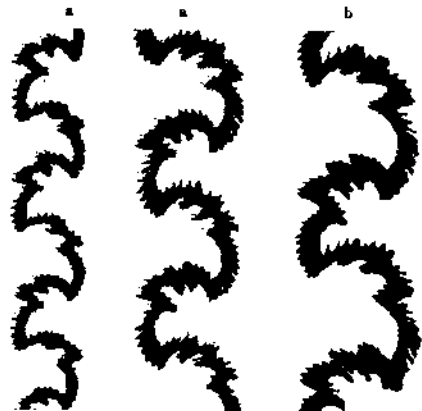

Fig. 62

Satin stitch control

Most ornamental stitches are sewn with a stitch length of "almost zero", i.e. with a very small material feed. If, between the making of such stitches, the machine is used with a larger material feed, e.g. for normal sewing jobs, the resetting of the stitch length to "almost zero" causes a little trouble and some waste of time. This defect is remedied by the built-in patented straight-sided satin stitch stop 58:59 (Fig. 2). If, for instance, you are doing normal sewing work with the stitch length 2 and want to change back to the straight-sided satin stitch,

then swivel the stop to the left by lifting handle 59, which projects from the vertical part of the frame, upwards until it meets with resistance, and move the stitch regulator knob 14 (Fig. 2) upwards as far as it will go. The straight-sided satin stitch can now be sewn without your needing to apply any hit-or-miss method. By pressing the handle 59 down, the normal position for the selection of the stitch length, forwards and backwards, is restored.

With a particular stitch length seams of varying thickness result according to the thickness of the yarn. The stop is thus set at the desired yarn thickness as follows: By turning knob 58 a very little to the right, the stitch length is shortened, which results in the seam being thicker; this is necessary when thin yarn is used. A very little turn to the left results in a slight increase in the little length so that a seam of uniform thickness can be achieved with thick yarn as well.

Automatic Fancy Stitches

Only applicable to Model 530-2

Every BERNINA Record Machine Model 530-2 is equipped with the automatic ornamental stitch device which enables ornamental stitches to be sewn without manipulation of the controls. Just select the pattern desired, set the control lever and then simply concentrate on guiding the fabric through the machine with both hands free to do so.

Adjustment for Automatic Ornamental Stitch Sewing

The lever 51 for zigzag or ornamental stitches is placed at the right-hand side of the top arm (Fig. 63). It projects from the slot in the plate 52. If the machine is to be set for control by the automatic ornamental stitch device, push lever 51 backwards. Reset for zigzag stitches by pulling lever forward.

At the left of the zigzag lever is placed the ornamental stitch selecting lever 54 which projects from the plate 53. This plate bears the symbols of the thirteen possible ornamental stitches. When sewing zigzag stitches, the lever 54 with its white line on the symbol side of the scale is set at zero, marked by a zigzag line, i. e. in front position.

Fig. 63

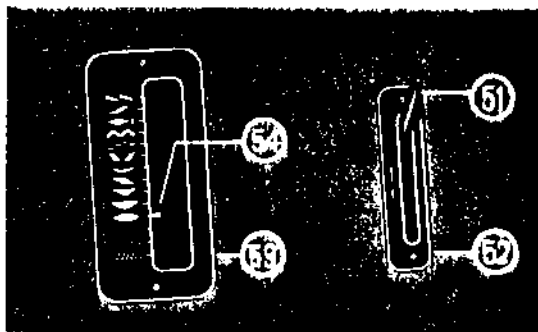

Select an ornamental stitch and set lever 54 at the corresponding symbol so that the white line thereon lines up with its mark.

This is effected as follows: Pull lever 54 to the right in its guiding slot, displacing it until its line and the stitch symbol line up and then release. It will automatically be locked and stay in this position. When displacing the lever, make sure that the needle is outside the fabric, i. e. in raised position. The stitch width adjusting knob 12 should be set so as to show the numeral 4 in the sight opening, i. e. to produce the largest stitch width.

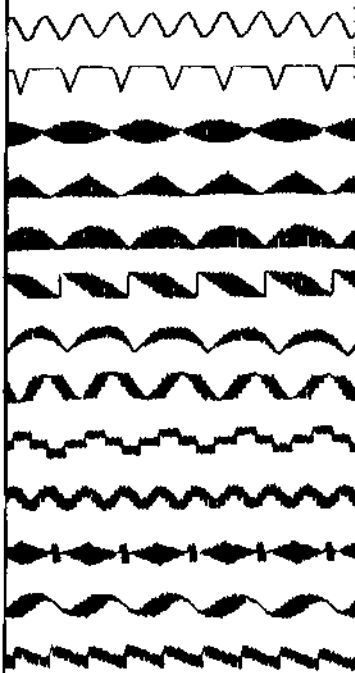

After threading the machine, stitching can be started in the same manner as ordinary sewing.

When switching back to normal zigzag stitches, place control lever in zero position as described above.

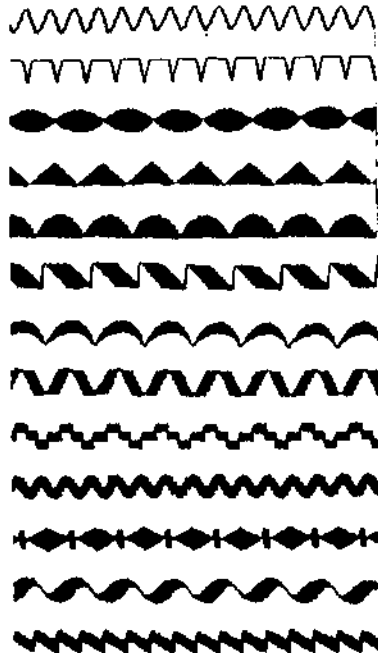

Stitch length alm. 0
Stitch width 4

Fig. 64

Fig. 65

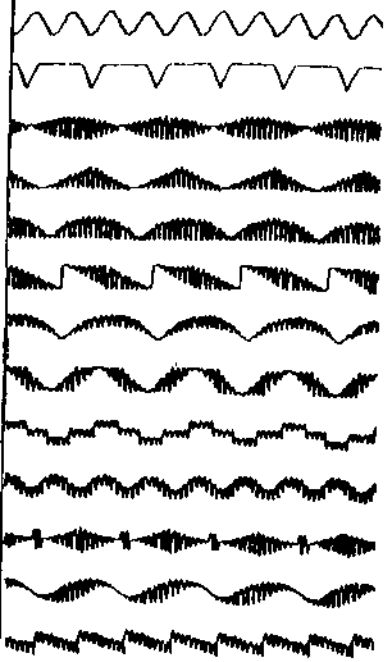

Automatic Ornamental Stitches with One Needle
Fig. 64

The stitch patterns may be varied by changing the stitch length from almost 0 to 4.

A further variation is possible by combining individual ornamental stitches during sewing as seen from the examples below:

- Combinations :
- a) Patterns combined longitudinally, Fig. 66
 - b) Patterns combined in groups fig. 68

Stitch length $\frac{1}{2}$
Stitch width 1

- Fig. 66

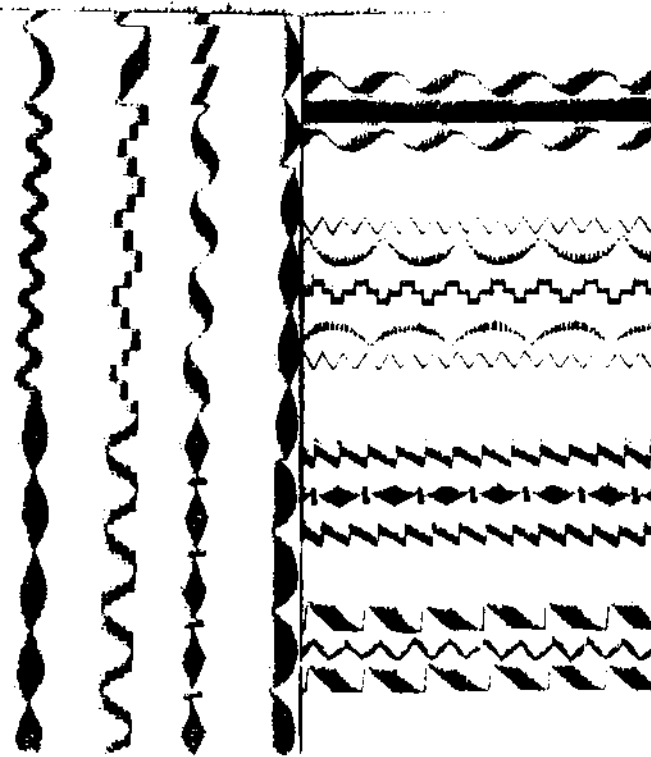

Fig. 67

Automatic Ornamental Stitches with Two Needles

Zigzag stitches are also possible when sewing with two needles. However, make sure that the two needles are not displaced further than allowed by the elongated hole in the throat plate.

Needle throw plus distance between needles equals width of elongated hole. When a double needle with $\frac{1}{12}$ inch needle distance is used, the stitch width must not exceed $\frac{1}{12}$ inch.

Naturally ornamental stitches made with two needles may also be modified by altering the material feed and by thread selection (2 colours).

- Fig. 68

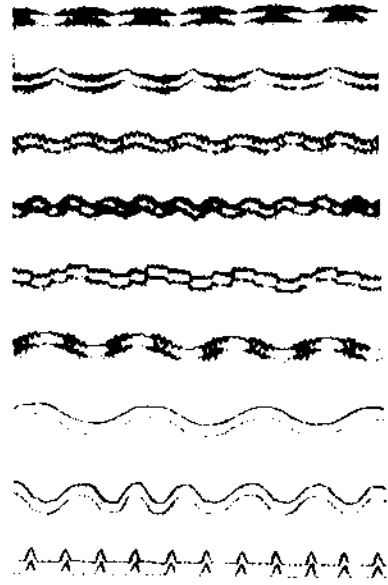

Fig. 69

Blindstitch sewing

Blindstitch sewing means sewing together two pieces of cloth, the upper one being folded and sewn to the lower one in such manner that the stitches are invisible on one side. Such work is done with the blindstitch foot which has an elastic cloth guide between the fingers of the base, but otherwise is identical to an ordinary presser foot.

Blind stitch sewing can be accomplished with the ordinary zigzag stitch or by means of the automatic built-in blindstitch cam.

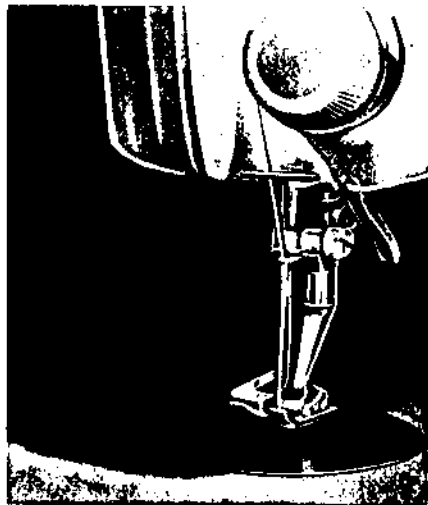

Fig. 70

Plan Sketch

- ① Blindstitch foot
(No. 53 06 82 02)
- ② Left position of needle
- ③ Folded upper piece of material
- ④ Needle plate
- ⑤ Material stop and guide
- ⑥ Right position of needle

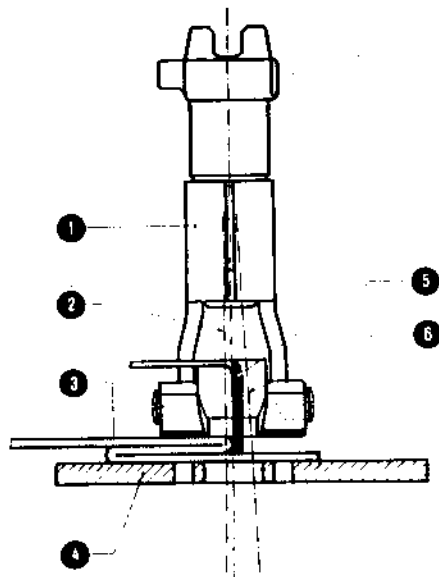

Fig. 71

1) Setting of machine when using, ordinary zigzag stitch

- a) Attach blindstitch foot
- b) Deflect needle to right position
- c) Set zigzag knob to a stitch width between 2 and 3 according to thickness of material
- d) Set stitch length to 4
- e) Set feed dog for normal sewing.

After having threaded the machine, put the lower flat piece of material underneath the blindstitch foot, then put the upper piece of material on top and fold it in such manner that it always touches the elastic guide, lower the blindstitch foot and start sewing.

The zigzag stitch width is to set in such manner that the needle on its left deflection is stitching through the middle of the folded piece of material, which will make the seam invisible on the upper piece of material, when flattened. Such stitch width is, depending from thickness of material used, between 2 and 3.

2) Setting of machine for automatic blindstitching

When blindstitching with the ordinary zigzag stitch, the folded piece of material is pierced on every second stitch; when using the automatic blindstitch cam, there are five straight stitches between each piercing of the folded piece of material. The machine is set as follows:

- a) Attach blindstitch foot
- b) Push zigzag ornamental stitch lever 51 (Fig. 63) to the back (1-13)
- c) Put ornamental stitch selector 54 to blindstitch pattern (1)
- d) Set needle to centre position
- e) Set zigzag knob to a stitch width between 2 and 3 according to thickness of material
- f) Set stitch length to 2, 3 or 4 according to kind of material
- g) Set feed dog for normal sewing.

The blindstitching then is done as mentioned under 1).

Pintucking

The complete pin-tucking attachment comprises the following members:
3 double needles for pin-tucks of approx. $\frac{1}{12}$, $\frac{1}{8}$ and $\frac{1}{4}$ inch width
3 pin-tuckers with 3, 5 and 7 grooves

Fig. 72

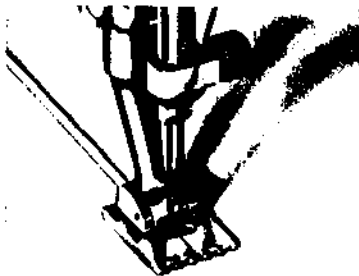

- 1 pin-tucking tongue
- 1 pin-tucking yarn threader

When preparing the machine for pin-tucking, proceed as follows:

1. Set needle to centre position in hole by adjusting control 13 (Fig. 2) to centre.
2. Set zigzag lever 12 (Fig. 2) to zero.
3. Remove standard needle from needle bar and insert a double needle (proceed as for standard needle).
4. Attach the pin-tucking foot corresponding to the needle distance, namely:
pin-tucker with 7 grooves / double needle of $\frac{1}{12}$ "
pin-tucker with 5 grooves / double needle of $\frac{1}{8}$ "
pin-tucker with 3 grooves / double needle of $\frac{1}{4}$ "

- 4 Thread tension
- 7 Take-up lever
- 8 Thread guide
- 22 Spool pins
- 32 Thread guide
- 33 Thread guide



Fig. 73

Threading the two Top Threads Fig. 73

To thread the machine for pin-tucking with two top threads, proceed as for normal sewing. The thread spools are slipped on the double spool holder with the two spool pins 22 at the rear of the machine. The thread of the left reel is passed through the rear eyelet 8 on the top of the stand, hence to the eyelet 8 in front and through the rear thread tension disc which is separated from the front disc by an intermediate disc. Then pass the thread through the upper opening of the take-up lever 7, down behind the thread guide 32 on the stand and then into the needle holder eyelet 33 and finally through the left-hand needle eye. The second thread is threaded similarly, but passed through the front thread tensioner to the lower hole in the thread take-up lever 7, and through the right-hand needle eye.

Both threads should be separate in the thread tensioner since better pin-tucks are obtained that way.

Pin-tucking Fig. 74

A pin-tuck is formed by the bottom thread which pulls the two top threads together so that the fabric between the two needles is raised into a tuck.

For pin-tucks with inserted cord, the insert is passed, from the ball slipped on a thread reel pin of the container, through the groove in the flap, through the hole in the throat plate between the two teeth rows of the feed dog, and passed away from operator below the pin-tucking foot.

Ornamental Stitch with Double Needle

When using one pin-tucking needle and the standard zigzag foot, a parallel double ornamental stitch can be produced, the two threads being preferably of different colours.

When using a double needle with $\frac{1}{12}$ and $\frac{1}{8}$ inch gap, an additional zigzag motion can be performed. The needle deflection should only be so large that neither needle fouls the stitch hole either on the left or on the right. The zigzag lever 12 (Fig. 2) should therefore be moved slightly to the left of zero point.

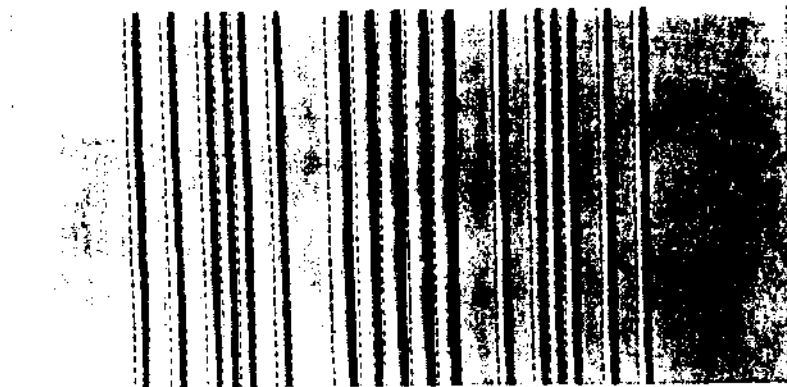

Fig. 74

Embroidering around holes

The complete equipment for embroidering around holes, which is not part of the standard accessories, comprises the following components :

- 53 06 62 Hole embroidery foot
- 53 06 60 Needle plate complete with slide for holes
- 54 12 01-01 Embroidery ring
- 54 11 05 Square piercer
- 54 11 06 Round piercer

This simple device permits sewing fashionable "Broderie Anglais" and circular embroideries on the Bernina-Record and 532. It allows sewing around holes of various sizes and making circular embroideries up to approximately 1 inch in diameter. In both cases the stitch width may be varied during the operation of sewing around.

For hole embroidering set the machine as follows :

1. set needle to left position by turning lever 13 (Fig. 2) to the left;
2. lower feed dog by turning control lever 17 (Fig. 2) to the left for darning symbol;
3. replace ordinary needle plate with hole embroidery needle plate complete with slide, attach hole embroidery presser foot.

Always use the embroidery frame. We recommend winding strips of cloth around its outer ring to obtain better tension of the material and to prevent damage to it. Only after clamping the material in such manner, punch the holes with the piercers supplied. It is of advantage to previously mark the holes on the material by means of a pencil or the like. Then place the material under the hole embroidery foot so that the guide pin of the slide projects through the hole. As mentioned before, the needle is to set in left position (page 44, Fig. 23 b).



Position of slide for hole embroidery



Fig. 75

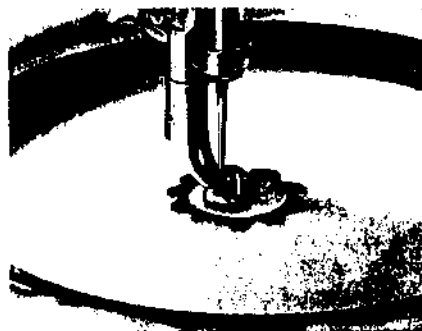

Embroidering is performed in the embroidery frame

Fig. 76



Position of slide for circular embroidery

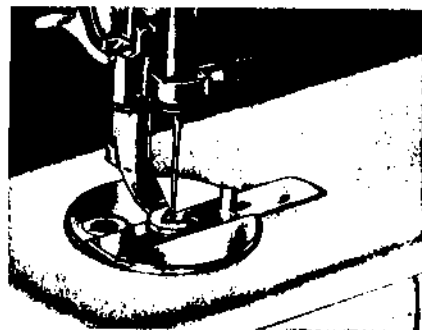

Fig. 77

For both top and bottom embroidery thread No. 60-80 is used, which gives the best results in even sewing around holes. For hole embroidery the thread tension is of utmost importance. The bottom thread tension should be slightly higher than that of the top thread, so that the thread knots will only show on the lower face of the material.

The slide in the embroidery plate should be so positioned that the needle, when effecting a right-hand stitch, enters in the recess of the guide pin just beyond the edge of the material. This setting is altered according to stitch length and should therefore be repeated. Then allow the machine to operate at regular speed, at the same time turning

the embroidery ring three or four times around the guide pin at the same regular speed in clockwise direction. Then set zigzag knob 12 (Fig. 2) to zero and secure the thread by a few stitches. These binding stitches should be parallel to the embroidery stitches so that they remain practically invisible.

When the slide of the embroidery plate is reversed, as shown in Fig. 77, the guide pin can be used as a centre in sewing circular embroidery. The needle stitches through the elongated slot of the slide. By changing the stitch width, i.e. varying the speed of rotation of the embroidery ring during the stitching, or by the use of threads of different colours, vary attractive and varied patterns can be produced.

When embroidering around holes, observe the general rule that holes of the same size should be finished successively so that the slide need not be changed too frequently.

Useful Hints

Causes and Elimination of Little Troubles

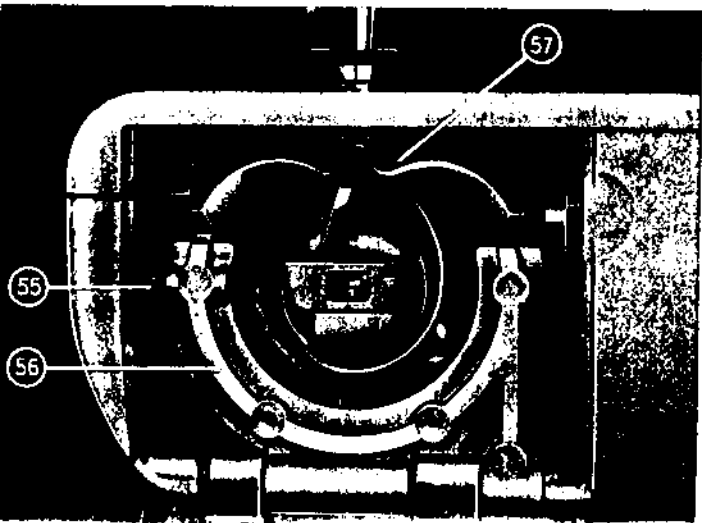

Fig. 78

Blocked Shuttle

If the machine should fail to run either forward or in reverse or if an abnormally loud noise is heard, a thread has become jammed in the shuttle race owing to faulty manipulation. In such cases, the race can easily be cleared. Raise needle bar to its extreme position, depress spring lever member 55 (on the left of the shuttle race) with left-hand thumb so that the lock-

ing bridge 56 can be swivelled down together with the shuttle race cover 57. After removal of bobbin case and shuttle, it will be easy to remove jammed thread ends and dust from the shuttle race. Do not use hard instruments, such as screw-drivers, etc., to avoid damaging the shuttle race. After cleaning, first replace shuttle, and swing the locking bridge 56 and shuttle wall cover 57 into position shown in Fig. 78. Then press with the thumb on the spot marked with an arrow until the locking bridge rams home, and finally replace bobbin case. Make sure that the locking bridge is properly engaged.

Top Thread Breakage

- Needle of inferior quality, badly polished needle.
- Needle not properly inserted. Long groove must face front.
- Needle blunt or bent.
- Needle too fine in relation to thread used.
- Top thread tension too tight.
- Thread passages not polished.
- Thread control spring broken.
- Needle hole in throat plate damaged by needle, requires repolishing.
- Shuttle point has become too sharp by needle action (Call mechanic).
- Shuttle race not oiled.
- Inferior thread or knotted thread.
- Thread dried out in storage. Threads should never be kept in heated rooms.

Bottom Thread Breakage

- Bottom thread tension too tight.
- Bottom thread not properly wound on bobbin.

Bobbin deformed or jamming in case.
Needle hole in throat plate damaged by needle, requires repolishing.

Faulty Stitches

Unsuitable needle. Use needles System 705.
Needle blunt or bent.
Needle not properly inserted. Long groove must face front. Push needle home completely.
Inferior, badly polished needle.
Cheap needles often tear thread and break easily. This may cause costly damage to throat plate and feed dog.
The best needle is the most economical in use.
Needle not in proper relation to thread number.

Needle Breakage

Needle bent.
Needle too fine in relation to thread.
Needle holding screw not properly tightened.
Top thread tension excessive.

When the work is pulled towards the operator on completion, the needle often bends. When the needle performs the first stitch subsequently, it fouls the throat plate and breaks. Therefore always pull work away from you from under the presser foot.

During sewing, however, the work should not be pulled away from you too hard.

Use of cheap thread which is unevenly twisted or even knotty. A single knot on a thread reel may break the needle and even damage the throat plate so that far more expense may ensue than by securing the best possible thread.

Slow Operation of Machine

Motor too heavily oiled causing collector to be oily. (See Instructions for Lubrication on Page 27.) Call mechanic!

Machine (not motor) insufficiently oiled.
Thread ends in the shuttle race.

Machine blocked by resinified oil. Flush machine with petrol and oil again. In stubborn cases, the machine must be disassembled. If machine has stood in a cold room, it should be placed in a warm room, open, for about one hour so that it will assume room temperature and the oil in the bearings can get liquid again.

Work Puckers

In most cases this is caused by excessive tension in relation to type of work. When sewing Knitted Goods, never pull work away from you with your hands which will cause work to pucker. It is advantageous, on the contrary, to assist the forward movement by pushing.