

CABINET TYPE AIR CONDITIONER

Operation & Installation Manual

HPU-42CH03

HPU-48CJ03

HPU-48HJ03

HPU-42HH03

HPU-42HI03

HPU-48HK03

HPU-48CK03

No.0150509772

B

- Please read this operation manual before using the air conditioner.
- Please keep this manual carefully and safely.

■ Content

Operation

Cautions	1-2
Parts	3
Operation hints	4
Energy saving	5
Maintenance	6-7
Trouble shooting	8
When problems occur	9-10
Indoor & outdoor unit connection	11
Tools necessary	12
Installation procedures	13-18
Others	19

■ Cautions

Disposal of the old air conditioner

Before disposing an old air conditioner that goes out of use, please make sure it's inoperative and safe. Unplug the air conditioner in order to avoid the risk of child entrapment.

It must be noticed that air conditioner system contains refrigerants, which require specialized waste disposal. The valuable materials contained in a air conditioner can be recycled. Contact your local waste disposal center for proper disposal of an old air conditioner and contact your local authority or your dealer if you have any question. Please ensure that the pipework of your air conditioner does not get damaged prior to being picked up by the relevant waste disposal center, and contribute to environmental awareness by insisting on an appropriate, anti-pollution method of disposal.

Disposal of the packaging of your new air conditioner

All the packaging materials employed in the package of your new air conditioner may be disposed without any danger to the environment.

The cardboard box may be broken or cut into smaller pieces and given to a waste paper disposal service. The wrapping bag made of polyethylene and the polyethylene foam pads contain no fluorochloric hydrocarbon.

All these valuable materials may be taken to a waste collecting center and used again after adequate recycling.

Consult your local authorities for the name and address of the waste materials collecting centers and waste paper disposal services nearest to your house.

Safety Instructions and Warnings

Before starting the air conditioner, read the information given in the User's Guide carefully. The User's Guide contains very important observations relating to the assembly, operation and maintenance of the air conditioner.

The manufacturer does not accept responsibility for any damages that may arise due to non-observation of the following instruction.

- Damaged air conditioners are not to be put into operation. In case of doubt, consult your supplier.
- Use of the air conditioner is to be carried out in strict compliance with the relative instructions set forth in the User's Guide.
- Installation shall be done by professional people, don't install unit by yourself.

■ Cautions

- For the purpose of safety, the air conditioner must be properly grounded in accordance with specifications.

- Always remember to unplug the air conditioner before opening inlet grill. Never unplug your air conditioner by pulling on the power cord. Always grip plug firmly and pull straight out from the outlet.

- All electrical repairs must be carried out by qualified electricians. Inadequate repairs may result in a major source of danger for the user of the air conditioner.

- Do not damage any parts of the air conditioner that carry refrigerant by piercing or perforating the air conditioner's tubes with sharp or pointed items, crushing or twisting any tubes, or scraping the coatings off the surfaces. If the refrigerant spurts out and gets into eyes, it may result in serious eye injuries.

- Do not obstruct or cover the ventilation grille of the air conditioner. Do not put fingers or any other things into the inlet/outlet and swing louver.

- Do not allow children to play with the air conditioner. In no case should children be allowed to sit on the outdoor unit.

Specifications

- The refrigerating circuit is leak-proof.

The machine is adaptive in following situation

Applicable ambient temperature range:

			Rated	Maximum	Minimum
Cooling	Indoor	DB °C	27	32	18
		WB °C	19	23	14
	outdoor	DB °C	35	43	10
		WB °C	24	26	6
Heating	Indoor	DB °C	20	27	15
		WB °C	14.5	--	--
	outdoor	DB °C	7	24	-7
		WB °C	6	18	--

Parts

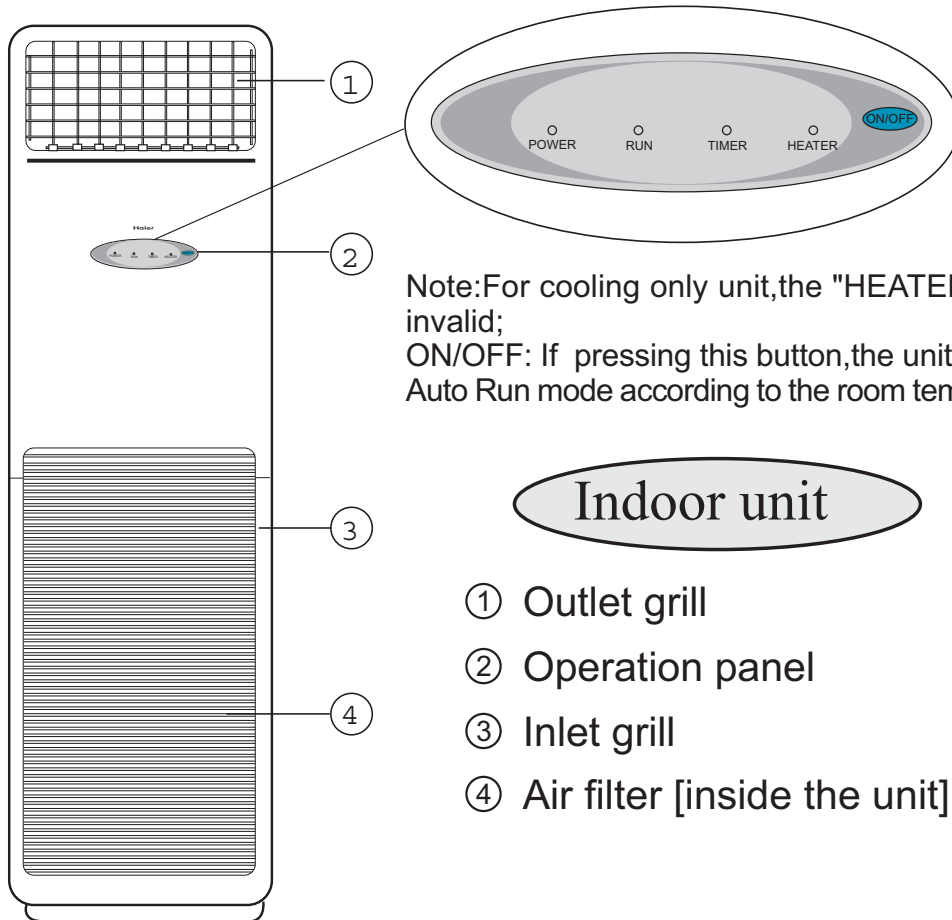

Note: For cooling only unit, the "HEATER" light is invalid;
 ON/OFF: If pressing this button, the unit will enter Auto Run mode according to the room temperature.

Indoor unit

- ① Outlet grill
- ② Operation panel
- ③ Inlet grill
- ④ Air filter [inside the unit]

Outdoor unit

- ① Inlet grill
- ② Outlet grill

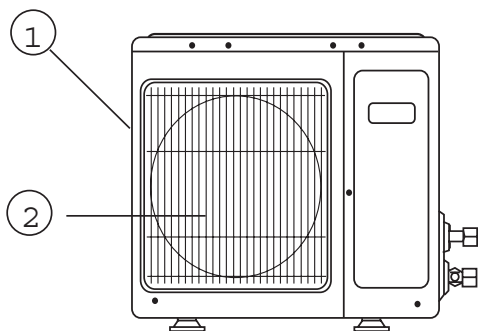

HPU-42CH03 HPU-48CJ03
 HPU-42HH03 HPU-48HJ03

Remote controller

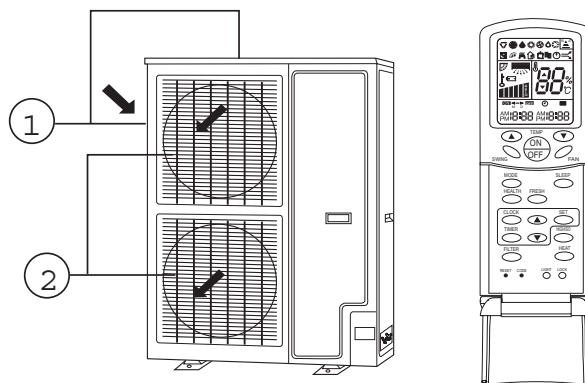

HPU-42HI03 HPU-48HK03
 HPU-48CK03

■ Operation hints

Unit operation

- Protection devices inside the unit will activate to stop unit operation, when ambient temp. is extremely low or high.
- When unit is running under high humidity in cooling or dehumidifying mode, condensate might appear at outlet grill.

3-min delay protection

- Unit will not restart until 3 min have elapsed for the protection of the unit.

Fan speed changes

- When Fan speed is set at Auto in cooling mode, it will be automatically reduced as room temp. is approaching temp. setting.
- In dry mode, fan speed will change automatically.

Cold draft prevention

- In heating mode, indoor fan will not run for the first 2-5 min. due to cold draft prevention.

Defrosting

- When frost accumulates on heat exchanger in heating mode, unit will start defrosting automatically.
- During defrosting, both indoor and outdoor fan stop.
- After defrosting, unit resumes running.

Use objectively

- Heat pump works by means of absorbing outside heat to warm room air, so outdoor temp. degree will affect unit's heating efficiency.

Energy saving

Keep proper room temp.

Too cold or too warm is no good to your health, and power consumption will be increased as well.

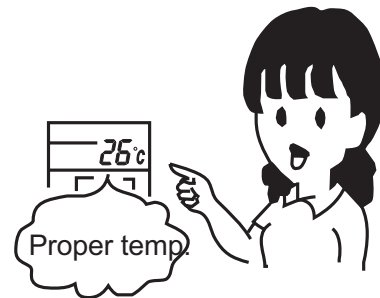

Air filter should be periodically cleaned

If air filter is clogged:

It will cause poor cooling and heating efficiency, higher power consumption and even problem may occur. In cooling operation, water will flow out.

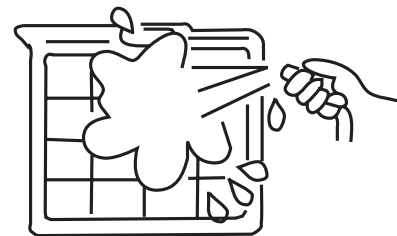

Use Timer effectively

You may use Timer mode to keep a comfortable room temp. when you wake up or come home from outside.

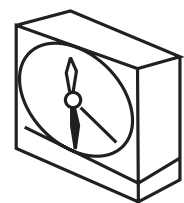
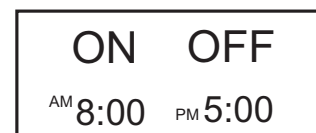

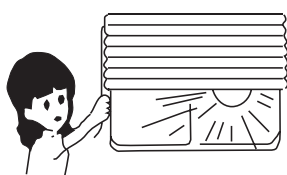

Avoid direct sunlight and air flow



Adjust air flow properly

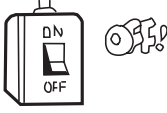

Maintenance

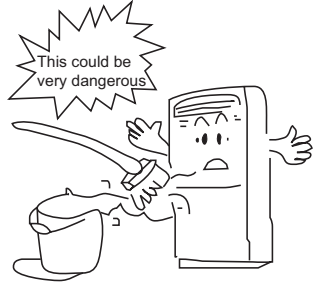
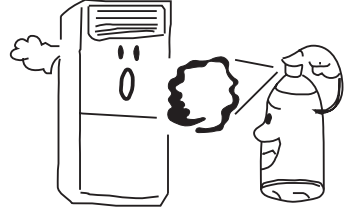
<p>Disconnect power supply</p>	<p>Don't touch it with wet hand</p>	<p>Don't wash with hot water or solvent to clean the unit</p>
		
<p>Don't splash water directly on indoor unit.</p> 		<p>Don't spray any paint or insecticide on the unit.</p>  <p>This will cause damage or even fire accident.</p>

Air filter cleaning

- Pull it out from top as shown in Fig.
- Use water or vacuum cleaner to clean it. If it is extremely dirty, wash it with neutral detergent or soap water.
- Wash it with clean water and install it after complete dry.

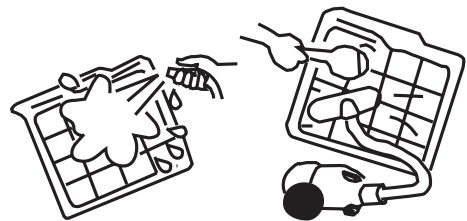
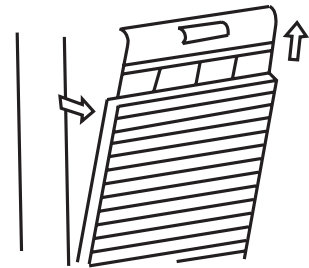

Caution:

- Don't use hot water over 40 °C, as this may cause damage to air filter.
- Wipe air filter carefully.

■ Maintenance

Indoor and outdoor cleaning

- Clean it with warm and wet cloth or with neutral detergent, then wipe it dry with clean and soft cloth.
- If air conditioner is very dirty, clean it with cloth soaked in neutral detergent, then wipe off the detergent with clean water.
- Don't use water higher than 40°C, which will cause discoloring and deformation.
- Don't use insecticide or other chemical detergents.

After season maintenance

- Let the unit run in Fan mode for half a day in a fine weather to dry completely the unit inside.
- Turn off the unit and pull out power plug.
- There might be certain power consumption even if unit is stopped.
- Clean air filter and indoor unit, cover outdoor unit after cleaning.

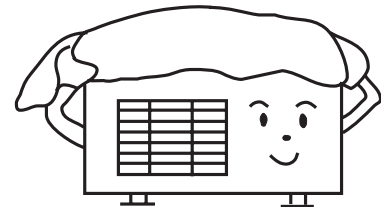
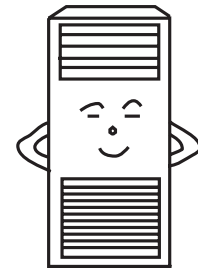

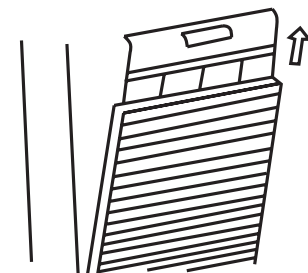

Before season maintenance

- Check if there are obstacles at inlet and outlet of indoor and outdoor unit, which will reduce unit efficiency.
- Don't fail to attach air filter after making sure it is cleaned.
- Dust will enter into unit causing damages or faults if it is running without air filter.
- To protect compressor at start, please connect external power supply to the unit 12 hrs prior to starting. Also please keep the power supply switch ON during the whole season.



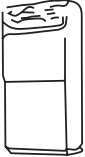

■ Trouble shooting

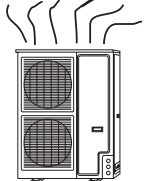
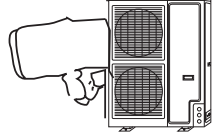
Followings are not problems

<p>Sound of water flowings are not problems.</p> 	<p>During unit start and operation or at stop, a swishing or gurgling noise may be heard. This noise is generated by refrigerant flowing in the system.</p>
<p>Sound of cracking is heard.</p>	<p>During unit operation, a cracking noise may be heard. This noise is generated by the casing expanding or shrinking because of temperature changes.</p>
<p>Smells are generated.</p>	<p>This is because the system circulates smells from the interior air such as the smell of cigarettes or the painting on the unit.</p>
<p>During operation, white fog or steam comes out of indoor unit.</p> 	<p>When unit is running at places like restaurant where dense edible oil fumes always exist, this will happen.</p>
<p>In cooling operation, unit switches to fan operation.</p>	<p>To prevent frost from accumulating on indoor heat exchanger, unit will switch to fan operation for a while then resume cooling operation.</p>
<p>Unit will not restart after stop. Won't start?</p> 	<p>Though ON/OFF button is set to ON, unit won't resume cooling, dry or heating operation in 3 min after it is stopped, this is because of 3-min-delay protection circuit.</p>  <p style="text-align: center;">Please wait 3 minutes</p>
<p>No outlet air or fan speed can't be changed in dry mode.</p>	<p>Unit will reduce fan speed repeatedly and automatically if room temp. is too low in dry operation.</p>
<p>In heating operation, water or steam are blown out of indoor unit.</p> 	<p>This occurs when frost accumulated on the outdoor unit is removed. (during defrosting operation)</p> 
<p>In heating operation, indoor fan won't stop even if unit is stopped.</p>	<p>After unit stops, indoor fan will go on running until indoor unit cools down.</p>

■ When problems occur

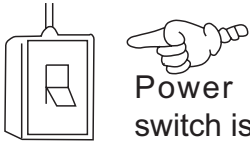
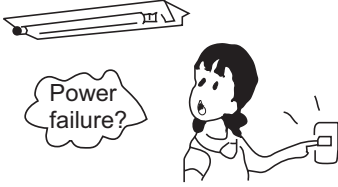
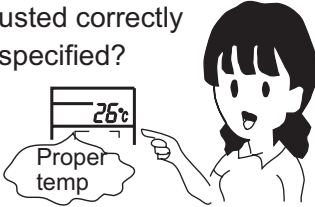
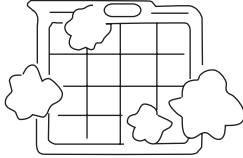
Before asking services, please firstly check your unit according to following.

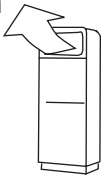
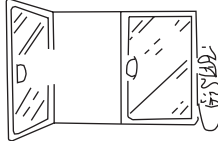
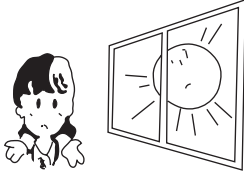
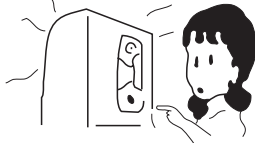
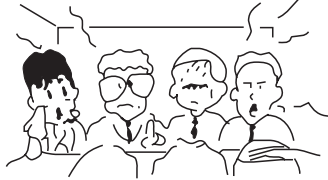
Air conditioner won't start.		
<p>Is power supply switch turned on?</p>  <p>Power supply switch is not set at ON.</p>	<p>Is city power supply normal?</p>  <p>Power failure?</p>	<p>Is leakage current breaker activated?</p> <p>This is very dangerous, please disconnect power supply immediately and contact your dealer.</p>
Poor cooling or heating		
<p>Are operation controls adjusted correctly as specified?</p>  <p>Proper temp</p>	<p>Is air filter too dirty?</p> 	<p>Are there any obstacles at inlet or outlet grill?</p> 
<p>Are horizontal louvers at up position (in heating mode)?</p> 	<p>Any doors or windows left open?</p> 	
Poor cooling		
<p>Is there any direct sunlight in the room?</p> 	<p>If there are unexpected heat sources in the room?</p> 	<p>Too many people in the room?</p> 

If your unit still can't work properly after above mentioned checks, or following problems occur, please stop it immediately and contact your dealer.

- Fuses or circuit breakers often blow out.
- Water comes out in cooling/dry operation.
- Operation is abnormal or sound is heard.

If the fuse on PC board is broken please change it with the type of T6.3A/250VAC.

■ When problems occur

Power supply

- The parameter of power cord is over 5G 2.5mm².
- The parameter of connect cord is 4G 0.75mm².
- Air conditioner must use an exclusive line (over 30A)
- When installation air conditioner in a wet place, try to use a circuit breaker against current leakage.
- For installation in other places, use circuit breaker as far as possible.
- The breaker of the air conditioner should be all-pole switch ; and the distance between its two contacts should be no less than 3 mm.
- Such means for disconnection must be incorporation in the fixed wiring

Indoor & outdoor unit connection

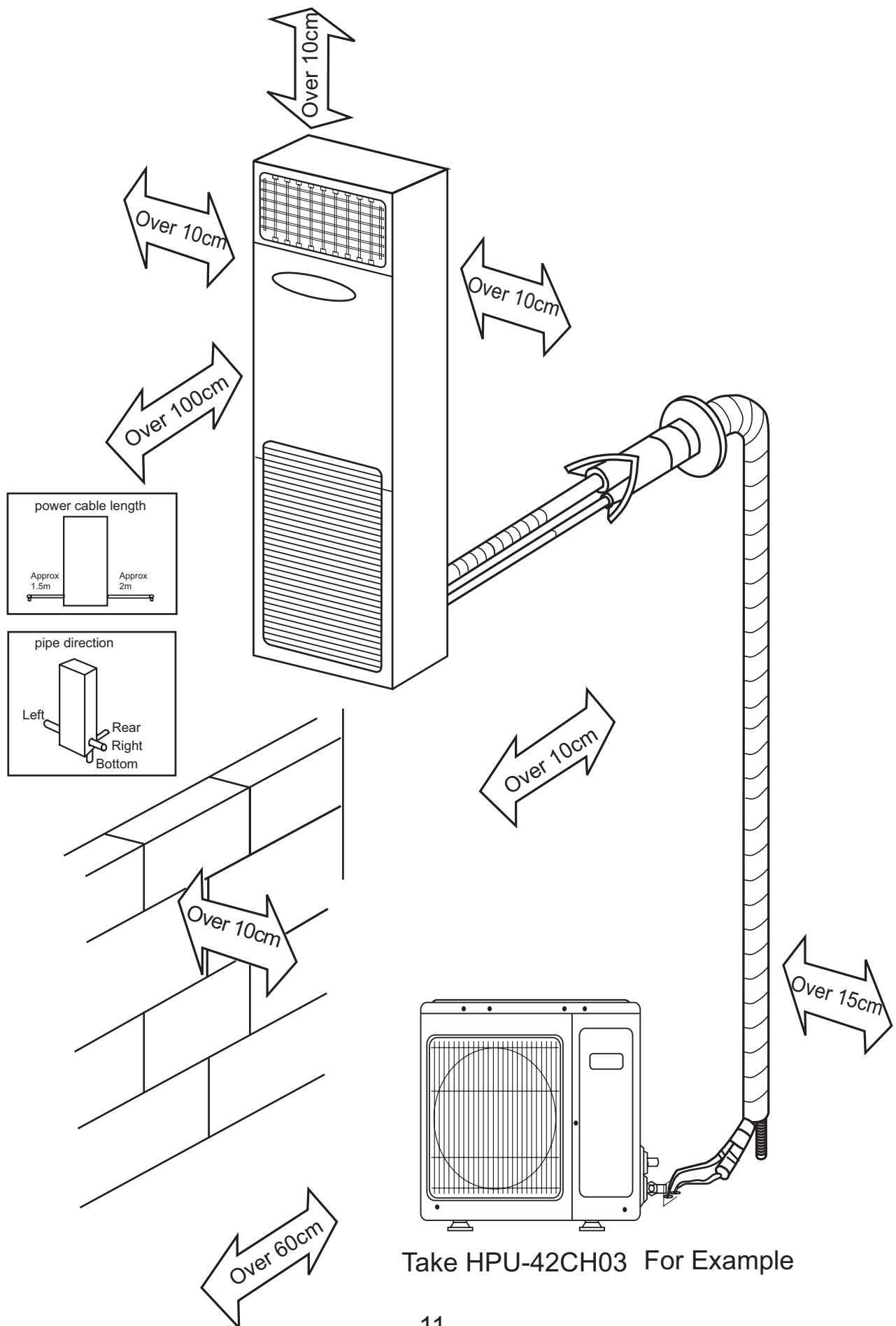

■ Tools necessary

Tools necessary

1. Screw driver
2. Hacksaw
3. 70mm dia. hole core drill
4. Spanner (dia. 17, 27mm)
5. Spanner (14, 17, 27mm)
6. Pipe cutter
7. Flaring tool
8. Knife
9. Nipper
10. Gas leakage detector or soap water
11. Measuring tape
12. Reamer
13. Refrigerant oil

Standard accessories

Following parts shall be field supplied

Mark	Parts name
Ⓐ	Adhesive tape
Ⓑ	Pipe clip
Ⓒ	Drain hose

■ Installation procedures

Display of whole unit

- Try to bring the packed unit to the installation place.
- When it is inevitable to unpack the unit, be careful not to damage the unit. Wrap it with nylon etc.
- After unpacking, be sure to put it with the front side of the unit facing up.

Delivery

- Note: When delivering, don't hold plastic parts like inlet and outlet grill etc.

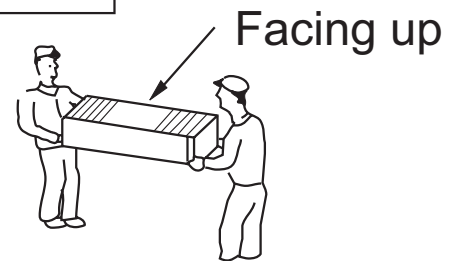

Installation of outdoor unit

Selection of installation place

- Place strong enough to support the unit and will not cause vibration and noise.
- Place where discharged wind and noise doesn't cause a nuisance to the neighbors.
- Place where is less affected by rain or direct sunlight and is sufficiently ventilated, or to install a shield.
- Place with enough space for smooth air flow.

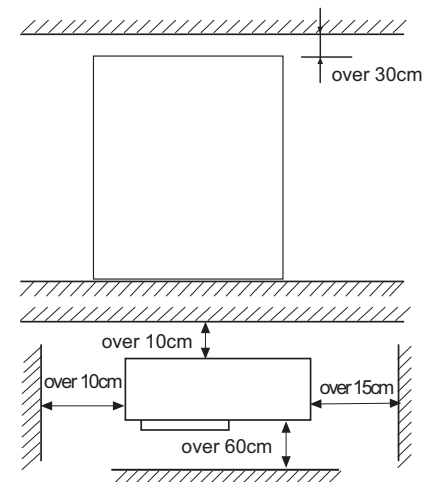

Fixing of the unit

- Fix outdoor unit using M10 bolt to concrete floor horizontally.
- If installed on the wall or on top of a roof, bracket should be fixed securely to resist earthquake or storms.
- Use rubber pad during installation against unit vibration.

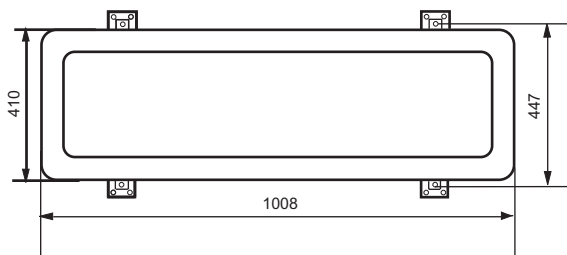

HPU-42CH03 HPU-48CJ03
HPU-42HH03 HPU-48HJ03

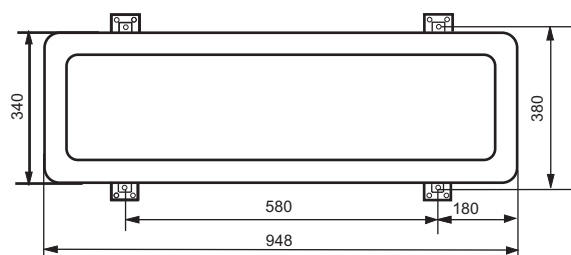

HPU-42HI03 HPU-48HK03
HPU-48CK03

Installation dimension of outdoor unit (mm)

■ Installation procedures

Installation of indoor unit

Selection of installation place

Place where it is easy to route drainage pipe and outdoor piping.

Place away from heat source and with less direct sunlight.

Place where cool and warm air could be delivered evenly to every corner of the room.

Place near power supply socket. Leave enough space around the unit (refer to installation drawings).

Fixing of the unit

1. Position of the wall hole

Wall hole should be decided according to installation place and piping direction. (refer to installation drawings)

2. Making a wall hole

Drill a hole of 70mm dia. with a little slope towards outside.

Install piping hole cover and seal it with putty after installation.

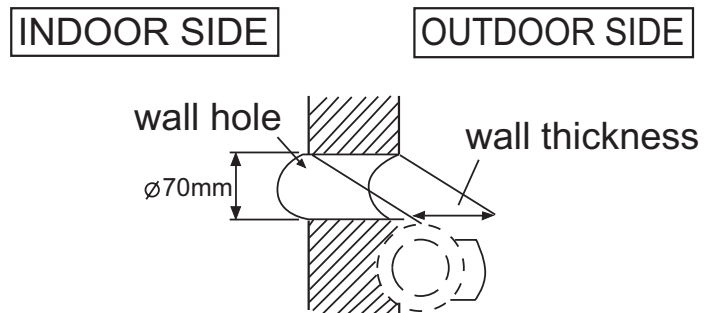

(Cross section of wall hole)

Fixing of indoor unit

To prevent it from fall off, please fix the unit with fall-prevention fitting at wall and L-shaped metal at floor.

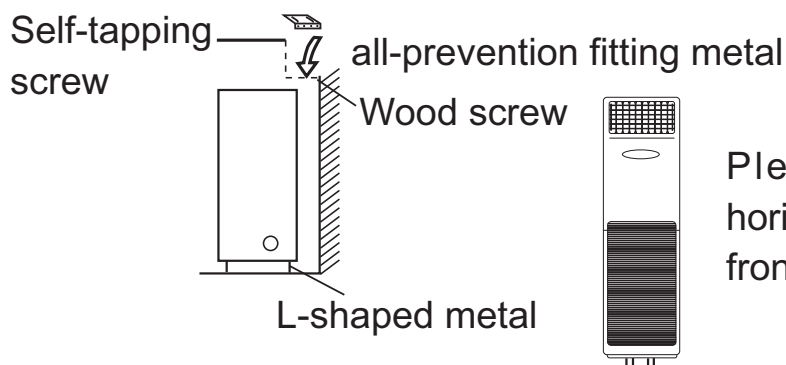

Please install the whole unit horizontally, with a slop of 1 degree at front and rear, left and right.

■ Installation procedures

Installation of fall-prevention fitting metal:

Fix the fitting metal to the wall by screws so that there is no clearance between them. With the unit set up vertically, fix the fitting metal to the unit with screws while making an adjustment at the long portion of the hole so that there is no clearance between the upper surface and the fitting metal.

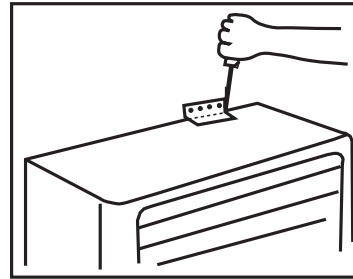
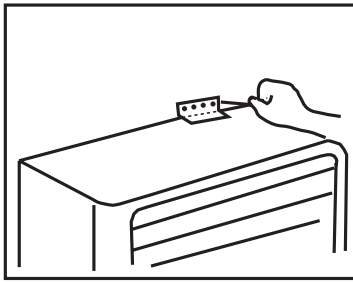

Installation of L-shaped metal

Fix to the unit by screws so that there is no clearance between the fitting metal and the unit.

After confirming that the unit has been set up vertically to the floor, fix it to the floor by bolt.

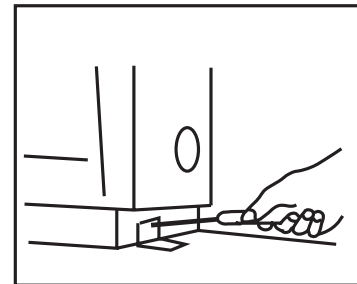
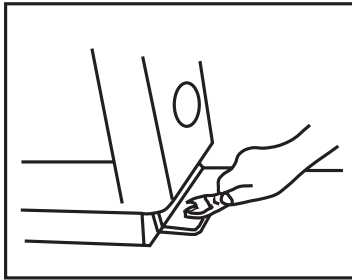

Piping connection

1. Connecting method

Apply refrigerant oil at half union and flare nut.

To bend a pipe, give the roundness as large as possible not to crash the pipe.

When connecting pipe, hold the pipe centre to centre then screw nut on by hand, refer to Fig.

Be careful not to let sundries, such as sands enter the pipe.

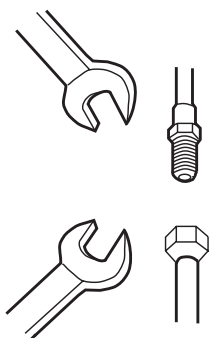

Forced fastening without centering may damage the threads and cause a gas leakage.

Pipe dia	Fastening torque
Liquid pipe 9.52mm(3/8")	29.4N·m
Gas pipe 19.05mm(3/4")	117.7N·m

■ Installation procedures

2. Piping connection of indoor unit

Arrangement of piping and drainage pipe

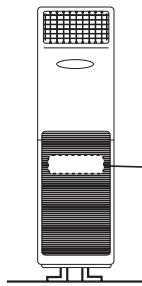

After opening inlet grill, you will see a control box as shown in the Fig.

Remove the cover before wiring work.

Cut away, with a hammer or a saw, the lid for piping according to piping direction.

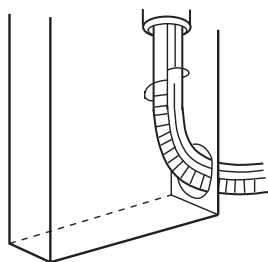

Insulation material

Copper tube

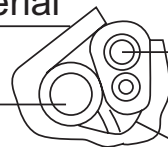

Drain hose

Connecting electric cable for indoor and outdoor unit

According to the piping method, connect the piping on indoor unit with union of connecting pipe.

Arrange the piping as per the wall hole and bind drain hose connecting electric cable and piping together with polyethylene tape.

Insert the bound piping connecting electric cable and drain hose through wall hole to connect with outdoor unit.

Arrangement of drain hose

- Drain hose shall be placed in under place.
- There should be a slope when arrange drain hose. Avoid up and down waves in drain hose.

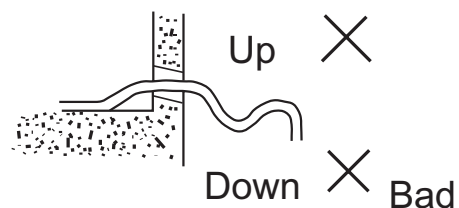
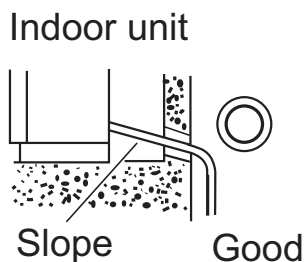

If humidity is high, drain pipe(especially in room and indoor unit) must be covered with insulation material.

■ Installation procedures

3. Piping connection of outdoor unit.

Connect the connecting pipe and inlet and outlet liquid pipe according to the piping method.

4.Purging method

Discharge the air out of the indoor unit and the refrigerant pipe by vacuumizing

(1) Fasten all the nuts of the indoor and outdoor pipes to make these parts out of leakage.

(2) Under the condition of the complete close of the indoor and outdoor valve center (both liquid and gas side),dismount the repair valve cap.Vacuumizing through the charge mouth of the repair valve.

(3) After vacuumizing fasten the repair valve,and dismount the cap of the big and small stop valve,then loosen the stop valve center completely and fasten the big and small stop valve.

5.Extra charging amount of the refrigerant

When piping is longer than 5 m, charge additional refrigerant specified in this list.

Pipe length	5m	10m	15m	20m	25m	30m
Refrigerant charge (g)	—	325	650	975	1300	1625

Note:

- Electric wiring must be done by qualified person.
- Use copper wire only, the parameter of connecting cable is H07RN-F 4G 0.75mm².
- The power cable should be over 5G2.5mm², the power cable and connecting cable are self-provided.
- The power supply connects from the outdoor unit.

Wiring of indoor unit

- Insert the cable from outside the wall hole where piping already exist.
- Pull it out from front.
- Loosen terminal screws and insert cable end fully into terminal block, then tighten it.
- Pull the cable gently to make sure it is tight.
- Replace cover after wiring.

Wiring of outdoor unit

- Insert the cable from inside the wall hole where piping already exists.
- Pull it out from front.
- Loose terminal screw and insert cable end fully into terminal block, then tighten it.
- Pull the cable gently to make sure it is tight.
- Replace cover after wiring.

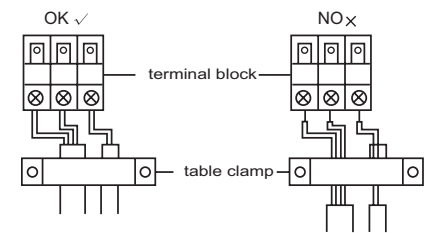

HPU-42CH03 HPU-48CJ03 HPU-48HJ03 HPU-42HH03 HPU-42HI03 HPU-48HK03

INDOOR UNIT TERMINAL BLOCK

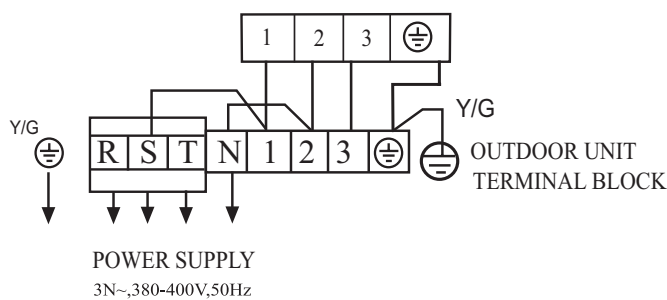

Note:

- When connecting indoor and outdoor wire, check the number on indoor and outdoor terminal blocks. Incorrect wiring may damage air conditioner's controller or cause operation failure.

Others

1. Pipe cutting and flaring

- Be sure to carry out deburring after pipe cutting with a pipe cutter.
- Insert flaring tool to make a flare.

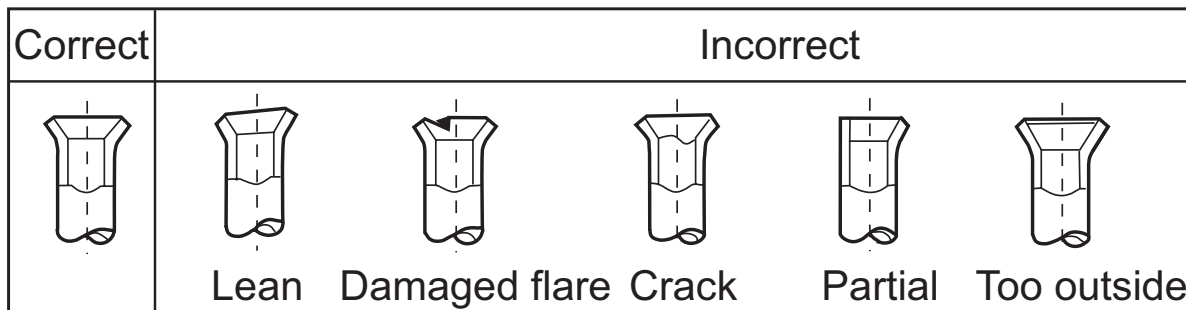

	Pipe dia.	Dimension A(mm)
Liquid pipe	∅ 9.52mm (3/8")	1.0 ~ 1.8
Gas pipe	∅ 19.05mm (3/4")	1.4 ~ 2.2

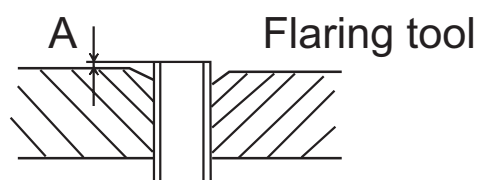

2. Installation inspection and test run:

Please operate unit according to this Manual.

Items to be checked during test run. Please made a "✓" in "□"

- Are there any gas leakage?
- How is insulation at piping connection carried out?
- Are electric wires of indoor and outdoor unit firmly inserted into terminal block?
- Is electric wiring of indoor and outdoor securely fixed?
- Is drainage securely carried out?
- Is earth line (grounding) securely connected?
- Is power supply voltage abided by the code?
- Is there any noise?
- Is control display normal?
- Is cooling operation normal?
- Is room temp. regulator normal?

