



USER'S GUIDE

V:1054-1008-09

TL909
Compact Television

CONTENTS

WARNINGS AND PRECATIONS	2
GENERAL PRODUCT INFORMATION	4
WHAT'S IN THE BOX	4
POWERING THE UNIT & REMOTE	5
AC/DC ADAPTER	5
DC CAR ADAPTER.....	5
RECHARGEABLE BATTERY	5
REMOTE BATTERY	5
CONNECTIONS	6
CONNECTING THE UNIT TO A TELEVISION SIGNAL	6
CONNECTING THE INCLUDED ANTENNA.....	6
AUTO SCANNING FOR CHANNELS.....	6
CONNECTIONS	7
CONNECTING THE UNIT TO DVD PLAYER	7
CONNECTING A SET-TOP BOX, GAMING CONSOLE, OR TELEVISION...	7
CONTROLS	8
CONTROL GLOSSARY	9
CONTROLS	10
CONTROL GLOSSARY	11
COMPANY INFORMATION	12
GREEN INITIATIVE	12
INTERNATIONAL SUPPORT	12
SERVICE INFORMATION.....	12

WARNINGS AND PRECATIONS

- **CAUTION:** TO PREVENT ELECTRIC SHOCK, MATCH WIDE BLADE OF PLUG TO WIDE SLOT, FULLY INSERT.
- **WARNING:** To prevent fire or shock hazards, do not expose this unit to rain or moisture.
- **CAUTION:** Use of controls or adjustments or performance of procedures other than those specified may result in hazardous radiation exposure.
- **WARNING:** Changes or modifications to this unit not expressly approved by the party responsible for compliance could void the user's authority to operate the equipment.
- **WARNING:** Do not place the unit on top of any soft, porous, or sensitive surfaces to avoid damaging the surface. Use a protective barrier between the unit and surface to protect the surface.
- **WARNING:** Use of this unit near fluorescent lighting may cause interference regarding use of the remote. If the unit is displaying erratic behavior move away from any fluorescent lighting, as it may be the cause.
- **CAUTION:** Danger of explosion if battery is incorrectly replaced. Replace only with the same or equivalent type.
- **PRÉCAUTION:** *Danger d'explosion si les piles sont remplacées de façon incorrect. Remplacer les piles seulement par le même type de pile ou l'équivalent.*
- **WARNING:** There is a danger of explosion if you attempt to charge standard Alkaline batteries in the unit. Only use rechargeable NiMH batteries.
- **WARNING:** The remote control's button cell battery contains mercury. Do not put in the trash, instead recycle or dispose of as hazardous waste
- **WARNING:** Lithium ion batteries, like all rechargeable batteries are recyclable and should be recycled or disposed of in normal household waste. Contact your local government for disposal or recycling practices in your area. They should never be incinerated since they might explode.

Do not mix old and new batteries.

Do not mix alkaline, standard (carbon-zinc), or rechargeable (ni-cad, ni-mh, etc) batteries.

No mezcle baterías viejas y nuevas.

No mezcle baterías alcalinas, estándar (carbono-zinc) o recargables (ni-cad, ni-mh, etc.).



The lightning flash with arrowhead symbol, within an equilateral triangle, is intended to alert the user to the presence of uninsulated "dangerous voltage" within the product's enclosure that may be of sufficient magnitude to constitute a risk of electric shock to persons.

CAUTION

RISK OF ELECTRIC SHOCK
DO NOT OPEN

WARNING: TO REDUCE THE RISK OF ELECTRIC SHOCK, DO NOT REMOVE COVER (OR BACK). NO USER-SERVICEABLE PARTS INSIDE. REFER SERVICING TO QUALIFIED SERVICE PERSONNEL.



The exclamation point within an equilateral triangle is intended to alert the user to the presence of important operating and maintenance (servicing) instructions in the literature accompanying the appliance.

IMPORTANT SAFETY INSTRUCTIONS

1. Read these Instructions.
2. Keep these Instructions.
3. Heed all Warnings.
4. Follow all instructions.
5. Do not use this apparatus near water.
6. Clean only with a dry cloth.
7. Do not block any ventilation openings. Install in accordance with the manufacturer's instructions.
8. Do not install near any heat sources such as radiators, heat registers, stoves, or other apparatus (including amplifiers) that produce heat.
9. Do not defeat the safety purpose of the polarized or grounding - type plug. A polarized plug has two blades with one wider than the other. A grounding type plug has two blades and a third grounding prong. The wide blade or the third prong are provided for your safety. When the provided plug does not fit into your outlet, consult an electrician for replacement of the obsolete outlet.
10. Protect the power cord from being walked on or pinched particularly at plugs, convenience receptacles, and the point where they exit from the apparatus.
11. Only use attachments/accessories specified by the manufacturer.
12. Use only with a cart, stand, tripod, bracket, or table specified by the manufacturer, or sold with the apparatus. When a cart is used, use caution when moving the cart/apparatus combination to avoid injury from tip-over.



13. Unplug this apparatus during lightning storms or when unused for long periods of time.
14. Refer all servicing to qualified service personnel. Servicing is required when the apparatus has been damaged in any way, such as power-supply cord or plug is damaged, liquid has been spilled or objects have fallen into the apparatus, the apparatus has been exposed to rain or moisture, does not operate normally, or has been dropped.

Additional Warnings

- The apparatus shall not be exposed to dripping or splashing and that no objects filled with liquids, such as vases, shall be placed on apparatus.
L'appareil ne doit pas être exposé aux écoulements ou aux éclaboussures et aucun objet ne contenant de liquide, tel qu'un vase, ne doit être placé sur l'objet.
- Main plug is used as disconnect device and it should remain readily operable during intended use. In order to disconnect the apparatus from the mains completely, the mains plug should be disconnected from the mains socket outlet completely.
La prise du secteur ne doit pas être obstruée ou doit être facilement accessible pendant son utilisation. Pour être complètement déconnecté de l'alimentation d'entrée, la prise doit être débranchée du secteur.
- Battery shall not be exposed to excessive heat such as sunshine, fire or the like.
Les piles ne doivent pas être exposées à de forte chaleur, tel qu'à la lumière du soleil, au feu ou autres choses de semblable.
- Caution marking is located at the rear of apparatus.
Les précautions d'emploi sont inscrites en bas de l'appareil.
- The marking information is located at the rear of apparatus.
Les marquages sont inscrits en bas de l'appareil.

FCC Warnings

NOTE: This equipment has been tested and found to comply with the limits for a Class B digital device, pursuant to Part 15 of the FCC Rules. These limits are designed to provide reasonable protection against harmful interference in a residential installation. This equipment generates, uses, and can radiate radio frequency energy and, if not installed and used in accordance with the instructions, may cause harmful interference to radio communications. However, there is no guarantee that interference will not occur in a particular installation. If this equipment does cause harmful interference to radio or television reception, which can be determined by turning the equipment off and on, the user is encouraged to try to correct the interference by one or more of the following measures:

- Reorient or relocate the receiving antenna.
- Increase the separation between the equipment and receiver.
- Connect the equipment into an outlet on a circuit different from that to which the receiver is connected.
- Consult the dealer or an experienced radio/TV technician for help.

GENERAL PRODUCT INFORMATION

WHAT'S IN THE BOX

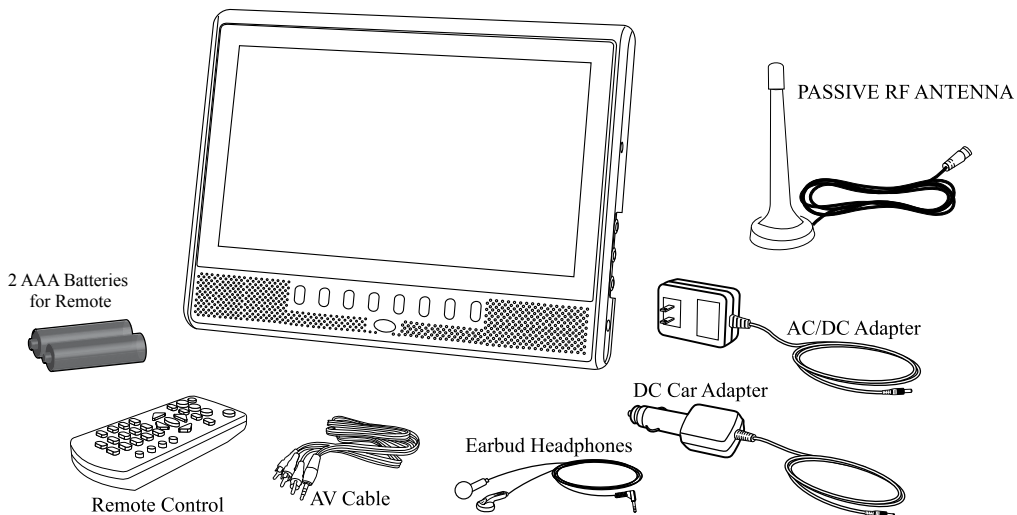

FEATURES

- 9" Color LCD TV
- Digital and Analog Tuner
- Cable Signal Receive Function
- Auto-Search TV Channel and Electronic Program Guide
- Supports up to 720p
- Aspect Select: 4:3/16:9
- Multi-Language OSD: On-Screen Display in English, French & Spanish
- Digital Volume Control
- Adjustable Sleep Timer
- Thin Profile, Portable
- A/V Input
- Stereo Audio Output
- Stereo Headphone Jack
- Cable Connection
- Built-In Speakers
- Full-Feature Remote Control
- Stereo Left/Right Audio Channel Balance Adjustment
- AC/DC-Powered: Rechargeable Battery built in
- AC: AC/DC Adaptor, UL/CUL Listed
- DC: 12V DC Car Adaptor
- Built-In Rechargeable Battery

AC/DC ADAPTER

The unit can be powered by connecting the included AC/DC adapter to the DC Power Input and a standard AC outlet.

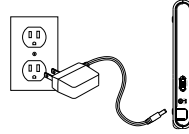
**DC CAR ADAPTER**

The unit can be powered by connected the included DC Car Adapter to the DC Power Input on the unit and a car lighter or DC power source in a car.

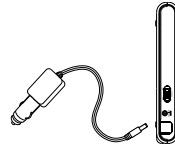
**RECHARGEABLE BATTERY**

The pre-installed rechargeable battery can be used to power the unit when no other power source is available.

The rechargeable battery will recharge when the unit is connected to an AC or DC power source, such as a standard AC outlet or a DC power source in a car.

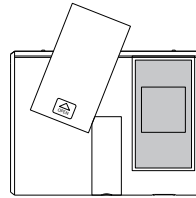
**REMOTE BATTERY**

The Remote requires 2 AAA batteries, included.

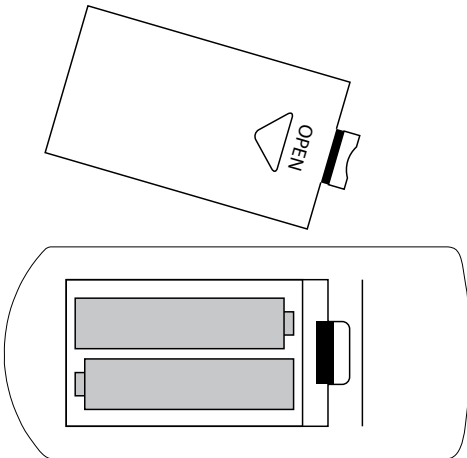

CONNECTIONS

CONNECTING THE UNIT TO A TELEVISION SIGNAL

1. Connect a coaxial television cable to the **RF Input** on the unit.
2. Connect the other end of the coaxial television cable to the Antenna Output on a DVD Player, Gaming Console, Television, Set-Top Box, or an incoming Analog Cable Signal.
3. Press the **TV/AV Button**, highlight “TV”, and press the **Enter Button**.
4. The incoming analog television signal will now play on the unit.

Connecting to a DVD Player, Gaming Console, Television, or Set-top Box

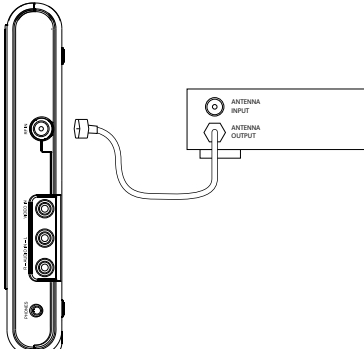

Connecting to an incoming Analog Cable Signal.

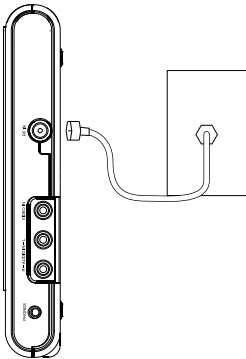

CONNECTING THE INCLUDED ANTENNA

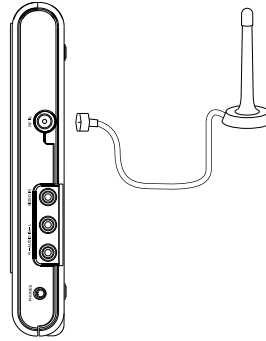

AUTO SCANNING FOR CHANNELS

1. Press the **TV/AV Button**, highlight “TV”, and press the **Enter Button**.
2. Press the **Auto/Enter Button** once to bring up the auto scan menu.
3. Press the **Auto/Enter Button** twice to begin auto scanning for available channels.

CONNECTING THE UNIT TO DVD PLAYER

1. Connect an RCA Stereo Audio/Composite Video Cable to the **R/L Stereo Audio Inputs** and the **Composite Video Input** on the unit.

2. Connect the other end of the RCA Cable to the Stereo Audio Outputs and Composite Video Output on a DVD Player.

3. Press the **TV/AV Button**, highlight “AV In”, and press the **Enter Button**.

4. Content from the DVD Player will now play on the unit.

CONNECTING A SET-TOP BOX, GAMING CONSOLE, OR TELEVISION

Any of these devices can be connected to the unit in the same way that the DVD player is connected. Follow the instructions for Connecting the Unit to a DVD Player to connect one of the devices listed above.

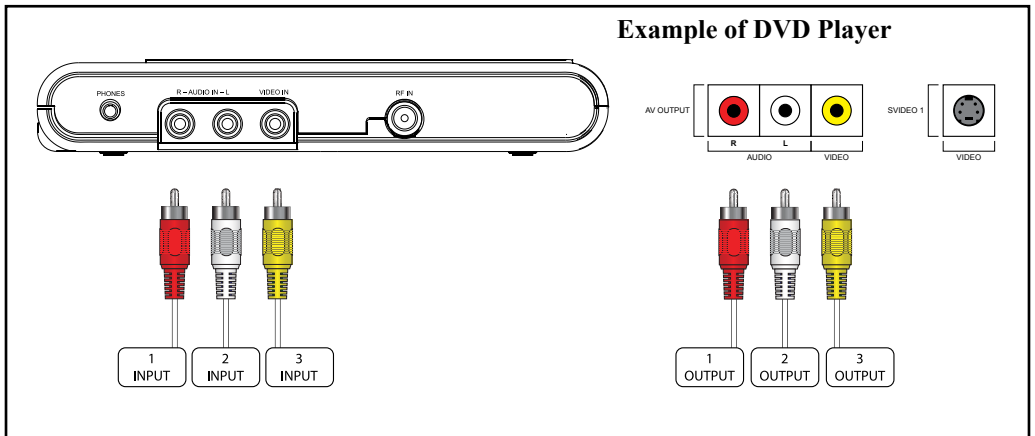

CONTROLS

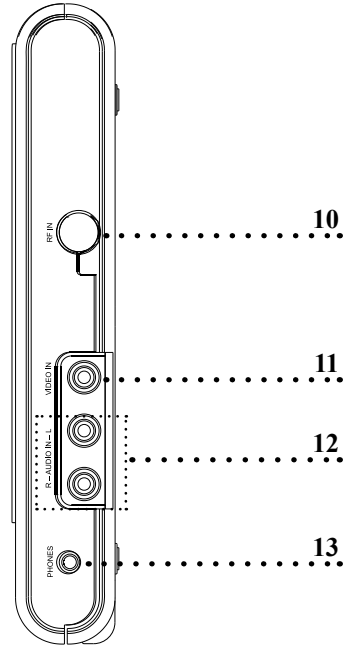
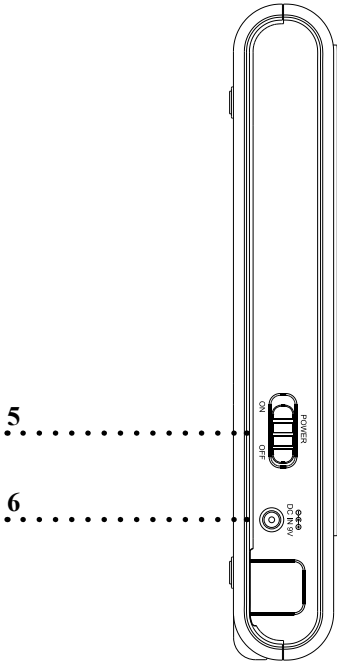
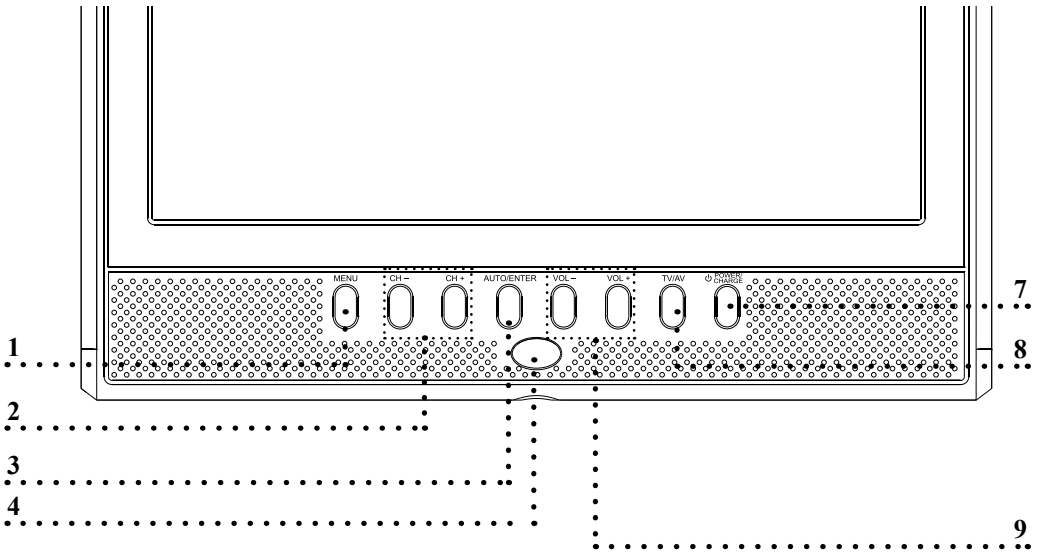

01. Menu Button

Press the Menu Button to access the unit's setup menu.

02. Channel +/- Buttons

Press the Channel +/- Buttons to cycle through the available channels.

03. Auto/Enter Button

Press to access the Auto Scan menu. Press a second time to begin auto scanning for channels.

Press the Auto/Enter Button to make a selection.

04. Infrared Receiver for Remote**05. Power Switch**

Adjust the Power Switch to turn the unit off or on.

06. DC Power Input

Use the DC Power Input to connect the unit to a power source.

07. Power/Charge Indicator

Power On: ORANGE

Power Off and Plugged In: RED

Power Off and Not Plugged In: OFF

08. TV/AV Button

Press the TV/AV Button to switch between the TV Antenna Input and the AV Inputs.

09. Volume Buttons**10. RF Input**

Use the RF Input to receive over the air television reception.

Use the RF Input to connect an analog cable television source.

11. Composite Video Input

Use the Composite Video Input to input video to the unit from a DVD Player or other video source.

12. R/L Stereo Audio Inputs

Use the R/L Stereo Audio Inputs to input audio to the unit from a DVD Player or other audio source.

13. Headphone Jack

Use the Headphone Jack to connect a set of earbuds or headphones to the unit.

CONTROLS

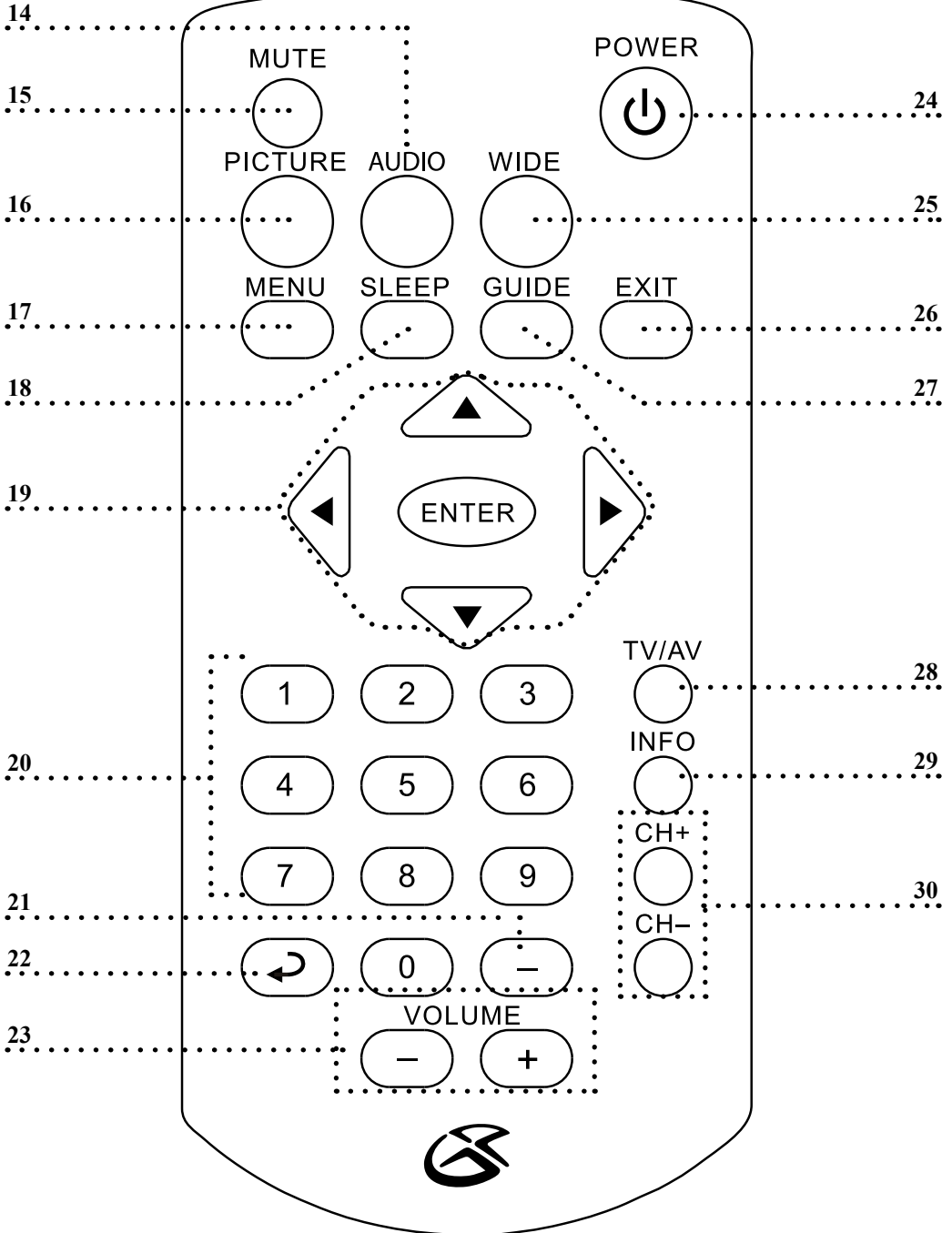

14. Audio Button

Press the Audio Button to adjust the audio output language.

15. Mute Button

Press the Mute Button to reduce the volume of the unit completely.

16. Picture Button

Press the Picture Button to adjust the *Picture Mode*.

17. Menu Button

Press the Menu Button to access the unit's setup menu.

18. Sleep Button

Press the Sleep Button to set the sleep timer on the unit. (*Off, 5, 10 15, 30, 60, 90, or 120 minutes*)

19. Directional Buttons

Press the Directional Buttons to navigate the unit's menus.

Enter Button

Press the Enter Button to make selections on the unit's menus.

20. Number Keypad**21. - Button**

Use the - Button to input specific television channels.

22. Back Button

Press the Back Button to return to the previous channel.

23. Volume Buttons

Press the Volume Buttons to adjust the volume of audio output from the unit.

24. Power Button

Press the Power Button to turn the unit off and on.

25. Wide Button

Press the Wide Button to adjust the unit's aspect ratio.

26. Exit Button

Press the Exit Button to exit the unit's menus.

27. Guide Button

Press the Guide Button to access the guide on an incoming television signal.

28. TV/AV

Press the TV/AV Button to switch between the TV Antenna Input and the AV Inputs.

29. Info Button

Press the Info Button to view the info on the current channel from an incoming television signal.

30. Channel +/- Buttons

Press the Channel +/- Buttons to cycle through the available channels.

COMPANY INFORMATION

GREEN INITIATIVE

Environmental Commitment to ‘Protect for Today and Sustain for Tomorrow’

2009 marks the official launch of DPI, Inc.’s corporate campaign for a greener and cleaner world. DPI and its four brands, iLive, WeatherX, Capri, and GPX, are building upon environmental initiatives introduced at all of their facilities to help formulate and sustain significant and important conservation efforts within its manufacturing and marketing communities. In addition to targeting and selecting energy efficient product features, and structuring ‘green office’ procedures, other initial program efforts include:

- Reduction of all packaging sizes
- Recyclable plastics for clamshell packages, with a plan to eventually replace plastic with recyclable paper
- Recycled fiber board in place of the polyfoam in packing boxes
- Recycled plastics in place of the virgin material in product construction

INTERNATIONAL SUPPORT

To download this User’s Guide in English, Spanish, or French, visit the support section at www.gpx.com.

Para transferir esta guía de usuario en inglés, español, o francés, visite la sección de la ayuda en www.gpx.com.

Pour télécharger ce guide de l’utilisateur en anglais, espagnol, ou français, visitez la section de soutien chez www.gpx.com.

SERVICE INFORMATION

Address: 2116 Carr Street, St. Louis MO, 63106

Phone: 1-314-621-2881

Fax: 1-314-588-1805

Email: prodinfo@gpx.com

Parts Email: partsinfo@dpi-global.com

Website: www.gpx.com