

MOXA EtherDevice Switch

EDS-308/305 Hardware Installation Guide

Fourth Edition, September 2004



Moxa Networking Co., Ltd.

Tel: +886-2-8919-1230

Fax: +886-2-8919-1231

www.moxa.com

support@moxanet.tw (Worldwide)

support@moxa.com (The Americas)

P/N: 18020030003

Overview

The MOXA EtherDevice™ Smart Switches, EDS-308/305 Series, are 8- and 5- port Ethernet Switches that provide an economical solution for your Ethernet connections, and the built-in smart alarm function helps system maintainers monitor the health of your Ethernet network.

These products have a wide operating temperature range, from -40 to 75°C, and are designed to withstand a high degree of vibration and shock. The rugged hardware design makes EDS-308/305 Series perfect for ensuring that your Ethernet equipment can withstand critical industrial applications, such as in hazardous locations (Class 1 Division 2/ Zone 2), and complies with FCC, TÜV, UL, and CE Standards.

NOTE *Throughout this Hardware Installation Guide, we use **EDS** as an abbreviation for MOXA EtherDevice Switch:*

EDS = MOXA EtherDevice Switch

Package Checklist

MOXA EtherDevice Switch is shipped with the following items. If any of these items is missing or damaged, please contact your customer service representative for assistance.

- MOXA EtherDevice™ Switch
- Hardware Installation Guide
- MOXA Product Warranty booklet
- Protective caps for unused ports

Features

High Performance Network Switching Technology

- 10/100BaseT(X) (RJ45), 100BaseFX (SC type, Multi/Single mode)
- IEEE 802.3/802.3u/802.3x
- Store and Forward switching process type, 1024 address entries
- 10/100M, Full/Half-Duplex, MDI/MDIX auto-sensing

Industrial Grade Reliability

- Power failure, port break alarm by relay output
- Redundant dual DC power inputs

Rugged Design

- Operating temperature ranges from 0 to 60°C, or extended operating temperature from -40 to 75°C for (-T) models
- IP 30, rugged high-strength case
- DIN-Rail or panel mounting ability

Panel Layout of EDS-305 Series

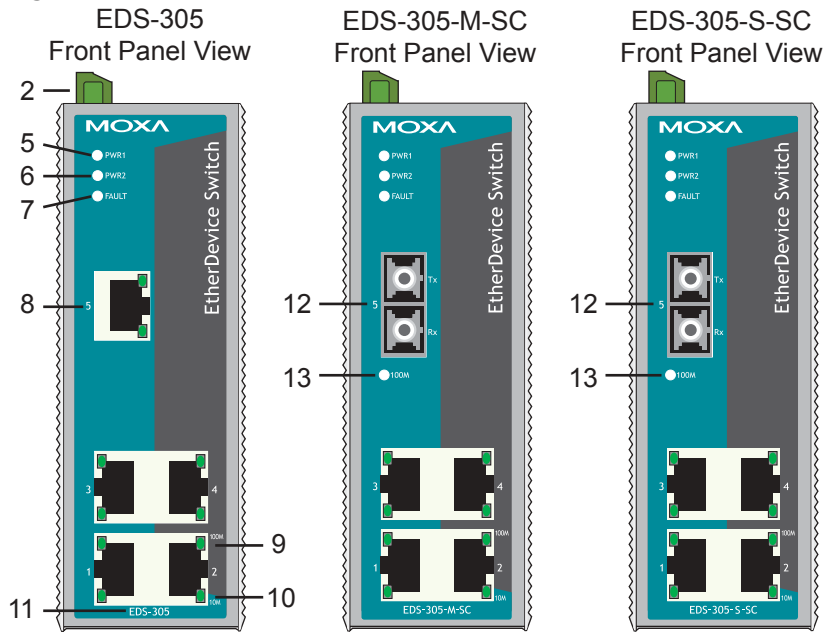

Top Panel View

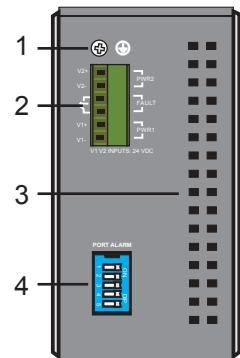

Rear Panel View

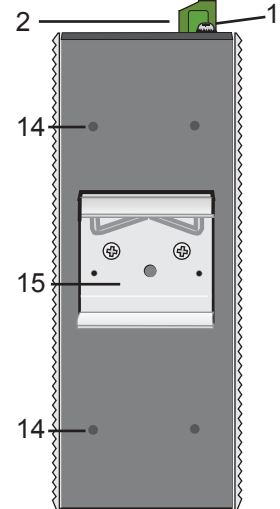

1. Grounding screw
2. Terminal block for power input P1/P2 and relay output
3. Heat dissipation orifices
4. DIP switches
5. Power input P1 LED
6. Power input P2 LED
7. Fault LED
8. 10/100BaseT(X) Port
9. TP port's 100 Mbps LED
10. TP port's 10 Mbps LED
11. Model Name
12. 100BaseFX Port
13. FX port's 100 Mbps LED
14. Screw hole for wall mounting kit
15. DIN-Rail Kit

Panel Layout of EDS-308 Series

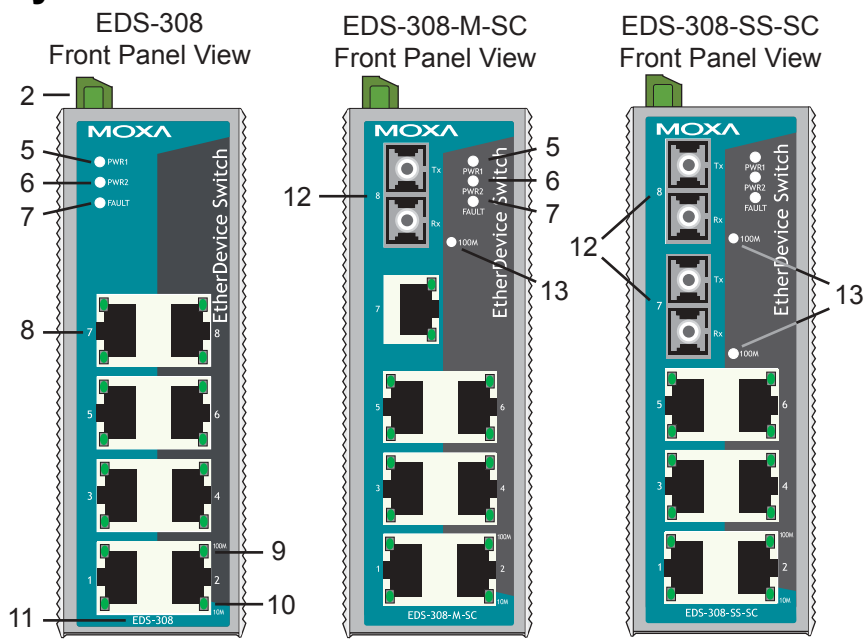

Top Panel View

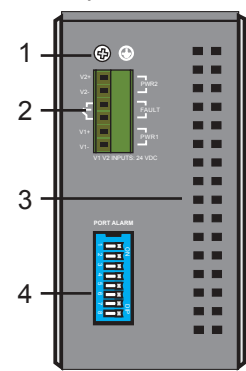

Rear Panel View

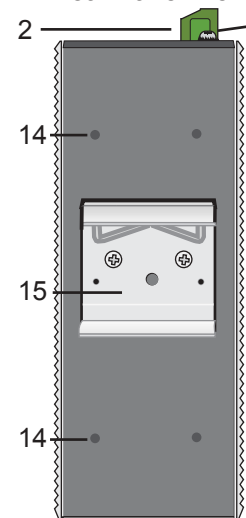

NOTE: The appearance of EDS-308-S-SC is identical to EDS-308-M-SC, and the appearance of EDS-308-MM-SC is identical to EDS-308-SS-SC.

1. Grounding screw
2. Terminal block for power input P1/P2 and relay output
3. Heat dissipation orifices
4. DIP switches
5. Power input P1 LED
6. Power input P2 LED
7. Fault LED
8. 10/100BaseT(X) Port
9. TP port's 100 Mbps LED
10. TP port's 10 Mbps LED
11. Model Name
12. 100BaseFX Port
13. FX port's 100 Mbps LED
14. Screw hole for wall mounting kit
15. DIN-Rail Kit

Mounting Dimensions (unit = mm)

Side View

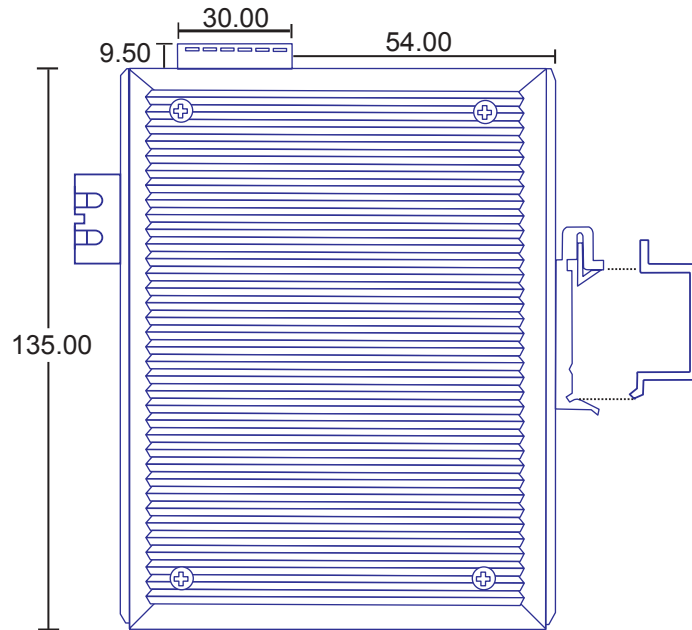

Front View

Back View

Panel Mount Kit

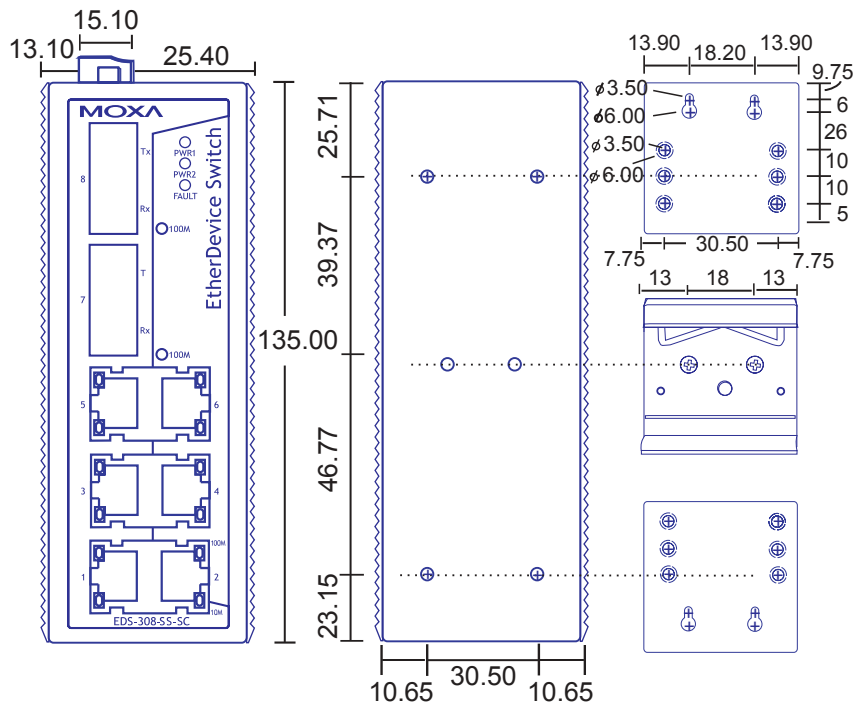

DIN-Rail Mounting

The aluminum DIN-Rail attachment plate should already be fixed to the back panel of EDS when you take it out of the box. If you need to reattach the DIN-Rail attachment plate to EDS, make sure the stiff metal spring is situated towards the top, as shown in the figures below.

STEP 1:

Insert the top of the DIN-Rail into the slot just below the stiff metal spring.

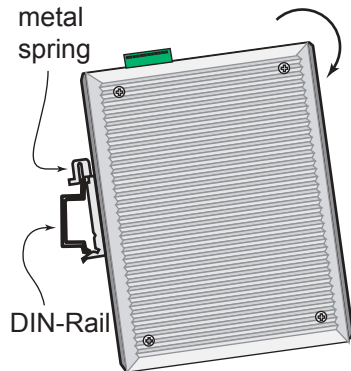

STEP 2:

The DIN-Rail attachment unit will snap into place as shown below.

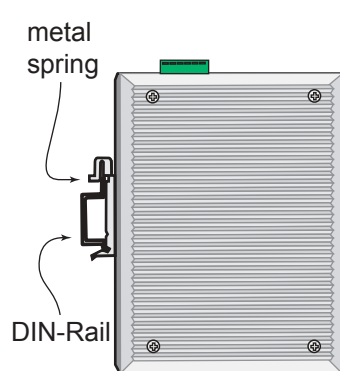

To remove MOXA EtherDevice Switch from the DIN-Rail, simply reverse Steps 1 and 2 above.

Wall Mounting (OPTIONAL)

For some applications, you will find it convenient to mount MOXA EtherDevice Switch on the wall, as illustrated below.

STEP 1:

Remove the aluminum DIN-Rail attachment plate from MOXA EtherDevice Switch's rear panel, and then attach the wall mount plates, as shown in the diagram below.

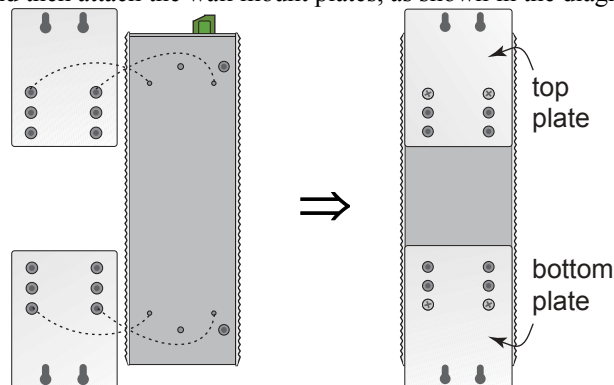

STEP 2:

Mounting MOXA EtherDevice Switch on the wall requires 4 screws. Use the Switch, with wall mount plates attached, as a guide to mark the correct locations of the 4 screws. The heads of the screws should be less than 6.0 mm in diameter, and the shafts should be less than 3.5 mm in diameter, as shown in the figure at the right.

NOTE Before tightening screws into the wall, make sure the screw head and shank size are suitable by inserting the screw into one of the keyhole-shaped apertures of the Wall Mounting Plates.

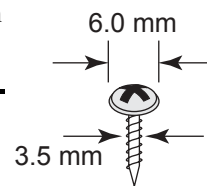

Do not screw the screws in all the way—leave about 2 mm to allow room for sliding the wall mount panel between the wall and the screws.

STEP 3: Once the screws are fixed in the wall, insert the four screw heads through the large parts of the keyhole-shaped apertures, and then slide MOXA EtherDevice Switch downwards, as indicated below. Tighten the four screws for added stability.

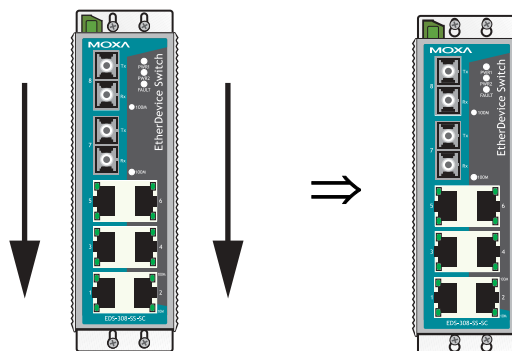

Wiring Requirements

WARNING



Do not disconnect modules or wires unless the power supply has been switched off or the area is known to be non-hazardous.

The devices may only be connected to the supply voltage shown on the type plate.

The devices are designed for operation with a safety extra-low voltage. Thus, they may only be connected to the supply voltage connections and to the signal contact with the safety extra-low voltages (SELV) in compliance with IEC950/ EN60950/ VDE0805.

WARNING



Substitution of components may impair suitability for Class I, Division 2 and Zone 2.

These devices must be supplied by a SELV source as defined in the Low Voltage Directive 73/23/EEC and 93/68/EEC.

WARNING



This equipment has been evaluated as EEx nC IIC T4 equipment under DEMKO Certificate No. 03 ATEX 0324537U. Each module is marked  II 3G and is suitable for use in Zone 2 Explosive Atmospheres. The device must be installed in a minimum IP 54 enclosure as defined in IEC 60529 and EN 60529.

ATTENTION



This unit is a built-in type. When the unit is installed in another piece of equipment, the equipment enclosing the unit must comply with fire enclosure regulation IEC 60950/EN60950 (or similar regulation).

ATTENTION



Safety First!

Be sure to disconnect the power cord before installing and/or wiring your MOXA EtherDevice Switch.

Calculate the maximum possible current in each power wire and common wire. Observe all electrical codes dictating the maximum current allowable for each wire size.

If the current goes above the maximum ratings, the wiring could overheat, causing serious damage to your equipment.

You should also pay attention to the following items:

- Use separate paths to route wiring for power and devices. If power wiring and device wiring paths must cross, make sure the wires are perpendicular at the intersection point.
- NOTE: Do not run signal or communications wiring and power wiring in the same wire conduit. To avoid interference, wires with different signal characteristics should be routed separately.
- You can use the type of signal transmitted through a wire to determine which wires should be kept separate. The rule of thumb is that wiring that shares similar electrical characteristics can be bundled together.
- Keep input wiring and output wiring separated.
- It is strongly advised that you label wiring to all devices in the system when necessary.

Grounding MOXA EtherDevice Switch

Grounding and wire routing help limit the effects of noise due to electromagnetic interference (EMI). Run the ground connection from the ground screw to the grounding surface prior to connecting devices.

ATTENTION This product is intended to be mounted to a well-grounded mounting surface, such as a metal panel.



Wiring the Alarm Contact

The Alarm Contact consists of the two middle contacts of the terminal block on EDS's top panel. You may refer to the next section for detailed instructions on how to connect the wires to the terminal block connector, and how to attach the terminal block connector to the terminal block receptor.

In this section, we explain the meaning of the two contacts used to connect the Alarm Contact.

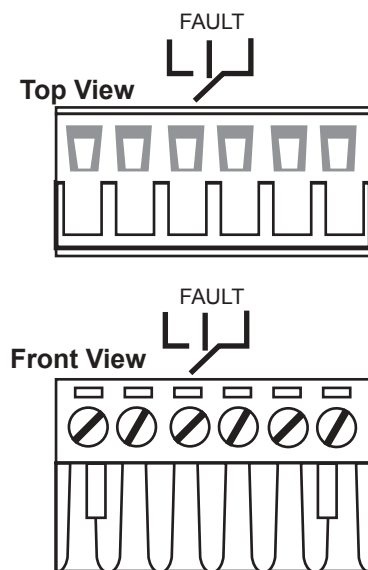

FAULT: The two middle contacts of the 6-contact terminal block connector are used to detect both power faults and port faults. The two wires attached to the Fault contacts form an open circuit when:

1. EDS has lost power from one of the DC power inputs.
OR
2. One of the ports for which the corresponding PORT ALARM DIP Switch is set to ON is not properly connected.

If neither of these two conditions is satisfied, the Fault circuit will be closed.

Wiring the Redundant Power Inputs

The top two contacts and the bottom two contacts of the 6-contact terminal block connector on EDS's top panel are used for EDS's two DC inputs. Top and front views of one of the terminal block connectors are shown here.

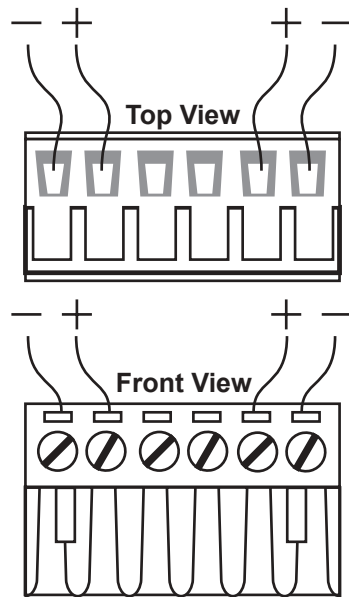

STEP 1: Insert the negative/positive DC wires into the V-/V+ terminals.

STEP 2: To keep the DC wires from pulling loose, use a small flat-blade screwdriver to tighten the wire-clamp screws on the front of the terminal block connector.

STEP 3: Insert the plastic terminal block connector prongs into the terminal block receptor, which is located on EDS's top panel.

ATTENTION Before connecting EDS to the DC power inputs, make sure the DC power source voltage is stable.



Communication Connections

EDS-308 models have 6, 7, or 8 10/100BaseT(X) Ethernet ports, and 2, 1, or 0 (zero) 100BaseFX (SC-type connector) fiber ports. EDS-305 models have 4 or 5 10/100BaseT(X) Ethernet ports, and 1 or 0 (zero) 100 BaseFX (SC-type connector) fiber ports.

10/100BaseT(X) Ethernet Port Connection

The 10/100BaseT(X) ports located on EDS's front panel are used to connect to Ethernet-enabled devices.

Below we show pinouts for both MDI (NIC-type) ports and MDI-X (HUB/Switch-type) ports, and also show cable wiring diagrams for straight-through and cross-over Ethernet cables.

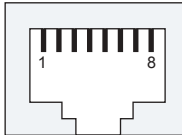
MDI Port Pinouts		MDI-X Port Pinouts		8-pin RJ45
Pin	Signal	Pin	Signal	
1	Tx+	1	Rx+	
2	Tx-	2	Rx-	
3	Rx+	3	Tx+	
6	Rx-	6	Tx-	

RJ45 (8-pin) to RJ45 (8-pin) Straight-Through Cable Wiring

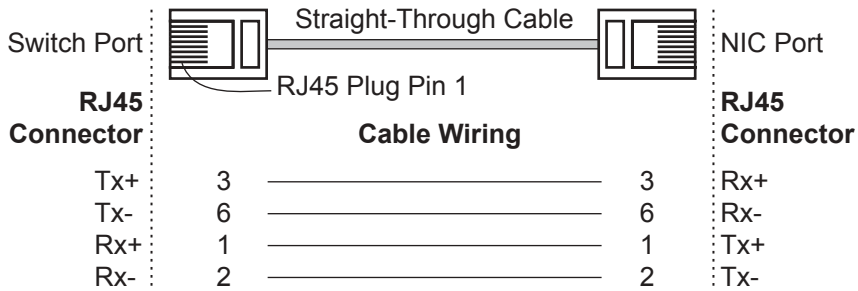

RJ45 (8-pin) to RJ45 (8-pin) Cross-Over Cable Wiring

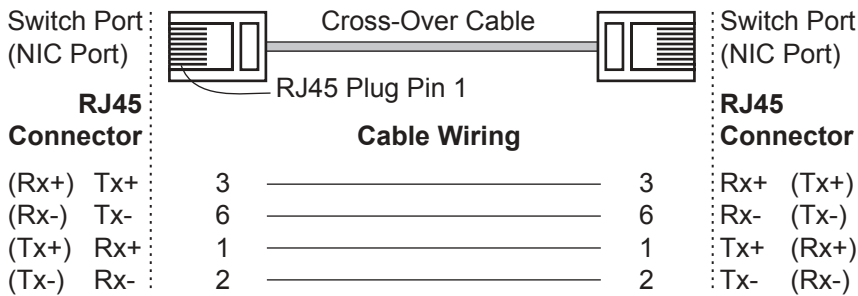

100BaseFX Ethernet Port Connection

The concept behind the SC port and cable is quite straightforward. Suppose you are connecting devices I and II. Contrary to electrical signals, optical signals do not require a circuit in order to transmit data. Consequently, one of the optical lines is used to transmit data from device I to device II, and the other optical line is used to transmit data from device II to device I, for full-duplex transmission.

All you need to remember is to connect the Tx (transmit) port of device I to the Rx (receive) port of device II, and the Rx (receive) port of device I to the Tx (transmit) port of device II. If you make your own cable, we suggest labeling the two sides of the same line with the same letter (A-to-A and B-to-B, as shown below, or A1-to-A2 and B1-to-B2).

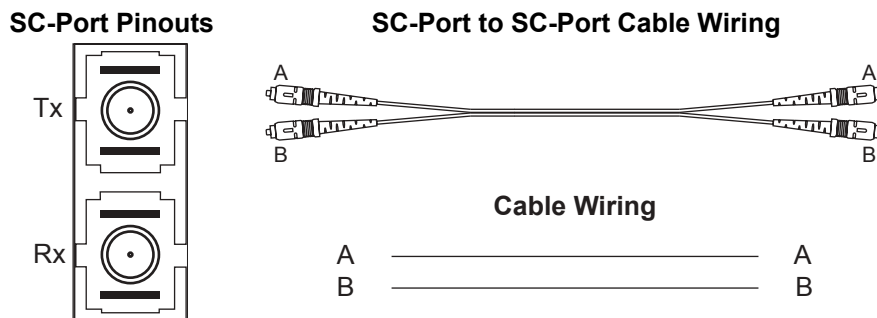

ATTENTION This is a Class 1 Laser/LED product. To avoid causing serious damage to your eyes, do not stare directly into the Laser Beam.



Redundant Power Inputs

Both power inputs can be connected simultaneously to live DC power sources. If one power source fails, the other live source acts as a backup, and automatically supplies all of MOXA EtherDevice Switch's power needs.

Alarm Contact

MOXA EtherDevice Switch has one Alarm Contact located on the top panel. For detailed instructions on how to connect the Alarm Contact power wires to the two middle contacts of the 6-contact terminal block connector, see the Wiring the Alarm Contact section above. A typical scenario would be to connect the Fault circuit to a warning light located in the control room. The light can be set up to switch on when a fault is detected.

The Alarm Contact has two terminals that form a Fault circuit for connecting to an alarm system. The two wires attached to the Fault contacts form an open circuit when (1) EDS has lost power from one of the DC power inputs, or (2) one of the ports for which the corresponding PORT ALARM DIP Switch is set to ON is not properly connected.

If neither of these two conditions occurs, the Fault circuit will be closed.

DIP Switch Settings

EDS-308 Series DIP Switches

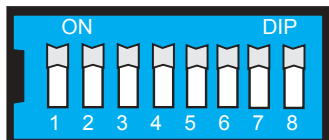

EDS-305 Series DIP Switches

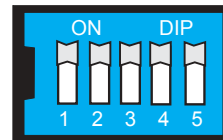

ON: Enables the corresponding PORT Alarm. If the port's link fails, the relay will form an open circuit and the fault LED will light up.

Off: Disables the corresponding PORT Alarm. The relay will form a closed circuit and the Fault LED will never light up.

LED Indicators

The front panel of MOXA EtherDevice Switch contains several LED indicators. The function of each LED is described in the table below.

LED	Color	State	Description
P1	AMBER	On	Power is being supplied to power input P1
		Off	Power is not being supplied to power input P1
P2	AMBER	On	Power is being supplied to power input P2
		Off	Power is not being supplied to power input P2
Fault	RED	On	When the corresponding PORT alarm is enabled, and the port's link is inactive.
		Off	When the corresponding PORT alarm is enabled and the port's link is active, or when the corresponding PORT alarm is disabled.
10M	GREEN	On	TP port's 10 Mbps link is active
		Blinking	Data is being transmitted at 10 Mbps
		Off	TP Port's 10 Mbps link is inactive
100M (TP)	GREEN	On	TP port's 100 Mbps link is active
		Blinking	Data is being transmitted at 100 Mbps
		Off	100BaseTX Port's link is inactive
100M (FX)	GREEN	On	FX port's 100 Mbps is active
		Blinking	Data is being transmitted at 100 Mbps
		Off	100BaseFX port is inactive

Auto MDI/MDI-X Connection

The Auto MDI/MDI-X function allows users to connect MOXA EtherDevice Switch's 10/100BaseTX ports to any kind of Ethernet device, without needing to pay attention to the type of Ethernet cable being used for the connection. This means that you can use either a straight-through cable or cross-over cable to connect EDS to Ethernet devices.

Fiber Ports

MOXA EtherDevice Switch's fiber switched ports operate at a fixed 100 Mbps speed and full-duplex mode to provide the best performance. The fiber ports are factory-built as either a multi-mode or single-mode SC connector. Consequently, you should use fiber cables that have SC connectors at both ends. When plugging the connector into the port, make sure the slider guide is positioned to the right side so that it fits snugly into the port.

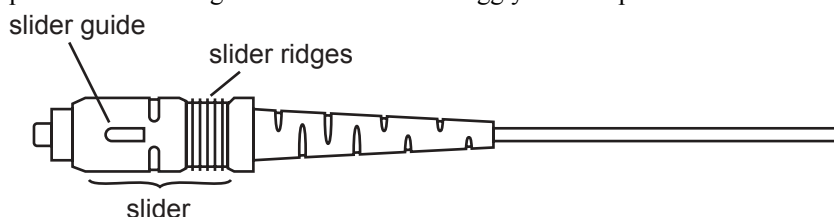

The 100 Mbps fiber ports are switched ports, and perform as a domain, providing a high bandwidth backbone connection that supports long fiber cable distances (up to 2 km for multi-mode, and 15 km for single-mode) for installation versatility.

Dual Speed Functionality and Switching

MOXA EtherDevice Switch's 10/100 Mbps switched RJ45 port auto negotiates with the connected device for the fastest data transmission rate supported by both devices. All models of MOXA EtherDevice Switch are plug-and-play devices, so that software configuration is not required at installation, or during maintenance. The half/full duplex mode for the switched RJ45 ports is user dependent and changes (by auto-negotiation) to full or half duplex, depending on which transmission speed is supported by the attached device.

Switching, Filtering, and Forwarding

Each time a packet arrives at one of the switched ports, a decision is made to either filter or forward the packet. Packets with source and destination addresses belonging to the same port segment will be filtered, constraining those packets to one port, and relieving the rest of the network from the need to process them. A packet with destination address on another port segment will be forwarded to the appropriate port, and will not be sent to the other ports where it is not needed. Packets that are used in maintaining the operation of the network (such as the occasional multi-cast packet) are forwarded to all ports.

MOXA EtherDevice Switch operates in the store-and-forward switching mode, which eliminates bad packets and enables peak performance to be achieved when there is heavy traffic on the network.

Switching and Address Learning

MOXA EtherDevice Switch has an address table that can hold up to 1K node addresses, which makes it suitable for use with large networks. The address tables are self-learning, so that as nodes are added or removed, or moved from one segment to another, MOXA EtherDevice Switch

automatically keeps up with new node locations. An address-aging algorithm causes the least-used addresses to be deleted in favor of newer, more frequently used addresses. To reset the address buffer, power down the unit and then power it back up.

Auto-Negotiation and Speed Sensing

All of MOXA EtherDevice Switch's RJ45 Ethernet ports independently support auto-negotiation for speeds in the 10BaseT and 100BaseTX modes, with operation according to the IEEE 802.3u standard. This means that some nodes could be operating at 10 Mbps, while at the same time, other nodes are operating at 100 Mbps.

Auto-negotiation takes place when an RJ45 cable connection is made, and then each time a LINK is enabled. MOXA EtherDevice Switch advertises its capability for using either 10 Mbps or 100 Mbps transmission speeds, with the device at the other end of the cable expected to similarly advertise. Depending on what type of device is connected, this will result in agreement to operate at a speed of either 10 Mbps or 100 Mbps.

If a MOXA EtherDevice Switch RJ45 Ethernet port is connected to a non-negotiating device, it will default to 10 Mbps speed and half-duplex mode, as required by the IEEE 802.3u standard.

Specifications

Technology

Standards	IEEE802.3, 802.3u, 802.3x
Forward and Filtering Rate	148810 pps
Packet Buffer Memory	256 KB
Processing Type	Store and For-ward, with IEEE802.3x full duplex, non-blocking flow control
Address Table Size	1K uni-cast addresses
Latency	Less than 5 μ s
Interface	
RJ45 Ports	10/100BaseT(X) auto negotiation speed, F/H duplex mode, and auto MDI/MDI-X connection
Fiber Ports	100BaseFX ports (SC connector)
LED Indicators	Power, Faults, ACT, LNK, 10/100
DIP Switch	Port break alarm mask
Alarm Contact	One relay output with current carrying capacity of 1A @ 24 VDC

Optical Fiber

Distance	Single mode fiber for 15 km, Multi mode fiber for 2 km
Wavelength	1310 nm
Min. TX Output	-15 dBm (Single), -20 dBm (Multi)
Max. TX Output	-6 dBm (Single), -14 dBm (Multi)
Sensitivity	-36 to -32 dBm (Single), -34 to -30 dBm (Multi)

Power

Input Voltage	12 to 48 VDC, redundant inputs
Input Current @ 24VDC	0.25 A (EDS-305, EDS-305-M, EDS-305-S, EDS-308) 0.35 A (EDS-308-M, EDS-308-S, EDS-308-MM, EDS-308-SS)
Connection	Removable Terminal Block
Overload Current Protection	1.1 A (EDS-305, EDS-305-M, EDS-305-S, EDS-308) 1.6 A (EDS-308-M, EDS-308-S, EDS-308-MM, EDS-308-SS)
Reverse Polarity Protection	Present

Mechanical

Casing	IP30 protection, aluminum case
Dimensions	53.6 x 135 x 105 mm (W x H x D)
Weight	0.63 kg
Installation	DIN-Rail, Wall Mounting

Environmental

Operating Temperature	0 to 60oC (32 to 140oF) -40 to 75oC (-40 to 167oF), for “-T” models
Storage Temperature	-40 to 85oC (-40 to 185oF)
Ambient Relative Humidity	5 to 95% (non-condensing)

Regulatory Approvals

Safety	UL60950, UL 508, CSA C22.2 No. 60950, EN60950
Hazardous Location	UL/cUL Class I, Division 2, Groups A, B, C and D ATEX Class I, Zone 2, EEx nC IIC
EMI	FCC Part 15, CISPR (EN55022) class A
EMS	EN61000-4-2 (ESD), Level 3 EN61000-4-3 (RS), Level 3 EN61000-4-4 (EFT), Level 3 EN61000-4-5 (Surge), Level 3 EN61000-4-6 (CS), Level 3
Shock	IEC 60068-2-27
Free Fall	IEC 60068-2-32
Vibration	IEC 60068-2-6

WARRANTY

5 years

MOXA Internet Services

Customer satisfaction is our number one concern, and to ensure that customers receive the full benefit of our products, Moxa has set up on-line support services to provide technical support, driver updates, product information, and user's manual updates.

E-mail for technical support:

support@moxanet.com (Worldwide)

support@moxa.com (The Americas)

Website for up to date product information:

www.moxa.com

Revision History

Document Edition	Revision Date	Revision Details
2nd	April 17, 2004	<ol style="list-style-type: none">1. Updated the edition of this manual on the title page.2. Changed the Moxa logo on the title page.3. Added several "Attention" messages.4. Added one product feature: "Operating temperature ranges from 0 to 60°C, or extended operating temperature from -40 to 75°C for (-T) models."
3rd	July 1, 2004	<ol style="list-style-type: none">1. Revised 100BaseFX for fiber optic port
4th	Sept. 25, 2004	<ol style="list-style-type: none">1. Updated all figures.2. Edited content.3. Updated operating temp. spec.