



USER'S MANUAL
MANUEL DE L'UTILISATEUR
MANUAL DEL USUARIO

CW39T8RW

Contents

Caution	2
Safety Information	3

Unit and Accessories	4
Product Feature	4

Introduction	5-9
1. Front View	5
2. Rear View	6
3. Instruction for Wall Mount	7
4. Remote Control	8-9

First Time Installation	10-11
Basic Operation	12

OSD Menu	13-21
1. Picture menu	13-14
2. Sound menu	15
3. Channel menu	16-17
4. Parental Control menu	18-19
5. Setup menu	20
6. Others menu	21

Simple Troubleshooting	22
-------------------------------	-----------

Technical Specifications	23
---------------------------------	-----------

Caution



The lightning flash with arrowhead symbol, within an equilateral triangle is intended to alert the user to the presence of un-insulated "dangerous voltage" within the products enclosure that may be of sufficient magnitude to constitute a risk of electric shock to the persons.



The exclamation point within an equilateral triangle is intend to alert the user to the presence of important operating and maintenance (servicing) instructions in the literature accompanying the appliance.



Correct disposal of this Product

(Waste Electrical & Electronic Equipment (WEEE))

Your product is designed and manufactured with high quality materials and components which can be recycled and reused.

This symbol means that electrical and electronic equipment, at their end-of-life should be disposed of separately from your household waste.

Please dispose of this equipment at your local community waste collection/ recycling centre.

In the USA there are separate collection systems for used electrical and electronic products. Please help us to conserve the environment we live in!

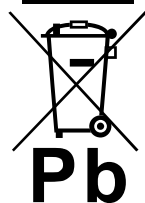

This unit complies with America Safety directives.

Intertek

31 24 14 0

CONFORMS TO UL STD. 60065

CERTIFIED TO CSA STD. C22.2 No.60065



This unit complies with FCC directives.



LAMP(S) INSIDE THIS PRODUCT CONTAIN MERCURY AND MUST BE RECYCLED OR DISPOSED OF ACCORDING TO LOCAL, STATE OR FEDERAL LAWS.

ENERGY STAR®:

This Westinghouse product has earned the Energy Star® for meeting U.S. Federal energy efficiency guidelines as set by the Department of Energy and Environmental Protection agency. The Energy Star® program exists to provide energy saving guidelines and help promote energy efficient products and practices. Changes to certain features, settings and functions of this TV can change and/or increase its power consumption. Depending on how settings are changed, power consumption may exceed the limits required for Energy Star® qualification. This Westinghouse TV will operate at optimal energy efficiency in "Home" mode.

Safety Information

To ensure reliable and safe operation of this equipment, please read carefully all the instructions in this user guide, especially the safety information below.

Electrical safety

- To prevent overload, don't share the same mains supply socket with too many other items of equipment.
 - Do not place any connecting wires where they may be stepped on or tripped over.
 - Do not place heavy items on the leads, which may damage them.
 - Hold the Mains plug, not the wires, when removing from a socket.
 - During a thunderstorm or while leaving the TV for long periods, disconnect the aerial (if outdoor) and the power cable from the supply.
 - Do not allow water or moisture to enter the TV . Do NOT use in wet or moist areas such as Bathrooms, steamy kitchens or near swimming pools.
- Pull the plug out immediately, and seek professional help if:
 - the mains plug or cable is damaged
 - liquid is spilt onto the set, or if it is accidentally exposed to water or moisture
 - anything accidentally penetrates the ventilation slots
 - the set does not work normally.
 - Do NOT remove the safety covers. There are no user serviceable parts inside. You may invalidate the warranty. Qualified personnel only are permitted to service this apparatus.
 - To avoid battery leakage, remove exhausted batteries from the remote control handset, or when not using for along period.
 - Do NOT break open or throw exhausted batteries on a fire.

Physical safety

- Do NOT block ventilation slots in the back cover. You may place the TV in a cabinet, but ensure at least 5cm (2") clearance all around the unit.
- Do NOT tap or shake the TV screen, you may damage the internal circuitry. Take good care of the remote control, do not drop it or allow it to come into contact with liquids.
- To clean the TV use a soft dry cloth. Do NOT use solvents or petrol based fluids. For stubborn stains, you may use a damp soft cloth with diluted detergent.

Unit and Accessories

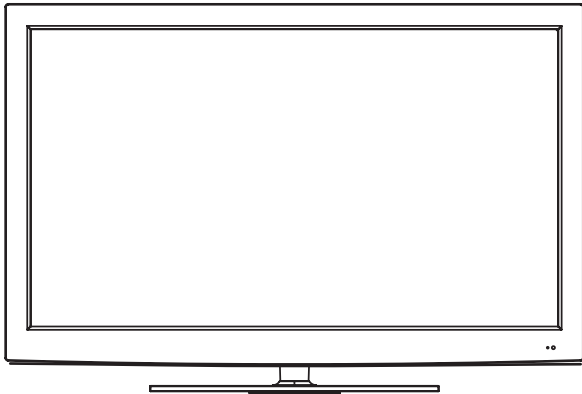

TV set



Warranty Card



Quick Connect Guide

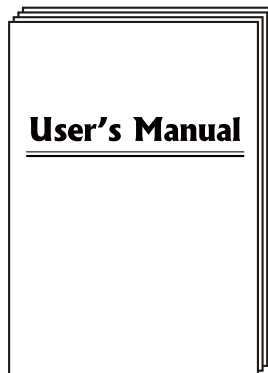

User's Manual



Remote Control and Batteries (AAA x2)

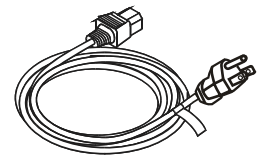

Power Cord

Product Feature

- 39" (measured diagonally) wide screen for a complete home theater experience
- 1920 x 1080 native resolution for Full-HD(1080p) performance
- Integrated ATSC TV tuner for HDTV broadcast reception
- Three HDMI® inputs for true digital connections
- VGA port for connection to PC

HDMI is a trademark of HDMI Licensing LLC in the United States and other countries.

Introduction

1. Front View

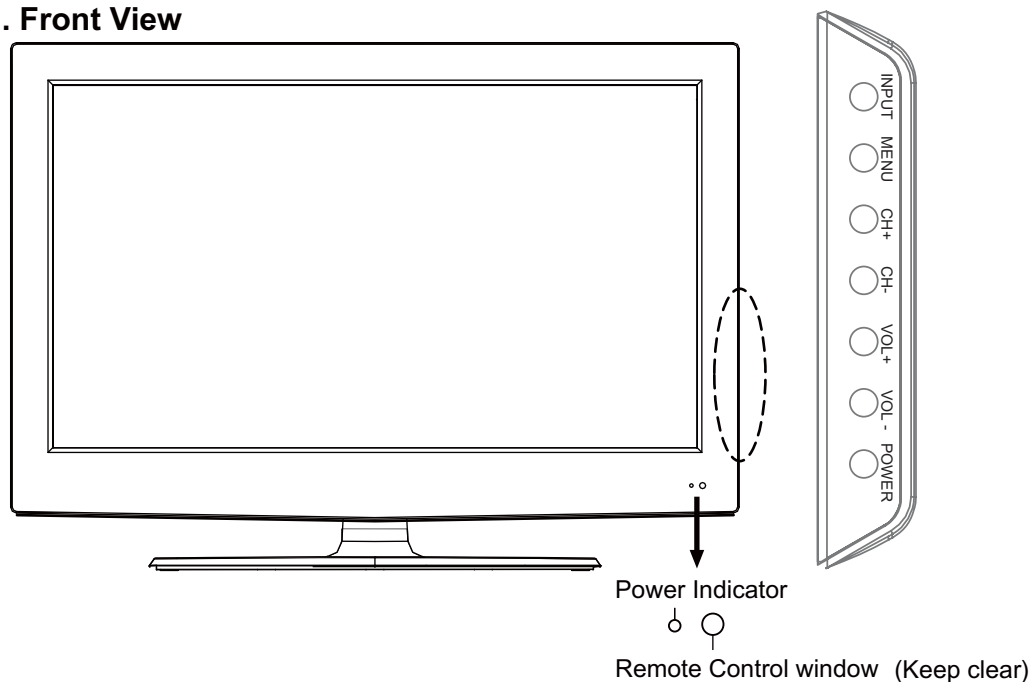

- 1). (IR) Infrared Receiver: Receives IR signals from the remote control.
 (Power on/Standby)LED Indicator: Press **POWER** to turn on and off.

Indicator on(Red)	Standby mode
Indicator on(Green)	Power on mode

The effective receiving range for the signal is 5-8 metres from the front of the remote control window, and 30° to the left or right side and 20° above or below the remote control window.

- 2). The functions of the buttons:

INPUT: Press to display the input source menu. →
MENU: Press to display the OSD menu, press again to exit the menu.
CH+/-: Press to scan through channels.
VOL+/-: Press to adjust the volume.
POWER: Turn on/standby the TV set.

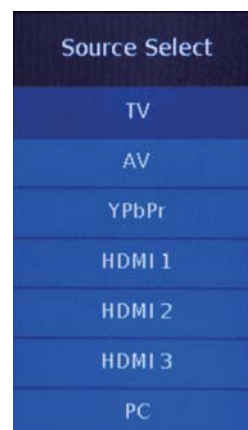

Press **INPUT** button on the TV set or remote control to display the input source menu, and use **CH+/-** button on the TV set or **^ / v** button on remote control to select the input source, press **OK** button on the remote control to enter.

Note: Before you select the input source, make sure the connections are prepared.

2. Rear View

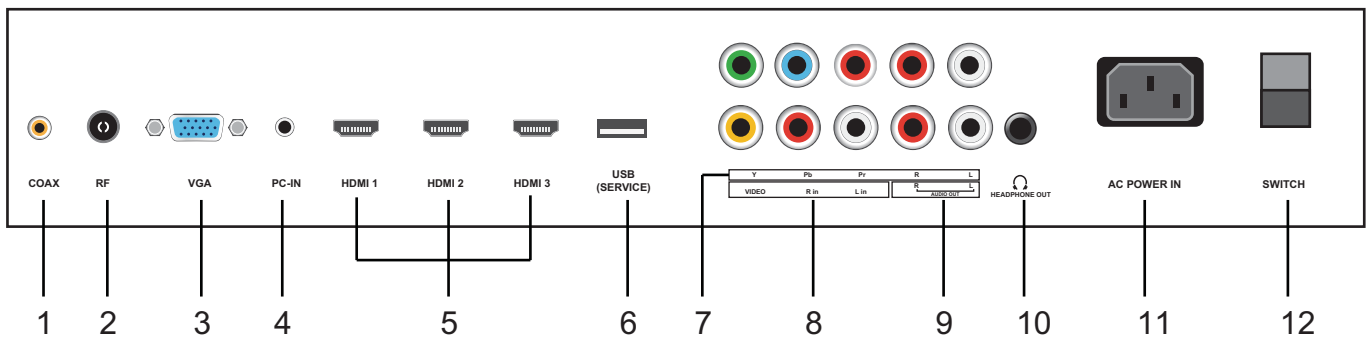
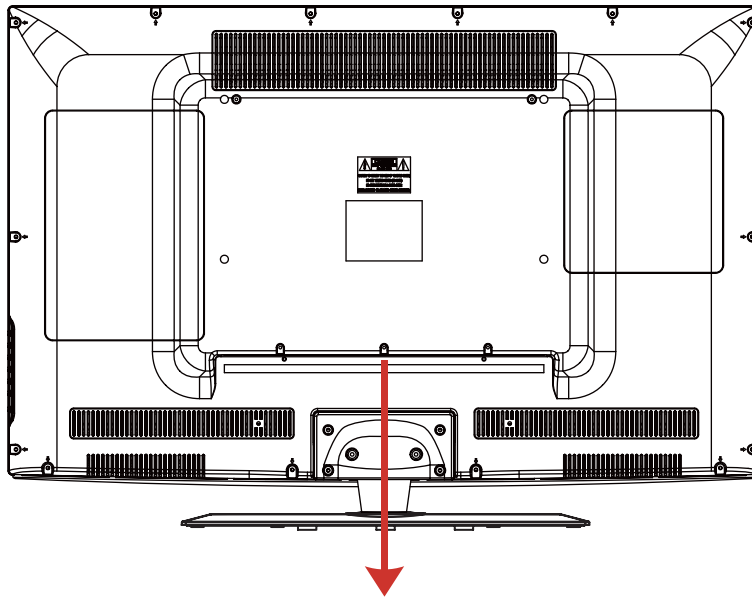

- 1). **COAX** : Digital audio output.
- 2). **RF** : Connect antenna or cable 75 Ohm coaxial to receive TV signal.
- 3). **VGA** : For PC display. Connect it to the D-Sub 15 pins analog output of the PC.
- 4). **PC IN** : Connect it to the audio output of PC.
- 5). **HDMI1/2/3** : Connect it to the HDMI output of video device.
- 6). **Service** : For service use only.
- 7). **YPbPr** : Connect them to the component video output of video device.
L/R in : Connect them to audio output of video device.
- 8). **VIDEO** : Connect it to video output of video device.
L/R in : Connect them to audio output of video device.
- 9). **L/R out** : Connect them to audio equipments.
- 10). **Headphone out** : Connect it to your headphone or audio equipments.
- 11). **AC POWER IN**: Connect to an earth 100-240V~ 50/60Hz outlet with the power cable.
- 12). **SWITCH**: Switch on/off the power supply.

3. Instruction for Wall Mount

A wall mount kit (purchased separately) would allow you to mount your Westinghouse TV on the wall. For detailed information on installing the wall mount, refer to the instructions provided by the wall mount manufacturer. It is strongly recommended to contact a technician for professional assistance for wall mount installation. Westinghouse is not responsible for any damage to the product or injury to yourself or others resulting from the wall-mounting.

Dimensions for Mounting Hole Pattern

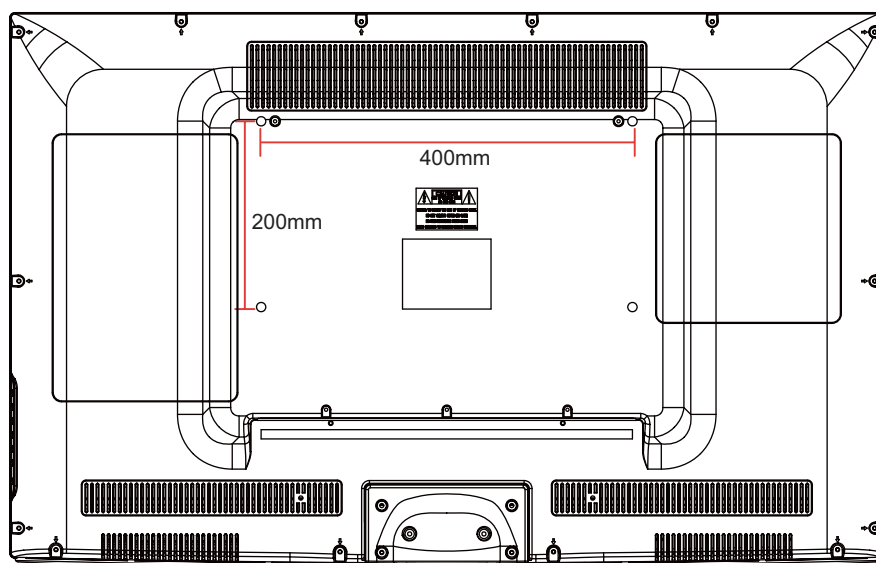

- This Westinghouse TV is compatible with a 400mm x 200mm mounting hole pattern.
- 4 pcs of type M5 screws are required for installing the wall mount bracket to your Westinghouse TV. Do not use screws that are longer than 15 mm. Screws that are too long may cause damage to the inside of the TV set.
- Do not fasten the screws too tight for this may damage the TV or cause the TV to fall, resulting in personal injury. Westinghouse is not liable for these kinds of incidents.
- Do not mount your Westinghouse TV at more than a 15 degree tilt.
- Always use two people to mount the TV to a wall.
- Do not install your Wall Mount Kit while your TV is turned on. It may result in personal injury due to electric shock.

4. Remote Control

The remote control is using Infra-Red(IR). Point it towards the front of the TV. The remote control may not work correctly if it is operated out of range or out of angle.

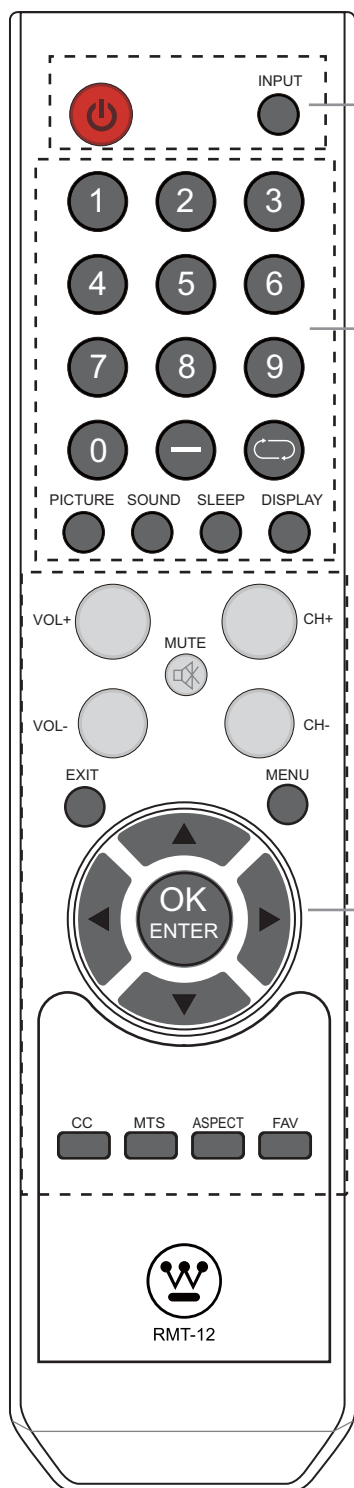

POWER(red button): Turn the TV on/standby.
INPUT: Press to display the input source menu.

Number Buttons: Choose channel directly.
 Select channel 5, Press button "5";
 Select channel 62, Press button "6", then press button "2" in 2 seconds;
 Select channel 151, Press button "1", and press button "5" in 2 seconds, and press button "1" in 2 seconds;
 Select channel 5-1, Press button "5", and press button "-" in 2 seconds, and press button "1" in 2 seconds;
(RETURN): Return to the previous channel viewed.
PICTURE: Press repeatedly to cycle through the available video picture modes.
SOUND: Press to cycle through the different sound settings.
SLEEP: Shutdown timer.
DISPLAY: Display the information of current mode.

VOL+/-: Press to adjust the volume.
CH+/-: Press to scan through channels.
MUTE: Press to mute the sound, press again or press VOL+ to unmute.
MENU: Press to display the OSD menu.
EXIT: Press to exit the OSD menu.
Thumbstick(< > v ^): Allows you to navigate the on-screen menus and adjust the system settings to your preference.
OK: CONFIRM button.
CC: Press to display the closed caption.
MTS: Press to select the audio channels.
ASPECT: Press to change the aspect for pictures on screen.
FAV: Press to add or remove favorite channel.

Installing Batteries

1. Open the battery compartment cover on the back of the remote control.
2. Insert two 1.5V AAA size batteries observing the polarity markings inside the battery compartment. Don't mix different types or used batteries with new ones.
3. Close the cover.



Batteries shall not be exposed to excessive heat such as sunshine or fire.

- The remote control should be operated within 23 feet(7m) and 30° to the left and right of the IR Receiver on the front of the TV.
- Used batteries should be disposed properly.

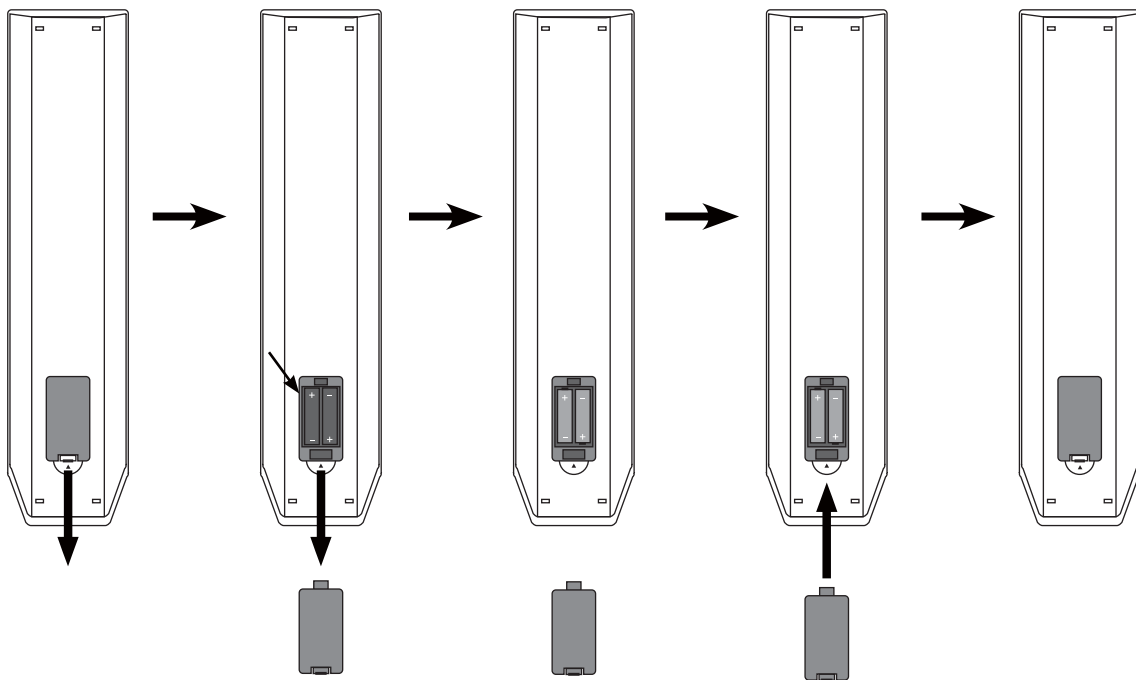

First Time Installation

The following pictures will appear on the screen when the TV is turned on for the first time.



1. Select the OSD menu language by \wedge / \vee button, and press OK/ENTER button to enter the next menu.

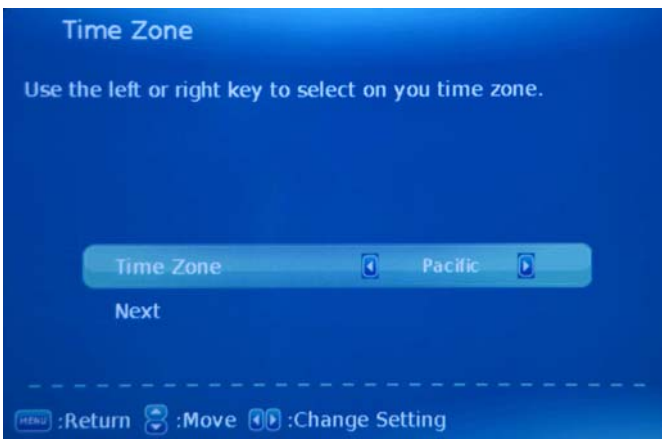

2. Select the Time Zone by \lt / \gt button, then select Next item by \wedge / \vee button and press OK/ENTER button to enter the next menu.

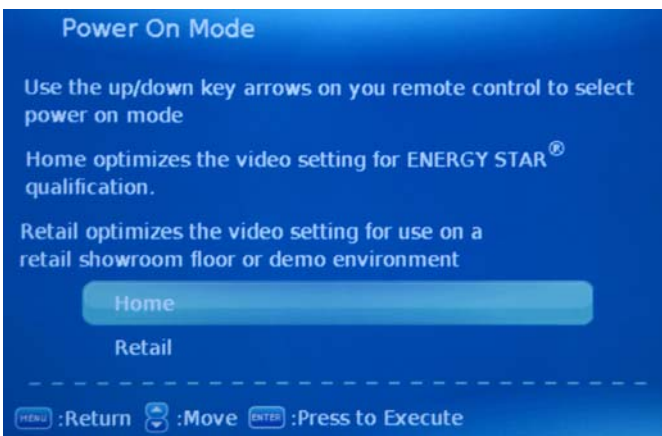

3. Select the power on mode by \wedge / \vee button, and press OK/ENTER button to enter the next menu.

Note:
Home mode --- Power saving mode.
Retail mode --- Normal mode.

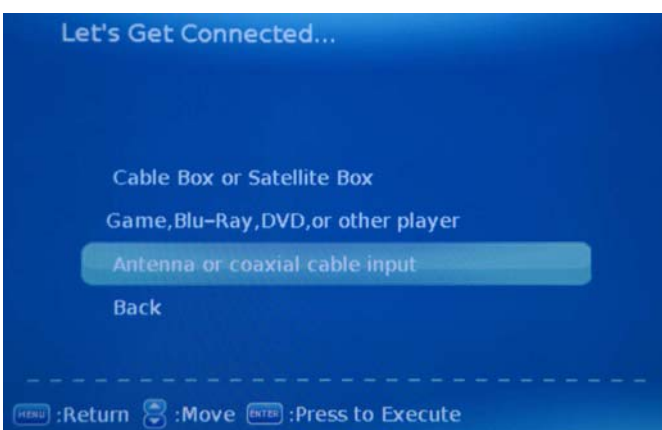

4. Select the **Antenna or coaxial cable input** connect mode by \wedge / \vee button, and press OK/ENTER button to enter the next menu.

Note:
*** Cable Box or Satellite Box--- If you want using the signals from the cable box or satellite box, please select this item and press OK/ENTER button to setting.**
*** Game, Blu-Ray, DVD or other player --- If you want using the signals from the Game, Blu-Ray, DVD or other player, please select this item and press OK/ENTER button to setting.**

First Time Installation

5. Select the **Antenna [ATSC] or Cable** mode by \wedge / \vee button, and press OK/ENTER button to enter the next menu.

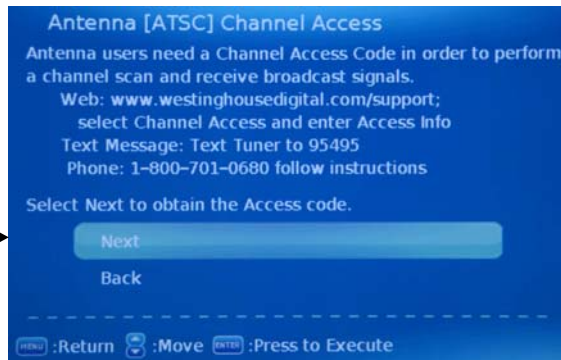
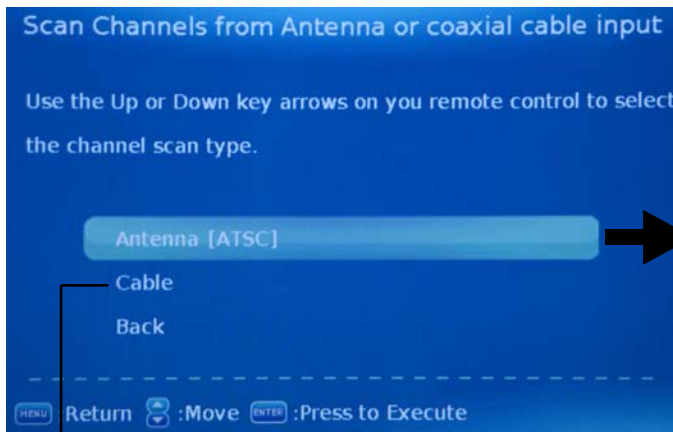

6. Select Next item by \wedge / \vee button and press OK/ENTER button to enter the next menu.

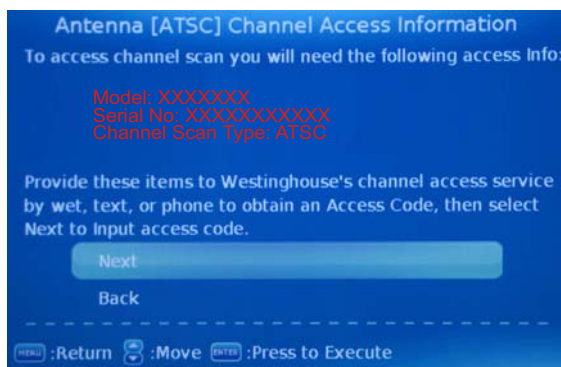

7. Select Next item by \wedge / \vee button and press OK/ENTER button to enter the next menu.

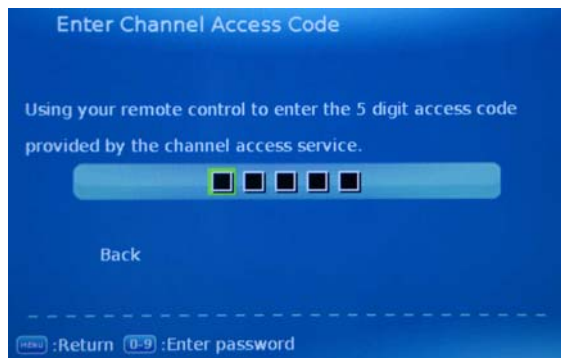

8. Enter the code by the number buttons on the remote control to start the auto channel search.

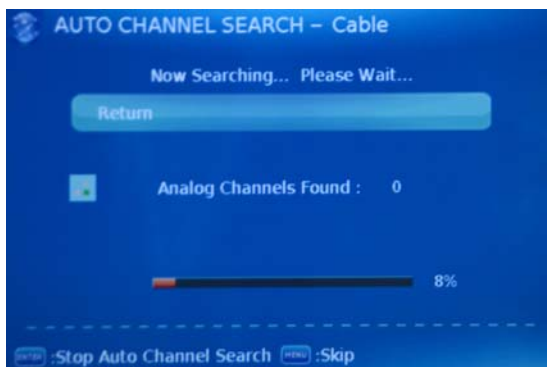

- *6. The auto searching may take a few minutes to complete.

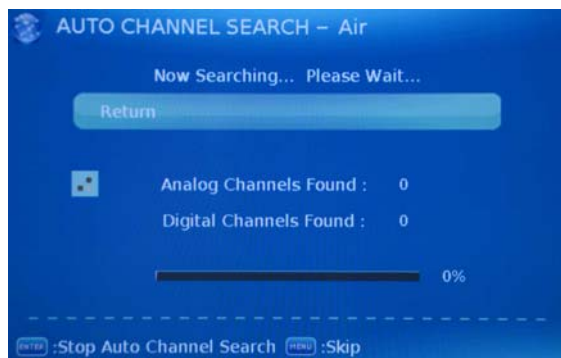

9. The auto searching may take a few minutes to complete.

Basic Operation

Power on/off

1. Connect to the power supply with the power cord, and turn on the switch.
2. -To turn on the TV
Press **POWER** button on the TV or remote control.
- To turn off the TV
Press **POWER** button on the TV or remote control.

Source Select
TV
AV
YPbPr
HDMI 1
HDMI 2
HDMI 3
PC

Input Source select

Press **INPUT** button on the TV set or remote control to display input source menu, and use **CH+/-** button on the TV set or \wedge/\vee button on remote control to select the input source, press **OK** button on the remote control to enter.

Note: Before you select the input source, make sure the connections are prepared.

Basic OSD Menu operation

Press **MENU** button to display the OSD menu as below:

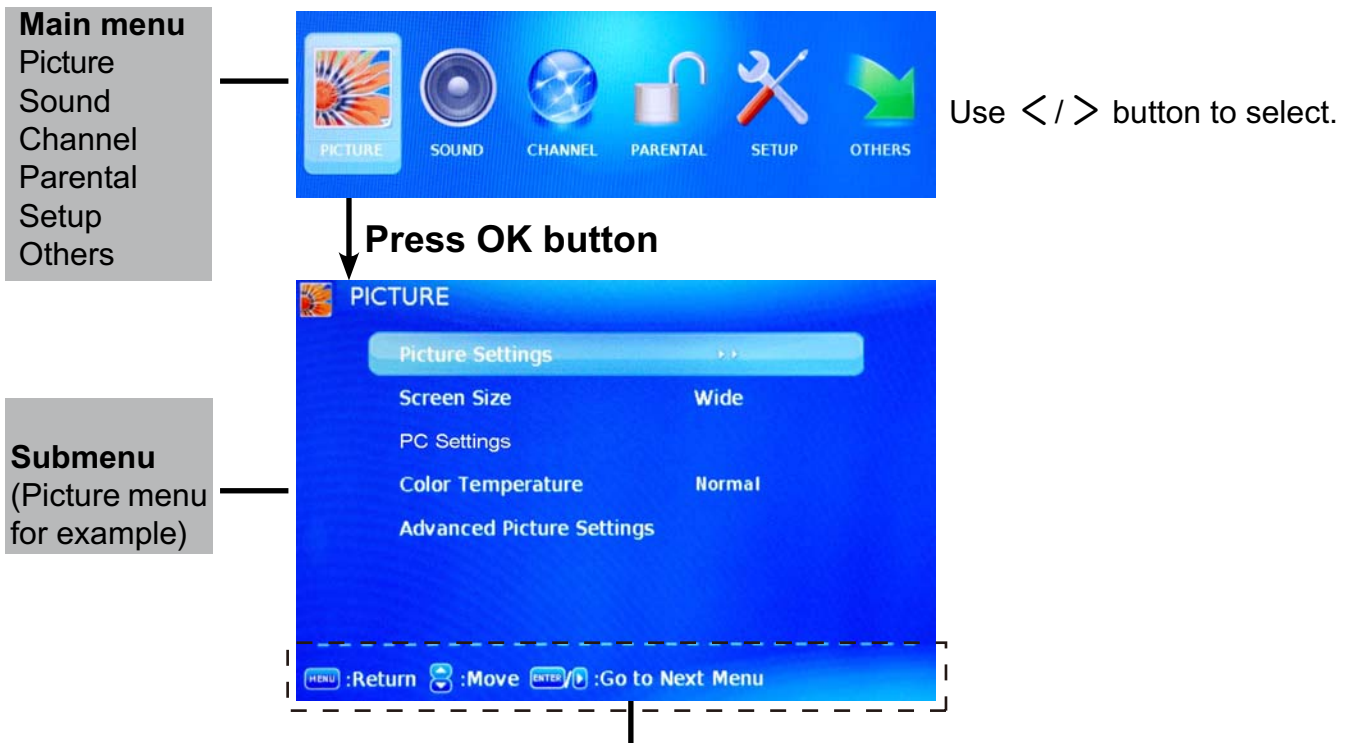

Guide - This guide shows the keys (buttons) on the remote control for selecting the items to setup in the OSD menu.

Use \langle / \rangle button to select the main menu, and press **OK** button to enter the submenu. In the submenu, use \wedge/\vee button to select the function item, press \langle / \rangle button to adjust/setup, or press \rangle button to enter the submenu.

* (Press **MENU** button to return to the upper menu.)

* (Press **EXIT** button to exit the menu display.)

OSD Menu

1. Picture menu

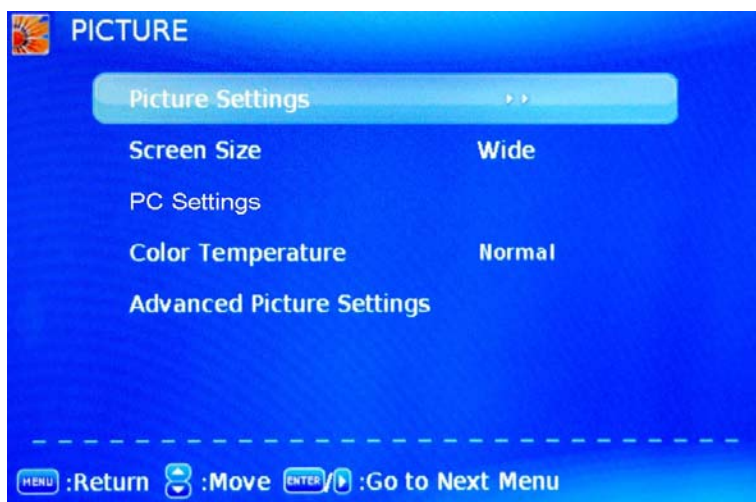

Description

Picture Settings: Press > button to enter the Picture Settings menu.



Picture mode: Select between Dynamic, Standard, Movie and User.

You may select the picture mode directly by pressing the PICTURE button on the remote control.

Note: when select the "Standard", the machine is in energy-saving status.

Brightness: Adjust brightness of the picture.

Contrast: Control the difference between the bright and dark regions of the screen picture.

Color: Adjust color of the picture.

Tint: Control the fresh tones to make them appear natural.

Sharpness: Set the amount of fine detail in the picture.

Screen Size: Select the displaying mode of the picture between Wide, Cinema, Zoom, Normal, Just Scan, Standard, Fill, and Over scan.

PC Settings: If the video input signal comes from your PC, you may adjust the Vertical Position, Horizontal Position, Clock, Phase or even perform an Auto adjustment.



Auto Adjust: Press OK button to setup the parameter of the screen automatically.

Clock: Adjust the pixel clock frequency, until the image size is maximized for the screen.

H/V Position: Adjust the transverse/vertical position of the screen.

Phase: Adjust the phase of the ADC sampling clock relative to the sync signal, until a stable image is obtained.

Reset: Press OK button to reset the settings.

Color Temp.: Select between Normal, Cool and Warm.

OSD Menu

Advanced Picture Settings: Press > button to enter the Advanced Picture Settings.

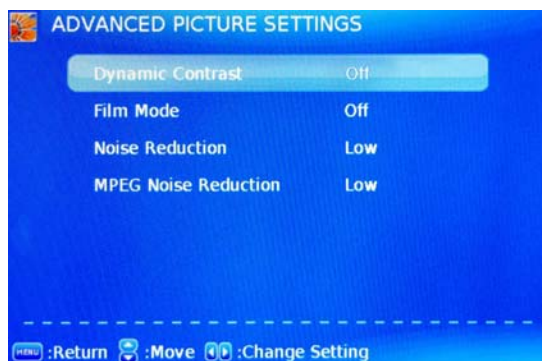

Dynamic Contrast: Activate or deactivate the Dynamic Contrast function.

Film Mode: Activate or deactivate the Film Mode.

Noise Reduction: If the broadcast signal received is weak, you can select the DNR option to reduce the video noise level between Off, Low, Medium and High.

MPEG Noise Reduction: Select the MPEG Noise Reduction option to reduce the picture noise level between Off, Low, Medium and High.

OSD Menu

2. Sound menu



Description

Sound Settings: Press > button to enter the Sound Settings menu.



Sound Mode: Select your desired picture mode as follow: Dynamic, Standard, Soft and User. You may select the sound mode directly by pressing the SOUND button on the remote control.

Bass: Low frequency intensity.

Treble: High frequency intensity.

Balance: Left and right stereo audio channels balance.

Surround Mode: Activate or deactivate the Surround function.

AVL: Activate or deactivate the Auto Volume Limited function.

Analog Sound: Select the Analog Sound mode between Stereo, Mono and SAP.

Digital Sound: Select the Digital Sound language.

Digital Audio Output: Select the Digital Audio Output mode between PCM, RAW and off.

Equalizer Settings: Press > button to enter the Equalizer Settings menu.



Use </> button to select the mode between User, Off, Rock, Pop and Jazz.

You could press √ button to enter the bottom item to adjust the equalizer by yourself when you select the User mode.

Use </> button to select the item, and use ^/∇ button to adjust. You could come back to the Mode selecting item by pressing < button.

OSD Menu

3. Channel menu



Description

Channel List: Display the channel list.

Favorite List: Display the favorite channel list.

Channel Settings: Press > button to display the Channel Settings menu.



Press <>^v button to select the item, and press OK button to change the setting.

Signal Type: Allow you to select antenna between Air, Cable and QAM.

Auto Channel Search: Press OK button to start auto channel search.

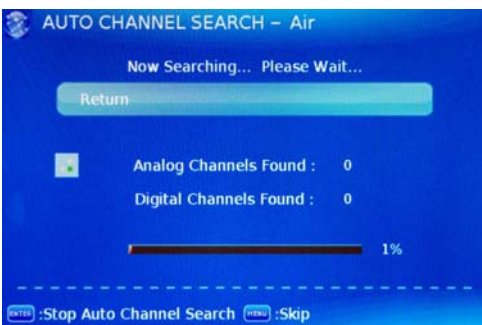

★ If you select “Air” as input signal in Signal Type item, you can press > button to search the channels automatically. The receivable channels will be stored automatically. When searching channels, press **MENU** to stop. NOTE: It will take a while to auto scan in NTSC or ATSC mode, please wait patiently.

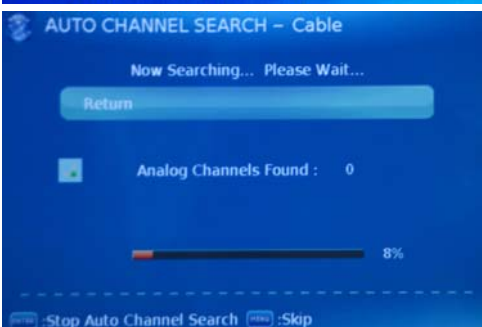

★ If you select “Cable” as input signal in Signal Type item, you can press > button to search the analog channels automatically. The receivable channels will be stored automatically. When searching channels, press **MENU** to stop.

OSD Menu

★ If you select “QAM” as input signal in Signal Type item, you can press > button to search the channels automatically. The receivable channels will be stored automatically. When searching channels, press **MENU** to stop.

NOTE: It will take a while to auto scan in NTSC or ATSC mode, please wait patiently.

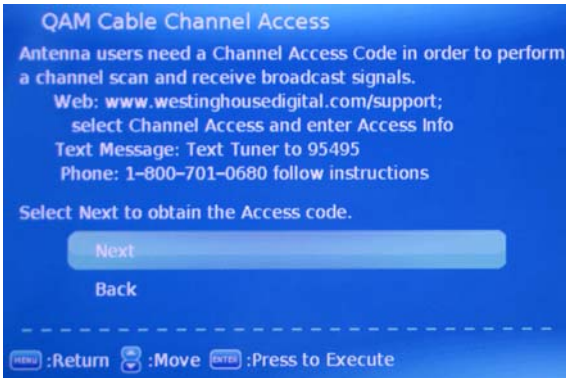

1. Select Next item by ^ / v button and press OK/ENTER button to enter the next menu.

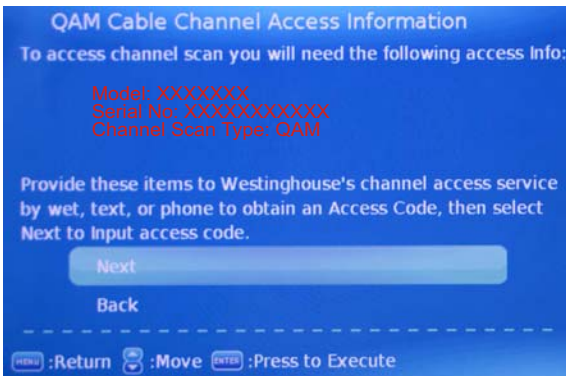

2. Select Next item by ^ / v button and press OK/ENTER button to enter the next menu.

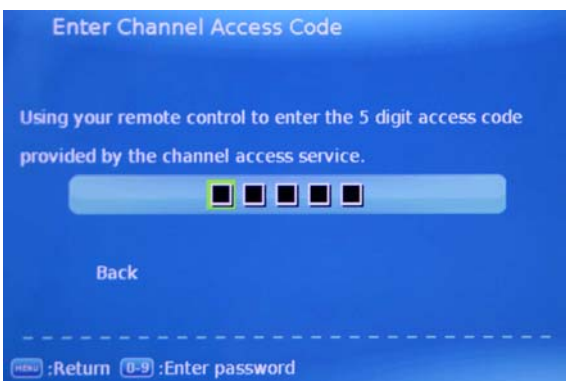

3. Enter the code by the number buttons on the remote control to start the auto channel search.

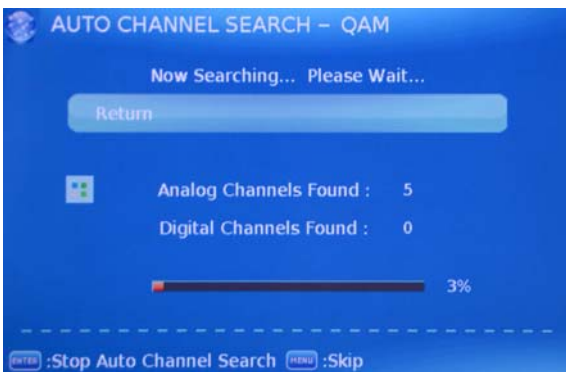

OSD Menu

4. Parental Control menu

You must enter the password to gain access to the Parental Control menu. The default password is 0000. You may modify the following options:



Description

V-CHIP: Press > button to enter the V-CHIP menu.



US V-CHIP: Press > button to enter the US V-CHIP menu.

Movie Rating: The Movie rating (MPAA) is used for original movies rated by the Motion Picture Association of America (MPAA) as broadcasted on cable TV and not edited for television.

Use ^ / v button to select G, PG, PG-13, R, NC-17 or X.

G: General Audiences. Movie is appropriate for all ages.
PG: Parental Guidance Suggested. May contain material not suited for younger viewers.
PG-13: Contains content that may not be appropriate for viewers under the age of 13.
R: Restricted. Contains adult content, no one under 17 admitted without parent.
NC-17: No one 17 and under admitted.
X: Adults only.

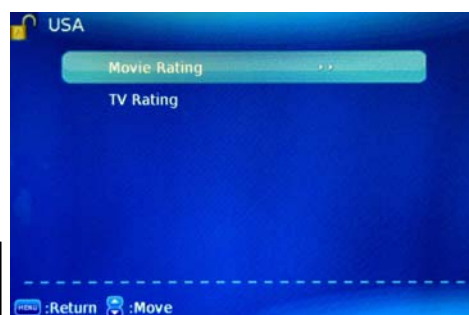

TV Rating: Use ^ / v buttons to select the desired rating and press > button to block or unblock rating.

OSD Menu

Canada V-CHIP: Press > button to enter the Canada V-CHIP menu.

English Rating: Select among: C, C8+, G, PG, 14+ and 18+.

French Rating: Select among: G, 8ans+, 13ans+, 16ans+ and 18ans+.



Block UnRated Show: Activate or deactivate the Block UnRated Show function.

Downloadable Rating: Setting the Downloadable Rating in DTV mode when the program has the rating information.

Clear Downloadable Data: Clear the downloadable data of the TV.

Note: The two operations above only valid when playing the downloadable data stream.

Change password: Change the password, you must enter the new password twice to confirm it.

Note: Do not forget the password.



Keypad Lock: Invalidate the buttons one the TV set.

Source Lock: Invalidate the source input you select.

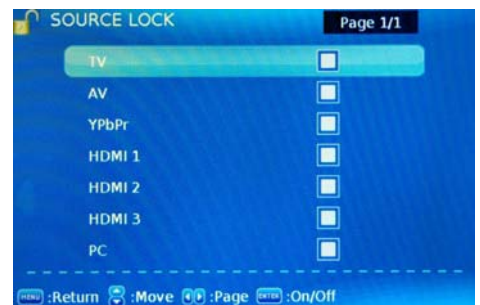

OSD Menu

5. Setup menu

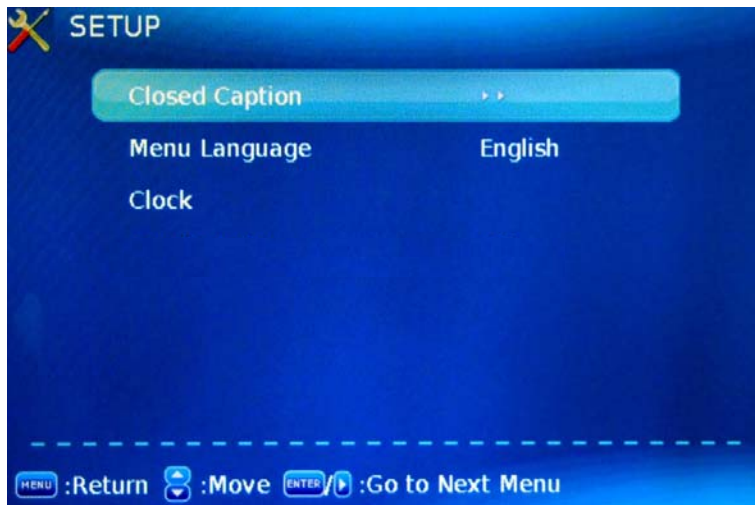

Description

Closed Caption: Press > button to enter the Closed Caption menu.



Caption Display: Activate or deactivate the Caption displaying.

Analog Caption Type: Allow you to select the basic selection among: CC1, CC2, CC3, CC4, Text1, Text2, Text3 and Text4.

Digital Caption Type: Allow you to select the advanced selection among: Service1, Service2, Service3 Service4, Service 5 and Service 6.

Digital CC Preset: Select the Digital CC Preset between Default and Custom.

Digital CC Style: Setting the Digital CC Style.

Menu Language: Select OSD menu language.

Clock: Press > button to enter the Clock menu.

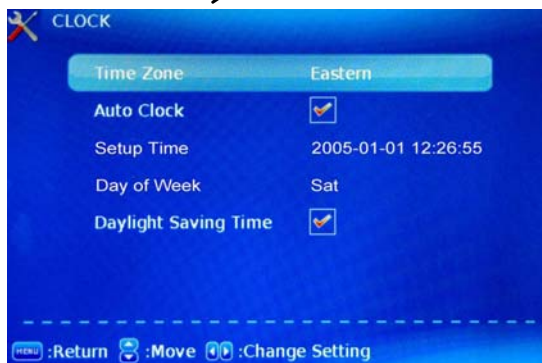

Time zone: Select the time zone for the TV.

Auto Clock: Activate or deactivate the Auto Clock function.

Setup Time: Display the setup time of the TV.

Day of Week: Display the day of week.

Daylight Saving Time: Activate or deactivate the Daylight Saving Time function for the TV.

OSD Menu

6. Others menu



Description

Blue Back: Turn on/off the blue screen function when there's no signal.

No Signal Power Off: The TV will turn off automatically if there's no signal after 10 minutes.

No Operation Power Off: The TV will turn off automatically if there's no operation on the TV after 3 hours.

All Reset: Enter the password (the same password for Parental Control menu) and reset all the settings.



Simple Troubleshooting

If the TV has failed or its performance has seriously deteriorated, check the TV by using the following simple troubleshooting guide.

If you can not resolve the problem with this troubleshooting, please call Westinghouse Technical Support.

No power

- Check all power connections to the TV.
- Press either the power button or the Standby button on the Remote control.

No picture or sound

- Ensure that the TV is plugged in and the power is on.
- Ensure that the antenna is connected.
- Try a different program.

Poor picture quality

- Check the antenna connections.
- Check if the channel is tuned in properly.
- Adjust the picture settings: brightness, color, sharpness, contrast, or hue.
- Make sure that the TV is not located close to electrical appliances that may emit radio frequency interference.

No color

- Adjust the color setting.
- Check if the program is color.
- Check if the channel is tuned properly.

TV does not respond to remote control

- Check if no obstruction is between the remote control and the unit.
- Check if the remote control is within the range of operation.
- Check if the batteries in the remote control is weak or exhausted.

This TV is for household use and registered as harmless on electromagnetic waves.

Technical Specifications

LCD Panel	Panel Size	39 inches (diagonal)
	Resolution	1920 x 1080
Input Connector	Video	1
	Audio(L/R)	2
	VGA	1
	PC Audio	1
	HDMI	3
	YPbPr	1
	RF	1
Output Connector	Headphone	1
	COAX	1
	Audio (L/R)	1
Power Source		AC 100 - 240V, 50/60Hz
Maximum Power Consumption		150W

* Product specifications and appearance are subject to change without notice.



HDMI, the HDMI Logo, and High-Definition Multimedia Interface are trademarks or registered trademarks of HDMI Licensing LLC in the United States and other countries.



www.westinghousedigital.com



S/N: _____



Westinghouse Digital, LLC
Orange, CA

SE-UM-3901-1201