

DUCT TYPE AIR CONDITIONER

Operation & Installation Manual

AD142AMBIA
AU142AFBIA

- Please read this operation manual before using the air conditioner.

No. 0010572912

A

TABLE OF CONTENTS

CAUTIONS	2
SAFETY PRECAUTIONS	3-5
PARTS AND FUNCTIONS.....	6
MALFUNCTION	7-8
CARE AND MAINTENANCE	9-10
INSTALLATION MANUAL FOR OUTDOOR UNIT	11-14
INSTALLATION MANUAL FOR INDOOR UNIT	15-20
INSTALLATION MANUAL FOR ELECTRIC WIRING	21
INSTALLATION MANUAL FOR WIRE CONTROLLER	22
CHECK AND TEST RUN	23

■ CAUTIONS

Disposal of the old air conditioner

Before disposing an old air conditioner that goes out of use, please make sure it's inoperative and safe. Unplug the air conditioner in order to avoid the risk of child entrapment.

It must be noticed that air conditioner system contains refrigerants, which require specialized waste disposal. The valuable materials contained in a air conditioner can be recycled. Contact your local waste disposal center for proper disposal of an old air conditioner and contact your local authority or your dealer if you have any question. Please ensure that the pipework of your air conditioner does not get damaged prior to being picked up by the relevant waste disposal center, and contribute to environmental awareness by insisting on an appropriate, anti-pollution method of disposal.

Disposal of the packaging of your new air conditioner

All the packaging materials employed in the package of your new air conditioner may be disposed without any danger to the environment.

The cardboard box may be broken or cut into smaller pieces and given to a waste paper disposal service. The wrapping bag made of polyethylene and the polyethylene foam pads contain no fluorochloric hydrocarbon.

All these valuable materials may be taken to a waste collecting center and used again after adequate recycling.

Consult your local authorities for the name and address of the waste materials collecting centers and waste paper disposal services nearest to your house.

Safety Instructions and Warnings

Before starting the air conditioner, read the information given in the User's Guide carefully. The User's Guide contains very

important observations relating to the assembly, operation and maintenance of the air conditioner.

The manufacturer does not accept responsibility for any damages that may arise due to non-observation of the following instruction.

- Damaged air conditioners are not to be put into operation. In case of doubt, consult your supplier.
- Use of the air conditioner is to be carried out in strict compliance with the relative instructions set forth in the User's Guide.
- Installation shall be done by professional people, don't install unit by yourself.
- For the purpose of safety, the air conditioner must be properly grounded in accordance with specifications.
- Always remember to unplug the air conditioner before opening inlet grill. Never unplug your air conditioner by pulling on the power cord. Always grip plug firmly and pull straight out from the outlet.
- All electrical repairs must be carried out by qualified electricians. Inadequate repairs may result in a major source of danger for the user of the air conditioner.
- Do not damage any parts of the air conditioner that carry refrigerant by piercing or perforating the air conditioner's tubes with sharp or pointed items, crushing or twisting any tubes, or scraping the coatings off the surfaces. If the refrigerant spurts out and gets into eyes, it may result in serious eye injuries.

Do not obstruct or cover the ventilation grille of the air conditioner. Do not put fingers or any other things into the inlet/outlet and swing louver.

Do not allow children to play with the air conditioner. In no case should children be allowed to sit on the outdoor unit.

SAFETY PRECAUTIONS

- Before starting to use the system, read carefully this "SAFETY PRECAUTIONS" to ensure a proper operation of the system.
- Safety precautions described here are classified to "⚠ WARNING" and "⚠ CAUTION". Precautions which are shown in the column of "⚠ WARNING" means that an improper handling could lead to a grave result like a death, serious injury, etc. However, even if precautions are shown in the column of "⚠ CAUTION", a very serious problem could occur depending on situation. Make sure to observe these safety precautions faithfully because they are very important information to ensure the safety.
- Symbols which appear frequently in the text have following meanings.

	Strictly prohibited.		Observe instructions faithfully.		Provide a positive grounding.
---	----------------------	---	----------------------------------	---	-------------------------------

- When you have read through the manual, keep it always at hand for read consultation. If the operator is replaced, make sure to hand over this manual to the new operator.

CAUTIONS FOR INSTALLATION

⚠ WARNING

The system should be applied to places as office, restaurant, residence and the like.



Application to inferior environment such as an engineering shop, could cause equipment malfunction and serious injury or death.

The system should be installed by your dealer or a professional installer.



Installation by yourself is not encouraged because it could cause such problems as water leakage, electrical shock or fire accident by some improper handling.

When you need some optional devices such as a humidifier, electric heater, etc., be sure to use the products which are recommended by us. These devices should be attached by a professional installer.



Installation by yourself is not encouraged because it could cause such problems as water leakage, electrical shock or fire accident by some improper handling.

⚠ CAUTION

Do not install nearby the place where may have leakage of flammable gas.



If the gas leaks and gathers around, it may cause the fire.

Depending on the place of installation, a circuit breaker may be necessary.



Unless the circuit breaker is installed, it could cause electrical shocks.

Drain pipe should be arranged to provide a positive draining.

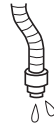

If the pipe is arranged improperly, furniture or the likes may be damaged by leaked water.

Where strong winds may prevail, the system should be fixed securely to prevent a collapse.



Bodily injury could result by a collapse.

Install on the place where can endure the weight of air conditioner.



Bodily injury could result by a careless installation.

Make sure the system is grounded.



Grounding cable should never be connected to a gas pipe, city water pipe, lightning conductor rod or grounding cable of telephone. If the grounding cable is not set properly, it could cause electric shocks.

CAUTIONS FOR OPERATION

⚠ WARNING

You should refrain from exposing your body directly to cool wind for a long time.



It could affect your physical condition or cause some health problems.

Do not poke the air inlet or outlet with a bar, etc.

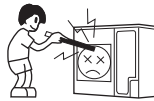

Since the internal fan is operating with a high speed, it could cause an injury.

When any abnormal condition (scorching smell or others) is found, stop the operation immediately and turn off the power switch. Then consult your dealer.



If you continue the operation without removing the cause, it could result in a trouble, electric shock or fire.

⚠ CAUTION

The system should never be used for any other purposes than intended such as for preservation of food, flora and fauna, precision devices or work of art.

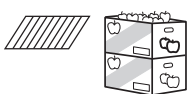

It could cause deterioration of food or other problems.

Do not handle switches with a wet hand.



It could cause electric shocks.

Combustion apparatus should not be placed allowing a direct exposure to wind of air conditioner.

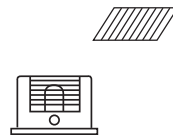

Incomplete combustion could occur on the apparatus.

SAFETY PRECAUTIONS

⚠ CAUTION

Do not wash the air conditioner with water.



It could cause electric shocks.

Do not install the system where the air outlet reaches directly the flora and fauna.



It will not be good for their health.

Make sure to use a fuse of proper electric rating.



Use of steel or copper wire in place of a fuse is strictly prohibited because it could result in a trouble or fire accident.

Neither stand on the air conditioner nor place something on it.

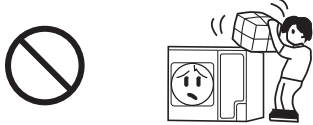

There are risks of falling or injury by collapsed object.

It is strictly prohibited to place a container of combustible gas or liquid near the air conditioner or to spray it directly with the gas or liquid.



It could cause a fire accident.

Do not operate the system while the air outlet grill is removed.



There is a risk of injury.

Do not use the power switch to turn on or off the system.

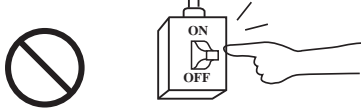

It could cause a fire or water leakage.

Do not touch the air outlet section while the swing louver is operating.



There is a risk of injury.

Do not use such equipment as a water heater, etc. around the indoor unit or the wire controller.



If the system is operated at the vicinity of such equipment which generates steam, condensed water may drip during cooling operation or it could cause a fault current or short-circuit.

When operating the system simultaneously with a combustion apparatus, indoor air must be ventilated frequently.



Insufficient ventilation could cause an oxygen deficiency accident.

Check occasionally the support structure of the unit for any damage after a use of long period of time.



If the structure is not repaired immediately, the unit could topple down to cause a personal injury.

When cleaning the system, stop the operation and turn off the power switch.



Cleaning should never be done while the internal fans are running with high speed.



If the structure is not repaired immediately, the unit could topple down to cause a personal injury.

CAUTIONS FOR TRANSFER OR REPAIR

⚠ WARNING

Modification of the system is strictly prohibited. When the system needs a repair, consult your dealer.



Improper practice of repair could cause water leakage, electric shock or fire.

When the air conditioner is relocated, contact your dealer or a professional installer.



Improper practice of installation could cause water leakage, electric shock or fire.

■ SAFETY PRECAUTIONS

The machine is adaptive in following situation

1. Applicable ambient temperature range:

			Rated	Maximum	Minimum
Cooling	Indoor	DB °C	27	32	18
		WB °C	19	23	14
	outdoor	DB °C	35	43	-5
		WB °C	24	26	--
Heating	Indoor	DB °C	20	27	15
		WB °C	14.5	--	--
	outdoor	DB °C	7	24	-7
		WB °C	6	18	--

2. If the supply cord is damaged, it must be replaced by the manufacturer or its service agent or a similar qualified person.
3. If the fuse on PC board is broken please change it with the type of T3.15A /250VAC.
4. The wiring method should be in line with the local wiring standard.
5. Use copper wire only. The connecting cable should be H05RN-F 4G 0.75mm².
The power cable should be H07RN-F 3G 2.5mm². All the cables shall have got the European authentication certificate.
6. The power supply connects from the outdoor side.
7. The breaker of the air conditioner should be all-pole switch; and the distance between its two contacts should be no less 3mm.
8. The indoor unit installation height is at least 2.5m.

Note:

Part of the power supply of the air conditioner are not prepared because of the requirement of the dealer, the power supply should be provided for oneself.

■ PARTS AND FUNCTIONS

Indoor Unit

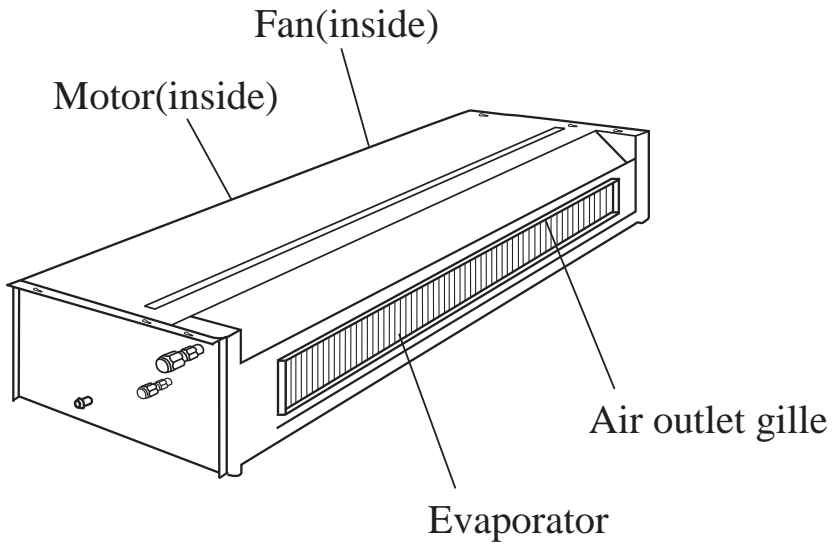

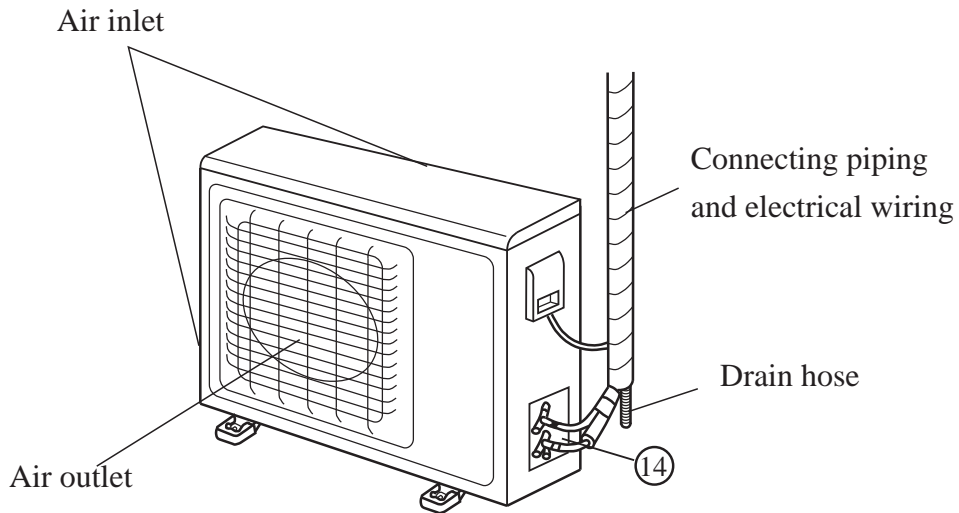

Outdoor Unit

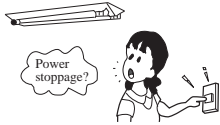

■ MALFUNCTION

please check the following things about your air conditioner before making a service call.

Unit fails to start			
Is the power source switch adjust cut in?  Power supply switch is not ON.	Is city supply power in normal? 	Isn't the signal receiving section exposed to the direct sunlight or strong illumination?	Isn't the earth leakage breaker in action? It is dangerous. Turn off the power supply switch immediately and contact the sales dealer.
Cooling or heating is not sufficient			
Is the thermostat adjust as required?	Isn't the air filter dirty?	Isn't any doors or windows left open?	Doesn't any obstacle exist at the air inlet or outlet?
Isn't the swing louver horizontal? (At HEATING mode) If swing louver is horizontal, the blow wind does not reach floor.	Cooling is not sufficient		
	Isn't sun-shine invading direct?	Isn't any unexpected heating load generated?	Isn't the room much crowded?
The wind does not blow during heating operation Isn't it warming up?  page 9	When the air conditioner does not operate properly after you have checked the above mentioned items or when the following phenomenon is observed, stop the operation of the air conditioner and contact your sales dealer. <ul style="list-style-type: none"> ● The fuse or breaker often shuts down. ● Water drops off during cooling operation. 		

- There is a irregularity in operation or abnormal sound is audible.
- When the CHECK lamp flickers, an irregularity has occurred in the air conditioner.

Flickering	F1	F2	F4	F5	F7	E1	E2	E3
Content of defect	The trouble of the room temp. sensor	The trouble of the pipe temp. sensor	The trouble of the overload heating	The trouble of the cooling ice over	The trouble of the wiring controller and outdoor communication	The trouble of the module	No load	The trouble of the indoor and outdoor communication



Flickering	E4	E5	E6	E7	E8	E0	EA	EC	EE
Content of defect	The trouble of the comp. too hot	The trouble of the overload current	The trouble of the outdoor room temp. sensor	The trouble of the outdoor pipe temp. sensor	singlechip bad	The trouble of the water pump	voltage of power supply too high	The trouble of the overload cooling	E2PROM bad

Note:

This unit has a function of automatic restart system after recovering power stoppage. Please contact the sales dealer if it is not required.

■ MALFUNCTION

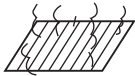
The followings are not malfunction

<p>Water flowing sound is heard.</p> 	<p>When the air conditioner is started, when the compressor starts or stops during operation or when the air conditioner is stopped, it sometimes sounds "shuru shuru" or "gobo gobo". It is the flowing sound of the refrigerant, and it is not a trouble.</p>
<p>Cracking sound is heard.</p>	<p>This is caused by heat expansion or contraction of plastics.</p>
<p>It smells.</p>	<p>Air which blows out from the indoor unit sometimes smells. The smell results from residents of tobacco smoke or cosmetics stuck inside of unit.</p>
<p>During operation, white fog comes out of indoor unit.</p> 	<p>When the air conditioner is used at restaurant etc. where dense edible oil fume is always exists, white fog sometimes blows out of air outlet during operation. In this case consult sales dealer for cleaning the heat exchanger.</p>
<p>It is switched into the FAN mode during cooling.</p>	<p>To prevent frost from being accumulated on the indoor unit heat exchanger, it is sometimes automatically switched to the FAN mode but it will soon return to the cooling mode.</p>
<p>The air conditioner can not be restarted soon after it stops.</p> 	<p>Even if the operation switch is turned on, cooling, dehumidifying or heating is not operable for three minutes after the conditioner is stopped. Because the protecting circuit is activated. (During this time air conditioner operates in fan mode.)</p> 
<p>Air does not blow or the fan speed can not be changed during dehumidifying</p>	<p>When it is excessively cooled during dehumidifying, the blower automatically repeats reducing and lowering the fan speed.</p>
<p>During operation, operation mode has changed over automatically.</p>	<p>Isn't the AUTO mode selected? In the case of AUTO mode, operation mode is changed automatically from cooling to heating or vise-versa according to the room temperature.</p>
<p>Water or steam generates from the outdoor unit during heating.</p>	<p>This results when frost accumulated on the outdoor unit is removed (during defrosting operation).</p>

CARE AND MAINTENANCE

Points to observe

Turn off the power supply switch.



Do not touch with wet hand.



Do not use hot water or volatile liquid.



⚠ CAUTION

- Do not open the inlet grill until fan stops completely.
- Fan will continue rotating for a while by the law of inertia after operation is being stopped.

Cleaning

1. Clean the air filter by lightly tapping it or with the cleaner. It is more effective to clean the air filter with water.

If the air filter is very dirty, dissolve neutral detergent in the lukewarm water (approx. 30°C), rinse the air filter in the water, and thoroughly wash the air filter off the detergent in the plain water.

2. After drying the air filter, set it up on the air conditioner.



⚠ CAUTION

- Do not dry the air filter with fire.
- Do not run the air conditioner without the air filter.

Care and Cleaning of the unit

- Clean with soft and dry cloth.
 - If it is very dirty, dissolve neutral detergent in the lukewarm water and make the cloth wet with the water.
- After wiping, clean off the detergent using clean water.

Post-Season Care

- Operate the unit with FAN mode on a fair day for about half a day to dry the inside of the unit well.
- Stop operation and turn off the power supply switch. Electric power is consumed even the air conditioner is in stop.
- Clean the air filter and set it in the place.

Pre-Season Care

See that there are no obstacles blocking the air inlet and air outlet of both indoor and outdoor units.

- Make sure that the air filter is not dirty.
- Cut in the power supply switch 12 hours before starting run.

CARE AND MAINTENANCE

"HOT KEEP" is operated in the following cases.

- When heating is started:
In order to prevent blowing out of cool wind, the indoor unit fan stopped according to the room temperature which heating operation is started. Wait for approx. 2 to 3 minute, and the operation will be automatically changed to the ordinary heating mode.
- Defrosting operation (in the heating mode):
When it is liable to frost. the heating operation is stopped automatically for 5 to 12 minutes once per approx. one hour, and defrosting is operated. After defrosting is completed, operation mode is automatically changed to ordinary heating operation.
- When the room thermostat is actuated:
When room temperature increases and room temperature controller actuates, the fan speed is automatically changed to stop under low temperature condition of indoor heat exchanger. When room temperature decreases, air conditioner automatically changes over to ordinary heating operation.



WARMING OPERATION



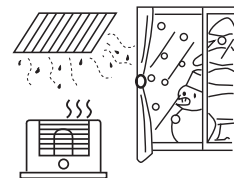

- Heat pump type warming
With the heat pump type warming, the mechanism of heat pump that concentrate heat of outdoor air with the help of refrigerant to warm the indoor space, is utilized.
- Defrosting operation
When a room is warmed with a heat pump type air conditioner, frost accumulates on the heat exchanger of outdoor unit along with the drop of indoor temperature. Since the accumulated frost reduces the effect of warming, it is necessary to automatically switch the operation to the defrosting mode. During the defrosting operation, heating operation is interrupted.
- Atmospheric temperature and warming capacity
Warming capacity of heat pump type air conditioner decreases along with the drop of outdoor temperature.
When the warming capacity is not sufficient, it is recommended to use another heating implement.
- Period of warm-up
Since the heat pump type air conditioner employs a method to circulate warm winds to warm the entire space of a room, it takes time before the room temperature rises.
It is recommendable to start the operation a little earlier in a very cold morning.



■ INSTALLATION MANUAL FOR OUTDOOR UNIT

Confirm the following items for safe and comfortable use of air conditioner.

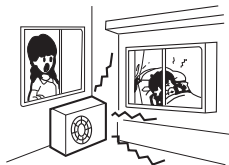
The installation work is to be burden on the sales dealer, and do not conduct it by yourself.

Installation place		
<p>Avoid installing the air conditioner near the place where possibility of inflammable gas leakage exists.</p>  <p>Explosion (Ignition) may occur.</p>	<p>Install the unit at well ventilated place.</p>  <p>If some obstacle exist, it may cause capacity reduction or noise increase.</p>	<p>Install the air conditioner firmly on the foundation that can fully support the weight of the unit.</p>  <p>If not, it may cause vibration or noise.</p>
<p>Select the place so as not to annoy neighbor with the hot air or noise.</p>  	<p>Snow protection work is necessary where outdoor unit is blocked up by snow.</p> <p>For details consult your sales dealer.</p>	<p>It is advisable not to install the air conditioner at the following special place. It may cause malfunction, consult the sales dealer when you have to install the unit on such a place.</p> <ul style="list-style-type: none"> ● The place where corrosive gas generates (Hot spring area etc.) ● The place where salt breeze blows (Seaside etc.) ● The place where dense soot smoke exists ● The place where humidity is extraordinarily high ● The place where near the machine which radiates the electromagnetic wave ● The place where voltage variation is considerably large

Electric work

The electric work must be burden on the authorized engineer with qualification for electric work and grounding work, and the work must be conducted in accordance with electric equipment technical standard.

- The power source for the unit is to be of exclusive use.
- An earth leakage breaker should be installed.(This is necessary to prevent electric shock.)
- The unit must be grounded.

When you change your address or the installation place

Special technology is required for removal or reinstallation of air conditioner, consult the sales dealer. Besides, construction expense is charged for removal or reinstallation.

For inspection and maintenance

The capacity of air conditioner will decrease by contamination of inside of unit when it is used for about three years although depending upon the circumstances under which it is used, and so in addition to the usual maintenance service, special inspection/maintenance service is necessary. It is recommended to make a maintenance contract (charged) by consulting your sales dealer.

■ INSTALLATION MANUAL FOR OUTDOOR UNIT

<Heat Pump model/Cooling Only model >

⚠ WARNING

BE SURE TO READ THESE INSTRUCTIONS CAREFULLY BEFORE BEGINNING INSTALLATION. FAILURE TO FOLLOW THESE INSTRUCTIONS COULD CAUSE SERIOUS INJURY OR DEATH, EQUIPMENT MALFUNCTION AND/OR PROPERTY DAMAGE. BE SURE TO READ INSTALLATION MANUAL FOR INDOOR UNIT WITH THIS MANUAL.

1. Accessories

"Edging" for protection of electric wires from an opening edge.

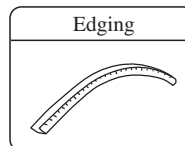

2. Selection of the place of installation

Select the place of installation satisfying the following conditions and, at the same time, obtain a consent from the client or user.

- Place where air circulates.
- Place free from heat radiation from other heat sources.
- Place where drain water may be discharged.
- Place where noise and hot air may not disturb the neighborhood.
- Place where there is not heavy snowfall in the winter time.
- Place where obstacles do not exist near the air inlet and air outlet .
- Place where the air outlet may not be exposed to a strong wind.
- Place surrounded at four sides are not suitable for installation. A 1m or more of overhead space is needed for the unit.
- Mount guide-louvers to place where short-circuit is a possibility.
- When installing several units, secure sufficient suction space to avoid short circuiting.

(1) Open space requirement around the unit

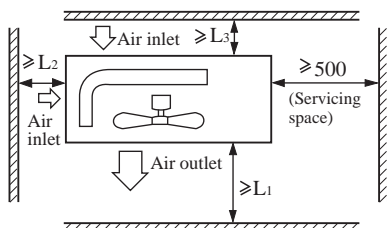

Unit: mm

Distance	Case	I	II	III
L1		open	open	500
L2		300	0	open
L3		150	300	150

(2) Installation where the area with strong winds.

Install the unit so that the air outlet section of the unit must NOT be faced toward wind direction.

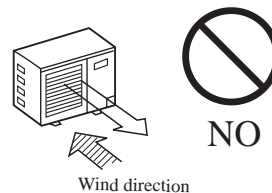

3. Installation of outdoor unit

(1) Installation

Fix the unit in a proper way according to the condition of a place where it is installed by referring to the following .

(a) Concrete foundation

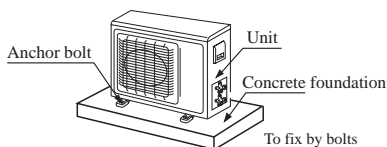

Note (1) Give enough room for the concrete foundation to fix by anchor bolts.

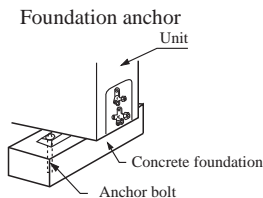

Note (1) Place the concrete foundation deep enough.

- Install the unit so that the angle of inclination must be less than 3 degrees.

■ INSTALLATION MANUAL FOR OUTDOOR UNIT

4. Refrigerant piping

(1) Outline piping

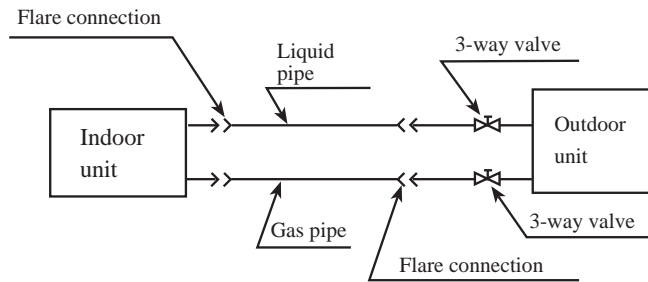

(2) Piping size

Liquid pipe	φ 9.52x0.8mm
Gas pipe	φ 15.88x1.0mm

- Install the removed flared nuts to the pipes to be connected, then flare the pipes.

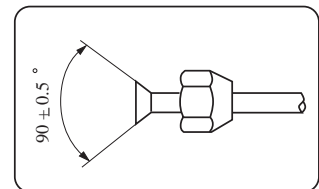

(3) Limitations for one way piping length and vertical height difference.

- One way piping length: less than 15m.
- Vertical height difference: Less than 5m.

Precautions for refrigerant piping

- Do not twist or crush piping.
- Be sure that no dust is mixed in piping.
- Bend piping with as wide angle as possible.
- Keep insulating both gas and liquid piping.
- Check flare-connected area for gas leakage.

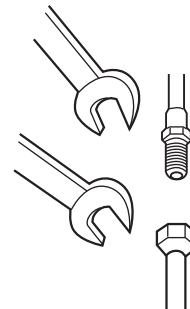

(4) Piping connection

- Connecting method

Apply refrigerant oil at half union and flare nut.

To bend a pipe, give the roundness as large as possible not to crash the pipe.

When connecting pipe, hold the pipe centre to centre then screw nut on by hand, refer to Fig.

Be careful not to let foreign matters, such as sands enter the pipe.

Forced fastening without centering may damage the threads and cause a gas leakage.

Pipe dia	Fastening torque
Liquid pipe 9.52mm(3/8")	42N·m
Gas pipe 15.88mm(5/8")	60N·m

INSTALLATION MANUAL FOR OUTDOOR UNIT

(5) Purging method (the refrigerant is R407C)

To use vacuum pump

① Detach the service port's cap of 3-way valve, the valve rod's cap for 3-way valve and 3-way's, connect the service port into the projection of charge hose (low) for gaugemanifold. Then connect the projection of charge hose (center) for gaugemanifold into vacuum pump.

② Open the handle at low in gaugemanifold, operate vacuum pump. If the scale-moves of gauge (low) reach vacuum condition in a moment, check ① again.

③ Vacuumize for over 15min. And check the level gauge which should read -0.1 MPa (-76 cm Hg) at low pressure side. After the completion of vacuumizing, close the handle 'Lo' in gaugemanifold and stop the operation of the vacuum pump. Check the condition of the scale and hold it for 1-2min. If the scale-moves back in spite of tightening, make flaring work again, the return to the beginning of ③.

④ Open the valve rod for the 3-way valve to and angle of anticlockwise 90 degree. After 6 seconds later, close the 3-way valve and male the inspection of gas leakage.

⑤ No gas leakage?

In case of gas leakage, tighten parts of pipe connection. If leakage stops, then proceed ⑥

If it does not stop gas leakage, discharge whole refrigerants from the serice port. After flaring work again and vacuumize, fill up prescribed refrigerant from the gas cylinder.

⑥ Detach the charge hose from the service port, open 3-way valve and 3-way. Turn the valve rod anticlockwise until hitting lightly.

⑦ To prevent the gas leakage, turn the service port's cap, the valve rod'd cap for 3-way valve and 3-way's a lottle more than the point where the torque increases suddenly.

⑧ After attaching the each caps, check the gas leakage around the caps.

CAUTION:
If the refrigerant of the air conditioner leaks, it is necessary to make all the refrigerant out, then charge the liquid refrigerant into air conditioner according to the amount marked on the name plate.

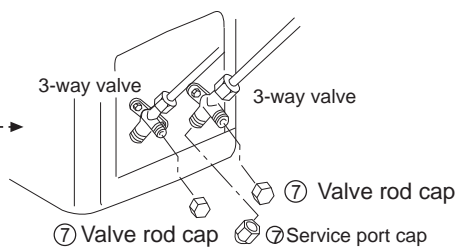
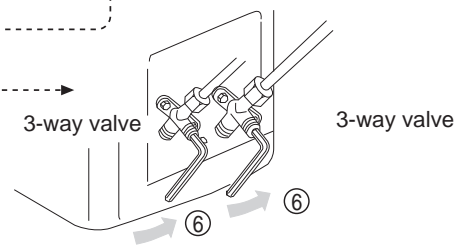
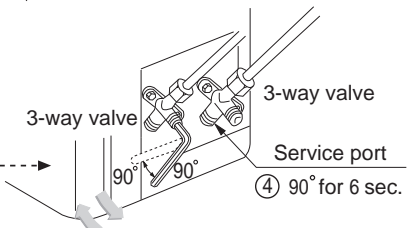
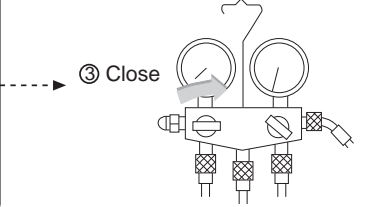
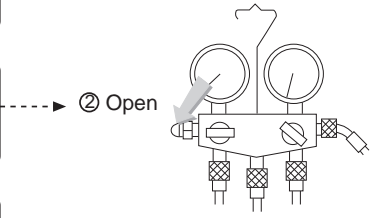
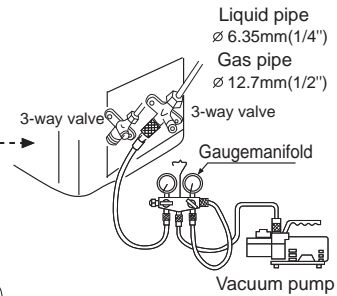

■ INSTALLATION MANUAL FOR INDOOR UNIT

1. Safety precautions

- Please read these "Safety Precautions" first then accurately execute the installation work.
- Though the precautionary points indicated herein are divided under two headings, **⚠ WARNING** and **⚠ CAUTION**, those points which are related to the strong possibility of an installation done in error resulting in death or serious injury are listed in the **⚠ WARNING** section. However, there is also a possibility of serious consequences in relationship to the points listed in the **⚠ CAUTION** section as well. In either case, important safety related information is indicated, so by all means, properly observe all that is mentioned.
- After completing the installation, along with confirming that no abnormalities were seen from the operation tests, please explain operating methods as well as maintenance methods to the user (customer) of this equipment, based on the owner's manual.
Moreover, ask the customer to keep this sheet together with the owner's manual.

⚠ WARNING

- This system should be applied to places as office, restaurant, residence and the like. Application to inferior environment such as engineering shop could cause equipment malfunction.
- Please entrust installation to either the company which sold you the equipment or to a professional contractor. Defects from improper installations can be the cause of water leakage, electric shocks and fires.
- Execute the installation accurately, based on following the installation manual. Again, improper installations can result in water leakage, electric shocks and fires.
- When a large air-conditioning system is installed to a small room, it is necessary to have a prior planned countermeasure for the rare case of a refrigerant leakage, to prevent the exceeding of threshold concentration. In regards to preparing this countermeasure, consult with the company from which you purchased the equipment, and make the installation accordingly. In the rare event that a refrigerant leakage and exceeding of threshold concentration does occur, there is the danger of a resultant oxygen deficiency accident.
- For installation, confirm that the installation site can sufficiently support heavy weight. When strength is insufficient, injury can result from a falling of the unit.
- Execute the prescribed installation construction to prepare for earthquakes and the strong winds of typhoons and hurricanes, etc. Improper installations can result in accidents due to a violent falling over of the unit.
- For electrical work, please see that a licensed electrician executes the work while following the safety standards related to electrical equipment, and local regulations as well as the installation instructions, and that only exclusive use circuits are used.
Insufficient power source circuit capacity and defective installation execution can be the cause of electric shocks and fires.
- Accurately connect wiring using the proper cable, and insure that the external force of the cable is not conducted to the terminal connection part, through properly securing it. Improper connection or securing can result in heat generation or fire.
- Take care that wiring does not rise upward, and accurately install the lid/service panel. Its improper installation can also result in heat generation or fire.
- When setting up or moving the location of the air conditioner, do not mix air etc. or anything other than the designated refrigerant (R407C) within the refrigeration cycle.
Rupture and injury caused by abnormal high pressure can result from such mixing.
- Always use accessory parts and authorized parts for installation construction. Using parts not authorized by this company can result in water leakage, electric shock, fire and refrigerant leakage.

⚠ CAUTION

- Execute proper grounding. Do not connect the ground wire to a gas pipe, water pipe, lightning rod or a telephone ground wire. Improper placement of ground wires can result in electric shock.
- The installation of an earth leakage breaker is necessary depending on the established location of the unit. Not installing an earth leakage breaker may result in electric shock.
- Do not install the unit where there is a concern about leakage of combustible gas.
The rare event of leaked gas collecting around the unit could result in an outbreak of fire.
- For the drain pipe, follow the installation manual to insure that it allows proper drainage and thermally insulate it to prevent condensation. Inadequate plumbing can result in water leakage and water damage to interior items.

INSTALLATION MANUAL FOR INDOOR UNIT

⚠ NOTICE

All Wiring of this installation must comply with NATIONAL, STATE AND LOCAL REGULATIONS. These instructions do not cover all variations for every kind of installation circumstance. Should further information be desired or should particular problems occur, the matter should be referred to your local distributor.

⚠ WARNING

BE SURE TO READ THESE INSTRUCTIONS CAREFULLY BEFORE BEGINNING INSTALLATION. FAILURE TO FOLLOW THESE INSTRUCTIONS COULD CAUSE SERIOUS INJURY OR DEATH, EQUIPMENT MALFUNCTION AND/OR PROPERTY DAMAGE.

(1) Preparation of indoor unit

Before or during the installation of the unit, assemble necessary optional panel etc. depending on the specific type.

(2) Select places for installation satisfying following conditions and at the same time obtain the consent on the part of your client user.

(a) Places where chilled or heated air circulates freely.

When the installation height exceeds 3m warmed air stays close to the ceiling. In such cases, suggest our client users to install air circulators.

(b) Places where perfect drainage can be prepared and sufficient drainage.

(c) Places free from air disturbances to the suction port and blowout hole of the indoor unit, places where the fire alarm may not malfunction or short-circuit.

(d) Places with the environmental dew-point temperature is lower than 28°C and the relative humidity is less than 80%.

(When installing at a place under a high humidity environment, pay sufficient attention to the prevention of dewing such as thermal insulation of the unit.)

(e) Ceiling height shall have the following height.

Combination with silent panel	366mm
-------------------------------	-------

● Installation space

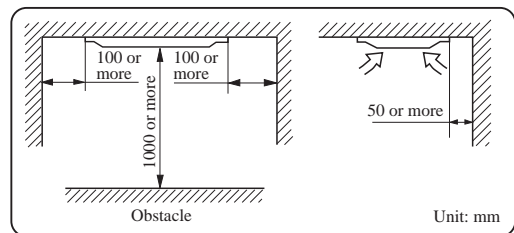

(3) Avoid installation and use at those places listed below.

(a) Places exposed to oil splashes or steam (e.g. kitchens and machine plants).

Installation and use at such places incur deteriorations in the performance or corrosion with the heat exchanger or damage in molded synthetic resin parts.

(b) Places where corrosive gas (such as sulfurous acid gas) or inflammable gas (thinner, gasoline, etc) in generated or remains. Installation and use at such places cause corrosion in the heat exchanger and damage in molded synthetic resin parts.

(c) Places adjacent to equipment generating electromagnetic waves or high-frequency waves such as in hospitals.

Generated noise may cause malfunctioning of the controller.

INSTALLATION MANUAL FOR INDOOR UNIT

(4) Preparation for suspending the unit

(a) Figure of installation dimension: (unit: mm)

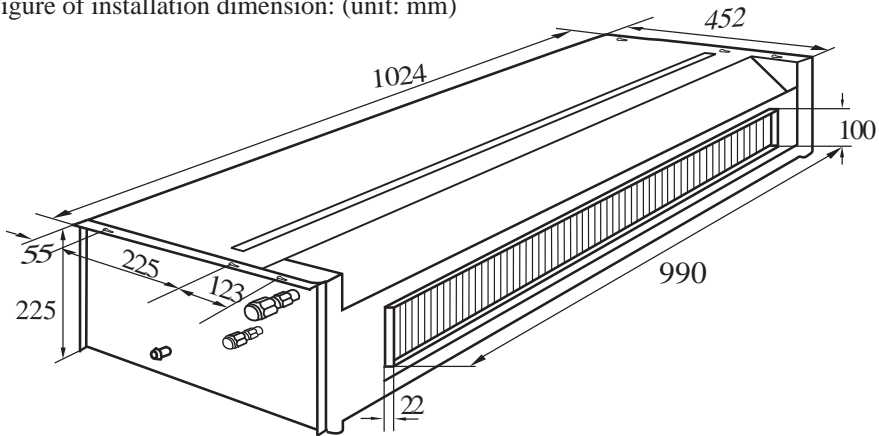

Standard pressure 0 Pa , Middle pressure 50Pa

- When install the duct hidden type indoor unit, the return air box must be designed and installed, as Figure3, Figure4.
- The distance between the air outlet of duct and the air outlet of air conditioner should be no more than 1m.
- The distance between the air outlet of duct and the air outlet of air conditioner should be no more than 1.0m(use white motor plug);
The distance between the air outlet of duct and the air outlet of air conditioner should be no more than 5.0m(use red motor plug).

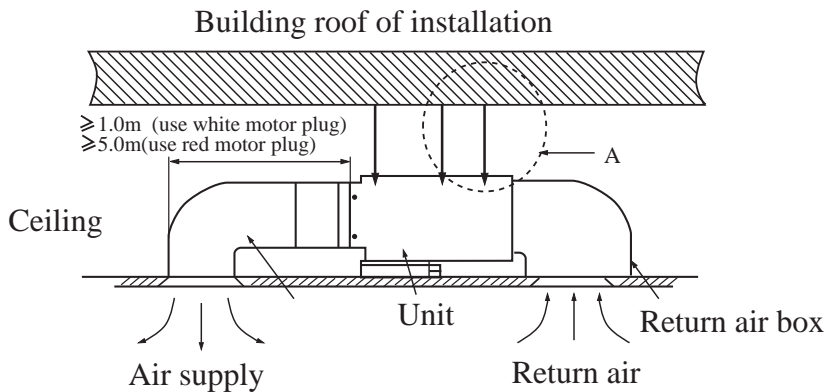

(Figure 3)

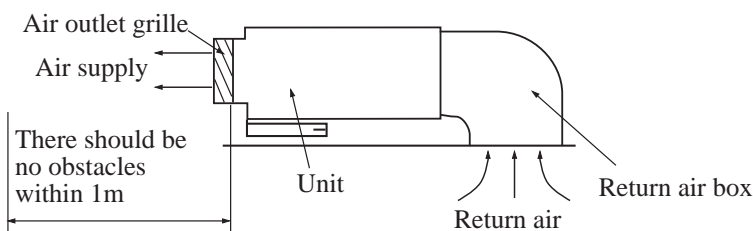

(Figure 4)

INSTALLATION MANUAL FOR INDOOR UNIT

M8 wide expansion screw bolt

A amplified

(Figure 5)

M8 hoisting screw
M8 wide lock washer
M8 screw nut

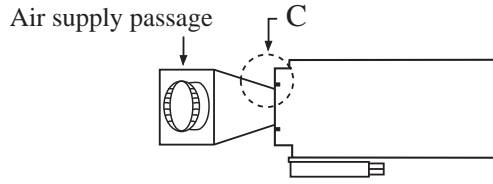
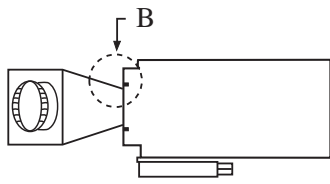
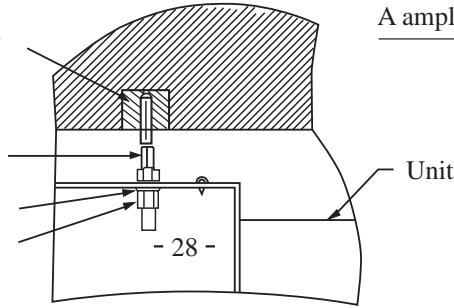

(Figure 6)

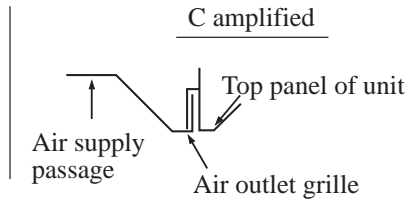
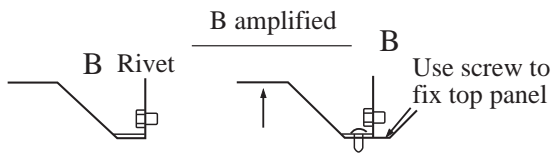

Install the hoisting screw

Use M8 or M10 hoisting screw (4, prepare on site) (When the height of hoisting screw is more than 0.9m, you must use M10), their gaps refer to the dimension of air conditioner, according to the original structure and the following method to install.

Wood structure

Put up the frame wood on the beam and mount the hoisting screws.

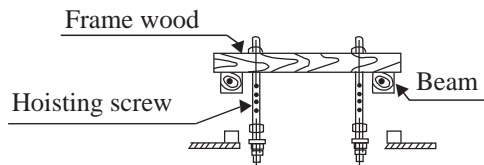

New cement panel

Use embedded parts and foot screw, etc to mount.



(Knife type embedded part)



(Louver type embedded part)



(hoisting foot screw for connection pipe)

INSTALLATION MANUAL FOR INDOOR UNIT

Original cement panel

Use the in hole hinge, in hole plug or in hole screw.

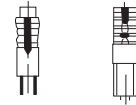

Steel structure

Directly use angle steel or new angle steel for support.

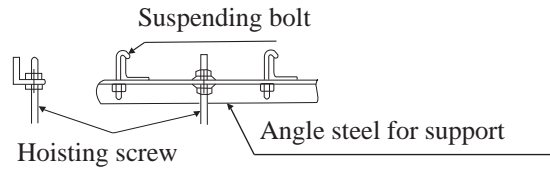

Suspending of indoor unit

- Fix the cap of hoisting screw on and suspend them on the T groove of the hoisting part of the unit.
- Use gradienter to keep the level degree of the unit within 5mm.

⚠ Notice

- In order to normally drain water, the drain hose should be mated according to the installation manual. In order to avoid dew-forming, thermal insulation treatment should be done.
- Improper connection pipe may cause water enter indoor.

Requirements:

- The indoor side drain hose should be thermal insulated.
- The parts connected with indoor unit should be thermal insulated. Improper thermal insulation may cause dew-forming phenomenon.
- The drain hose should be downwards slant (over 1/100) and there should be no S-shaped bend.
- Otherwise, abnormal sound may occur.
- The horizontal length of the drain hose should be less than 20m. If the connection pipe is too long, the supporting frame should be set every 1.5~2m to prevent pipe from rise and fall.
- For the centralized connection pipe, please perform work as the following Figure shown. Pay attention not to exerting external force to the connection part of the drain hose.

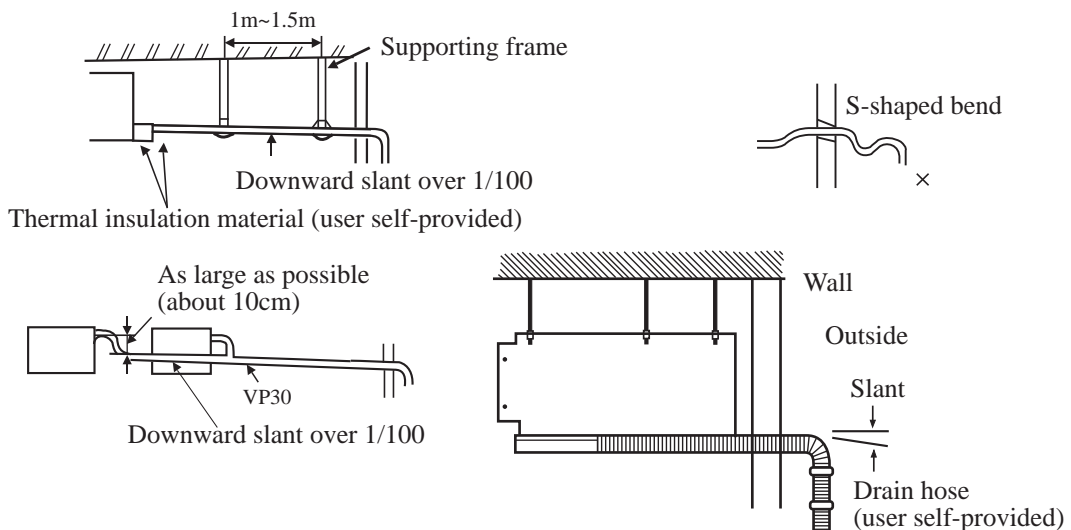

■ INSTALLATION MANUAL FOR INDOOR UNIT

Material of connection pipe and thermal insulation

Material of connection pipe	Stiff PVC pipe VP 20mm (inside diameter)
Material of thermal insulation	Foam polyethylene pipe, thickness over 10mm

Confirm drainage

Perform test run to insure the condition of drainage, the connection part of the connection should not leak water. The confirmation must be performed even if install in winter.

⚠ Warning

- During installation, if refrigerant leakage occurs, please immediately take ventilation measure. If the refrigerant gas meet the fire, it may generate poisonous gas.
- After finishing installation work, please make sure there is no refrigerant leakage. If the leaked refrigerant gas meet heater and oven, etc. fire sources, it may generate poisonous.

Material and dimension of connection pipe

Depenbing on the outdoor unit.For details,please refer to the operation manual attached with outdoor unit.

The permitted length and fall of connection pipe

Material of connection pipe	Phosphorus oxidized copper seamless pipe (TP2) for air conditioner	
Dimension of connection pipe	Gas side	∅ 15.88
	Liquid side	∅ 9.52

Connection of refrigerant pipe

When performing the connection work of flare nut, connect all the refrigerant pipe.

- When connecting the connection pipe of indoor unit, must use two spanners to perform.
- For the installation torque, please refer the following Table.

Perform with two spanners

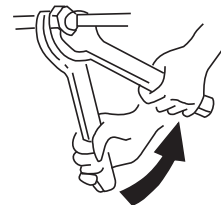

External diameter of connection pipe (mm)	Installation torque (N.m)	Add to installation torque (N.m)
∅ 9.52	24.5(2.5kgf.m)	29.4(3.0kgf.m)
∅ 15.88	78.4(8.0kgf.m)	98.0(10.0kgf.m)

■ INSTALLATION MANUAL FOR ELECTRIC WIRING

5. Electric wiring

Cautions: Use copper wire only. Parameters of connecting line : H05RN-F 4G0.75mm² ; Parameters of power supply line : H07RN-F 3G2.5mm².
Power supply : 1PH,220-230V~,50Hz, connect from outside.

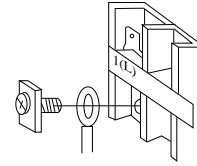

Wiring method of ring terminal

Wiring methods:

1. Wiring method of ring terminal

For connecting line which end is a ring, its wiring method as shown in the right figure: remove wiring screw and pass it through the end ring of connecting line, then connect it to the terminal block and tighten screw.

2. Wiring method of straight terminal

For connecting line which end is not a ring, its wiring method as follows: loosen wiring screw and insert the end of connecting line totally into the terminal block, then tighten the screw and pull the connecting line slightly to confirm that it is clamped firmly.

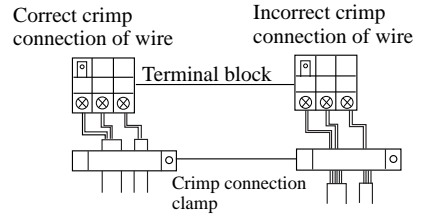

Crimp connection method of connecting line

After finishing wiring, connecting line must be fastened by wire clamp, which is pressed on the external sheath of the connecting line, as shown in the right figure:

Wiring of indoor unit

- Open air inlet grill
- Take the leading end of connecting line
- Connect connecting line according to wiring methods and wiring diagram of indoor and outdoor unit
- Fasten connecting line according to crimp connection method of connecting line.
- Reinstall air inlet grill.

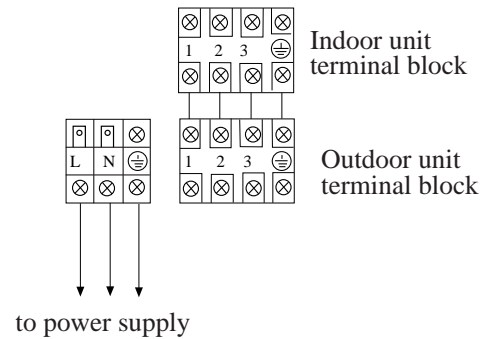

1. Installation fixing

Fix outdoor unit on the installation bracket firmly using bot(M10) and nut, and keep it on horizontal level. When installing on the wall or on the roof, fix the bracket, firmly to prevent earthquake or storm. Be sure to use rubber-damping cushion to reduce unit vibration.

2. Installation of drain elbow

Installation of drain elbow. (Only for heat pump type air conditioner, no drain elbow for single cooling type). If use drain elbow, please install as shown in the figure. Do not use drain elbow in cold place (temperature successively below 0°C)

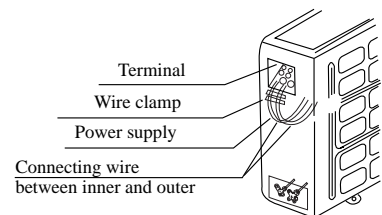

3. Connection of outdoor piping

Connect the connecting pipe according to the piping connection method

4. Wiring connection

1. Open the wiring cover and loosen the wiring clamp.
2. Lead the connecting wire out and pass it through the wiring clamp.
3. Connect the connecting wire according to the wiring method and diagram
4. Confirm the ends of wire are connected well, safe and correct.
5. After finishing wiring, press the connecting wire according to the wire crimp connection method and reinstall the cover.

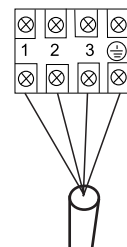

■ INSTALLATION MANUAL FOR WIRE CONTROLLER

1. Remove the upper cover of wire controller

The PC board is installed on the back cover of wire controller. When remove the upper cover, pay attention not to damage PC board.

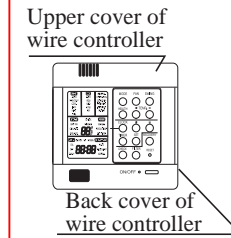

2. Install wire controller

- **Drill 2 wall holes according to the position of the 2 screw holes on the back cover of wire controller, then hit wood in the wall holes. Put the 2 screw holes on the back cover of wire controller properly to its corresponding wood, then
- *use wood screws to fix the back cover on the wall.

Note:

Install the back cover of wire controller on the even wall as possible as can. When tightening the wood screw, do not use to tight force, otherwise the wire controller may be damaged.

Note:

When connecting wire, please keep a certain distance between signal wire and electric wire. (over 10mm)

Dimension of signal wire:

Type of wire	Shield wire (4 cords)
Dimension	0.33mm ²

3. Indoor unit wire connection

Connect the terminals (A, B, C, D,) on the wire controller to the terminals on the indoor PC panel (A, B, C, D,) respectively.

Arrange wire from this part

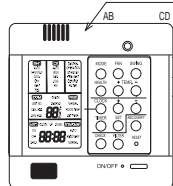

Back cover wire controller

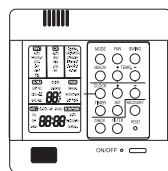

Upper cover of wire controller

The connection between indoor unit and wire controller and indoor unit and outdoor unit should use shield wire. And the two ends of the shield wire should be grounded, otherwise, the disturbance will cause unit abnormal operation.

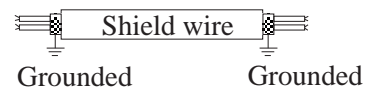

Note:

Confirm the connection part of terminals is firm and will not touch shield wire.

4. Cover the wire controller upper cover

Pay attention not to press the connection wire.

Note: Do not touch PC board by hand.

CHECK AND TEST RUN

Other instruction

1. Set of the air sending of the fan motor

Before leaving factory, the rotation speed of fan motor has already been set at standard choice. When the indoor unit uses free air sending and not needing to connect with duct, the fan speed of indoor unit is set at standard choice. When the indoor unit needs to connect with duct, please according to the following figure shown to change the connection of the connector installed on the side of electric box.

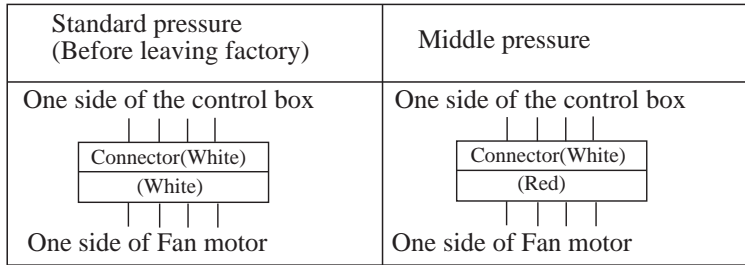

Unit: Pa

The relative relation between fan speed and static pressure

2. Cut and flaring method





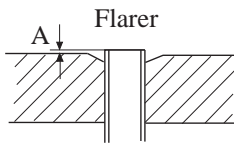

Use pipe cutter to cut the pipe, the burrs must be removed. After inserting the flarer, perform flared nut.

Standard pressure
0
Middle pressure
50



Flaring dimensions as follows:

Connent pipe	Pipe diameter	Dimension A (mm)
Liquid pipe	9.52mm (3/8")	1.0-1.2
Gas pipe	15.88mm (5/8")	1.4-2.2

Correct	Incorr					
						
	Slant	Broken	Burrs	Uncompleted	Too long	

3. Configuration of power supply

- Air conditioner must use special power supply system (above 20A), and qualified electrician makes wiring and fixing according to wiring regulations specified in national standard.
- In socket, exactly distinguish earth wire with neutral wire and it is wrong to connect them together.
- A leakage breaker must be installed.
- Parameters of power supply: H07RN-F 3G 2.5mm²
- Connection method is Y-connection. If the power cord is damaged, it must be replaced by professional people of manufacturer or its maintenance department or similar to avoid dangers.

4. Installation check and test run

Require customers to use air conditioner according to the operation manual.

The items checked during test run, please mark in

- | | |
|---|---|
| <input type="checkbox"/> Is the wiring of indoor and outdoor unit secured firmly? | <input type="checkbox"/> No gas leakage on the pipe joint ? |
| <input type="checkbox"/> How about the thermal insulation of the pipe joint: | <input type="checkbox"/> Is the drainage hose arranged correct? |
| <input type="checkbox"/> Is the electrical wiring between indoor and outdoor unit connected to the terminal block firmly? | <input type="checkbox"/> Is the earthing wire connected firmly? |
| <input type="checkbox"/> Is the display on the control board (LCD) correct? | <input type="checkbox"/> Any noise? |
| <input type="checkbox"/> Cooling normal? | <input type="checkbox"/> For the power supply |
| <input type="checkbox"/> Does the indoor temperature regulator work normally? | 1 shall be connected to the live wire. |
| <input type="checkbox"/> Is the power supply voltage conformed to the electrical regulation? | 2 shall be connected to the neutral wire. |
| | ⊕ Shall be connected to the earth wire. |