

Compact Hi-Fi Stereo System

Operating Instructions



LBT-D117CD

Warning

Owner's Record

The model and serial numbers are located at the rear. Record these numbers in the space provided below. Refer to these numbers whenever you call upon your Sony dealer regarding this product.

Model No. LBT-D117CD Serial No. _____

To prevent fire or shock hazard, do not expose the unit to rain or moisture.

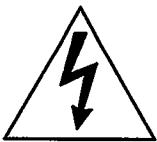
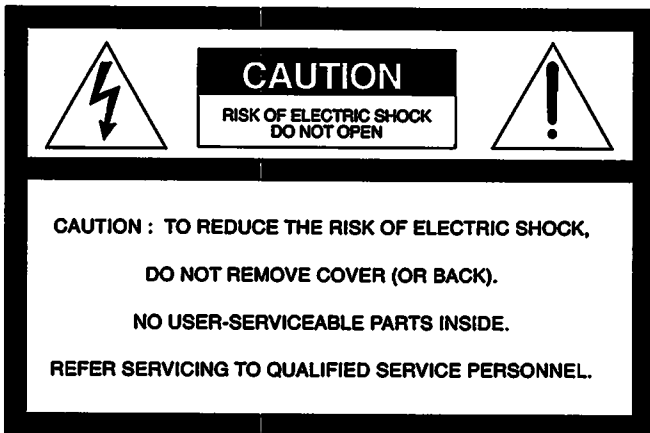

This symbol is intended to alert the user to the presence of uninsulated "dangerous voltage" within the product's enclosure that may be of sufficient magnitude to constitute a risk of electric shock to persons.



This symbol is intended to alert the user to the presence of important operating and maintenance (servicing) instructions in the literature accompanying the appliance.

For the customers in Canada

CAUTION:
TO PREVENT ELECTRIC SHOCK, DO NOT USE THIS POLARIZED AC PLUG WITH AN EXTENSION CORD, RECEPTACLE OR OTHER OUTLET UNLESS THE BLADES CAN BE FULLY INSERTED TO PREVENT BLADE EXPOSURE.

THIS APPARATUS COMPLIES WITH THE CLASS B LIMITS FOR RADIO NOISE EMISSIONS SET OUT IN RADIO INTERFERENCE REGULATIONS.

INFORMATION

This equipment generates and uses radio frequency energy and if not installed and used properly, that is, in strict accordance with the manufacturer's instructions, may cause interference to radio and television reception. It has been type tested and found to comply with the limits for a Class B computing device on accordance with the specifications in Subpart J of Part 15 of FCC Rules, which are designed to provide reasonable protection against such interference in a residential installation. However, there is no guarantee that interference will not occur in a particular installation. If this equipment does cause interference to radio or television reception, which can be determined by turning the equipment off and on, the user is encouraged to try to correct the interference by one or more of the following measures:

Relocate the receiving antenna

Relocate the equipment with respect to the receiver

Move the equipment away from the receiver

Plug the equipment into a different outlet so that equipment and receiver are on different branch circuits.

If necessary, the user should consult the dealer or an experienced radio/television technician for additional suggestions. The user may find the following booklet prepared by the Federal Communications Commission helpful:

"How to Identify and Resolve Radio-TV Interference Problems". This booklet is available from the U.S. Government Printing Office, Washington, DC 20402, Stock No. 004-000-00345-4.

Note to CATV system installer:

This reminder is provided to call the CATV system installer's attention to Article 820-40 of the NEC that provides guidelines for proper grounding and, in particular, specifies that the cable ground shall be connected to the grounding system of the building, as close to the point of cable entry as practical.

Configuration

This manual covers the system in the chart below. The system number is shown on the carton box.

	LBT-D117CD
Compact disc deck receiver	HCD-D117
Speakers	SS-D117

In the instructions starting from page 16, buttons on the remote commander are indicated in parentheses, unless mentioned otherwise.

Table of Contents

Getting Started

Configuration	2
Precautions	3
Preparations	3
Connections	4

Using Your Stereo

Turning on the power	6
Basic sound adjustments	6
Receiving broadcasts	8
Playing back tapes	10
Recording on tapes	11
Dubbing tapes	13
Playing compact discs	14
Playing in a random order	17
Playing in a desired order and time	18
Playing the beginning of each selection	19
Playing repeatedly	20
Recording the program	21
Designating the total playing time	22
Tips on editing tapes	24

General

Maintenance	26
Specifications	27
Troubleshooting guide	28
Location of controls	30

Precautions

Before operating the system, read the following precautions carefully

- Operate the unit only on 120 V AC, 60 Hz.
- Unplug the system from the wall outlet if it is not to be used for an extended period of time. To disconnect the cord, pull it out by grasping the plug. Never pull the cord itself.
- Should any solid object or liquid fall into the unit, unplug the unit and have it checked by qualified personnel before any further operation.
- The nameplate indicating operation voltage, power consumption, etc. is located at the rear.
- As the laser beam use in this unit is harmful to the eyes, do not attempt to disassemble the cabinet. Refer servicing to qualified personnel only.
- AC power cord must be changed at a qualified service shop.

If you have any questions or problems concerning your system, please consult your nearest Sony dealer.

For detailed precautions, see the leaflet "IMPORTANT SAFEGUARDS".

Preparations

You can control the system (except the cassette deck) with the supplied remote commander.

Remote Commander

Insert two size AA (R6) batteries with the correct polarity.

- 1** Slide the cover in the direction of the arrow to remove it.

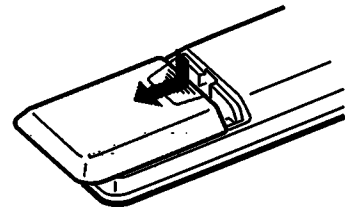

- 2** Insert two size AA (R6) batteries correctly so that the + and - polarities match the polarity diagrams inside the battery compartment.

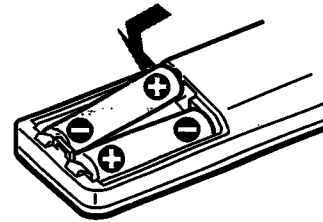

Battery life

About half a year of normal operation can be expected when using Sony SUM-3 (NS) batteries.

When the batteries are exhausted, the commander can no longer operate the unit. Replace both batteries with new ones.

To avoid battery leakage

When the commander is not to be used for a long period of time, remove the batteries to avoid damage caused by battery leakage and corrosion.

To avoid malfunction of the remote commander, avoid keeping the commander in extremely hot or humid locations.

Connections

Turn all the power off before making any connections.
The diagram below shows the system connection.
The letters in the diagram correspond to those in the text.

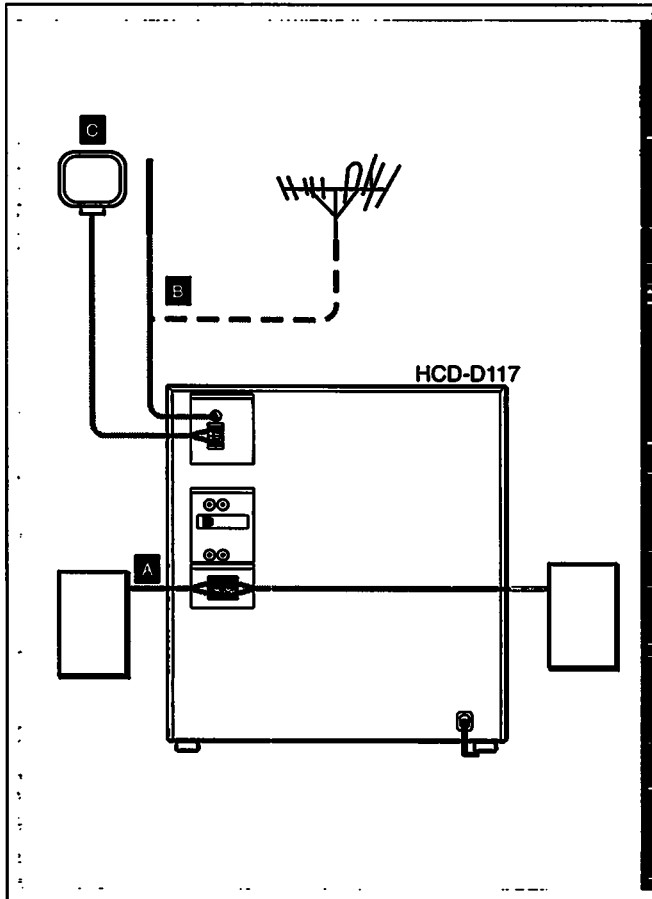

How to attach a wire to the terminal

1 Press down on the button.



2 Insert the wire.



3 Push up the button.

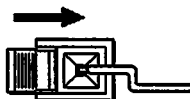

Notes on Connection

- Connect the AC power cord last.
- Cord plugs and jacks are color coded. Red plugs and jacks are for the right channel (R) and white ones are for the left channel (L).

Speaker Cord Connection **A**

- 1 Strip 15 mm of the speaker cord coating from the end of the cord.
- 2 Connect the right speaker to the R (right) speaker terminal, and the left speaker to the L (left) speaker terminal.

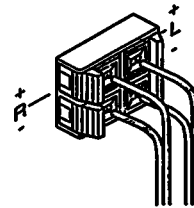

FM Antenna Connection **B**

Connect the supplied FM wire antenna to the FM 75 Ω terminal and extend horizontally.

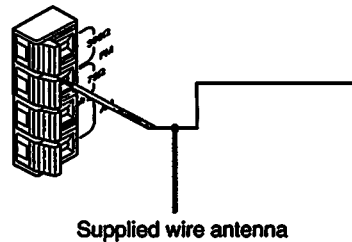

For better reception
Connect to an outdoor antenna.

AM Antenna Connection

C

Connect the supplied loop antenna to the AM and μ terminals.

You can attach the loop antenna on the wall using the commercially available screws.

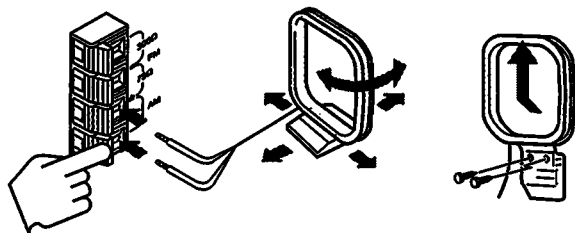

For better reception

Connect an insulated wire of 6 to 15 meters (20- to 50- feet) to the AM terminal.

Adding Another Component to the System

You can connect a VCR to the VIDEO jacks respectively. To select the VCR, press the VIDEO button.

AC Power Cord

Connect the AC power cord of the HCD-D117 compact disc deck receiver to a wall outlet.

Turning on the Power

Turn on the power after completing all connections.

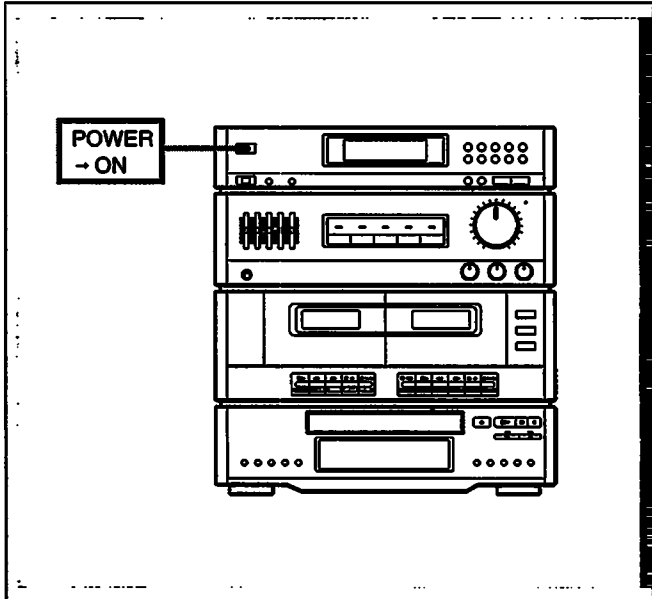

Turn on the compact disc deck receiver.



Basic Sound Adjustments

The following operations apply only to reproduced sound. The letters in the illustration below correspond to those in the text.

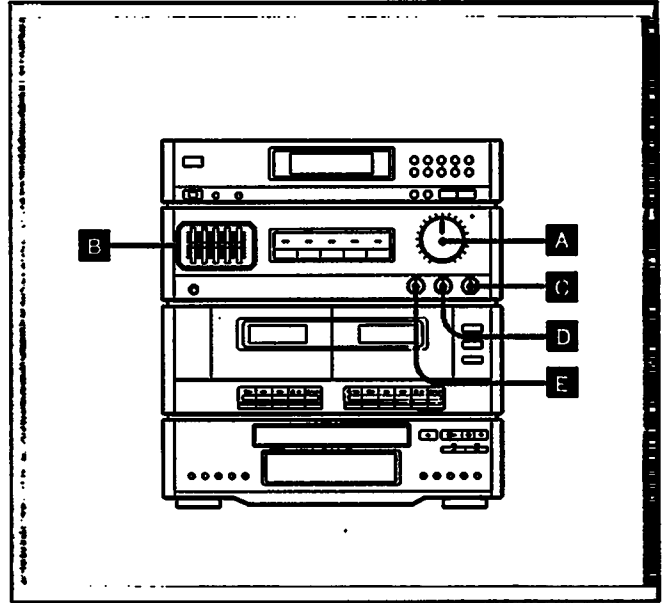

Adjusting the Volume A

To increase the volume, turn the VOLUME control clockwise. To decrease it, turn the control counterclockwise.

- Turn down the volume before switching on the unit. This prevents damage to speakers.

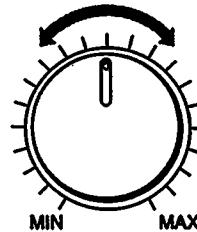

Adjusting the Sound Quality B

Adjust the following 5 BAND GRAPHIC EQUALIZER controls.

100 Hz: Boosts or cuts heavy bass.

330 Hz: Adjusts the power, spaciousness and warmth of the sound.

1 kHz: Accentuates or dims vocals.

3.3 kHz: Boosts to a brighter sound or reduces stridency.

10 kHz: Adjusts tape hiss noise.

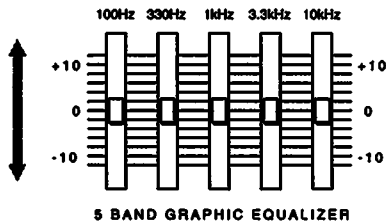

Adjusting the Balance C

When the position of the speakers is not symmetrical, the relative strength of the right and left speaker outputs will be unbalanced.

Adjust the balance with the BALANCE control.



Reinforcing the Bass D

Adjust the DBFB control.

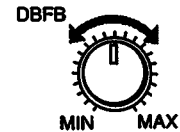

Enjoying the Surround Effect E

Adjust the SURROUND control.

- The surround effect does not function when the sound source is monaural.

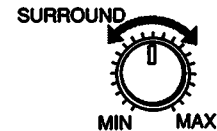

For private listening

Connect a pair of headphones to the HEADPHONES jack.
No sound is heard from the speakers

Receiving Broadcasts

You can listen to FM and AM stations.

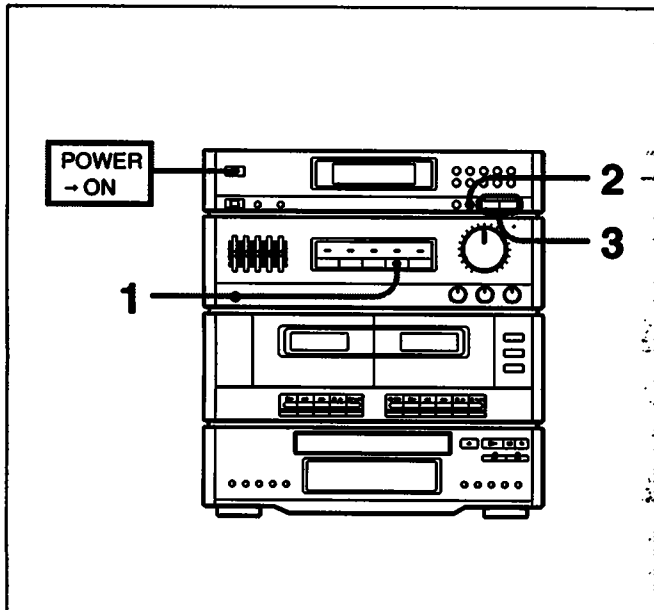

1 Press the **TUNER** button.

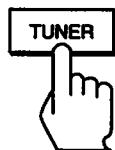

2 Press the **BAND SELECT** button repeatedly until the desired band appears.

BAND SELECT



3 Keep the **DUAL MODE TUNING + or -** button pressed for over 2 seconds so that "AUTO" blinks.

The unit starts scanning frequencies and stops when it tunes into a station. Repeat this step until the desired station is tuned in.

DUAL MODE TUNING

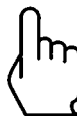

When you press the TUNER button

The CD player is automatically turned off so that radio broadcast may not be disturbed by noise.

For receiving FM stations in stereo

Press the **ST/MUTE** button as many times as "MUTING" appears.

If you cannot tune in a desired station

A station with a weak signal may be skipped. In this case, tune in the station manually.

- Press the **DUAL MODE TUNING + or -** button again to stop scanning.
- Press the **DUAL MODE TUNING + or -** button repeatedly and tune in the exact frequency.

When an FM stereo program is noisy or hard to receive

Press the **ST/MUTE** button so that "MUTING" disappears from the display. There will be no stereo effect, but the reception will be improved. Press it again to restore the stereo effect.

The "TUNED" indication appears

When a station of sufficient signal strength is tuned in.

The "STEREO" indication appears

When an FM stereo program of sufficient signal strength is tuned in.

You can store station frequencies in the unit's memory for quick recall later on. Up to 30 frequencies in any band can be stored by specifying a code for each frequency. The code is a combination of a letter – A, B or C – and a number – 0 to 9: A-1, A-2, ..., A-9, A-0, B-1, ..., C-1, ..., C-0.

Storing Stations

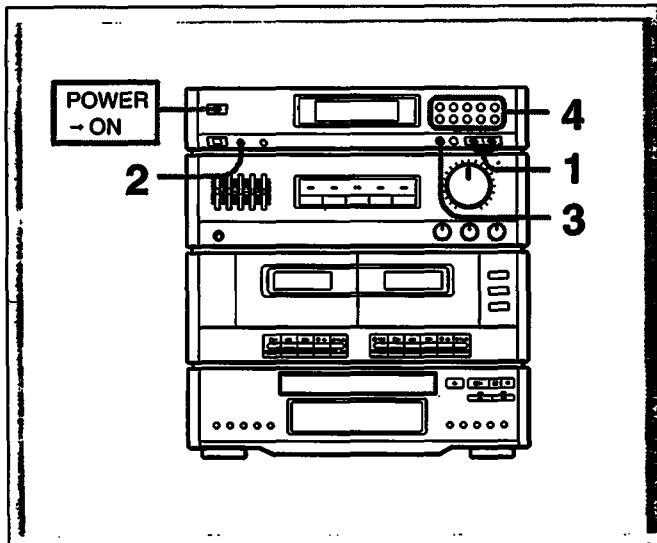

1 Press the DUAL MODE TUNING + or - button to tune in the desired station.

DUAL MODE TUNING

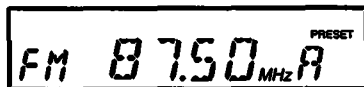

2 Press the MEMORY button. "MEMORY" appears and "-" starts blinking.

MEMORY

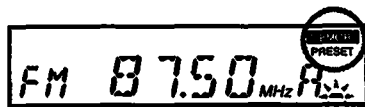

3 Press the SHIFT button to select a letter (A, B or C).

SHIFT

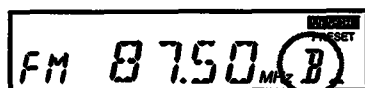

4 Press a numeric button to select a number (0 – 9). A code is specified and the setting of the ST/MUTE button is also stored.

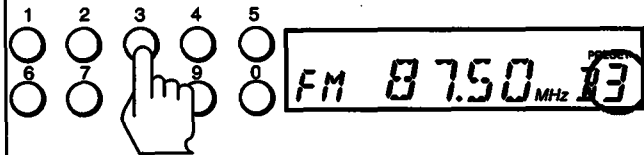

If you cannot store a station successfully
Be sure to press the buttons for the code while the "MEMORY" indication is displayed. If the indication has gone off, press the MEMORY button again.

To erase a stored station

Storing a new station on a used code erases the previously stored one.

Tuning into a Stored Station Directly

Press the SHIFT button and the numeric button to specify the code for the desired station.

Playing Back Tapes

You can use tapes of type I and II for playback.

Playing Deck A or B

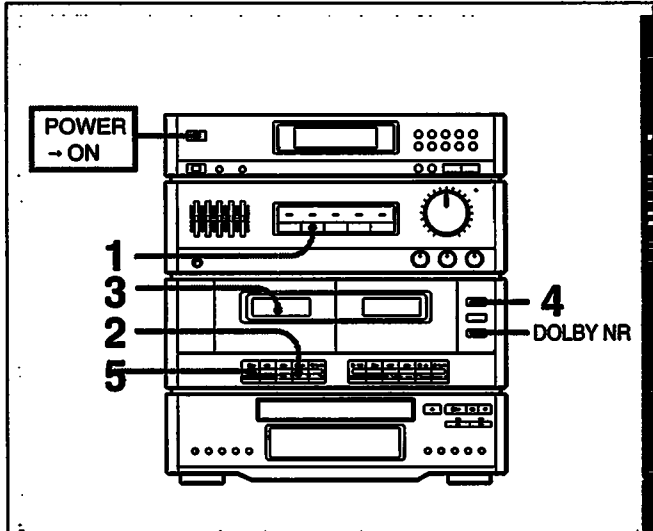

1 Press the TAPE button.



2 Press the  button.



3 Insert a recorded tape.

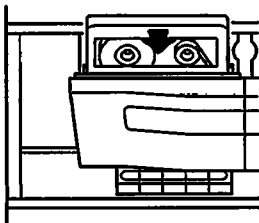



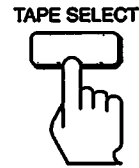



4 Press the TAPE SELECT button to select tape type.



5 Press the  button. Playback starts.



When the tape is played to the end, the deck stops.



To stop during playback, press the   button.
To fast forward or rewind, press the  or  button.
To pause, press the  PAUSE button. To resume, press the  PAUSE button again.

To play a tape recorded with the Dolby NR* effect. Set the DOLBY NR switch to ON. The setting is operated on both decks. This unit is provided with DOLBY B NR system.

When both decks are set to play mode
Only the sound from deck B will be heard.

* Dolby noise reduction manufactured under license from Dolby Laboratories Licensing Corporation.
* DOLBY* and the double-D symbol  are trademarks of Doby Laboratories Licensing Corporation.

Playing from Deck to Deck—Relay Play

- 1 Insert tapes into deck A and B.
- 2 Press the  button on deck B.
Deck B starts playing.
- 3 Press the  PAUSE button and the  button on deck A.

When the tape in deck B ends, the tape in deck A starts playing.

Recording on Tapes

You can use tape type I and II for recording.

Recording a Tape

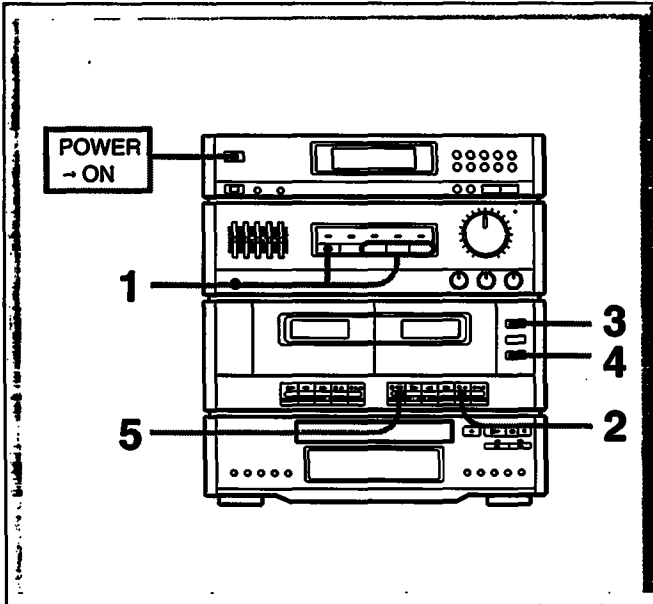

1 Select a source (except TAPE) with the function selectors.

You can also select the audio sources of equipment connected to the VIDEO jacks.

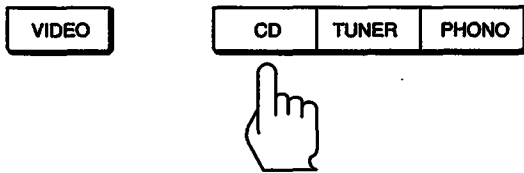

2 Insert a blank tape into deck B.

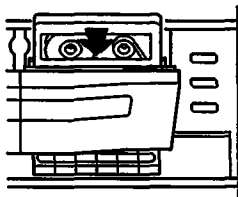

3 Press the TAPE SELECT button to select tape type.



4 Set the DOLBY NR switch to ON or OFF.



The Dolby NR (noise reduction) system reduces tape hiss noise in low-level, high-frequency signals by boosting the signals during recording and then lowering them during playback.

5 Press the ● REC button and start the selected source.

Recording starts.



When the tape is recorded to the end, the deck stops.
To stop during recording, press the ■ ▲ button.

To start recording more precisely

- 1 After steps 1 to 4 above, press the ■ PAUSE button.
- 2 Press the ● REC button.
- 3 Press the ■ PAUSE button again to start recording.

Recording on Tapes

Protecting Your Recording

Break off the tab of the side to be protected. For side A, break off the right-hand tab facing the side A up. This prevents further recording on that side.

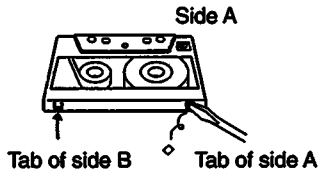

To record on a protected tape, cover the opening with plastic tape.

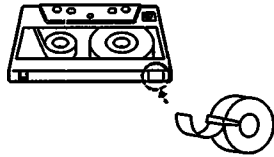

When using type II (CrO₂) tape, take care not to cover the slots used for tape type detection.

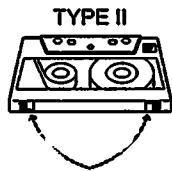

Dubbing Tapes

You can dub a tape in deck A onto a tape in deck B.

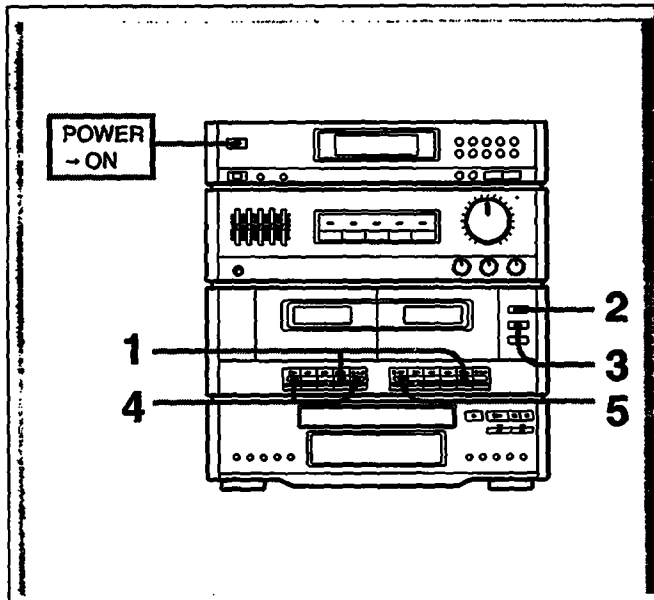

- 1** Insert a recorded tape into deck A and a blank tape into deck B.

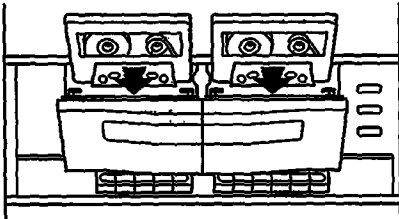

- 2** Press the **TAPE SELECT** button to select tape type.



- 3** Select dubbing speed (**NORMAL** or **HIGH**) with the **DUBBING SPEED** button.

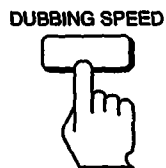

- 4** Press the **PAUSE** button, then the **▶** button on deck A.

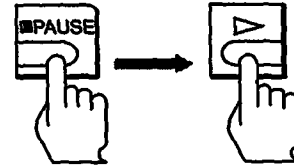

- 5** Press the **REC** button on deck B. Dubbing starts.



To stop dubbing, press the **■** **▲** button on deck A, then press the **■** **▲** button on deck B.

You need not designate the Dolby NR system

The tape in deck B is recorded with the same recording level and Dolby NR system as the original tape in deck A.

You can listen to other program sources during dubbing
Select the program source with the function selectors.

Playing Compact Discs

You can enjoy various play modes provided by the CD player.

Playing the Entire Disc — Continuous Play

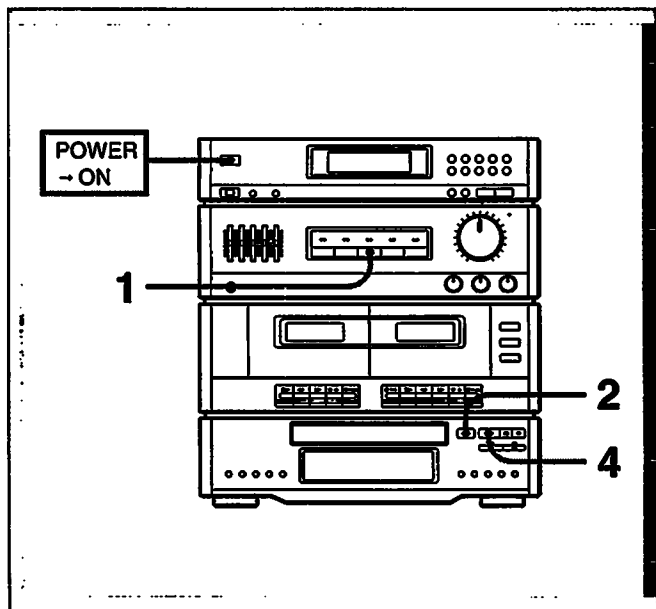

1 Press the CD button.



2 Press the OPEN/CLOSE ▲ button.



3 Place a disc with the printed side up on the tray.

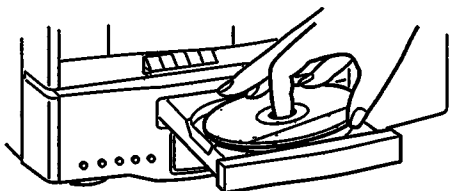

4 Press the ► button.



To stop during play, press the ■ button.

To pause, press the || button.

To resume play, press the ► or the || button again.

To stop play and open the tray, press the OPEN/CLOSE ▲ button.

To close the tray without starting play, press the OPEN/CLOSE ▲ button.

To play an 8-cm (3-inch) CD

Place it on the inner circle of the tray. If the disc is provided with an adaptor, first remove it.

Do not put a 12-cm (5-inch) CD upon an 8-cm CD.

If you press the TUNER button during play

The CD player is turned off and disc play stops.

Caution on volume adjustment

Do not turn up the volume while listening to a portion with very low level inputs or no audio signals. If you do the speakers may be damaged when a peak level portion is played.

On moisture condensation

If the unit is brought directly from a cold to a warm location, or is placed in a very damp room, moisture may condense on the lens inside the unit. Should this occur, the unit will not operate. In this case, remove the disc and leave the unit turned on for about an hour until the moisture evaporates.

Information in the Display

When you press the OPEN/CLOSE \blacktriangle button to close the tray, or press the TIME button in stop mode, the display shows you the following information:
The total number of selections (a) and the total playing time of the inserted disc (b)).

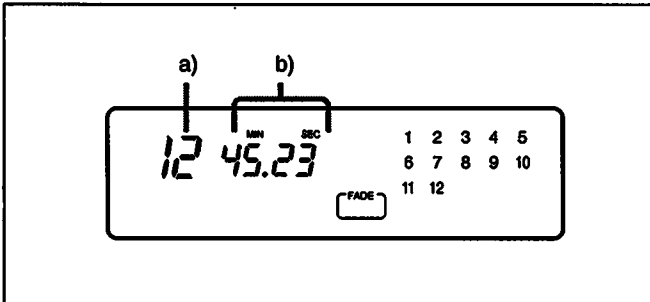

Each time you press the TIME button during play (continuous, shuffle or program), the display changes to show you the following information:

- Remaining time in the current selection (a)).
If the current selection number is over 20, "— . —" is displayed.
- Remaining time of the disc (b))
- Elapsed playing time (c))

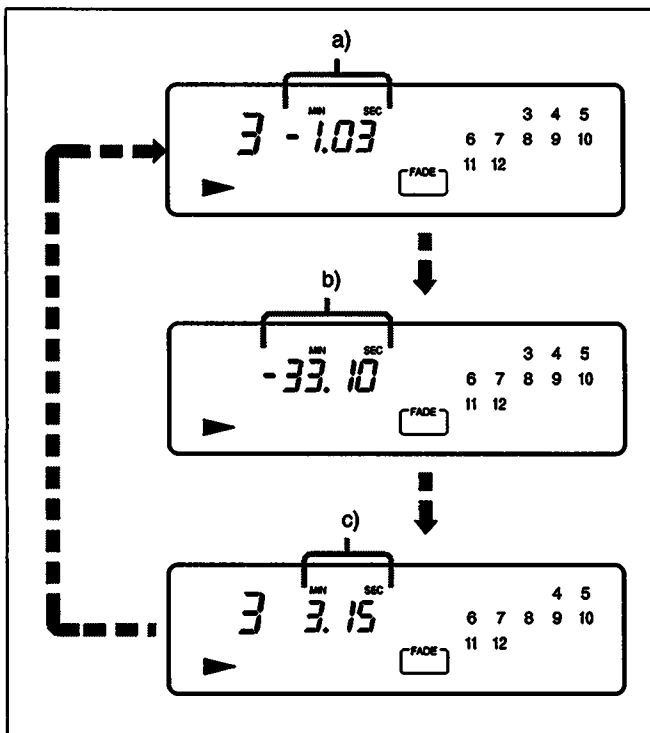

The "no disc" indication appears
When there is no disc in the tray.

If you press the TIME button during stop
The total time and total number of selections will be displayed.
If a program is stored, the total number of programmed selections will be displayed.

Playing Compact Discs

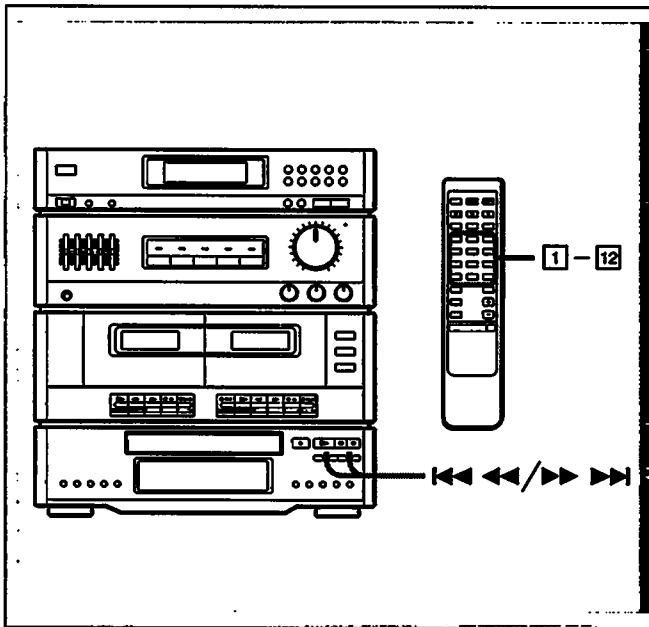

Locating a Particular Point on the Disc

To search quickly while monitoring the sound
Keep the ►► ►► or ◀◀ ◀◀ button pressed during play, then release it at the desired point.

To search quickly while observing the display
Press the || button to pause, then keep the ►► ►► or ◀◀ ◀◀ button pressed. The search speed will increase but there will be no sound. Watch the display to find the desired point. To resume play, press the ► or || button at the desired point.

The "rr" indication appears

When you reach the end of a disc by continuously pressing the ►► ►► button.

Press the ◀◀ ◀◀ (or ◀◀) button to return to normal indication.

Locating a Particular Selection

You can locate the beginning of a desired selection during stop, play or pause mode.

To locate the beginning of the current or preceding selection

- Press the ◀◀ ◀◀ (or ◀◀) button as many times as required.
- Keep the ◀◀ ◀◀ (or ◀◀) button pressed to skip selections. (This is operable during the stop mode only, when using the button on the main unit.)

To locate the beginning of a succeeding selection

- Press the ►► ►► (or ►►) button as many times as required.
- Keep the ►► ►► (or ►►) button pressed to skip selections. (This is operable during the stop mode only, when using the button on the main unit.)

To locate directly

Press one of the numeric buttons (1 to 12) on the remote commander to enter the desired selection number.

Playing in a Random Order

You can have the selections played in a random order.
The unit will play all the selections, or just the selections you desire.

Shuffle Play

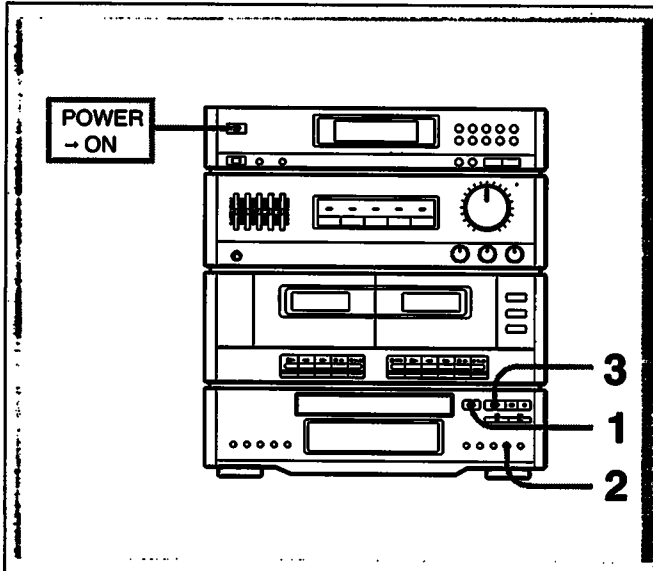

To stop playing
Press the ■ button.

To cancel shuffle play
Press the CONTINUE button and the unit enters continuous play mode. "SHUFFLE" disappears from the display.

To play only desired selections in a random order — Delete shuffle play (only performed by the remote commander)
Delete the undesired selections before or during play.

To delete a selection, press the numeric button on the remote commander for that selection (only from the selection number 1 to 12). "OFF" will be displayed in the display.
When selections have been deleted before playing, the remaining selections can be played by pressing the ► button.

To restore a selection which you have deleted, press the numeric button for that selection. "On" appears in the display.

To restore all the selections you have deleted, press the ■ button during stop mode.

When delete shuffle play ends
The unit will be ready to play the same remaining selections in a different order.

What is this indication?



This indication appears while the player is "shuffling" the selections.

1 Place a disc on the tray.

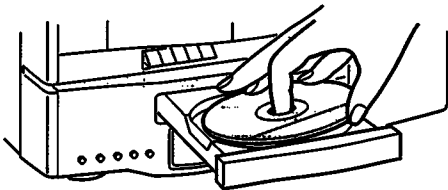

2 Press the SHUFFLE button.
"SHUFFLE" appears in the display.

SHUFFLE

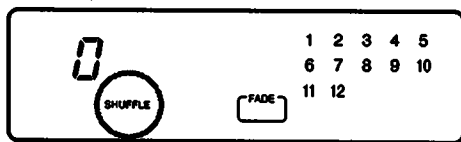

3 Press the ► button.
Shuffle play starts.



Playing in a Desired Order and Time

You can make a program by designating up to 24 selections in the order you want them to be played. At the same time, you can adjust the total playing time of the program. The unit will play the disc according to your program.

Designating the Playing Order

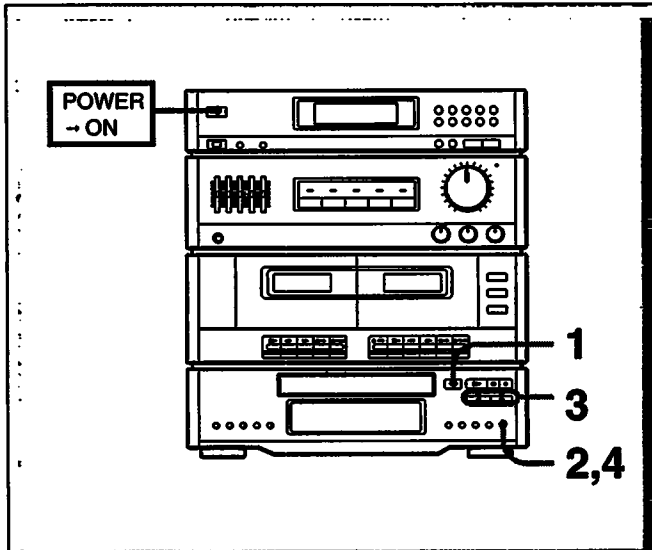

1 Place a disc on the tray.

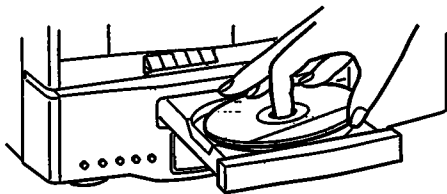

2 Press the PROGRAM button.
"PROGRAM" appears in the display.

PROGRAM



3 Press the **◀◀** or **▶▶** button to change a selection and check the time.
If satisfactory, go to the next step. If not, choose another selection.

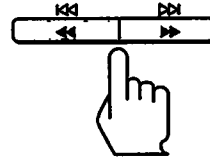

4 Press the PROGRAM button to store the selection.

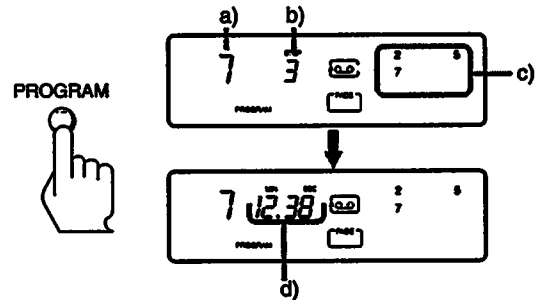

- a) Last programmed selection
- b) The order to be played
- c) Programmed selection numbers
- d) Total playing time of selections

5 Repeat steps 3 and 4.

You can play the same program repeatedly as long as you do not cancel program play or erase the program. You can also program selections (only from selection number 1 to 12) directly by pressing the numeric buttons on the remote commander.

Playing the Beginning of Each Selection

This function can be used in any play mode.

To play the program

Press the ► button.

To stop playing

Press the ■ button.

To cancel program play

Press the CONTINUE button, the unit enters continuous play mode. The program will be erased.

To erase the entire program

Press the ■ button once during stop; twice during play. The program is also erased when the unit is turned off.

If you press the PROGRAM button during play

You can make a program. The selection being played will be the first one in the program.

To check your program

Press the CHECK button. The first selection in the program will be displayed.

Each time you press the CHECK button, the next selection in the program will be displayed. After the last selection, "End" will be indicated and the display will soon return to the initial status.

To change your program

You can make the following changes before starting play.

To erase the last selection, press the CLEAR button.

Each time you press the CLEAR button, the last selection in the program will be erased.

To add a selection to the end of the program, just press the numeric button for that selection. You can also add a selection during play or pause.

To delete a selection, press the CHECK button repeatedly until the undesired selection is displayed. Then press the CLEAR button.

To change the order, press the ■ button during stop to erase the program. Then repeat the programming procedure from the beginning.

Music Scan Play

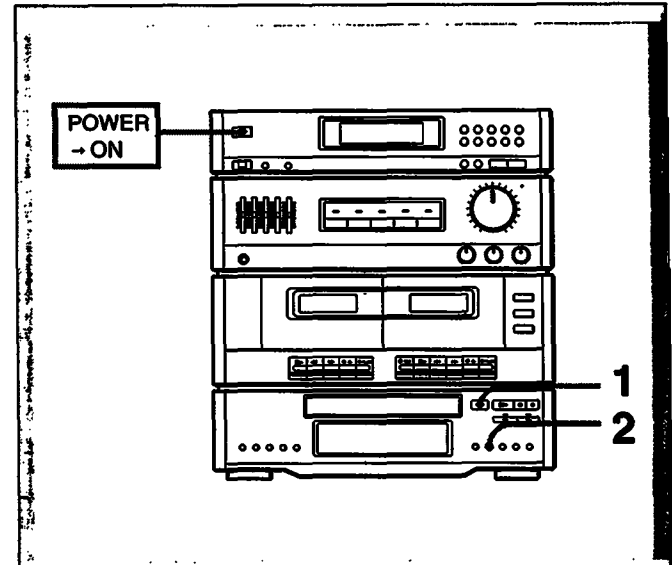

1 Place a disc on the tray.

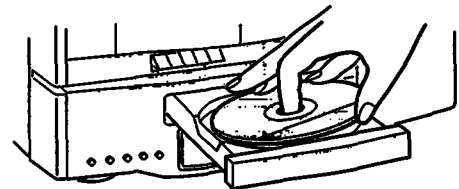

2 Press the MUSIC SCAN button.

Each selection will be played for 10 seconds and then fade out for 2 seconds. After all selections are played, scan play will end.

MUSIC SCAN

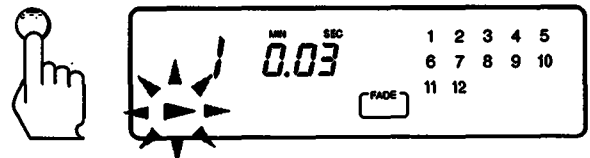

To start playing immediately

Press the ► button.

To stop music scan during scanning

Press the ■ button.

Note

When you press the MUSIC SCAN button again, while playing the beginning of a selection, playing will be extended for another 10 seconds.

Playing Repeatedly

You can choose between two different repeat play modes. One repeats selections in the current play mode, the other repeats any particular selection you like.

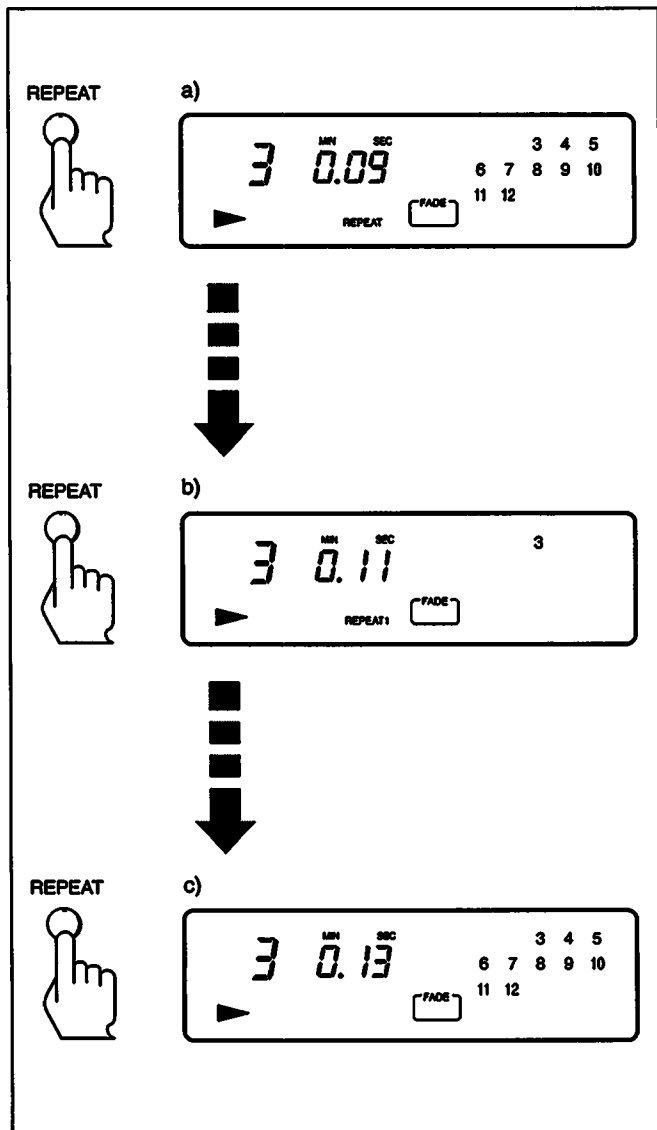

Repeating Selections

To repeat all selections a)

Press the REPEAT button once. "REPEAT" appears in the display.

The unit will repeat in the current play mode after completing the first play.

Play mode	Selections to be played
Continuous play	All the selections
Program play	All the programmed selections in the same order
Shuffle play	All the selections that the unit reshuffles
Delete shuffle play	All the remaining selections that the unit reshuffles

To repeat the selection currently playing b)

(only during continuous play)

Press the REPEAT button again. "REPEAT1" appears in the display. The unit will repeat the current selection.

To cancel repeat play c)

Press the REPEAT button again.

In continuous play mode, "REPEAT1" disappears.

In any other play mode, "REPEAT" disappears.

Recording the Program

You can insert a pause in your program by pressing the **||** button. Use this function to make a program for both sides of the tape at one time.

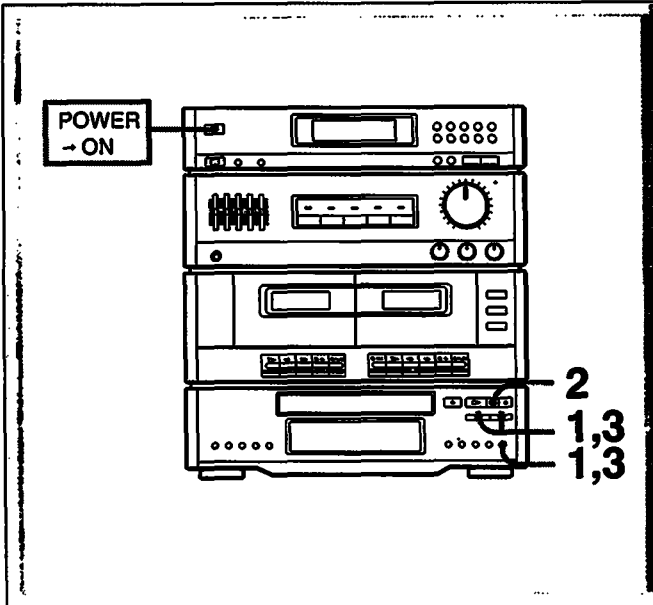

1 Choose selections for side A. (See page 18)

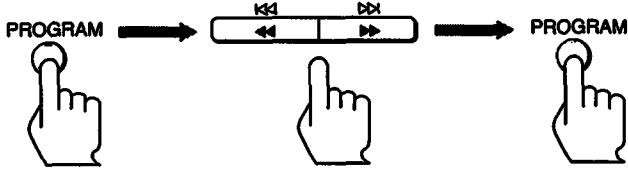

2 Press the **||** button.

"P" will appear in the display and the total playing time will be reset to 0.



3 Choose selections for side B.

(See page 18)

When you start playing, the selections for side A will be played and then the unit will pause with the chosen selections for side B illuminated in the display. Set the tape to the beginning of side B, then press the **▶** or **||** button. The selections for side B will be played.

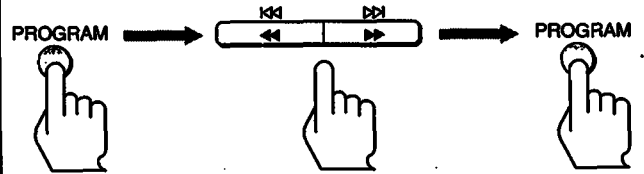

What is the tape indicator?

During program play, the tape indicator shows you which side of the tape is being played.

: Side A is being played.

: Side A has been played and the unit is in pause mode, or side B is being played.

To check the remaining time

Press the TIME button once to see the remaining time of the selection being played; twice to see the total remaining time; once more to return to the initial display.

If you have inserted a pause, the display shows the remaining time until the pause.

appears while checking the program for side A and also appears while checking the program for side B.

If " . . . " is displayed instead of the actual time

- you have programmed a selection number over 20.
- the total time has exceeded 100 minutes.

Designating the Total Playing Time

You can designate a playing time and the unit will make two different programs of selections each fitting within that period. Use this function, by designating the length of your tape, for editing both sides of a tape.

This feature, called time edit, sets the playing time of each program within the designated time automatically by choosing selections in numerical order.

You can also program desired selections by priority. In this case, you can designate desired selections beforehand and the remaining selections will be programmed to fit the remaining time.

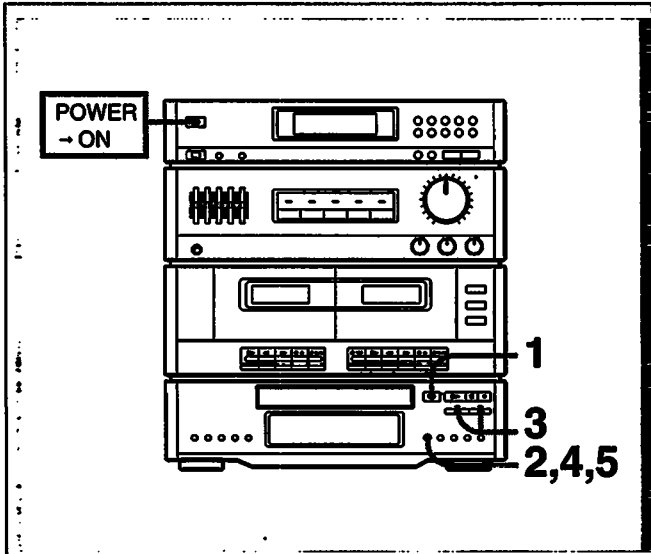

1 Place a disc on the tray.

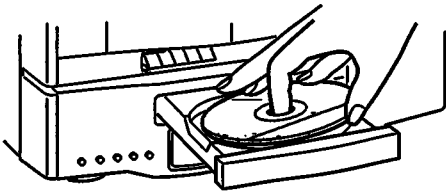

2 Press the EDIT button and display "EDIT".



3 Press the |◀◀ ◀◀ / ▶▶ ▶▶| (or |◀◀ / ▶▶|) button.

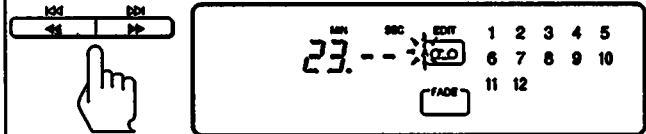

Each time you press the |◀◀ ◀◀ / ▶▶ ▶▶| (or |◀◀ ▶▶|) button, the display changes to give you the following duration.

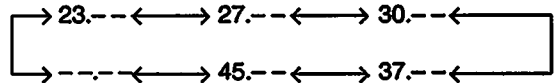

To designate the length of one side of your tape by the numeric buttons.

Press [10] for 0 on the remote commander. It is generally not necessary to press numeric buttons for seconds.

To adjust the seconds

Keeping the |◀◀ ◀◀ / ▶▶ ▶▶| button pressed changes the set time by 10 second intervals.

4 Press the EDIT button.

The selections for program A are determined automatically. Then the display shows the last selection to be recorded (a)), total playing time (b)), and the selections to be recorded (c)).

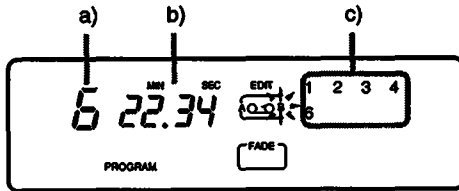

5 Press the EDIT button once more while "B" in the tape indicator is blinking.

Another program for the other side is completed.

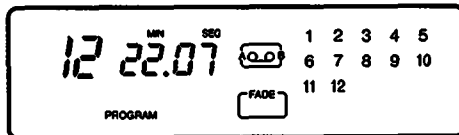

To play the program

Press the ► button.

The selections for side A will be played and then the unit will pause. Set the tape to the beginning of side B, then press the ► or the || button. The selections for side B will be played.

To stop playing

Press the ■ button.

You can play the same program repeatedly as long as you do not cancel the edit or erase the program.

To cancel the edit

Press the CONTINUE button and put the unit into continuous play mode.

The program will be erased.

To erase the entire program

Press the ■ button once during stop; twice during play. The program is also erased, when you turn off the unit.

To check the program

See page 19.

If your disc has more than 20 selections

Selection over number 20 cannot be programmed with the time edit function; use the programming procedure on page 19.

To designate a different time for each side

Execute steps 1 to 4 on page 18, then press the || button. Then execute steps 3 and 4 for the other side.

If you have included desired selections in the program

The selections of your choice will be replaced with other ones for the unit to fit the program as close to the designated period as possible.

Tips on Editing Tapes

The following functions are convenient for editing your own tapes.

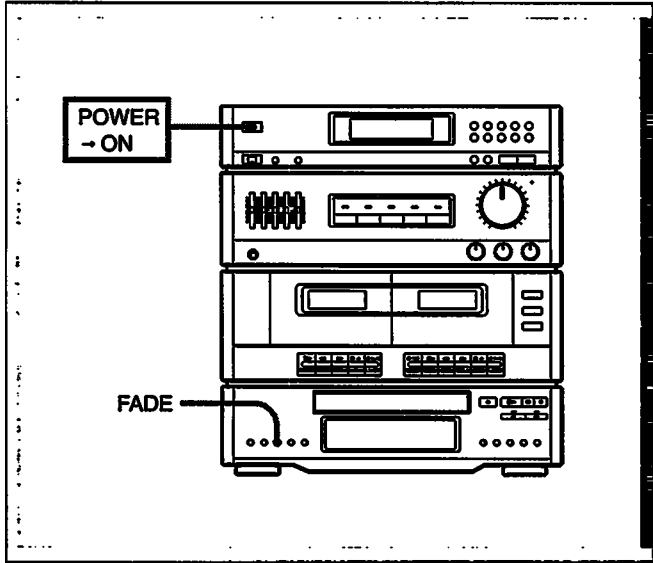

Fading In/Out

You can have the play fade in or fade out from 2 to 10 seconds.

To end the play fading out

Press the FADE button when you want to start fading out. "|||>" in FADE flashes in the window, and play fades out and the unit enters pause mode.

To restart the play fading in

Press the FADE button in the pause mode. "<|||" in FADE flashes in the window. The unit enters play mode and play fades in.

To designate the fading duration

- 1 Press the FADE button during stop mode.
- 2 Designate the fading duration within the range of 2 to 10 seconds by pressing the **⏮ ⏪ / ⏩ ⏭** (or **⏮ / ⏭**) button.
- If you do not designate the duration, it is set to 5 seconds.
- 3 Press the FADE button again.

Note

Whenever the unit is turned off, fading time is reset to 5 seconds.

Fading Out at the Desired Time — Time Fade

You can have the play fade out at the end by designating the play duration. Once the time fade is set, it functions twice for editing both sides of a tape. You can change discs without cancelling this function and use it in any play mode.

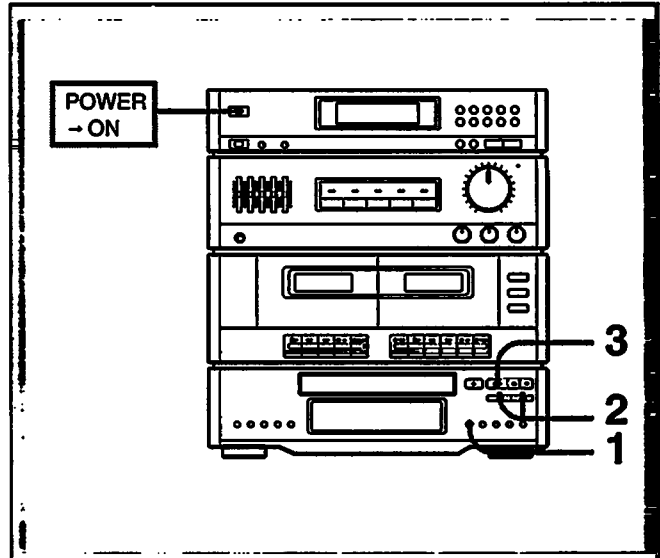

- 1** Press the EDIT button twice during stop mode, (or press it once in pause mode). "TIME FADE" and "A" in the tape indicator appears in the display.

EDIT

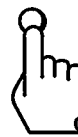

- 2** Set the desired play duration, using either the **⏮ ⏪ / ⏩ ⏭** (or **⏮ / ⏭**) button or numeric buttons on the remote commander.

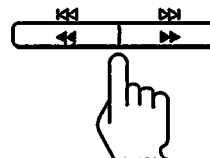

- a) The **I◀◀ ◀◀ / ▶▶ ▶▶** (or **I◀◀ / ▶▶**) button — Useful when using commercial tapes (46-, 54-, 60-, 74- and 90-minute tapes). Each time you press the **I◀◀ ◀◀ / ▶▶ ▶▶** (or **I◀◀ / ▶▶**) button, the play duration for one side of the tape is displayed as follows.

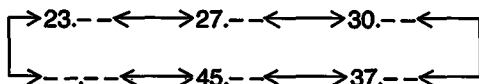

- b) Numeric buttons (1 – 10) — Useful when setting the time for one side of the tape as you want. (See page 19.) You need not press buttons for the seconds, unless required.

3 Press the ▶ button to start playing.

Before the unit enters pause mode at the set time with "B" lit in the tape indicator, play starts to fade out.



To start play for the other side of the tape

Press the ▶ or || button.

The unit enters pause mode at the set time by fading out 2 – 10 seconds.

When this play ends, time fade is cancelled.

To cancel time fade

Press the EDIT button again.

To display the time remaining until the set time

Press the TIME button twice.

Maintenance

Keep your system in good condition to obtain the best sound.

Cleaning the Cabinets

Use a soft cloth lightly moistened with a mild detergent solution.

Demagnetizing the Heads

Remove magnetism built up on the heads after every 20 to 30 hours of use.

Turn off the unit before demagnetizing the heads. Use any commercially available demagnetizer.

Cleaning Heads and Tape Path

Clean after every 10 hours of use and before recording.

- 1 Press the  button to open the cassette holder.
- 2 Moisten a cotton swab slightly with cleaning fluid or alcohol.
- 3 Wipe heads, pinch roller and capstans.

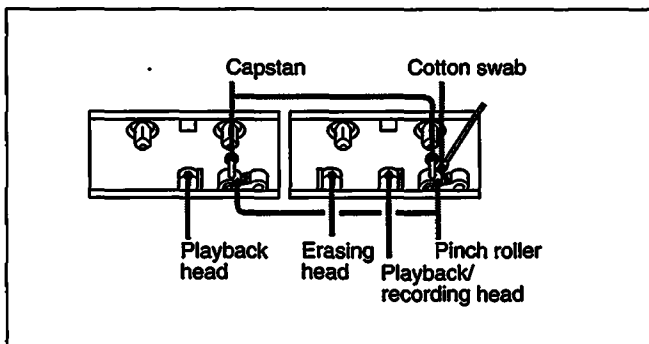

Do not insert a cassette until cleaned areas are completely dry.

Cleaning Discs

When a disc becomes dirty, clean it with a cleaning cloth. Wipe the disc from the center outward. Do not use solvents such as benzine, thinner, commercially available cleaners or anti-static spray intended for analog discs.

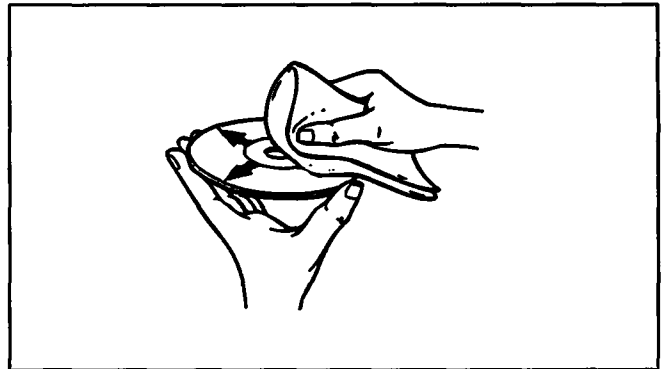

Specifications

AUDIO POWER SPECIFICATIONS POWER OUTPUT AND TOTAL HARMONIC DISTORTION:

with 6 ohm loads both channel driven, from 40 - 20,000 Hz; rated 15 watts per channel minimum RMS power, with no more than 0.5% total harmonic distortion from 250 milliwatts to rated output.

Tuner

System FM stereo
FM/AM superheterodyne tuner

FM tuner section

Tuning range 87.5 to 108 MHz
Antenna 300 ohms balanced
75 ohms unbalanced

Intermediate frequency 10.7 MHz

AM tuner section

Tuning range 530 to 1,710 kHz
Antenna AM loop antenna
External antenna terminal

Intermediate frequency 450 kHz

Amplifier

Input	Jack type	Sensitivity	Impedance
VIDEO	Phono	300 mV	47 kilohms
PHONO	Phono	3 mV	47 kilohms

Output	Jack type	Impedance
HEADPHONES	Stereo phone	Accepts headphones of 8 ohms or more

Frequency response VIDEO: 15 Hz to 50 kHz ± 3 dB

Cassette deck

Recording system 4-track 2-channel stereo
Frequency response DOLBY NR OFF
With Type II cassette (Sony UX-S)
40 Hz to 14 kHz (± 3 dB)
With Type I cassette (Sony HF-S)
40 Hz to 13 kHz (± 3 dB)
Wow and flutter 0.1% (WRMS)

Compact disc player

Frequency response 2 Hz to 20 kHz ± 0.5 dB
Signal-to-noise ratio More than 93 dB
Dynamic range More than 90 dB
Harmonic distortion Less than 0.008% (1 kHz)
Channel separation More than 90 dB (1 kHz)

General

Power requirements 120 V AC, 60 Hz
Power consumption 85 W
Weight Approx. 8.6 kg (18 lb 15 oz)
Dimensions Approx. 355 x 380 x 325 mm
(14 x 15 x 12 $\frac{7}{8}$ inches)
(w/h/d, including projections)

Speaker systems

Speaker system 3-way
Weight Approx. 4.3 kg (9 lb 7 oz), per speaker
Dimensions Approx. 260 x 441 x 175 mm
(10 $\frac{1}{4}$ x 17 $\frac{3}{8}$ x 7 inches)(w/h/d)

Accessories supplied

Remote commander RM-S171 (1)
Batteries Sony SUM-3 (NS) (2)
FM wire antenna (1)
AM loop antenna (1)

Design and specifications are subject to change without notice.

Troubleshooting Guide

Before going through the check list below, first refer back to the connections and operating procedures.

Should any problem persist after you have made these checks, consult your nearest Sony service facility.

General

Symptom	Cause	Remedy
No power	AC power cord is not connected securely	Connect the AC power cord securely
No sound	Volume is not turned up	Turn up the volume
	Wrong connection	Connect the speaker cords correctly
Reversed left and right sound	Wrong connection	Connect the speaker cords correctly
Severe hum or noise	Loose connections	Make connections securely
	Unit is near TV or VCR	Move TV or VCR away from the unit

Tuner

Symptom	Cause	Remedy
The "TUNED" or "STEREO" indication blinks	Antenna is not aimed in the right direction	Adjust the location and direction of the antenna
	Weak signal	Connect to an external antenna if the indication still blinks
Severe hum or noise	Antenna is not aimed in the right direction.	Adjust the location and direction of the antenna.
	Weak signal	Connect to an external antenna if hum or noise still interferes with reception

Cassette deck

Symptom	Cause	Remedy
You cannot play back a tape	PAUSE is engaged	Press the PAUSE button to release the unit from the pause mode
You cannot record on a tape	The tab has been removed from the cassette	Cover it with a piece of adhesive tape
You cannot dub tapes	The tab of the cassette in deck B has been removed	Cover it with a piece of adhesive tape
Unbalanced tone in higher frequencies	The DOLBY NR is not in the correct position	Set the DOLBY NR switch to the same position as was set for recording.
Unclear recording or playback	Dirty head	Clean and demagnetize the recording/playback head
Excessive wow or flutter, or sound dropout.	Dirty capstan and pinch roller	Clean the capstan and pinch roller
Incomplete erasure	Magnetized head	Demagnetize the erasing head

Remote commander

Symptom	Cause	Remedy
The remote commander does not operate the unit	The batteries are run down	Replace both batteries
	The remote commander is not pointed at the remote sensor	Point the remote commander at the sensor
	There is an obstacle between the remote commander and the unit	Remove the obstacle
	The remote commander is too far from the unit	Move closer
Operation is not possible	The internal control program may not be functioning	Turn off the power and turn it again

CD player

Symptom	Cause	Remedy
The disc tray does not close	The disc is not placed correctly	Place the disc correctly on the disc tray
Play does not start	Dirty disc	Clean the disc
	The disc is inserted upside down	Insert the disc with the printed side up
	is engaged	Press the ► or button again to release it
	Moisture condensation	Leave the unit turned on for approximately one hour
Play does not begin from the first selection	The unit is in the program or shuffle mode	Press the CONTINUE button

Location of Controls

Refer to the pages indicated in parentheses for details.

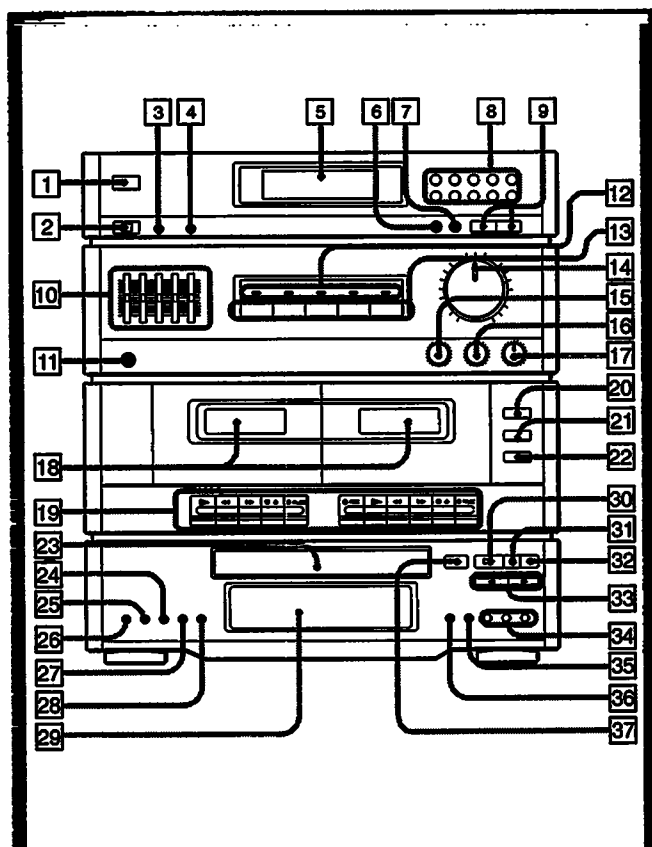

Compact Disc Deck Receiver HCD-D117

Tuner section

- 1 POWER switch (page 6)
- 2 Remote sensor
- 3 MEMORY button (page 9)
- 4 ST/MUTE button (page 8)
- 5 Display window
- 6 SHIFT button (page 9)
- 7 BAND SELECT button (page 8)
- 8 Numeric buttons (page 9)
- 9 DUAL MODE TUNING +/- buttons (pages 8,9)

Amplifier section

- 10 5 BAND GRAPHIC EQUALIZER controls (page 7)
- 11 HEADPHONES jack (page 7)
- 12 FUNCTION INDICATOR
- 13 Function selectors
- 14 VOLUME control and indicator (page 6)
- 15 SURROUND control (page 7)
- 16 DBFB (dynamic bass feedback) control (page 7)
- 17 BALANCE control (page 7)

Cassette deck section

- 18 Cassette holders
- 19 Tape operating buttons
 - ▶ (play) button, ■ ▲ (stop / eject) button, ▶▶ (rightward fast winding) button, ◀◀ (leftward fast winding) button, || PAUSE button, ● REC button (only for deck B)
- 20 TAPE SELECT button (pages 10, 11, 13)
- 21 DUBBING SPEED (HIGH / NORMAL) button (page 13)
- 22 DOLBY NR (noise reduction) switch (pages 10, 11)

Compact disc player section

- 23 Disc tray
- 24 FADE button (page 24)
- 25 REPEAT button (page 20)
- 26 TIME button (page 15)
- 27 CHECK (program check) button (page 19)
- 28 CLEAR (program clear) button (page 19)
- 29 Display window
- 30 ▶ (play) button (page 14)
- 31 || (pause) button (page 14)
- 32 ■ (stop) button (page 14)
- 33 ◀◀ ◀ / ▶▶ ▶▶ (AMS*) buttons (page 16)
- 34 PLAY MODE buttons
 - PROGRAM button (page 18)
 - SHUFFLE button (page 17)
 - CONTINUE button (pages 17, 19)
- 35 MUSIC SCAN button (page 19)
- 36 EDIT button (pages 22, 23, 24, 25)
- 37 OPEN/CLOSE ▲ button (page 14)

* AMS is the abbreviation of Automatic Music Sensor.

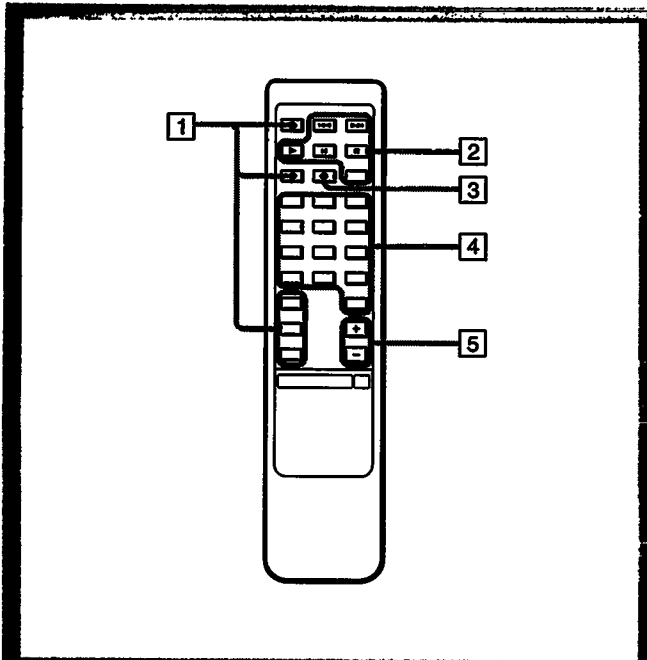

Remote Commander RM-S171

- 1 Function selectors
- 2 CD operating buttons
The DISC skip button functions only on a CD player with multiple disc trays.
- 3 SHIFT button (page 9)
- 4 Tuner operating buttons and numeric buttons for CD player
- 5 VOL (volume) +/- buttons (page 6)