

ELECTRONIC CASH REGISTER

# PCR-T2100

THANK YOU  
YOUR RECEIPT  
CALL AGAIN !

GROCERY  
DAIRY  
H. B. A.  
FROZEN  
FOOD  
DELICATESSEN

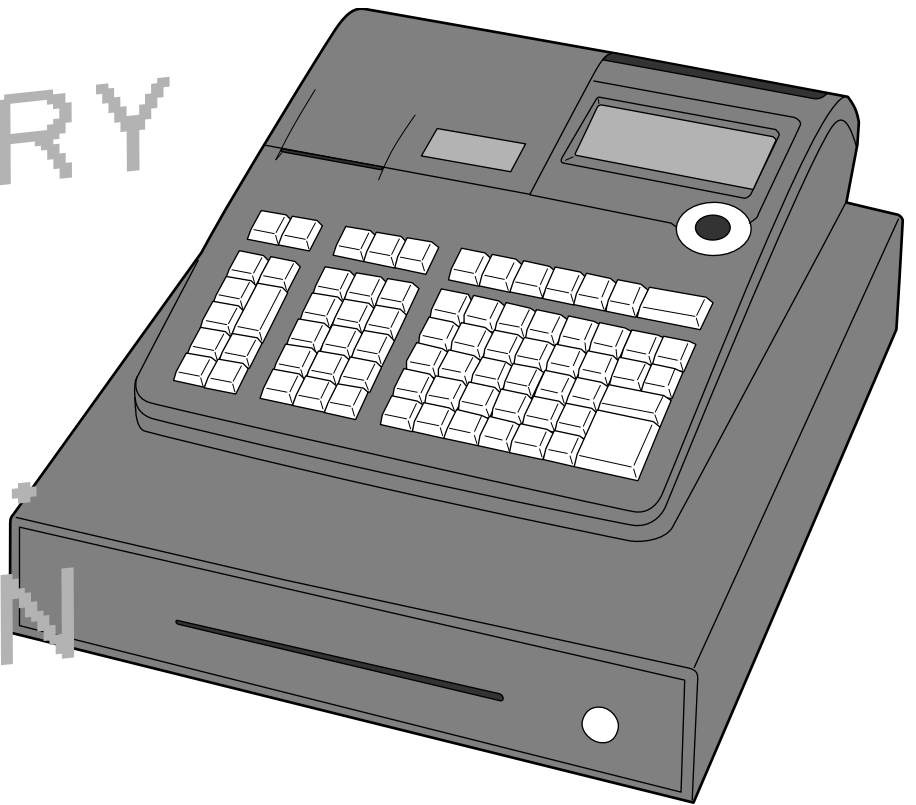

USER'S MANUAL

CI

Canada

**CASIO**<sup>®</sup>

# Introduction & Contents

## Important!

Your new cash register has been carefully tested before shipment to ensure proper operation. Safety devices eliminate worries about breakdowns resulting from operator errors or improper handling. In order to ensure years of trouble-free operation, however, the following points should be noted when handling the cash register.

*Do not locate the cash register where it will be subjected to direct sunlight, high humidity, splashing with water or other liquids, or high temperature (such as near a heater).*

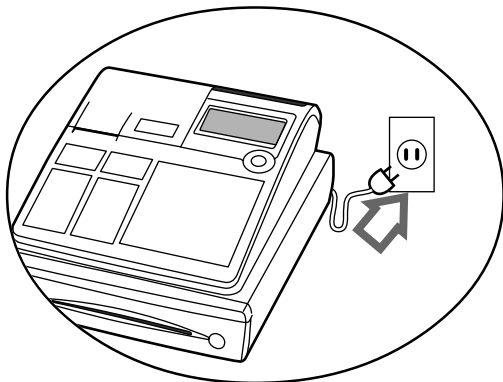
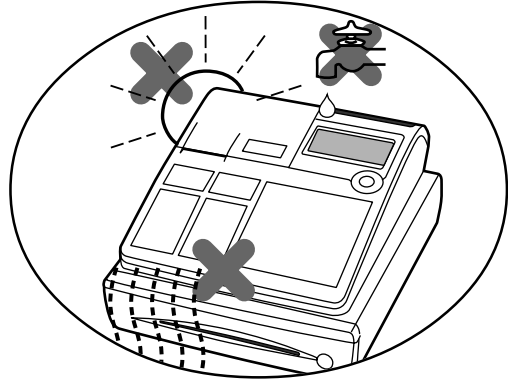

*Be sure to check the sticker on the side of the cash register to make sure that its voltage matches that of the power supply in the area.*

*Never operate the cash register while your hands are wet.*

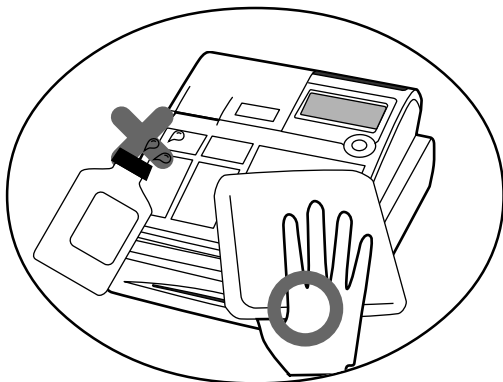
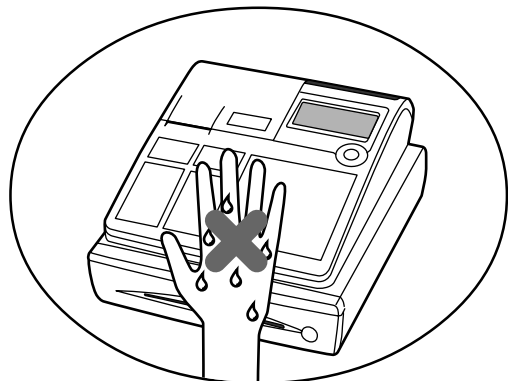

*Use a soft, dry cloth to clean the exterior of the cash register. Never use benzene, thinner, or any other volatile agent.*

*Never try to open the cash register or attempt your own repairs. Take the cash register to your authorized CASIO dealer for repairs.*

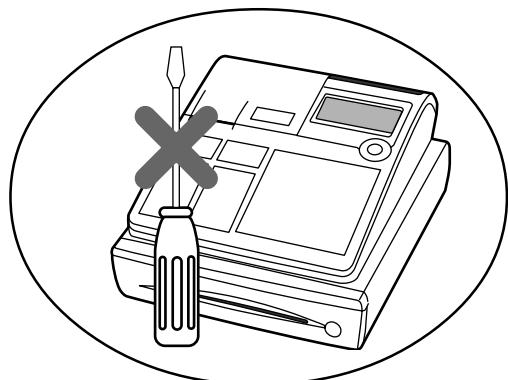

## Welcome to CASIO Cash Register!

Congratulations upon your selection of a CASIO Electronic Cash Register, which is designed to provide years of reliable operation.

Operation of a CASIO cash register is simple enough to be mastered without special training.

Everything you need to know is included in this manual, so keep it on hand for reference.

Consult your CASIO dealer if you have any questions about points not specifically covered in this manual.

### GUIDELINES LAID DOWN BY FCC RULES FOR USE OF THE UNIT IN THE U.S.A. (Not applicable to other areas)

**WARNING:** This equipment has been tested and found to comply with the limits for a Class A digital device, pursuant to Part 15 of the FCC Rules. These limits are designed to provide reasonable protection against harmful interference when the equipment is operated in a commercial environment. This equipment generates, uses, and can radiate radio frequency energy and, if not installed and used in accordance with the instruction manual, may cause harmful interference to radio communications. Operation of this equipment in a residential area is likely to cause harmful interference in which case the user will be required to correct the interference at his own expense.

**FCC WARNING:** Changes or modifications not expressly approved by the party responsible for compliance could void the user's authority to operate the equipment.

*Please keep all information for future reference.*

The main plug on this equipment must be used to disconnect mains power.  
Please ensure that the socket outlet is installed near the equipment and shall be easily accessible.

# Introduction & Contents

---

## Safety Precautions

- To use this product safely and correctly, read this manual thoroughly and operate as instructed.  
After reading this guide, keep it close at hand for easy reference.  
Please keep all informations for future reference.
- Always observe the warnings and cautions indicated on the product.

## About the icons

In this guide various icons are used to highlight safe operation of this product and to prevent injury to the operator and other personnel and also to prevent damage to property and this product. The icons and definitions are given below.



Indicates that there is a risk of severe injury or death if used incorrectly.



Indicates that injury or damage may result if used incorrectly.

## Icon examples

To bring attention to risks and possible damage, the following types of icons are used.



The  $\triangle$  symbol indicates that it includes some symbol for attracting attention (including warning). In this triangle the actual type of precautions to be taken (electric shock, in this case) is indicated.



The  $\otimes$  symbol indicates a prohibited action. In this symbol the actual type of prohibited actions (disassembly, in this case) will be indicated.



The  $\bullet$  symbol indicates a restriction. In this symbol the type of actual restriction (removal of the power plug from an outlet, in this case) is indicated.

---

## Warning!

---

## Handling the register



**Should the register malfunction, start to emit smoke or a strange odor, or otherwise behave abnormally, immediately shut down the power and unplug the AC plug from the power outlet. Continued use creates the danger of fire and electric shock.**

- Contact CASIO service representative.



**Do not place containers of liquids near the register and do not allow any foreign matter to get into it. Should water or other foreign matter get into the register, immediately shut down the power and unplug the AC plug from the power outlet. Continued use creates the danger of shorting, fire and electric shock.**

- Contact CASIO service representative.



**Should you drop the register and damage it, immediately shut down the power and unplug the AC plug from the power outlet. Continued use creates the danger of shorting, fire and electric shock.**

- Attempting to repair the register yourself is extremely dangerous. Contact CASIO service representative.



**Never try to take the register apart or modify it in any way. High-voltage components inside the register create the danger of fire and electric shock.**

- Contact CASIO service representative for all repair and maintenance.
-

---

**⚠ Warning!**

---

**Power plug and AC outlet**



Use only a proper AC electric outlet (100V~240V) . Use of an outlet with a different voltage from the rating creates the danger of malfunction, fire, and electric shock. Overloading an electric outlet creates the danger of overheating and fire.



Make sure the power plug is inserted as far as it will go. Loose plugs create the danger of electric shock, overheating, and fire.

- Do not use the register if the plug is damaged. Never connect to a power outlet that is loose.



Use a dry cloth to periodically wipe off any dust built up on the prongs of the plug. Humidity can cause poor insulation and create the danger of electric shock and fire if dust stays on the prongs.

Never use detergent to clean the power cord, especially the plug and jack.



Do not allow the power cord or plug to become damaged, and never try to modify them in any way. Continued use of a damaged power cord can cause deterioration of the insulation, exposure of internal wiring, and shorting, which creates the danger of electric shock and fire.

- Contact CASIO service representative whenever the power cord or plug requires repair or maintenance.

---

**⚠ Caution!**

---



Do not place the register on an unstable or uneven surface. Doing so can cause the register — especially when the drawer is open — to fall, creating the danger of malfunction, fire, and electric shock.



Do not place the register in the following areas.

- Areas where the register will be subject to large amounts of humidity or dust, or directly exposed to hot or cold air.
- Areas exposed to direct sunlight, in a close motor vehicle, or any other area subject to very high temperatures.

The above conditions can cause malfunction, which creates the danger of fire.



Do not overlay bend the power cord, do not allow it to be caught between desks or other furniture, and never place heavy objects on top of the power cord. Doing so can cause shorting or breaking of the power cord, creating the danger of fire and electric shock.



Be sure to grasp the plug when unplugging the power cord from the wall outlet. Pulling on the cord can damage it, break the wiring, or cause short, creating the danger of fire and electric shock.



Never touch the plug while your hands are wet. Doing so creates the danger of electric shock. Pulling on the cord can damage it, break the wiring, or cause short, creating the danger of fire and electric shock.

Never touch the printer head, platen and cutter.

---

# Introduction & Contents

---

<b>Introduction &amp; Contents .....</b>	<b>2</b>
<b>Getting Started .....</b>	<b>10</b>
1. Load the memory protection batteries and Paper rolls .....	10
2. Install receipt / journal paper. ....	11
3. Plug the cash register into a wall outlet. ....	13
4. Insert the mode key marked "PGM" into the mode switch. ....	13
5. Turn the mode switch to the "PGM" position. ....	13
6. Set the date. ....	13
7. Set the time. ....	13
8. Tax table programming .....	14
9. Select watermark on receipt. ....	16
10. Department unit price programming .....	17
11. PLU unit price programming .....	17
12. Discount rate programming .....	17
13. Issuing daily reset report .....	17
14. Advanced operations and Setups .....	18
15. Issuing reports .....	18
16. Troubleshooting .....	18
<b>Introducing the Register .....</b>	<b>20</b>
General guide .....	20
Roll paper .....	20
Mode key .....	20
Drawer .....	20
Drawer lock / Drawer key .....	20
Magnetic plate .....	20
Mode switch .....	21
How to set the Pop-up display .....	21
Display .....	22
Display panel .....	22
Main display .....	22
Customer display .....	22
Keyboard .....	24
<b>Basic Operations and Setups .....</b>	<b>26</b>
How to read the printouts .....	26
How to use your cash register .....	27
Before business hours .....	28
Checking the time and date .....	28
To display and clear the date/time .....	28
Preparing coins for change .....	28
Preparing and using department keys .....	29
Registering department keys .....	29
Programming department keys .....	31
To program a unit price for each department .....	31
To program the tax calculation status for each department .....	31
To program high amount limit for each department .....	31
Registering department keys by programming data .....	32
Preset price .....	32
Preset tax status .....	32
Locking out high amount limitation .....	32
Preparing and using PLUs .....	33
Programming PLUs .....	33
To program a unit price for each PLU .....	33
To program tax calculation status for each PLU .....	33
Registering PLUs .....	34

Preparing and using discounts .....	36
Programming discounts .....	36
Registering discounts .....	36
Discount for items and subtotals .....	36
Preparing and using reductions .....	37
Programming for reductions .....	37
To program preset reduction amount .....	37
Registering reductions .....	37
Reduction for items and subtotal .....	37
Registering credit and check payments .....	38
Check .....	38
Charge .....	38
Credit .....	38
Mixed tender (cash and check) .....	38
Shifting the taxable status of an item .....	39
Calculation merchandise subtotal .....	39
Registering returned goods in the REG mode .....	40
Registering returned goods in the RF mode .....	40
Registering money received on account .....	41
Registering money paid out .....	41
No sale registration .....	41
Making corrections in a registration .....	42
To correct an item you input but not yet registered .....	42
To correct an item you input and registered .....	43
To cancel all items in a transaction .....	44
Printing the daily sales reset report .....	45
<b>Advanced Operations .....</b>	<b>46</b>
Using clerk functions .....	46
Enable clerk feature .....	46
Assigning a clerk .....	46
Clerk number key .....	46
Single item cash sales .....	47
Currency exchange function .....	48
Registering foreign currency .....	48
Full amount tender in foreign currency .....	48
Partial tender in a foreign currency .....	49
Premium .....	50
Programming department / PLU descriptors and preset messages in the list .....	52
How to choose and set the department / PLU descriptors in the list .....	52
How to choose and set the preset receipt message and graphic logo in the list .....	52
Preset message and graphic print sample .....	52
Character manual input .....	53
Entering characters .....	53
Using character keyboard .....	53
Entering characters by multi tapping .....	54
Programming descriptors and messages by entering characters .....	55
Programming PLU descriptor .....	55
Programming department / function key descriptor .....	56
Function key .....	56
Department key .....	56
Programming message .....	57
Receipt message .....	57
Programming Clerk name .....	57
Clerk name .....	57

# Introduction & Contents

---

Programming other descriptors .....	58
Report descriptor .....	58
Grand total, special character .....	59
Report title .....	59
Machine feature program .....	60
General control program .....	60
Programming procedure .....	60
Program data (by address code) .....	60
Address code 02 (machine number) .....	60
Address code 03 (consecutive number) .....	60
Address code 04 (tax system) .....	60
Address code 05 (print control for receipt) .....	61
Address code 06 (calculation & operation control) .....	61
Address code 08 (print control for fixed total report) .....	62
Address code 10 (print control for taxable amount) .....	62
Address code 14 (currency exchange control) .....	63
Address code 15 (print control for reports) .....	63
Address code 16 (print control for grand total) .....	64
Address code 17 (print control) .....	64
Address code 19 (receipt control) .....	64
Address code 21 (message control) .....	64
Address code 27 (clerk control) .....	65
Address code 30 (thermal printer control) .....	65
Address code 34 (backlight control) .....	65
Key function program .....	66
Department key/PLU program (Batch feature programming) .....	66
Programming procedure .....	66
Program data .....	66
Department key/PLU program (Individual feature programming) .....	67
Programming procedure .....	67
Program data (by address code) .....	68
Transaction key program .....	69
Programming procedure .....	69
Program data .....	69
Clerk program .....	72
Clerk number, check number programming .....	72
Clerk other programming .....	73
Printing read/reset reports .....	74
To print the individual department, PLU read report .....	74
To print daily read reports .....	75
To print daily reset reports .....	76
Read / reset report sample .....	77
To print the periodic 1/2 sales read/reset reports .....	80
Reading the cash register's program .....	82
To print unit price/rate program (except PLU) .....	82
To print key descriptor, name, message program (except PLU) .....	82
To print the machine program (except PLU) .....	83
To print the PLU unit price .....	84
To print the PLU descriptor .....	84
To print the PLU program .....	84



---

<b>Troubleshooting .....</b>	<b>86</b>
When an error occurs .....	86
When the register does not operate at all .....	88
Clearing a machine lock up .....	88
In case of power failure .....	89
When the L sign appears on the display .....	89
<b>User Maintenance and Options .....</b>	<b>90</b>
To replace journal paper .....	90
To replace receipt paper .....	91
Options .....	91
<b>Specifications .....</b>	<b>92</b>
<b>Index .....</b>	<b>93</b>

# Getting Started

This chapter shows how to setup the cash register and get it ready to operate. Please read this chapter even if you have used a cash register before.

## 1. Load the memory protection batteries and Paper rolls

### Load the two memory protection batteries

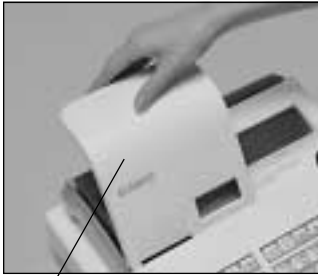

printer cover

1. Remove the printer cover and open the platen arm (receipt side).



platen arm

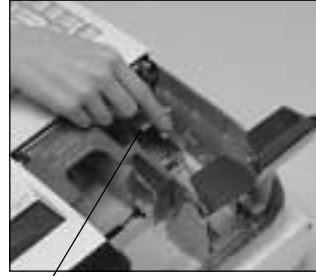

battery compartment cover

2. Remove the battery compartment cover.



3. Note the (+) and (-) markings in the battery compartment. Load a set of two new alkaline batteries so that their positive (+) and negative (-) ends are facing as indicated by the markings.



No battery is included in the accessories.

4. Replace the battery compartment cover.

5. Close the platen arm and replace the printer cover.

#### Important!

These batteries protect information stored in your cash register's memory when there is a power failure or when you unplug the cash register. Be sure to install these batteries.

#### WARNING!

- Never try to recharge the batteries supplied with the unit.
- Do not expose batteries to direct heat, let them become shorted or try to take them apart.

Keep batteries out of the reach of small children. If your child should swallow a battery, consult a physician immediately.

## 2. Install receipt / journal paper.

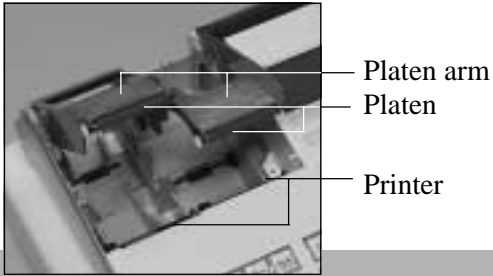

**Important!**

Take away the head protection sheet from the printer and close the platen arm.

**Caution! (in handling the thermal paper)**

- Never touch the printer head and the platen.
- Unpack the thermal paper just before your use.
- Avoid heat/direct sunlight.
- Avoid dusty and humid places for storage.
- Do not scratch the paper.
- Do not keep the printed paper under the following circumstances:  
High humidity and temperature/direct sunlight/contact with glue, thinner or a rubber eraser.

### To install receipt paper



*Step 1*  
Remove the printer cover.



*Step 4*  
Put the leading end of the paper over the printer.



*Step 2*  
Open the platen arm.



*Step 5*  
Close the platen arm slowly until it locks steadily.



*Step 3*  
Ensuring the paper is being fed from the bottom of the roll, lower the roll into the space behind the printer.



*Complete*  
Replace the printer cover, passing the leading end of the paper through the cutter slot. Tear off the excess paper.

## To install journal paper



### Step 1

Remove the printer cover.



### Step 2

Open the platen arm.



### Step 7

Slide the leading end of the paper into the groove on the spindle of the take-up reel and wind it onto the reel two or three turns.



### Step 3

Ensuring the paper is being fed from the bottom of the roll, lower the roll into the space behind the printer.



### Step 8

Replace the paper guide of the take-up reel.



### Step 4

Put the leading end of the paper over the printer.



### Step 9

Place the take-up reel into place behind the printer, above the roll paper.



### Step 5

Close the platen arm slowly until it locks steadily.



### Step 10

Press the  key to take up any slack in the paper.

During machine installation, press the  key after power on.



### Step 6

Remove the paper guide of the take-up reel.



### Complete

Replace the printer cover.

### 3. Plug the cash register into a wall outlet.

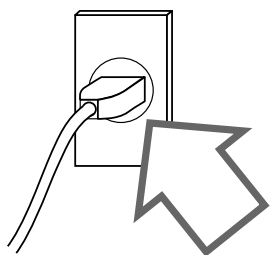

Be sure to check the sticker (rating plate) on the side of the cash register to make sure that its voltage matches that of the power supply in your area.

### 4. Insert the mode key marked “PGM” into the mode switch.

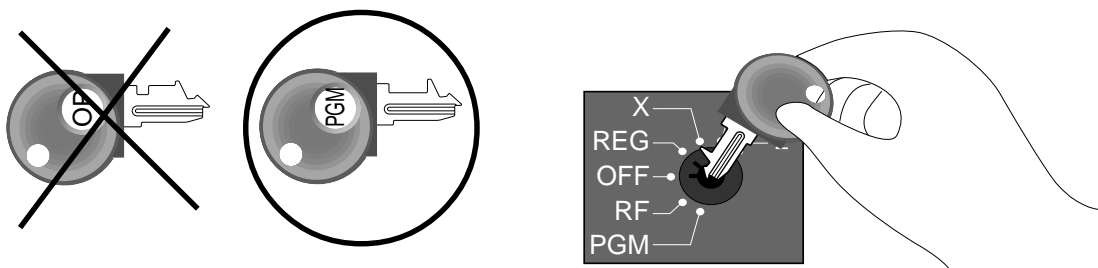

### 5. Turn the mode switch to the “PGM” position.

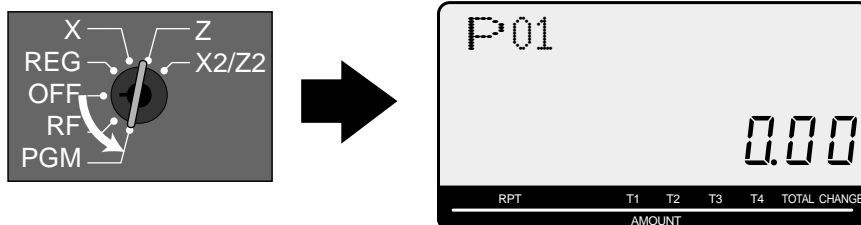

When the display shows “Low battery”, load memory protection batteries (refer to page 10).

### 6. Set the date.

1. Enter current date in year - month - day order, and press the <X/FOR>

Example: June 15, 2008 ⇒ **0 8 0 6 1 5**

2. Press <C> key.

Example: **C**

### 7. Set the time.

1. Enter current time in 24 hour system, and press the <X/FOR>

Example: 08:30 AM ⇒ **0 8 3 0** (9:45 PM ⇒ **2 1 4 5** )

2. Press <C> key.

Example: **C**

## 8. Tax table programming

### Programming automatic tax calculation

#### Important!

After you program the tax calculations, you also have to individually specify which departments (page 32) and PLUs (page 33) are to be taxed.

For this cash register to be able to automatically register state sales tax, you must program its tax tables with tax calculation data from the tax table for your state. There are three tax tables (U. S.) and four tax tables (Canada) that you can program for automatic calculation of three/four separate sales taxes.

#### Programming for the U.S. tax tables procedure

There are two ways to set up the U.S. tax tables:

A) Input the desired tax rate / Changing the tax rate

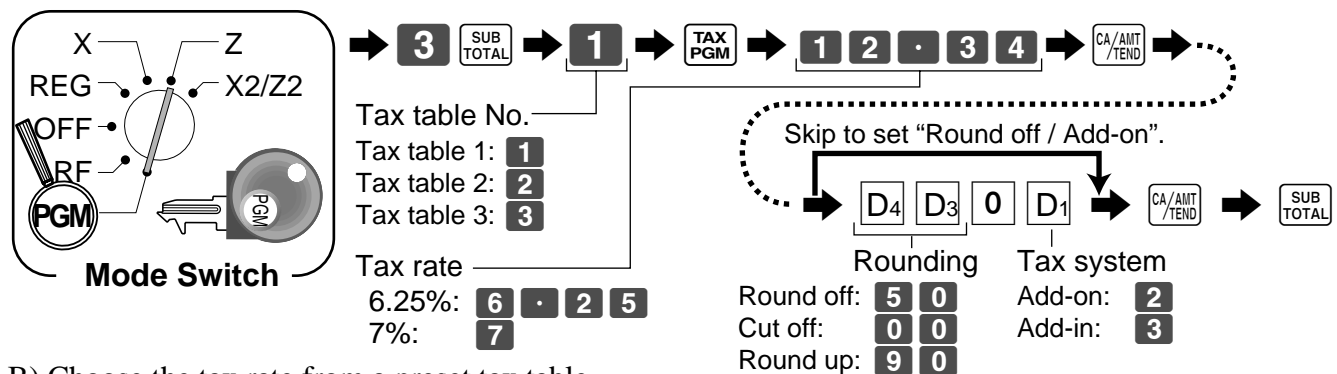

B) Choose the tax rate from a preset tax table.

The procedure to setup the tax table is printed on the guidance receipt. First issue the guidance receipt by the **HELP** key and follow it to set the tax table.



```

ENTER NUMBER THEN
PRESS <HELP> KEY.

01:HOW TO PROGRAM
DATE AND TIME?

02:HOW TO PROGRAM
TAX TABLE? (US)

:
:
    
```

```

02:HOW TO PROGRAM
TAX TABLE?

-SELECT YOUR STATE AND
ENTER NUMBER THEN
PRESS <HELP> KEY.

0101:ALABAMA
0201:ALASKA
0301:ARIZONA
0401:ARKANSAS
0501:CALIFORNIA
:
:
5001:WISCONSIN
5101:WYOMING
    
```

```

PLEASE SELECT YOUR
DISTRICT NUMBER FOR TAX
TABLE 1 (XXXX) AND TABLE
2 (YYYY) FROM BELOW
TABLE.

1)TURN MODE KEY TO PGM.
2)3<SUBTOTAL>
3)0025<SUBTOTAL>
4)XXXX <CASH> KEY.
5)YYYY <CASH> KEY.
(IF YOU DO NOT NEED
TABLE 2, JUST SKIP
STEP 5)
6)<SUBTOTAL>
XXXX, YYYY IS DISTRICT
NUMBER

ALABAMA
0101: 4% State
0102: 4.5% State & Local
:
0111: 9 % State & Local
    
```

Follow these steps.

## 8. Tax table programming (continued)

### Programming Canadian tax table

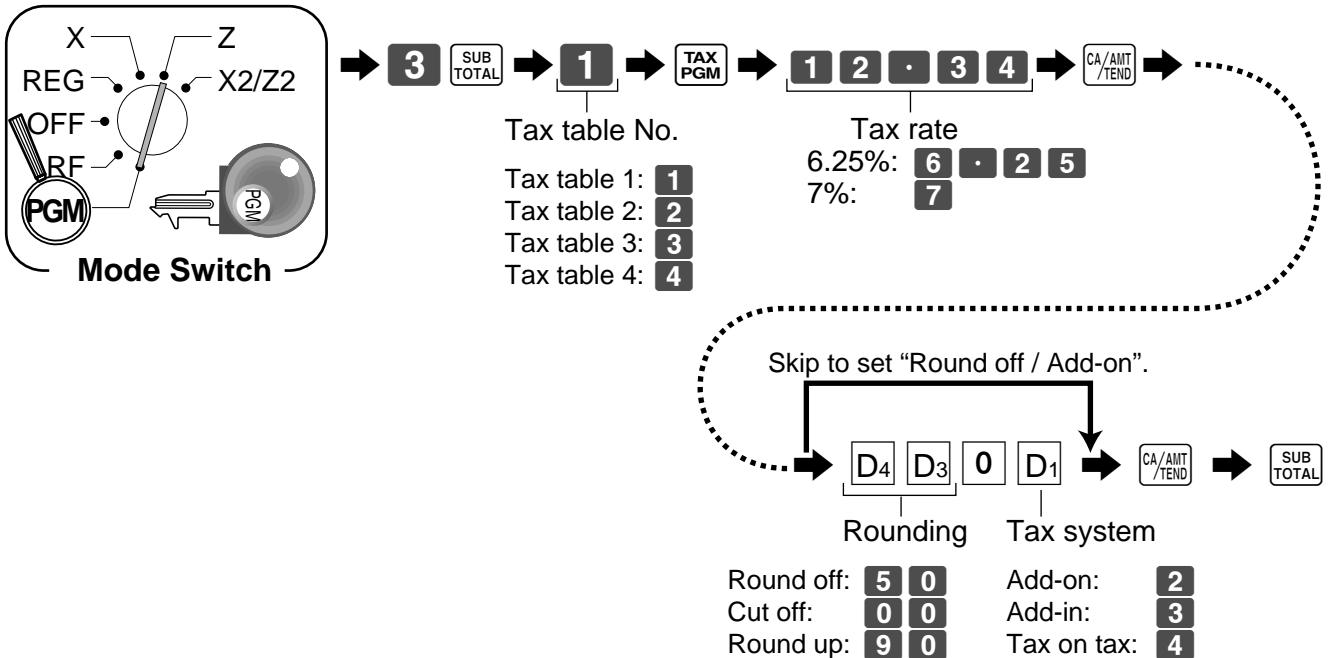

- 4 tax tables are used for the following purpose

Table 1: Used for the federal taxable items.

Table 2: Used for the provincial taxable items.

Table 3/4: Used for the provincial taxable items for different tax table.

### Important!

Be sure you use the federal sales tax data with your provincial sales tax data. Even if your province use the same tax rate as another province, inputting the wrong data will result incorrect tax calculations.

## 9. Select watermark on receipt.

Turn the mode switch to “PGM”, enter <0> or <1>, and press the <CH>, <ST>

Example: no watermark	⇒	<b>0</b>	CH	SUB TOTAL
with watermark	⇒	<b>1</b>	CH	SUB TOTAL

### NOTE:

After completion of register programming, enter **6 2 0 0** and **SUB TOTAL** in the PGM 7 mode (PGM mode ⇒ **7** **SUB TOTAL**) to backup the program data into the internal non-volatile memory.

(This operation takes about 30 seconds.)



## 10. Department unit price programming

Maximum 6-digit unit price can be set to the department.

Refer to page-32.

Tax calculation status can be set to the department.

Refer to page-32.

## 11. PLU unit price programming

Maximum 6-digit unit price can be set to the PLU.

Refer to page-33.

Tax calculation status can be set to the PLU.

Refer to page-33.

## 12. Discount rate programming

0.01 - 99.99% rate can be set to the Discount key.

Refer to page-36.

Tax calculation status can be set to the Discount key.

Refer to page-36.

## 13. Issuing daily reset report

After business hours, issue daily reset report.

Refer to page-45.

## 14. Advanced operations and Setups

Using clerk functions .....	46
Single item cash sales .....	47
Currency exchange function .....	48
Premium .....	50
Department / PLU name selection / set .....	52
Preset message /graphic selection / set .....	52
Character manual input .....	53
Machine feature program .....	60
Key function program .....	66

## 15. Issuing reports

Individual item read report .....	74
Daily read report .....	75
PLU report .....	75
Monthly report .....	75
Hourly report .....	75
Group report .....	75
Flash report .....	75
Daily reset report .....	76
Periodic sales report .....	80
Program read report .....	82

## 16. Troubleshooting

E sign appears .....	86
Drawer does not open .....	87
L sign appears .....	89
To replace receipt / journal paper .....	90, 91



# Introducing the Register

## General guide

This part of the manual introduces you to the cash register and provides a general explanation of its various parts.

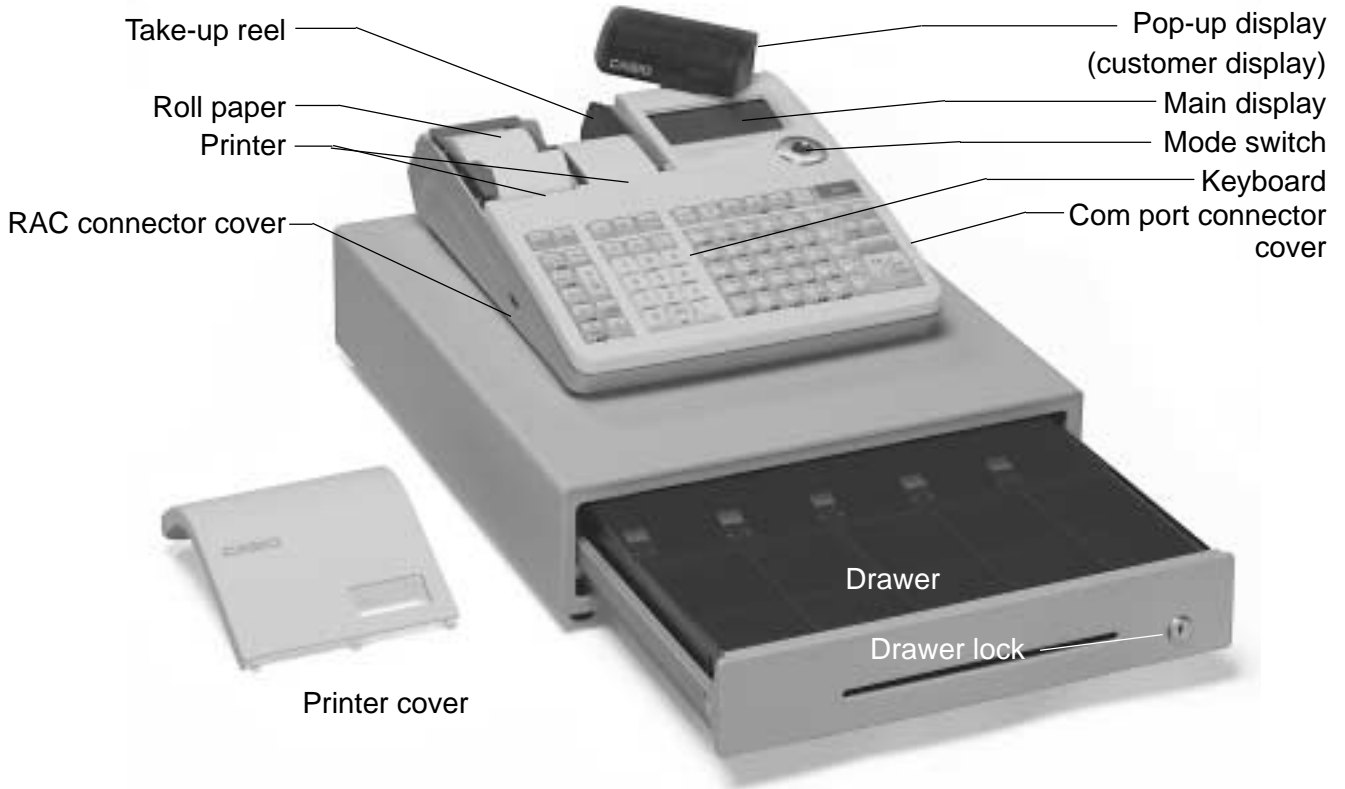

### Roll paper

You can use the roll paper to print receipts and a journal (page 11 ~ 12).

### Mode key

There are two types of mode keys: the program key (marked "PGM") and the operator key (marked "OP"). The program key can be used to set the mode switch to any position, while the operator key can select the **REG** and **OFF** position.

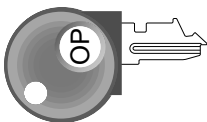

Operator key

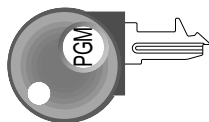

Program key

### Drawer

The drawer opens automatically whenever you finalize a registration and whenever you issue a read or reset report. The drawer will not open if it is locked with the drawer key.

### Drawer lock / Drawer key

Use the drawer key to lock and unlock the drawer.

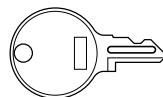

Drawer key

### Magnetic plate

Use this plate for tacking the notes received from customer.

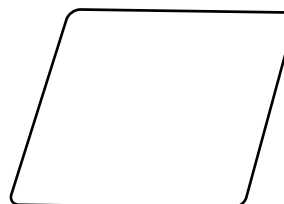

## Mode switch

Use the mode keys to change the position of the mode switch and select the mode you want to use.

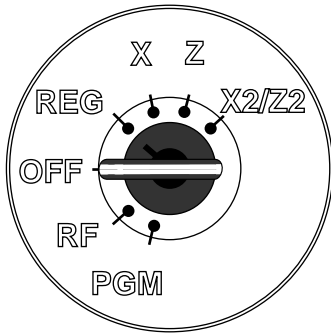

Mode Switch	Mode Name	Description
X2/Z2	Periodic sale read/reset	Used to obtain periodic sales reports without resetting total data or while resetting all total data.
Z	Daily sales reset	Used to obtain daily reports while resetting (clearing) all total data.
X	Daily sales read	Used to obtain daily reports without resetting (clearing) all total data.
REG	Register	Used for normal registration.
OFF	Stand-by	Cash register standing by.
RF	Refund	Used for registering refund transaction.
PGM	Program	Used for cash register programming.

## How to set the Pop-up display

1. Lift the unit until it stops.

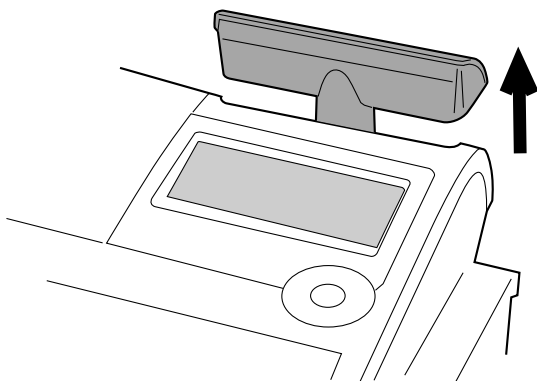

2. Rotate the unit.

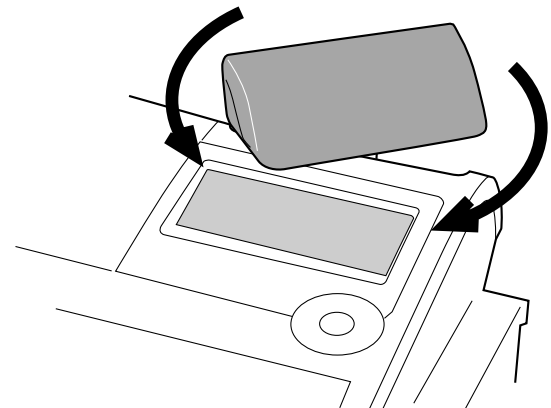

# Introducing the Register

---

## Display

### Display panel

#### Main display

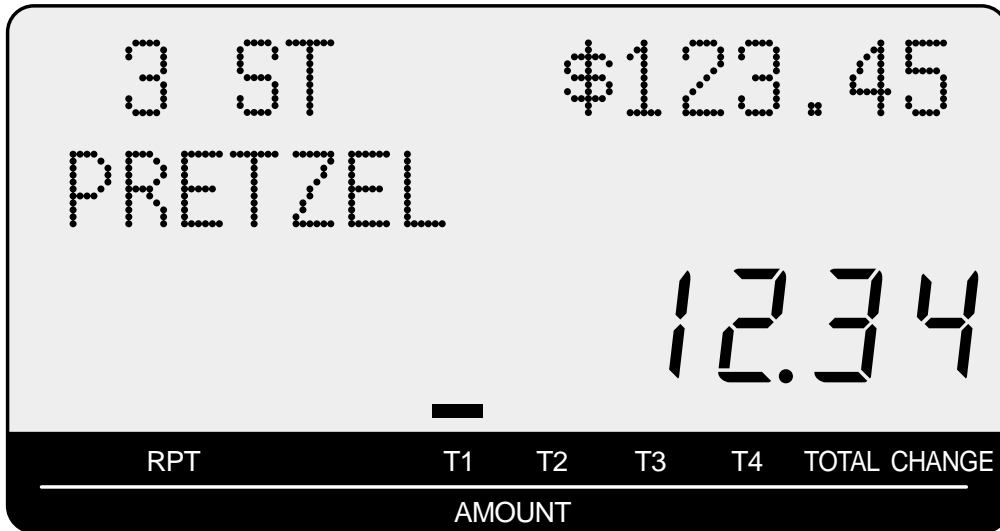

#### Customer display

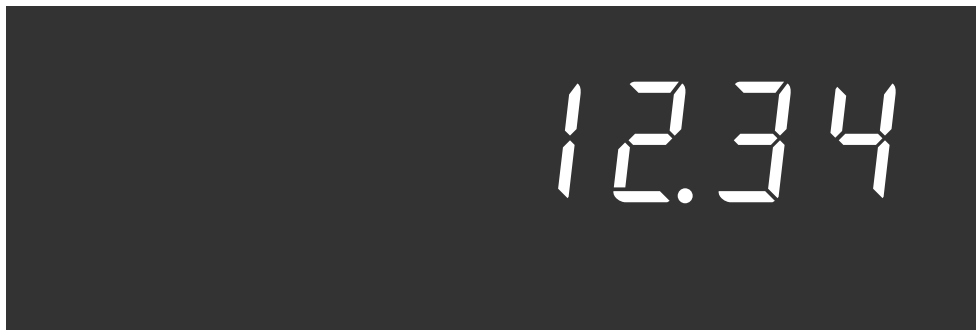

## Displays

### Main Display

(alphanumeric + numeric display)

### Pop-up (customer) display

(numeric display)

#### Item registration (by department/PLU)

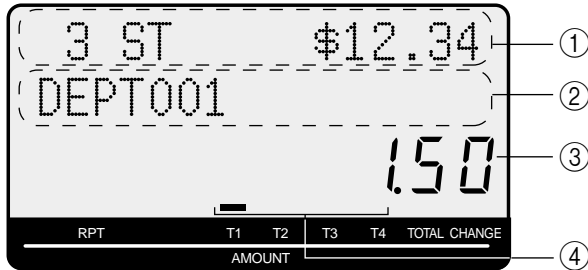

#### Repeat registration

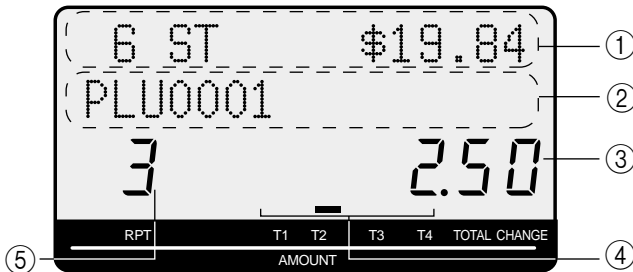

#### Totalize operation

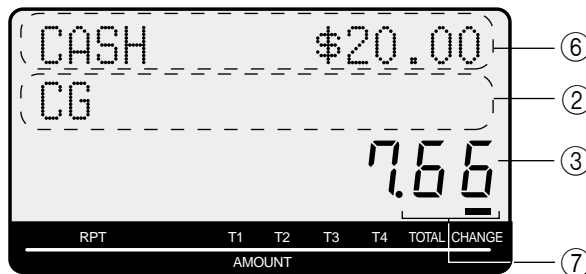

#### ① Item count and subtotal

This part of the display shows item sold count and subtotal.

#### ② Item / Key / Change descriptor

When you register an item or key, the item / key / change descriptor appears here. Mode descriptor is also displayed here.

#### ③ Amount / Quantity

This part of the display shows monetary amounts. It also can be used to show the current time. (The current date is shown in the alphanumeric display.)

#### ④ Taxable sales status indicators

When you register a taxable item, the corresponding indicator is lit.

#### ⑤ Number of repeats

Anytime you perform a repeat registration (page 29, 34), the number of repeats appears here.

Note that only one digit is displayed for the number of repeats. This means that a "5" could mean 5, 15 or even 25 repeats.

#### ⑥ Tendered amount

When the tender operation is made, the entered value appears here.

#### ⑦ Total / Change indicators









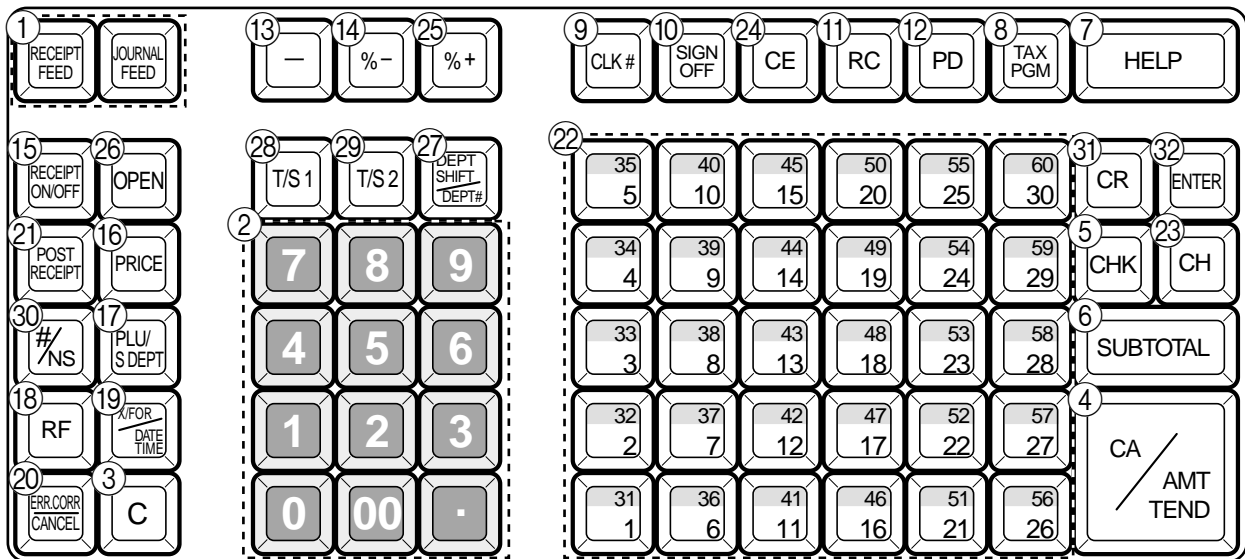

















When the TOTAL indicator is lit, the displayed value is monetary total or subtotal amount.

When the CHANGE indicator is lit, the displayed value is the change due.

# Introducing the Register

## Keyboard



- ① **Paper feed key**  ,   
Hold this key down to feed paper from the printer.
- ② **Ten key pad**  ,  , ~  ,  ,   
Use these keys to input numbers.
- ③ **Clear key**   
Use this key to clear an entry that has not yet been registered.
- ④ **Cash amount tendered key**   
Use this key to register a cash sale.
- ⑤ **Check key**   
Use this key to register a check tender.
- ⑥ **Subtotal key**   
Use this key to display and print the current subtotal (includes add-on tax) amount.
- ⑦ **Help key**   
Use this key to look up the procedures to set date/time, tax table etc.
- ⑧ **Tax program key**   
Use this key to set the tax status and tax table.
- ⑨ **Clerk number key**   
Use this key to sign clerk on and off the register.
- ⑩ **Sign off key**   
Use this key to sign clerk off the register.
- ⑪ **Received on account key**   
Use this key following a numeric entry to register money received for non-sale transactions.
- ⑫ **Paid out key**   
Use this key following a numeric entry to register money paid out from the drawer.
- ⑬ **Reduction (minus) key**   
Use this key to input values for reduction.
- ⑭ **Discount key**   
Use this key to register discounts.
- ⑮ **Receipt on/off key**   
Use this key twice to change the status “receipt issue” or “no receipt.”
- ⑯ **Price key**   
Use this key to register unit prices for subdepartment.
- ⑰ **PLU/Subdepartment key**   
Use this key to input PLU (subdepartment) numbers.
- ⑱ **Refund key**   
Use this key to input refund amounts and void certain entries.
- ⑲ **Multiplication/For/Date/Time key**   
Use this key to input a quantity for a multiplication and registration of split sales of packaged items. Between transactions, this key displays the current time and date.
- ⑳ **Error correct / Cancel key**   
Use this key to correct registration errors and to cancel registration of entire transactions.
- ㉑ **Post receipt key**   
Use this key to produce a post-finalization receipt.



- ② **Department keys** 1, 2, ~  
Use these keys to register items to departments.
- ③ **Charge key** CH  
Use this key to register a charge sale.
- ④ **Currency exchange key** CE  
Use this key for calculating subtotal amounts or paying amount due in foreign currency.
- ⑤ **Premium key** %+  
Use this key to register premiums.
- ⑥ **Open key** OPEN  
Use this key to temporarily release a limitation on the number of digits that can be input for a unit price.
- ⑦ **Department no. / Department shift key** DEPT#  
DEPT  
SHIFT  
Department no.: Use this key to input department numbers.  
Department shift: Use this key to shift the department key number from 1 through 30 to 31 through 60.  

<span style="border: 1px solid black; padding: 2px;">1</span> ⇨ Dept 01	<span style="border: 1px solid black; padding: 2px;">DEPT# DEPT SHIFT</span> <span style="border: 1px solid black; padding: 2px;">1</span> ⇨ Dept 31
<span style="border: 1px solid black; padding: 2px;">2</span> ⇨ Dept 02	<span style="border: 1px solid black; padding: 2px;">DEPT# DEPT SHIFT</span> <span style="border: 1px solid black; padding: 2px;">2</span> ⇨ Dept 32
:	:
- ⑧ **Tax shift 1 key** T/S1  
Use this key without a numeric entry to change the Taxable 1 status of the next item.
- ⑨ **Tax shift 2 key** T/S2  
Use this key without a numeric entry to change the Taxable 2 status of the next item.

- ⑩ **Non-add / No sale key** #  
NS  
Non-add key: Use this key to print reference number (to identify a personal check, credit card, etc.) during a transaction, use this key after some numerical entries.  
No sale key: Use this key to open the drawer without registering anything.
- ⑪ **Credit key** CR  
Use this key to register a credit sale.
- ⑫ **Enter key** ENTRY  
(future use)

## How to read the printouts

- The journal / receipts are records of all transactions and operations.
- The contents printed on receipts and journal are almost identical.
- You can choose the journal skip function.

If the journal skip function is selected, the cash register will print the total amount of each transaction, and the details of premium, discount and reduction operations only, without printing department and PLU item registrations on the journal.

- The following items can be skipped on receipts and journal.
  - Taxable status
  - Taxable amount
  - Item counter

### Receipt Sample

<pre>*****  * THANK YOU * **  CALL AGAIN  ** *****  * COMMERCIAL MESSAGE * * COMMERCIAL MESSAGE * * COMMERCIAL MESSAGE * * COMMERCIAL MESSAGE *            New Year           Sale     1st Anniversary     10% OFF             HAPPY NEW YEAR  REG 03-06-2008 11:58 C01 0001 000123  1 DEPT001 T1 \$1.00 1 DEPT002 T1 \$2.00 5 DEPT003 \$5.00  7 No  TA1 \$3.00 TX1 \$0.15 TL \$8.15 CASH \$10.00 CG \$1.85  *** BOTTOM MESSAGE *** *** BOTTOM MESSAGE *** *** BOTTOM MESSAGE *** *** BOTTOM MESSAGE ***</pre>	<p>Logo message</p> <p>Commercial message</p> <p>Preset message *1</p> <p>Preset graphic *1</p> <p>Mode/Date/Time Clerk/Machine No. Consecutive No.</p> <p>Q'ty/Item</p> <p>Item counter</p> <p>Bottom message</p>
---	--

### Journal Sample (Item lines Included)

```
REG 03-06-2008 11:58
C01 0001 000123
1 DEPT001 T1 $1.00
1 DEPT002 T1 $2.00
5 DEPT003 $5.00

7 No

TA1 $3.00
TX1 $0.15
TL $8.15
CASH $10.00
CG $1.85

REG 03-06-2008 11:59
C01 0001 000124
1 DEPT001 T1 $1.00
1 DEPT012 T1 $1.00
5 DEPT003 $6.00

7 No

TA1 $2.00
TX1 $0.10
TL $8.10
CASH $10.00
CG $1.90

REG 03-06-2008 11:59
C01 0001 000124
```

### Journal Sample (by half height character)

```
REG 03-06-2008 11:58
C01 0001 000123
1 DEPT001 T1 $1.00
1 DEPT002 T1 $2.00
5 DEPT003 $5.00

7 No
TA1 $3.00
TX1 $0.15
TL $8.15
CASH $10.00
CG $1.85

REG 03-06-2008 11:59
C01 0001 000124
1 DEPT001 T1 $1.00
1 DEPT012 T1 $1.00
5 DEPT003 $6.00

7 No
TA1 $2.00
TX1 $0.10
TL $8.10
CASH $10.00
CG $1.90

REG 03-06-2008 11:59
C01 0001 000125
```

\*1 You can choose to print preset message and graphic at the top of the receipt or at the bottom of the receipt.

In the operation examples contained in this manual, the print samples are what would be produced if the roll paper is being used for receipts. They are not actual size. Actual receipts are 58 mm wide. Also, all sample receipts and journals are printout images.

---

# How to use your cash register

The following describes the general procedure you should use in order to get the most out of your cash register.

## BEFORE business hours...

---

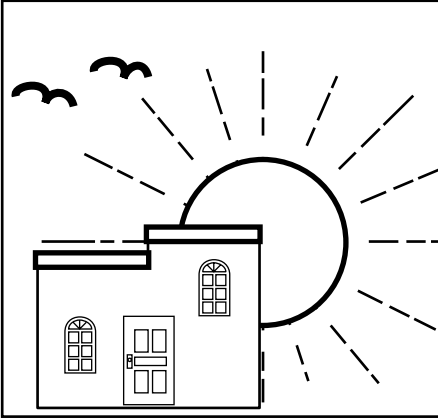

- Check to make sure that the cash register is plugged in securely. Page 13
- Check to make sure there is enough paper left on the roll. Pages 11, 12
- Read the flash report to confirm that totals are all zero. Page 75
- Check the date and time. Page 28

## DURING business hours...

---

- Register transactions. Page 29 -
- Periodically read totals. Page 74

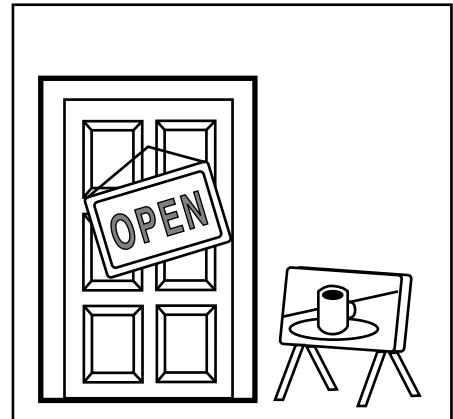

## AFTER business hours...

---

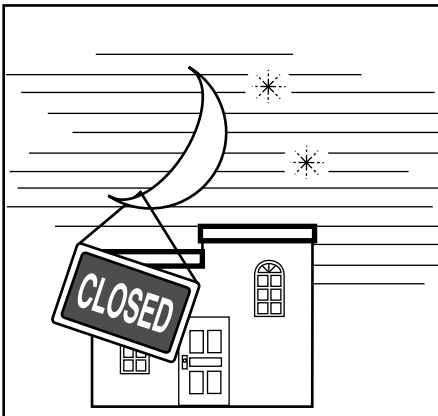

- Reset the daily totals. Page 45, 76
- Remove the journal. Page 90
- Empty the cash drawer and leave it open. Page 20
- Take the cash and journal to the office.

## Before business hours

### Checking the time and date

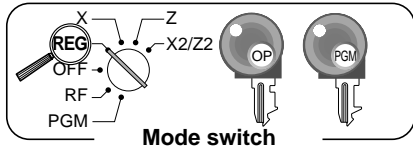

You can show the time or date on the display of the cash register whenever there is no registration being made.

### To display and clear the date/time

#### OPERATION

#### DISPLAY

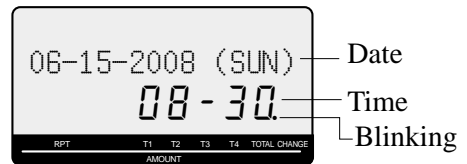

  
 Date/time appears on the display.



  
 Clears the date/time display.

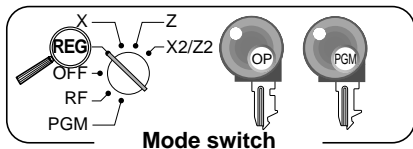

### Preparing coins for change



You can use the following procedure to open the drawer without registering an item. This operation must be performed out of a sale. (You can use the **RC** key instead of this key. See page 41.)

### Opening the drawer without a sale

#### OPERATION

#### RECEIPT



# Preparing and using department keys

## Registering department keys

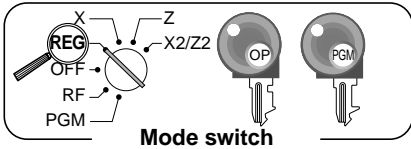

The following examples show how you can use the department keys in various types of registrations.

## Single item sale

### Example 1

#### OPERATION

#### RECEIPT

Item	Unit price	\$1.00
	Quantity	1
	Dept.	1
Payment	Cash	\$1.00

**1 00**  
Unit price

1 DEPT001	\$1.00	Department No./ unit price
TL	\$ 1 . 00	Total amount
CASH	\$1.00	

**1**

Department

CA/AMT  
/TEND

### Example 2 (Subtotal registration and change computation)

#### OPERATION

#### RECEIPT

Item	Unit price	\$12.34
	Quantity	1
	Dept.	1
Payment	Cash	\$20.00

**1 2 3 4**  
Unit price

1 DEPT001	\$12.34	Total amount
TL	\$ 12 . 34	Amount tendered
CASH	\$20.00	Change
CG	\$7.66	

**1**

Department

SUB  
TOTAL

**2 0 00** CA/AMT  
/TEND

Amount tendered

## Repeat

#### OPERATION

#### RECEIPT

Item	Unit price	\$1.50
	Quantity	3
	Dept.	1
Payment	Cash	\$10.00

**1 5 0** **1**

1 DEPT001	\$1.50	Repeat
1 DEPT001	\$1.50	Repeat
1 DEPT001	\$1.50	
TL	\$ 4 . 50	
CASH	\$10.00	
CG	\$5.50	

**1**

**1**

SUB  
TOTAL

**1 0 00** CA/AMT  
/TEND

# Basic Operations and Setups

## Multiplication

Item	Unit price	\$1.00
	Quantity	12
	Dept.	1
Payment	Cash	\$20.00

**OPERATION**

1 2 X / FOR  
DATE  
TIME  
 Quantity  
 (4-digit integer/3-digit decimal)

1 00 1  
SUB  
TOTAL

2 0 00 CA / AMT  
TEND

**RECEIPT**

12 DEPT001	\$12.00	Quantity/result
TL	\$ 12.00	
CASH	\$20.00	
CG	\$8.00	

## Split sales of packaged items

Item	Unit price	4 for \$10.00
	Quantity	3
	Dept.	1
	Taxable	No
Payment	Cash	\$10.00

**OPERATION**

3 X / FOR  
DATE  
TIME  
 Quantity being purchased  
 (4-digit integer/3-digit decimal)

4 X / FOR  
DATE  
TIME  
 Package quantity  
 (4-digit integer/3-digit decimal)

1 0 00 1  
 Package price SUB  
TOTAL

1 0 00 CA / AMT  
TEND

**RECEIPT**

3 DEPT001	\$7.50	Quantity/result
TL	\$ 7.50	
CASH	\$10.00	
CG	\$2.50	

## Department shift

Item	Unit price	\$1.00
	Quantity	1
	Dept.	31
Payment	Cash	\$1.00

**OPERATION**

DEPT#  
DEPT  
SHIFT 1 00 1  
 Designating upper department  
 press DEPT#  
DEPT  
SHIFT first.  
 (- 2 - shows).

CA / AMT  
TEND

**RECEIPT**

1 DEPT031	\$1.00
TL	\$ 1.00
CASH	\$1.00

## Department number

Item	Unit price	\$13.00
	Quantity	1
	Dept.	31
Payment	Cash	\$13.00

**OPERATION**

3 1 DEPT#  
DEPT  
SHIFT  
 Department No.

1 3 00 PRICE  
 Unit price

CA / AMT  
TEND

**RECEIPT**

1 DEPT031	\$13.00
TL	\$ 13.00
CASH	\$13.00

## Programming department keys

### To program a unit price for each department

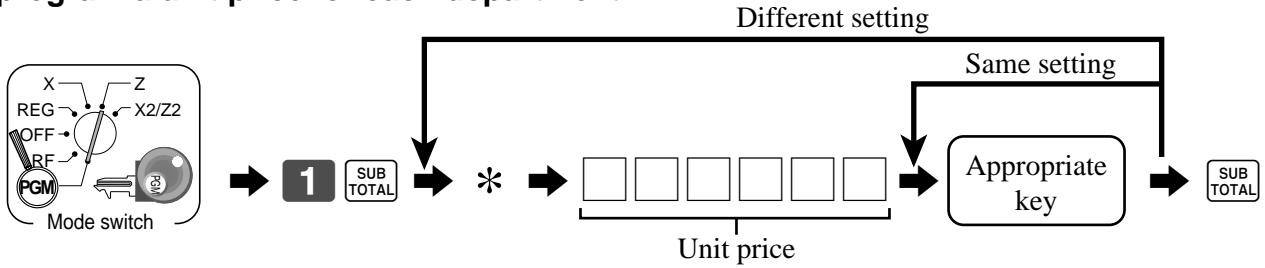

\* In case of shifting upper department, press key here.

### To program the tax calculation status for each department

#### Tax calculation status

This specification defines which tax table should be used for automatic tax calculation.

#### Programming procedure

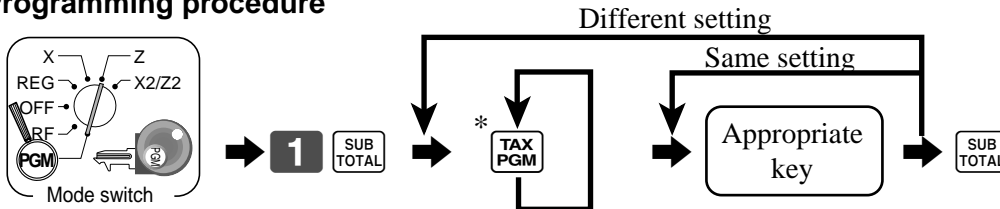

\* Press key repeatedly until the status you want to program is appeared on the display.



Appropriate key: In case of shifting department, press key first.

### To program high amount limit for each department

#### Programming procedure

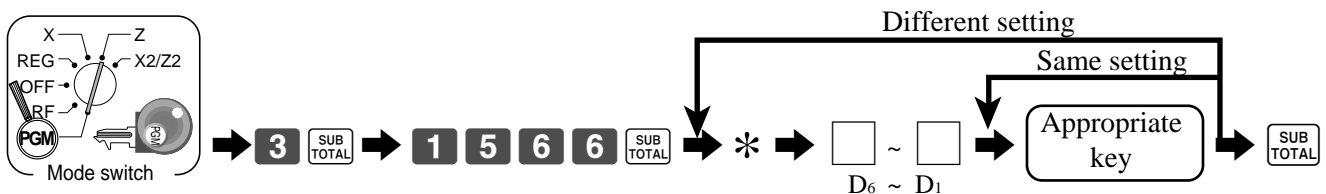

\* In case of shifting upper department, press key here.

Description	Choice	Program code
High amount limit for entering unit price manually.	Significant numbers	<input type="text"/> ~ <input type="text"/> D <sub>6</sub> ~ D <sub>1</sub>

# Basic Operations and Setups

## Registering department keys by programming data

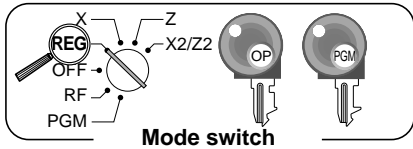

### Preset price

Item	Unit price	(\$1.00) <sub>preset</sub>
	Quantity	1
	Dept.	2
Payment	Cash	\$1.00

#### OPERATION

**2**  
CA/AMT  
TEND

#### RECEIPT

1 DEPT002	\$1.00
TL	\$1.00
CASH	\$1.00

Department No./  
unit price

### Preset tax status

Item 1	Unit price	(\$2.00) <sub>preset</sub>
	Quantity	5
	Dept.	3
	Taxable	(1) <sub>preset</sub>
Item 2	Unit price	(\$2.00) <sub>preset</sub>
	Quantity	1
	Dept.	4
	Taxable	(2) <sub>preset</sub>
Payment	Cash	\$20.00

#### OPERATION

**5**  FOR  
DATE TIME  
**3**  
**4**  
SUB  
TOTAL  
**2 0 0 0** CA/AMT  
TEND

#### RECEIPT

5 DEPT003	T1	\$10.00
1 DEPT004	T2	\$2.00
TA1		\$10.00
TX1		\$0.40
TA2		\$2.00
TX2		\$0.20
TL		\$12.60
CASH		\$20.00
CG		\$7.40

Tax status

Taxable Amount 1  
Tax 1  
Taxable Amount 2  
Tax 2

### Locking out high amount limitation

Item	Unit price	\$1.05
	Quantity	1
	Dept.	3
	Max.amount	(\$10.00) <sub>preset</sub>
Payment	Cash	\$2.00

#### OPERATION

**1 0 5 0** **3**  
**ERROR ALARM**  
(Exceeding high amount)  
**C**  
**1 0 5** **3**  
SUB  
TOTAL  
**2 0 0** CA/AMT  
TEND

#### RECEIPT

1 DEPT003	\$1.05
TL	\$1.05
CASH	\$2.00
CG	\$0.95



# Preparing and using PLUs

This section describes how to prepare and use PLUs.

## CAUTION:

Before you use PLUs, you must first program the unit price and tax status.

## Programming PLUs

### To program a unit price for each PLU

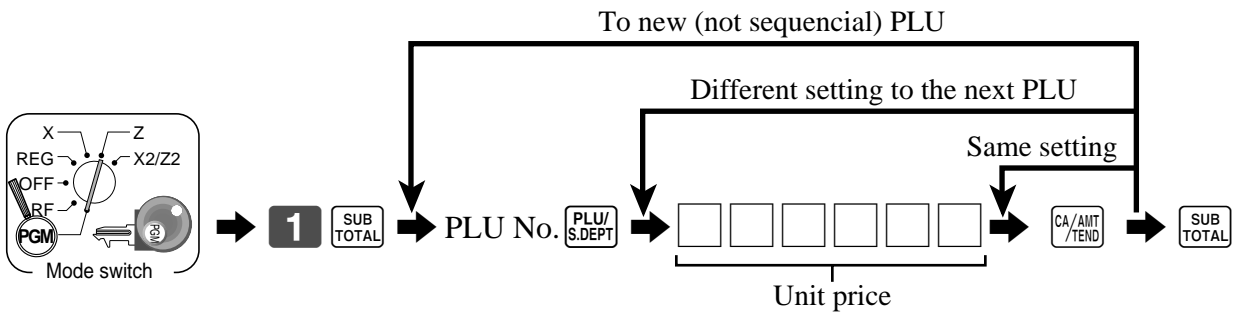

### To program tax calculation status for each PLU

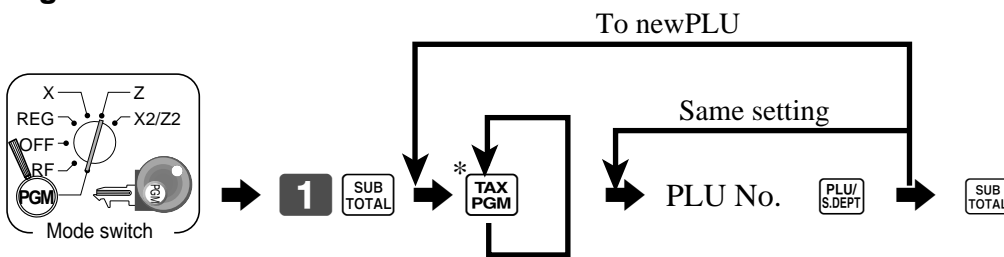

\* Press **TAX PGM** key repeatedly until the status you want to program is appeared on the display.



# Basic Operations and Setups

## Registering PLUs

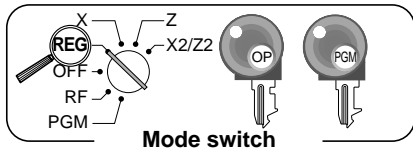

The following examples show how you can use PLUs in various types of registrations.

### PLU single item sale

#### OPERATION

Item	Unit price	(\$2.50) <sub>preset</sub>
	Quantity	1
	PLU	14
Payment	Cash	\$3.00

**1 4**  
PLU code

PLU/  
S.DEPT

SUB  
TOTAL

**3 00** CA/AMT  
TEND

#### RECEIPT

1 PLU0014	\$2.50	— PLU No./unit price
TL	\$2.50	
CASH	\$3.00	
CG	\$0.50	

### PLU repeat

#### OPERATION

Item	Unit price	(\$2.50) <sub>preset</sub>
	Quantity	3
	PLU	14
Payment	Cash	\$10.00

**1 4** PLU/  
S.DEPT

PLU/  
S.DEPT

PLU/  
S.DEPT

SUB  
TOTAL

**1 0 00** CA/AMT  
TEND

#### RECEIPT

1 PLU0014	\$2.50
1 PLU0014	\$2.50
1 PLU0014	\$2.50
TL	\$7.50
CASH	\$10.00
CG	\$2.50

### PLU multiplication

#### OPERATION

Item	Unit price	(\$2.00) <sub>preset</sub>
	Quantity	10
	PLU	7
Payment	Cash	\$20.00

**1 0** X / FOR  
DATE  
TIME  
Quantity  
(4-digit integer/3-digit decimal)

**7** PLU/  
S.DEPT

SUB  
TOTAL

**2 0 00** CA/AMT  
TEND

#### RECEIPT

10 PLU0007	\$20.00	— Quantity/result
TL	\$20.00	
CASH	\$20.00	
CG	\$0.00	

## Split sales of packaged item

### OPERATION

### RECEIPT

Item	Unit price	(5for\$20.00) <small>preset</small>
	Quantity	3
	PLU	28
Payment	Cash	\$15.00

**3**  FOR DATE TIME

Quantity being purchased  
(4-digit integer/3-digit decimal)

**5**  FOR DATE TIME

Package quantity  
(4-digit integer/3-digit decimal)

**2 8**  PLU/S.DEPT

SUB TOTAL

**1 5 00**  CA/AMT/TEND

3 PLU0028	\$12.00	Quantity/result
TL	\$12.00	
CASH	\$15.00	
CG	\$3.00	

## Open PLU

### OPERATION

### RECEIPT

Item 1	Unit price	\$32.80
	Quantity	1
	PLU	30
Item 2	Unit price	\$13.00
	Quantity	2
	PLU	31
Payment	Cash	\$60.00

**3 0**  PLU/S.DEPT

**3 2 8 0**  PRICE

Unit price

**3 1**  PLU/S.DEPT

**1 3 00**  PRICE

Repeat  PRICE

SUB TOTAL

**6 0 00**  CA/AMT/TEND

1 PLU0030	\$32.80
1 PLU0031	\$13.00
1 PLU0031	\$13.00
TL	\$58.80
CASH	\$60.00
CG	\$1.20

- Before registering an open PLU, it is necessary to preset it as an open PLU.

## Preparing and using discounts

This section describes how to prepare and register discounts.

### Programming discounts

To program a rate to the **%-** key

**Example:** 10.0% ⇒ **1 0**                      5.5% ⇒ **5 . 5**  
 12.34% ⇒ **1 2 . 3 4**

To program the tax calculation status to the **%-** key

Refer to page 31.

### Registering discounts

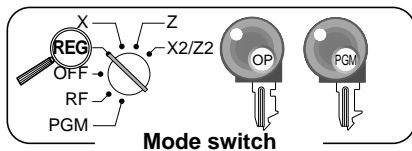

The following example shows how you can use the **%-** key in various types of registration.

### Discount for items and subtotals

	OPERATION	RECEIPT																																																																							
<table border="1" style="width: 100%; border-collapse: collapse;"> <tr> <td style="width: 15%;">Item 1</td> <td style="width: 15%;">Dept. 1</td> <td style="width: 15%;">\$5.00</td> </tr> <tr> <td></td> <td>Quantity</td> <td>1</td> </tr> <tr> <td></td> <td>Taxable</td> <td>(1)<sub>preset</sub></td> </tr> <tr> <td style="vertical-align: top;">Item 2</td> <td>PLU 16</td> <td>(\$10.00)<sub>preset</sub></td> </tr> <tr> <td></td> <td>Quantity</td> <td>1</td> </tr> <tr> <td></td> <td>Taxable</td> <td>(2)<sub>preset</sub></td> </tr> <tr> <td>Discount</td> <td>Rate</td> <td>(5%)<sub>preset</sub></td> </tr> <tr> <td rowspan="2">Subtotal discount</td> <td>Rate</td> <td>3.5%</td> </tr> <tr> <td>Taxable</td> <td>Nontaxable</td> </tr> <tr> <td>Payment</td> <td>Cash</td> <td>\$15.00</td> </tr> </table>	Item 1	Dept. 1	\$5.00		Quantity	1		Taxable	(1) <sub>preset</sub>	Item 2	PLU 16	(\$10.00) <sub>preset</sub>		Quantity	1		Taxable	(2) <sub>preset</sub>	Discount	Rate	(5%) <sub>preset</sub>	Subtotal discount	Rate	3.5%	Taxable	Nontaxable	Payment	Cash	\$15.00	<p><b>5 00</b> <b>1</b></p> <p><b>1 6</b> <b>PLU/S.DEPT</b></p> <p><b>%-</b></p> <p>Applies the preset discount rate to the last item registered.</p> <p><b>3 . 5</b> <b>%-</b></p> <p><b>SUB TOTAL</b></p> <p>The input value takes priority of the preset value.</p> <p><b>1 5 00</b> <b>CA/AMT/TEND</b></p>	<table style="width: 100%; border-collapse: collapse;"> <tr> <td style="width: 15%;">1 DEPT001</td> <td style="width: 15%;">T1</td> <td style="width: 15%;">\$5.00</td> </tr> <tr> <td>1 PLU0016</td> <td>T2</td> <td>\$10.00</td> </tr> <tr> <td></td> <td>5%</td> <td></td> </tr> <tr> <td>%-</td> <td>T2</td> <td>-0.50</td> </tr> <tr> <td>ST</td> <td></td> <td>\$14.50</td> </tr> <tr> <td></td> <td>3.5%</td> <td></td> </tr> <tr> <td>%-</td> <td></td> <td>-0.51</td> </tr> <tr> <td>TA1</td> <td></td> <td>\$5.00</td> </tr> <tr> <td>TX1</td> <td></td> <td>\$0.20</td> </tr> <tr> <td>TA2</td> <td></td> <td>\$9.50</td> </tr> <tr> <td>TX2</td> <td></td> <td>\$0.48</td> </tr> <tr> <td>TL</td> <td></td> <td><b>\$ 14 . 67</b></td> </tr> <tr> <td>CASH</td> <td></td> <td>\$15.00</td> </tr> <tr> <td>CG</td> <td></td> <td>\$0.33</td> </tr> </table>	1 DEPT001	T1	\$5.00	1 PLU0016	T2	\$10.00		5%		%-	T2	-0.50	ST		\$14.50		3.5%		%-		-0.51	TA1		\$5.00	TX1		\$0.20	TA2		\$9.50	TX2		\$0.48	TL		<b>\$ 14 . 67</b>	CASH		\$15.00	CG		\$0.33
Item 1	Dept. 1	\$5.00																																																																							
	Quantity	1																																																																							
	Taxable	(1) <sub>preset</sub>																																																																							
Item 2	PLU 16	(\$10.00) <sub>preset</sub>																																																																							
	Quantity	1																																																																							
	Taxable	(2) <sub>preset</sub>																																																																							
Discount	Rate	(5%) <sub>preset</sub>																																																																							
Subtotal discount	Rate	3.5%																																																																							
	Taxable	Nontaxable																																																																							
Payment	Cash	\$15.00																																																																							
1 DEPT001	T1	\$5.00																																																																							
1 PLU0016	T2	\$10.00																																																																							
	5%																																																																								
%-	T2	-0.50																																																																							
ST		\$14.50																																																																							
	3.5%																																																																								
%-		-0.51																																																																							
TA1		\$5.00																																																																							
TX1		\$0.20																																																																							
TA2		\$9.50																																																																							
TX2		\$0.48																																																																							
TL		<b>\$ 14 . 67</b>																																																																							
CASH		\$15.00																																																																							
CG		\$0.33																																																																							

- You can manually input rates up to 4 digits long (0.01% to 99.99%).

### Taxable status of the **%-** key

- Whenever you perform a discount operation on the last item registered, the tax calculation for discount amount is performed in accordance with the tax status programmed for that item.
- Whenever you perform a discount operation on a subtotal amount, the tax calculation for the subtotal amount is performed in accordance with the tax status programmed for the **%-** key.

# Preparing and using reductions

This section describes how to prepare and register reductions.

## Programming for reductions

You can use the **[-]** key to reduce single item or subtotal amounts.

### To program preset reduction amount

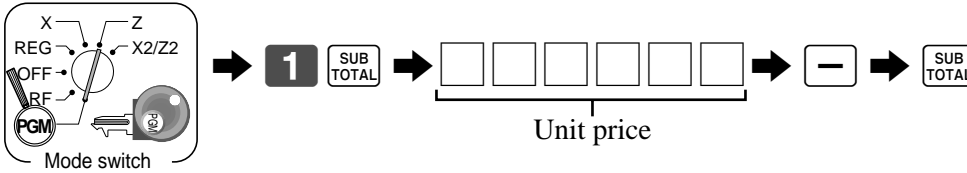

### To program the tax calculation status to the **[-]** key

Refer to page 31.

## Registering reductions

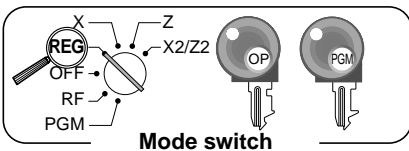

The following examples show how you can use the **[-]** key in various types of registration.

### Reduction for items and subtotal

			OPERATION	RECEIPT
Item 1	Dept. 1	\$5.00	<b>5 00</b> <b>1</b>	<pre> 1 DEPT001  T1  \$5.00 -          T1  -0.25 1 PLU0045  T1  \$6.00 -          T1  -0.50 -          -0.75 TA1                \$10.25 TX1                \$0.41 TL                 \$9.91 CASH               \$10.00 CG                 \$0.09                     </pre>
	Quantity	1	<b>2 5</b> <b>[-]</b>	
	Taxable	(1) <sub>preset</sub>	<b>4 5</b> <b>PLU/S.DEPT</b>	
Reduction	Amount	\$0.25	<b>[-]</b>	
Item 2	PLU 45	(\$6.00) <sub>preset</sub>	<b>SUB TOTAL</b>	
	Quantity	1	<b>7 5</b> <b>[-]</b>	
	Taxable	(1) <sub>preset</sub>	<b>1 0 00</b> <b>CA/AMT/TEND</b>	
Reduction	Amount	(\$0.50) <sub>preset</sub>		
Subtotal	Amount	\$0.75		
Reduction	Taxable	(No) <sub>preset</sub>		
Payment	Cash	\$10.00		

- You can manually input reduction values up to 7 digits long.
- If you want to subtract the reduction amount from the department or PLU totalizer, program “Net totaling.”

## Registering credit and check payments

The following examples show how to register credits and payments by check.

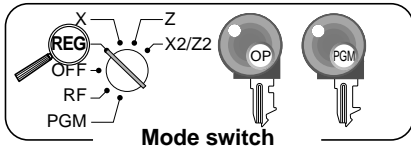

### Check

Item	Dept. 1	\$11.00
	Quantity	1
Reference	Number	1234
Payment	Check	\$20.00

#### OPERATION

1 1 00 1  
 SUB TOTAL  
 1 2 3 4 #/NS  
 2 0 00 CHK

#### RECEIPT

1 DEPT001	\$11.00	Reference No.
#/NS	1234	
TL	\$ 11.00	
CHECK	\$20.00	
CG	\$9.00	

### Charge

Item	Dept. 4	\$15.00
	Quantity	1
Payment	Charge	\$15.00

#### OPERATION

1 5 00 4  
 SUB TOTAL  
 CH

#### RECEIPT

1 DEPT004	\$15.00
TL	\$ 15.00
CHARGE	\$15.00

### Credit

Item	Dept. 3	\$10.00
	Quantity	1
Payment	Credit	\$10.00

#### OPERATION

1 0 00 3  
 SUB TOTAL  
 CR

#### RECEIPT

1 DEPT003	\$10.00
TL	\$ 10.00
CREDIT	\$10.00

### Mixed tender (cash and check)

Item	Dept. 4	\$55.00
	Quantity	1
Payment	Check	\$30.00
	Cash	\$25.00

#### OPERATION

5 5 00 4  
 SUB TOTAL  
 3 0 00 CHK  
 2 5 00 CA/AMT TEND

#### RECEIPT

1 DEPT004	\$55.00
TL	\$ 55.00
CHECK	\$30.00
CASH	\$25.00
CG	\$0.00

# Shifting the taxable status of an item

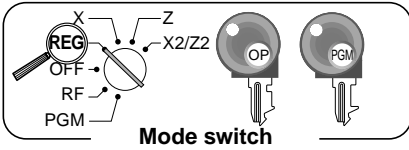

By pressing “Tax Shift” key, you can shift the taxable status of an item.

## Calculation merchandise subtotal

			OPERATION	DISPLAY
Item 1	Dept. 1	\$4.00	<b>4 00</b> <b>1</b>	
	Quantity	1	<b>T/S1</b>	
	Taxable	(2) <sub>preset</sub>	<b>2 00</b> <b>2</b>	
			Pressing <b>T/S1</b> changes the tax status from Nontaxable to Taxable 1	
Item 2	Dept. 2	\$2.00	<b>T/S2</b>	
	Quantity	1	<b>6 00</b> <b>3</b>	
	Taxable	(No)→1	<b>T/S2</b>	
			Pressing <b>T/S2</b> changes the tax status from Taxable 1 to Taxable 1, 2	
Item 3	Dept. 3	\$6.00	<b>7 00</b> <b>4</b>	
	Quantity	1	<b>T/S2</b>	
	Taxable	(1)→1, 2	<b>T/S2</b>	
			Pressing <b>T/S2</b> changes the tax status from Taxable 2 to Nontaxable	
Item 4	Dept. 4	\$7.00	<b>SUB TOTAL</b>	
	Quantity	1	<b>2 0 00</b> <b>CA/AMT/TEND</b>	
	Taxable	(2)→No		
Payment	Cash	\$20.00		

## OPERATION

## RECEIPT

1	DEPT001	T2	\$4.00
1	DEPT002	T1	\$2.00
1	DEPT003	T12	\$6.00
1	DEPT004		\$7.00
	TA1		\$8.00
	TX1		\$0.32
	TA2		\$10.00
	TX2		\$0.50
	TL		\$19.82
	CASH		\$20.00
	CG		\$0.18

### Important!

- To change the tax status of the next item to be registered, be sure to press **T/S1**, **T/S2**.  
If the last item registered is programmed as nontaxable, a discount (**%-** key) operation on this item is always nontaxable.  
In this case, you cannot manually change the tax status to Taxable 1 or 2 by pressing the **T/S1**, **T/S2** keys.

## Registering returned goods in the REG mode

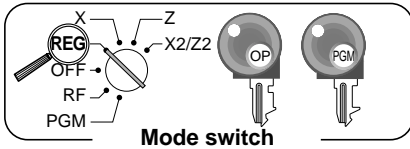

The following example shows how to use the **RF** key in the REG mode to register goods returned by customers.

### OPERATION

### RECEIPT

Item 1	Dept. 1	\$2.35
	Quantity	1
Item 2	Dept. 2	\$2.00
	Quantity	1
Item 3	PLU 1 (\$1.20) <sub>preset</sub>	
	Quantity	1
Returned Item 1	Dept. 1	\$2.35
	Quantity	1
Returned Item 3	PLU 1 (\$1.20) <sub>preset</sub>	
	Quantity	1
Payment	Cash	\$2.00

**2 3 5 1**

**2 00 2**

**1** **PLU/S.DEPT**

**RF**

**2 3 5 1**

Press **RF** before the item you want to return.

**RF**

**1** **PLU/S.DEPT**

**SUB TOTAL**

**CA/AMT TEND**

1	DEPT001	\$2.35
1	DEPT002	\$2.00
1	PLU0001	\$1.20
	RF	.....
1	DEPT001	-2.35
	RF	.....
1	PLU0001	-1.20
	TL	<b>\$2.00</b>
	CASH	\$2.00

## Registering returned goods in the RF mode

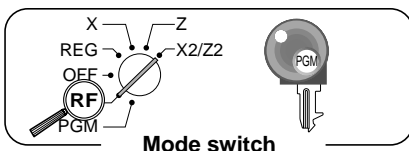

The following examples show how to use the RF mode to register goods returned by customers.

### OPERATION

### RECEIPT

Returned Item 1	Dept. 3	\$4.00
	Quantity	1
Reduction	Amount	\$0.15
Returned Item 2	PLU 2 (\$1.20) <sub>preset</sub>	
	Quantity	1
Discount	Rate	(5%) <sub>preset</sub>
Payment	Cash	\$4.99

**4 00 3**

**1 5 -**

**2** **PLU/S.DEPT**

**%-**

**SUB TOTAL**

**CA/AMT TEND**

1	DEPT003	\$4.00
	-	-0.15
1	PLU0002	\$1.20
	5%	
	%-	-0.06
	TL	<b>\$4.99</b>
	CASH	\$4.99

### Important

- To avoid miss registrations in the RF mode, return the mode switch to the former position immediately.



## Registering money received on account

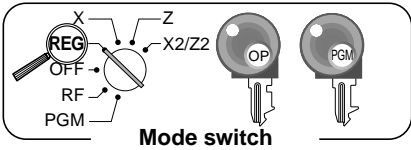

The following example shows how to register money received on account. This registration must be performed out of a sale.

Received amount	\$700.00
-----------------	----------

**OPERATION**

**7 00 00** RC

Amount can be up to 8 digits.

**RECEIPT**

RC	\$700.00
----	----------

## Registering money paid out

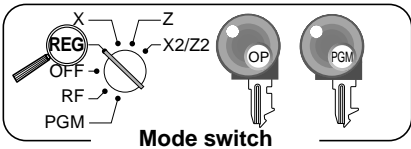

The following example shows how to register money paid out from the register. This registration must be performed out of a sale.

Paid out amount	\$1.50
-----------------	--------

**OPERATION**

**1 5 0** PD

Amount can be up to 8 digits.

**RECEIPT**

PD	\$1.50
----	--------

## No sale registration

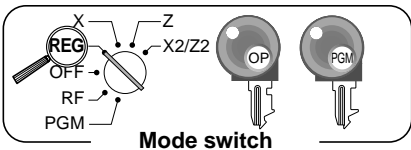

You can use the following procedure to open the drawer without registering a sale. This operation must be performed out of a sale.

**OPERATION**

#/NS

**RECEIPT**

#/NS	.....
------	-------

## Making corrections in a registration

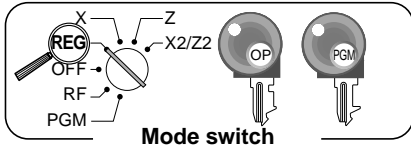

There are three techniques you can use to make corrections in a registration.

- \$To correct an item that you input but not yet registered.
- \$To correct the last item you input and registered.
- \$To cancel all items in a transaction.

### To correct an item you input but not yet registered

#### OPERATION

#### RECEIPT

<p><b>2 00</b></p> <p><b>1 00</b> <b>C</b></p> <p><b>1 2</b> <b>X / FOR</b> <b>DATE</b> <b>TIME</b></p> <p><b>1 1</b> <b>X / FOR</b> <b>DATE</b> <b>TIME</b></p> <p><b>2 00</b> <b>2</b></p> <p><b>2</b></p> <p><b>3</b> <b>PLU/</b> <b>S.DEPT</b></p> <p><b>1 5</b> <b>PLU</b></p> <p><b>6 00</b></p> <p><b>1 5</b> <b>PLU/</b> <b>S.DEPT</b></p> <p>Enter PLU No. again.</p> <p><b>1 0 00</b> <b>PRICE</b></p> <p><b>SUB</b> <b>TOTAL</b></p> <p><b>1 0 00</b></p> <p><b>1 5 00</b> <b>CA / AMT</b> <b>/ TEND</b></p> <p><b>CH</b></p>	<p>Correction of unit price</p> <p>Correction of quantity</p> <p>Correction of PLU No.</p> <p>Correction of open PLU unit price</p> <p>Correction of partial tender amount</p>	<table border="0"> <tr><td>1 DEPT001</td><td>\$1.00</td></tr> <tr><td>11 DEPT002</td><td>\$22.00</td></tr> <tr><td>1 PLU0003</td><td>\$1.30</td></tr> <tr><td>1 PLU0015</td><td>\$10.00</td></tr> <tr><td>TL</td><td><b>\$34.30</b></td></tr> <tr><td>CASH</td><td>\$15.00</td></tr> <tr><td>CHARGE</td><td>\$19.30</td></tr> </table>	1 DEPT001	\$1.00	11 DEPT002	\$22.00	1 PLU0003	\$1.30	1 PLU0015	\$10.00	TL	<b>\$34.30</b>	CASH	\$15.00	CHARGE	\$19.30
1 DEPT001	\$1.00															
11 DEPT002	\$22.00															
1 PLU0003	\$1.30															
1 PLU0015	\$10.00															
TL	<b>\$34.30</b>															
CASH	\$15.00															
CHARGE	\$19.30															

# To correct an item you input and registered

## OPERATION

## RECEIPT

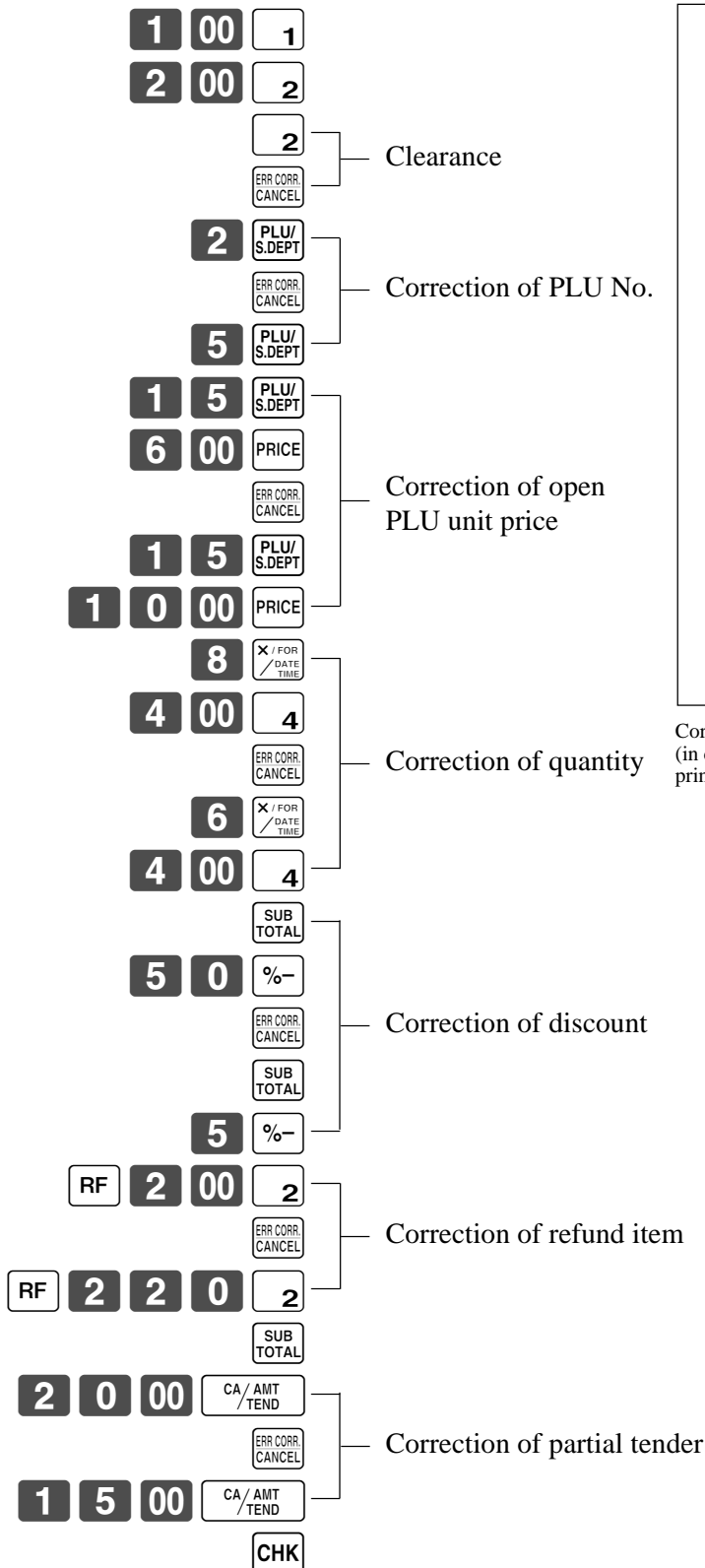

1	DEPT001	\$1.00
1	DEPT002	\$2.00
1	DEPT002	\$2.00
	CORR	-2.00
1	PLU0002	\$2.00
	CORR	-2.00
1	PLU0005	\$1.50
1	PLU0015	\$6.00
	CORR	-6.00
1	PLU0015	\$10.00
8	DEPT004	\$32.00
	CORR	-32.00
6	DEPT004	\$24.00
	ST	\$38.50
	50%	
	%-	-19.25
	CORR	\$19.25
	ST	\$38.50
	5%	
	%-	-1.93
	RF	.....
1	DEPT	-2.00
	CORR	\$2.00
	RF	.....
1	DEPT002	-2.20
	TL	\$34.37
	CASH	\$20.00
	CORR	-20.00
	CASH	\$15.00
	CHECK	\$19.37

Corrected items are not printed on receipt (in case of programming "Buffered receipt printing").

# Basic Operations and Setups

---

## To cancel all items in a transaction

OPERATION	RECEIPT																						
<table border="1"><tr><td>1</td><td>00</td><td>1</td></tr><tr><td>2</td><td>00</td><td>2</td></tr><tr><td>3</td><td>00</td><td>3</td></tr><tr><td>4</td><td>00</td><td>4</td></tr></table>	1	00	1	2	00	2	3	00	3	4	00	4	<table border="1"><tr><td>1 DEPT001</td><td>\$1.00</td></tr><tr><td>1 DEPT002</td><td>\$2.00</td></tr><tr><td>1 DEPT003</td><td>\$3.00</td></tr><tr><td>1 DEPT004</td><td>\$4.00</td></tr><tr><td>CANCEL</td><td>.....</td></tr></table>	1 DEPT001	\$1.00	1 DEPT002	\$2.00	1 DEPT003	\$3.00	1 DEPT004	\$4.00	CANCEL	.....
1	00	1																					
2	00	2																					
3	00	3																					
4	00	4																					
1 DEPT001	\$1.00																						
1 DEPT002	\$2.00																						
1 DEPT003	\$3.00																						
1 DEPT004	\$4.00																						
CANCEL	.....																						
<table border="1"><tr><td>SUB TOTAL</td></tr></table>	SUB TOTAL																						
SUB TOTAL																							
Pressing <table border="1"><tr><td>SUB TOTAL</td></tr></table> key is necessary to cancel the transaction.	SUB TOTAL																						
SUB TOTAL																							
<table border="1"><tr><td>ERR CORR. CANCEL</td></tr></table>	ERR CORR. CANCEL																						
ERR CORR. CANCEL																							

# Printing the daily sales reset report

This report shows daily sales totals.

## OPERATION

## REPORT

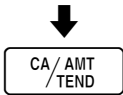
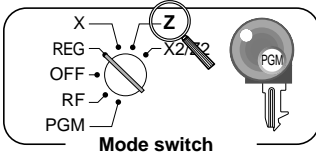

Z	03-06-2008 17:00	Date/time
	0001 000231	Machine No./consecutive No.
Z	DAILY Z	Report title
Z	DEPT 0001	Department report title/reset counter
	0001015	Report code
DEPT001	203.25	Department count/amount *1
	\$1,108.54	
DEPT002	183	Department count/amount *1
	\$1,362.26	
	5	
TL	421.25	Department total count/total amount
	\$2,872.28	
Z	FIX 0001	Fixed total report title/reset counter
	0001011	Report code
GROSS	981.25	Gross total *2
	\$6,574.40	
NET	No 111	Net total *2
	\$7,057.14	
CAID	\$1,919.04	Cash in drawer *2
CHID	\$139.04	Charge in drawer *2
CKID	\$859.85	Check in drawer *2
CRID(1)	\$709.85	Credit in drawer 1 *2
CRID(2)	\$0.00	Credit in drawer 2 *2
CRID(3)	\$0.00	Credit in drawer 3 *2
CRID(4)	\$0.00	Credit in drawer 4 *2
RF	No 3	Refund mode *2
	\$10.22	
CUST	CT 111	Number of customer *2
AVRG	\$63.57	Average sales per customer *2
DC	\$1.22	Discount total *2
REF	\$2.42	Refund key *2
ROUND	\$0.00	Rounding total *2
CANCEL	No 2	Cancellation *2
	\$12.97	

TA1	\$2,369.69	Taxable 1 amount *2
TX1	\$128.86	Tax 1 amount *2
TA2	\$2,172.96	Taxable 2 amount *2
TX2	\$217.33	Tax 2 amount *2
GT	\$00000000125478.96	Grand total *2
Z	TRANS 0001	Function key report title/reset counter
	0001012	Report code
CASH	No 362	Function key count/amount *1
	\$1,638.04	
CHARGE	No 56	Function key count/amount *1
	\$1,174.85	
RC	No 4	Function key count/amount *1
	\$810.00	
PD	No 5	Function key count/amount *1
	\$520.00	
	\$5.00	
CORR	No 14	Function key count/amount *1
	\$39.55	
RCT	No 3	Function key count/amount *1
	5	

\*1 Zero totalled departments/functions (the amount and item numbers are both zero) are not printed.

\*2 These items can be skipped by programming.

## Using clerk functions

### Enable clerk feature

Please follow the below procedure to enable clerk feature.

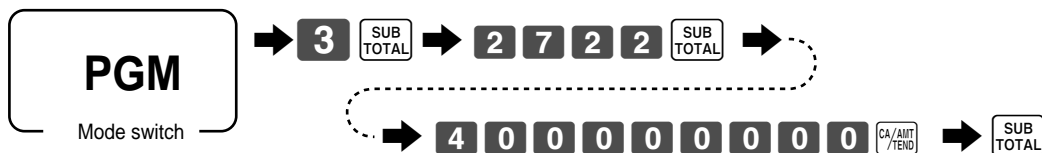

### Assigning a clerk

You can assign clerks by using clerk number.

#### Clerk number key

##### Clerk sign on

Signing clerk 1 on:

**1** →

Signing clerk 2 on:

**2** →

Clerk number :  
:

OPERATION	RECEIPT
	* COMMERCIAL MESSAGE *
	REG 03-06-2008 11:58
	C01 0001 000123
	1 DEPT01

Clerk name/machine No./consecutive No.

- If you do not want the clerk number to be shown on the display, press  before entering the number.

##### Clerk sign off

Signing clerk off:  
(except PGM mode)

- The current clerk is also signed off whenever you set the mode switch to OFF position.

### Important!

- The error code "E008" appears on the display whenever you try to perform a registration, a read/reset operation without signing on.
- The signed on clerk is also identified on the receipt/journal.

# Single item cash sales

A department key or PLU programmed with single item sale status finalizes the transaction as soon as it is registered.

The single item sales function can only be used for cash sales.

## Example 1

OPERATION			RECEIPT											
	Dept. 1	\$1.00	<b>1</b>	<b>00</b>	<b>1</b>									
Item	Quantity	1	The transaction is immediately finalized.											
	Status	S.I.S												
Payment	Cash	\$1.00	<table style="width: 100%; border-collapse: collapse;"> <tr> <td style="width: 60%;">1 DEPT001</td> <td style="width: 10%; text-align: right;">\$1.00</td> <td style="width: 30%;"></td> </tr> <tr> <td>TL</td> <td style="text-align: right;">\$ 1.00</td> <td></td> </tr> <tr> <td>CASH</td> <td style="text-align: right;">\$1.00</td> <td></td> </tr> </table>			1 DEPT001	\$1.00		TL	\$ 1.00		CASH	\$1.00	
1 DEPT001	\$1.00													
TL	\$ 1.00													
CASH	\$1.00													

Department No./ unit price
Cash total amount

## Example 2

OPERATION			RECEIPT											
	Dept. 1	(\$1.00)	<b>3</b>	<input checked="" type="checkbox"/> FOR DATE TIME	<b>1</b>									
Item	Quantity	3	The transaction is immediately finalized.											
	Status	S.I.S												
Payment	Cash	\$3.00	<table style="width: 100%; border-collapse: collapse;"> <tr> <td style="width: 60%;">3 DEPT001</td> <td style="width: 10%; text-align: right;">\$3.00</td> <td style="width: 30%;"></td> </tr> <tr> <td>TL</td> <td style="text-align: right;">\$3.00</td> <td></td> </tr> <tr> <td>CASH</td> <td style="text-align: right;">\$3.00</td> <td></td> </tr> </table>			3 DEPT001	\$3.00		TL	\$3.00		CASH	\$3.00	
3 DEPT001	\$3.00													
TL	\$3.00													
CASH	\$3.00													

## Example 3

OPERATION			RECEIPT														
	Dept. 3	\$2.00	<b>2</b>	<b>00</b>	<b>3</b>												
Item 1	Quantity	1	The transaction is not finalized. Because another item is registered before the single item sales department.														
	Status	Normal															
Item 2	Dept. 1	(\$1.00)	<input type="checkbox"/> CA / AMT TEND														
	Quantity	1															
	Status	S.I.S	<table style="width: 100%; border-collapse: collapse;"> <tr> <td style="width: 60%;">1 DEPT003</td> <td style="width: 10%; text-align: right;">\$2.00</td> <td style="width: 30%;"></td> </tr> <tr> <td>1 DEPT001</td> <td style="text-align: right;">\$1.00</td> <td></td> </tr> <tr> <td>TL</td> <td style="text-align: right;">\$3.00</td> <td></td> </tr> <tr> <td>CASH</td> <td style="text-align: right;">\$3.00</td> <td></td> </tr> </table>			1 DEPT003	\$2.00		1 DEPT001	\$1.00		TL	\$3.00		CASH	\$3.00	
1 DEPT003	\$2.00																
1 DEPT001	\$1.00																
TL	\$3.00																
CASH	\$3.00																
Payment	Cash	\$3.00															

## Currency exchange function

When <CE> key is pressed, a current subtotal including tax is converted directly into foreign currency and the result is displayed, and the subsequent finalization is handled using the foreign currency. The currency exchange function is released by finalizing a transaction, partial tender operation, receipt issuance, or by pressing <SUBTOTAL>.

Before using the currency exchange function, it is necessary to program the conversion rate.

### Registering foreign currency

#### Full amount tender in foreign currency

\* Pre-programmed exchange rate: ¥ 100 = \$0.9524

#### Important!

Tenders in a foreign currency can be registered using the **CA/AMT/TEND** and **CHK** only. Other finalize keys cannot be used.

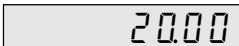
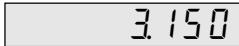
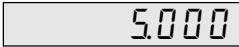
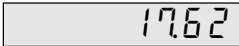
OPERATION	DISPLAY	RECEIPT														
<b>1 0 00</b> <b>1</b> ← Enter the unit price and press the applicable department key.	 (Displays in \$)	<table border="1"> <tr> <td>1 DEPT001</td> <td>\$10.00</td> </tr> <tr> <td>1 DEPT002</td> <td>\$20.00</td> </tr> <tr> <td>TL</td> <td>- 30.00</td> </tr> <tr> <td>CE</td> <td></td> </tr> <tr> <td>CASH</td> <td>¥5,000</td> </tr> <tr> <td>CASH</td> <td>\$47.62</td> </tr> <tr> <td>CG</td> <td>\$17.62</td> </tr> </table>	1 DEPT001	\$10.00	1 DEPT002	\$20.00	TL	- 30.00	CE		CASH	¥5,000	CASH	\$47.62	CG	\$17.62
1 DEPT001	\$10.00															
1 DEPT002	\$20.00															
TL	- 30.00															
CE																
CASH	¥5,000															
CASH	\$47.62															
CG	\$17.62															
<b>2 0 00</b> <b>2</b> ← Enter the next unit price and press the applicable department key.	 (Displays in \$)															
<b>CE</b> <b>SUB TOTAL</b> ← Press <b>CE</b> and <b>SUB TOTAL</b> without entering a numeric value. This operation converts the subtotal (including tax) dollar value into yen by applying a pre-programmed exchange rate. The result is shown on the display and printed on the receipt/journal by programming.	 (Displays in ¥: 3,150)															
<b>5 0 00</b> <b>CE</b> ← Enter the amount tendered in yen and press <b>CE</b> . This operation converts the entered yen amount into dollars by applying a pre-programmed exchange rate. The result is shown on the display. (5,000)	 (Displays in \$)															
<b>CA/AMT/TEND</b> ← Press to finalize the transaction. Note that you do not need to reenter the dollar amount. The register automatically calculates the change amount due in dollars and shows it on the display, receipts and journal.	 (Displays in \$)															



## Partial tender in a foreign currency

\* Pre-programmed exchange rate: ¥ 100 = \$0.9524

### Important!

Partial tender in a foreign currency can be registered using **CA/AMT/TEND** and **CHK** only. Other finalization keys cannot be used, but the remaining tender can be finalized using any finalize key.

#### OPERATION

#### DISPLAY

#### RECEIPT

**1 0 00** **1**

← Enter the unit price and press the applicable department key.

**10.00**  
(Displays in \$)

**2 0 00** **2**

← Enter the next unit price and press the applicable department key.

**20.00**  
(Displays in \$)

**CE** **SUB TOTAL**

← Press **CE** and **SUB TOTAL** without entering a numeric value. This operation converts the subtotal (including tax) dollar value into yen by applying a pre-programmed exchange rate. The result is shown on the display and printed on the receipt/journal by programming.

**3.150**  
(Displays in ¥: 3,150)

**2 0 00** **CE**  
(2,000)

← Enter the partial amount tendered in yen and press **CE**. This operation converts the entered yen amount into dollars by applying a pre-programmed exchange rate. The result is shown on the display.

**2.000**

**CA/AMT/TEND**

← Press **CA/AMT/TEND** to specify cash tender for the yen partial tender. Note that you do not need to reenter the dollar amount. The register automatically deducts the dollar equivalent of the yen amount tendered from the total amount due and shows the amount on the display.

**10.95**  
(Displays in \$)

**CHK/TEND**

← Press to finalize the transaction.

**10.95**  
(Displays in \$)

1	DEPT001	\$10.00
1	DEPT002	\$20.00
	TL	\$30.00
	CE	
	CASH	¥2,000
	CASH	\$19.05
	CHECK	\$10.95

# Advanced Operations and Setups

## Premium

### Example

#### OPERATION

#### RECEIPT

Item 1	Dept. 1	\$1.00
	Quantity	1
	Premium	10%
Item 2	Dept. 1	\$2.00
	Quantity	3
Subtotal	Premium	(15%)
Payment	Cash	\$8.17

1 DEPT001	\$1.00
10%	
%+	\$0.10
3 DEPT001	\$6.00
ST	\$7.10
15%	
%+	\$1.07
TL	<b>\$8.17</b>
CASH	\$8.17



## Programming department / PLU descriptors and preset messages in the list

In this chapter, the procedures to choose department / PLU descriptors and preset messages from the preset list are described. Read help receipt, so that you can set the descriptors and messages easily.

### How to choose and set the department / PLU descriptors in the list

1. Turn to the PGM mode.
2. Enter **0 7** and press the **HELP** key.
3. Select the item name and follow these steps in the list.

### How to choose and set the preset receipt message and graphic logo in the list

1. Turn to the PGM mode.
2. Enter **0 8** and press the **HELP** key. (Programming procedure and Preset message list is issued.)
3. Follow these steps in the list.

### Preset message and graphic print sample

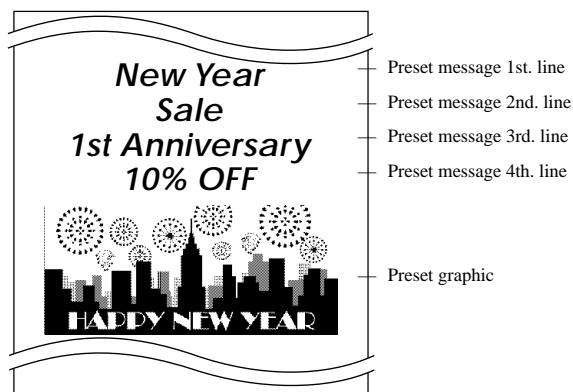

# Character manual input

This chapter shows the procedures to program department / PLU descriptors, store messages, key descriptors, report title, total descriptor (such as gross total, net total...) and clerk name.

The characters you entered by the character keyboard or multi-tapping keyboard, can be programmed.

The “Entering characters” section shows how to enter characters, and the “Programming descriptors and messages by entering characters” shows how to program the entered characters to each memory.

## Entering characters

In this section, the method to enter descriptors or messages (characters) to the cash register during programming is described.

Characters are specified by character keyboard or by multi tapping method. In the first half of this section, the usage of character keyboard is described. In the latter half, inputting method by multi tapping is described.

### Using character keyboard

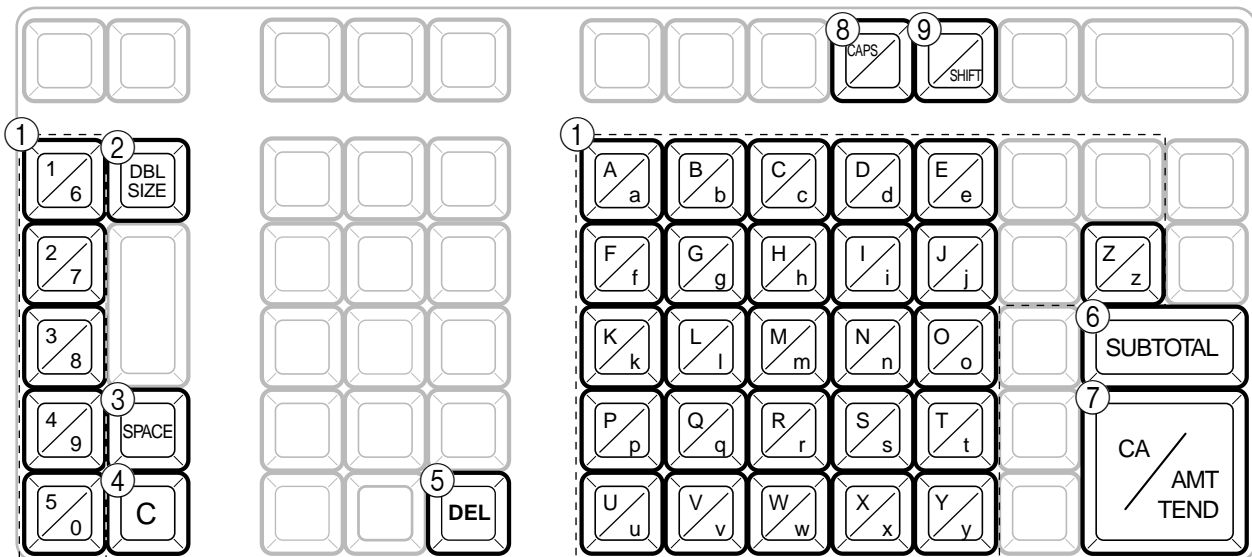

- ① **Alphabet keys**  
Used input to characters.
- ② **Double size letter key**  
Specifies that the next characters you input to double size characters. After completion of inputting double size character, press this key for normal size character.
- ③ **Space key**  
Set a space by depression.
- ④ **Clear key**  
Clears all input characters in the programming.
- ⑤ **Delete key**  
Clears the last input character, much like a back space key.
- ⑥ **Program end key**  
Terminates the character programming.
- ⑦ **Character enter key**  
Registers the programmed characters.
- ⑧ **CAPS key**  
Pressing this key shifts the character from the lowercase letter to upper case letter.
- ⑨ **Shift key**  
Pressing this key shifts the character from the uppercase letter to lower case letter.

**Example:**

Input “ **A** p p l e J u i c e ”,  
 enter <DBL><A> <DBL><Shift><p> <p> <l> <e> <Space> <CAPS><J> <Shift><u> <i> <c> <e> .



# Programming descriptors and messages by entering characters

The following descriptors and messages can be programmed;

- Report descriptor (such as gross total, net total, cash in drawer...)
- Grand total
- Special character (such as mode symbol, taxable symbol...)
- Read/reset report title
- Clerk name
- PLU item descriptor
- Messages (Logo, commercial and bottom message)
- Function key descriptor
- Department key descriptor

## Programming PLU descriptor

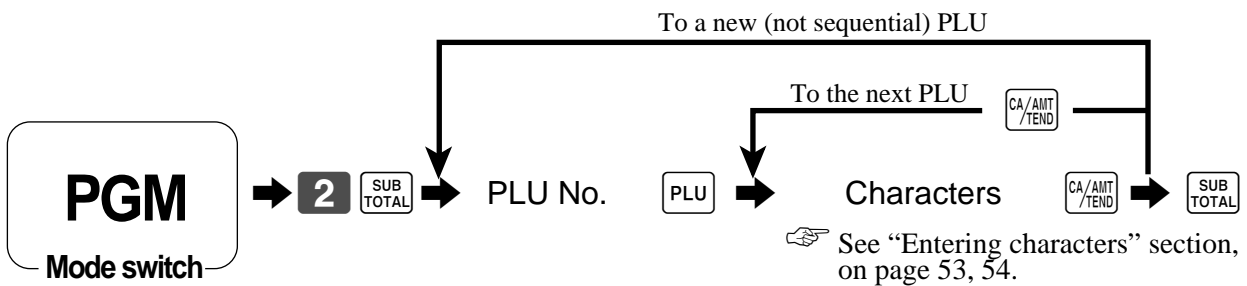

PLU No.	Contents	Initial character	Yours																	
0001	PLU0001	PLU0001																		
0002	PLU0002	PLU0002																		
0003	PLU0003	PLU0003																		
0004	PLU0004	PLU0004																		
0005	PLU0005	PLU0005																		
0006	PLU0006	PLU0006																		
0007	PLU0007	PLU0007																		
0008	PLU0008	PLU0008																		
0009	PLU0009	PLU0009																		
0010	PLU0010	PLU0010																		
0011	PLU0011	PLU0011																		
0012	PLU0012	PLU0012																		
0013	PLU0013	PLU0013																		
0014	PLU0014	PLU0014																		
0015	PLU0015	PLU0015																		
0016	PLU0016	PLU0016																		
0017	PLU0017	PLU0017																		
0018	PLU0018	PLU0018																		
0019	PLU0019	PLU0019																		
0020	PLU0020	PLU0020																		
0021	PLU0021	PLU0021																		
0022	PLU0022	PLU0022																		
0023	PLU0023	PLU0023																		
0024	PLU0024	PLU0024																		
0025	PLU0025	PLU0025																		
0026	PLU0026	PLU0026																		
0027	PLU0027	PLU0027																		
0028	PLU0028	PLU0028																		
0029	PLU0029	PLU0029																		
0030	PLU0030	PLU0030																		

# Advanced Operations and Setups

## Programming department / function key descriptor

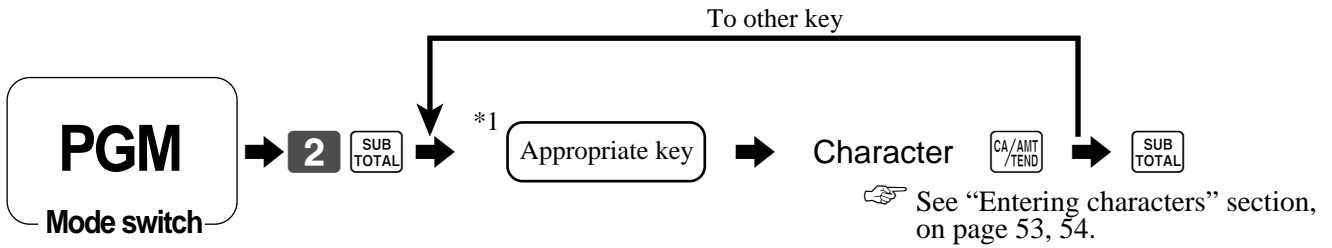

\*1 Appropriate key: In case of shifting department, press <DEPT SHIFT> key first.

## Function key

Contents	Initial character	Yours					
Cash/amount tendered	CASH						
Charge	CHARGE						
Check	CHECK						
Credit	CREDIT						
Received on account	RC						
Paid out	PD						
Minus	-						
Discount	%-						
Premium	%+						
Receipt on/off	RCT ON/OFF						
Post receipt	RCT						
Refund	RF						
Error correct/Cancel	CORR						
Sign off	SIGN-OFF						
Open	OPEN						
Department shift	SHIFT/No						
Multiplication/For/Date time	QT						
Tax shift 1	T/S1						
Tax shift 2	T/S2						
Non-add / No sale	#/NS						
Currency exchange	CE						

## Department key

Contents	Initial character	Yours					
Department 001	DEPT001						
Department 002	DEPT002						
Department 003	DEPT003						
Department 004	DEPT004						
Department 005	DEPT005						
Department 006	DEPT006						
Department 007	DEPT007						



## Programming message

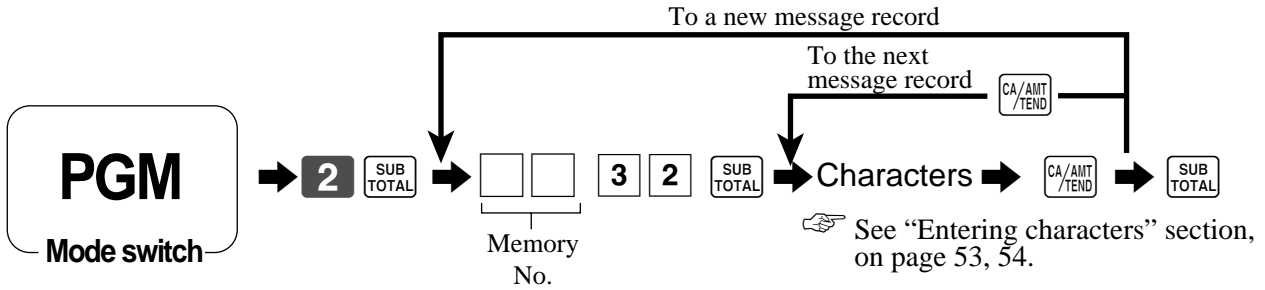

## Receipt message

Refer to “(message control)” on page 64.

Memory No.	Contents	Initial character	Yours
01	1st line of logo message	YOUR RECEIPT	
02	2nd line of logo message	THANK YOU	
03	3rd line of logo message	CALL AGAIN	
04	4th line of logo message		
05	1st line of commercial message		
06	2nd line of commercial message		
07	3rd line of commercial message		
08	4th line of commercial message		
09	1st line of bottom message		
10	2nd line of bottom message		
11	3rd line of bottom message		
12	4th line of bottom message		
:	:		
25	(not used)	DUPLICATE RECEIPT	
:	:		
40	Australian GST message 1st. line	TAX INVOICE	
41	Australian GST message 2nd. line	* INDICATES	
42	Australian GST message 3rd. line	TAXABLE SUPPLY	

## Programming Clerk name

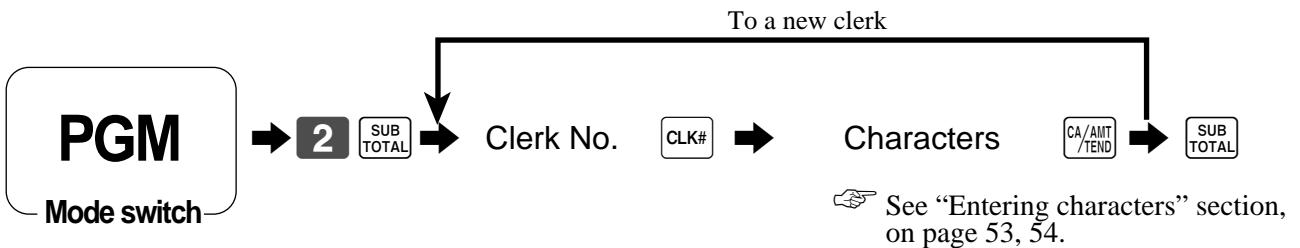

## Clerk name

Clerk No.	Contents	Initial character	Yours
01	Clerk 01	C01	
02	Clerk 02	C02	
03	Clerk 03	C03	
04	Clerk 04	C04	



## Grand total, special character

Memory No.	Program code	Contents	Initial character	Yours	
01	23	main currency symbol (2), @ (2), No. (2), split pricing (2), not used (4), sub currency symbol (2)	\$@ No/ **		
02		No. of item sold (2), No. of customer (2), not used (6), multiplication display (2)	NoCT @LB *QT		
03		multiplication (6) not used (6)	BUSY		
04		taxable symbol 1 (3 each) for tax 1, tax 2, tax 3, tax 4	T1 T2 T3 T4 T5		
06		taxable symbol 3 (3 each) for tax 1/2, tax 1/3, not used, not used, tax 2/3	T12T13T14 T23		
08		foreign currency (2 each), not used (8)	* * * * *		
09		mode symbol 1 (4 each) REG1/2, RF, not used	REG RFR		
10		mode symbol 2 (4 each) PGM, Daily X, Daily Z, Periodic	PnX Z XZ		
11		mode symbol 3 (4 each) not used, PGM read	TRG PGMX		
12		decimal: amount/q'ty, separator (main/sub) (1 each), not used (3), square (7)	. , . , . X		
13		A.M., P.M. (3 each), ST displayed on the dot display (2)	'AM 'PM 'ST		
16		display subtotal symbol (ST key) (16)	ST		
17		subtotal discount / premium symbol (16)	ST		
18		post receipt total symbol (16)	TL		
19		change symbol (16)	CG		
01		20	Grand total (16)	GT	

## Report title

Memory No.	Program code	Contents	Initial character	Yours
01	24	Fixed total report title	FIX	
02		Transaction key report title	TRANS	
03		PLU sales report title	PLU	
04		Department sales report title	DEPT	
05		Group sales report title	GROUP	
06		Clerk sales report title	CASHIER	
08		Hourly sales report title	HOURLY	
09		Monthly sales report title	MONTHLY	
16		Financial report title	FLASH	

## Machine feature program

### General control program

#### Programming procedure

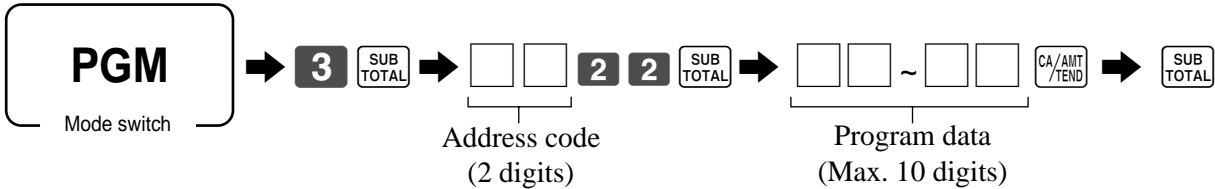

#### Program data (by address code)

##### Address code 02 (machine number)

Description	Choice	Program code	Initial value
Machine number	Significant numbers	<input type="text"/> <input type="text"/> <input type="text"/> <input type="text"/> D <sub>4</sub> D <sub>3</sub> D <sub>2</sub> D <sub>1</sub>	<input type="text"/> <input type="text"/> <input type="text"/> <input type="text"/> 0 0 0 0 D <sub>4</sub> D <sub>3</sub> D <sub>2</sub> D <sub>1</sub>

##### Address code 03 (consecutive number)

Description	Choice	Program code	Initial value
Reset consecutive number after daily reset report is issued.	Yes = 0 No = 1	<input type="text"/> D <sub>8</sub>	<input type="text"/> 0 D <sub>8</sub>
Always "00000000"		<input type="text"/> ~ <input type="text"/> D <sub>7</sub> ~ D <sub>1</sub>	<input type="text"/> ~ <input type="text"/> 0 ~ 0 D <sub>7</sub> ~ D <sub>1</sub>

##### Address code 04 (tax system)

Description	Choice	Program code	Initial value
Tax system U.S. tax system = 1, Canadian tax system = 2	Significant number	<input type="text"/> D <sub>9</sub>	<input type="text"/> or <input type="text"/> 1 or 2 (U.S.) (Canada) D <sub>9</sub>
Always "00000000"		<input type="text"/> ~ <input type="text"/> D <sub>8</sub> ~ D <sub>1</sub>	<input type="text"/> ~ <input type="text"/> 0 ~ 0 D <sub>8</sub> ~ D <sub>1</sub>

## Address code 05 (print control for receipt)

Description		Choice	Program code	Initial value
Print total line during finalization.	a	Yes = 0 No = 1	<input type="checkbox"/>	<input type="checkbox"/> 0
Time system: ① 24 hour system, ② 12 hour system	b	① = 0 ② = 2	(a+b) D <sub>10</sub>	(a+b) D <sub>10</sub>
Buffered receipt print *1		No = 0 Yes = 2	<input type="checkbox"/> D <sub>9</sub>	<input type="checkbox"/> D <sub>9</sub>
Skip item lines on journal. (journal skip)		No = 0 Yes = 1	<input type="checkbox"/> D <sub>8</sub>	<input type="checkbox"/> D <sub>8</sub>
Always "000"			<input type="checkbox"/> <input type="checkbox"/> <input type="checkbox"/> D <sub>7</sub> D <sub>6</sub> D <sub>5</sub>	<input type="checkbox"/> <input type="checkbox"/> <input type="checkbox"/> D <sub>7</sub> D <sub>6</sub> D <sub>5</sub>
Print number of item sold. (item counter)	a	No = 0 Yes = 1	<input type="checkbox"/>	<input type="checkbox"/> 0
Print tax symbols.	b	Yes = 0 No = 2	(a+b) D <sub>4</sub>	(a+b) D <sub>4</sub>
Always "00"			<input type="checkbox"/> <input type="checkbox"/> D <sub>3</sub> D <sub>2</sub>	<input type="checkbox"/> <input type="checkbox"/> D <sub>3</sub> D <sub>2</sub>
Always "0".			<input type="checkbox"/> D <sub>1</sub>	<input type="checkbox"/> D <sub>1</sub>

\*1: Select "Yes" if you want to print receipts with watermarks.

## Address code 06 (calculation & operation control)

Description		Choice	Program code	Initial value
Follow the taxable status and commission status of previous item when +/- operation is performed.	a	Yes = 0 No = 1	<input type="checkbox"/>	<input type="checkbox"/> 0
Force a money declaration before read/reset operation.	b	No = 0 Yes = 4	(a+b) D <sub>10</sub>	(a+b) D <sub>10</sub>
Force to press <input type="checkbox"/> SUB <input type="checkbox"/> TOTAL before finalization	a	No = 0 Yes = 1	<input type="checkbox"/>	<input type="checkbox"/> 0
Allow credit balance while finalization.	b	Yes = 0 No = 2	(a+b+c) D <sub>9</sub>	(a+b+c) D <sub>9</sub>
Allow multiple refund operation.	c	Yes = 0 No = 4	<input type="checkbox"/>	<input type="checkbox"/> 0
Affect the result of +/-, %+/%- to the item. (Net totalling)		No = 0 Yes = 1	<input type="checkbox"/> D <sub>8</sub>	<input type="checkbox"/> D <sub>8</sub>
Include commission in net total.		Yes = 0 No = 2	<input type="checkbox"/> D <sub>7</sub>	<input type="checkbox"/> D <sub>7</sub>
Clear the key buffer when a receipt is issued. (REG mode only)	a	No = 0 Yes = 1	<input type="checkbox"/>	<input type="checkbox"/> 0
Sounds key catch tone.	b	Yes = 0 No = 2	(a+b+c) D <sub>6</sub>	(a+b+c) D <sub>6</sub>
Allow to issue post receipt, even if the original one is issued.	c	No = 0 Yes = 4	<input type="checkbox"/>	<input type="checkbox"/> 0
Always "00"			<input type="checkbox"/> <input type="checkbox"/> D <sub>5</sub> D <sub>4</sub>	<input type="checkbox"/> <input type="checkbox"/> D <sub>5</sub> D <sub>4</sub>
Always "0"			<input type="checkbox"/> D <sub>3</sub>	<input type="checkbox"/> D <sub>3</sub>
Use <00> key as <000> key.		<00> = 0 <000> = 4	<input type="checkbox"/> D <sub>2</sub>	<input type="checkbox"/> D <sub>2</sub>
Always "0".			<input type="checkbox"/> D <sub>1</sub>	<input type="checkbox"/> D <sub>1</sub>

# Advanced Operations and Setups

## Address code 08 (print control for fixed total report)

Description		Choice	Program code	Initial value
Print gross sales total on fixed total report (GROSS)	a	Yes = 0 No = 1	<input type="checkbox"/> (a+b+c) D <sub>10</sub>	<input type="checkbox"/> 0 (a+b+c) D <sub>10</sub>
Print net sales total on fixed total report (NET)	b	Yes = 0 No = 2		
Print cash in drawer total on fixed total report (CAID)	c	Yes = 0 No = 4		
Print charge in drawer total on fixed total report (CHID)		Yes = 0 No = 2	<input type="checkbox"/> D <sub>9</sub>	<input type="checkbox"/> 0 D <sub>9</sub>
Print check in drawer total on fixed total report (CKID)	a	Yes = 0 No = 1	<input type="checkbox"/> (a+b) D <sub>8</sub>	<input type="checkbox"/> 0 (a+b) D <sub>8</sub>
Print credit in drawer total on fixed total report (CRID(1) ~ (4))	b	Yes = 0 No = 4		
Always "0"			<input type="checkbox"/> 0 D <sub>7</sub>	<input type="checkbox"/> 0 D <sub>7</sub>
Print RF mode total on fixed total report (RF)		Yes = 0 No = 4	<input type="checkbox"/> D <sub>6</sub>	<input type="checkbox"/> 0 D <sub>6</sub>
Print the net number of customers on fixed total report (CUST)	a	Yes = 0 No = 1	<input type="checkbox"/> (a+b) D <sub>5</sub>	<input type="checkbox"/> 2 (a+b) D <sub>5</sub>
Print the average sales per customer on fixed total report (AVER)	b	Yes = 0 No = 2		
Always "0"			<input type="checkbox"/> 0 D <sub>4</sub>	<input type="checkbox"/> 0 D <sub>4</sub>
Print commission 1 total on fixed total report (C-1)	a	Yes = 0 No = 1	<input type="checkbox"/> (a+b+c) D <sub>3</sub>	<input type="checkbox"/> 7 (a+b+c) D <sub>3</sub>
Print commission 2 total on fixed total report (C-2)	b	Yes = 0 No = 2		
Print foreign currency cash in drawer and check in drawer totals on fixed total report (CECA1 ~ 2, CECK1 ~ 2)	c	Yes = 0 No = 4		
Print <MINUS>, <COUPON>, <%-> and mix & match operation net total on fixed total report (DC)	a	Yes = 0 No = 1	<input type="checkbox"/> (a+b+c) D <sub>2</sub>	<input type="checkbox"/> 3 (a+b+c) D <sub>2</sub>
Print <REFUND> and <VOID> operation net total on fixed total report (REF)	b	Yes = 0 No = 2		
Print nontaxable totals on fixed total report (NON TAX)	a	Yes = 0 No = 1	<input type="checkbox"/> (a+b+c) D <sub>1</sub>	<input type="checkbox"/> 3 (a+b+c) D <sub>1</sub>
Print rounding totals on fixed total report (ROUND)	b	Yes = 0 No = 2		
Print cancellation total on fixed total report (CANCEL)	c	Yes = 0 No = 4		

## Address code 10 (print control for taxable amount)

Description		Choice	Program code	Initial value
Print taxable amount 1 on receipt/journal.	a	Yes = 0 No = 1	<input type="checkbox"/> (a+b+c) D <sub>10</sub>	<input type="checkbox"/> 0 (a+b+c) D <sub>10</sub>
Print taxable amount 2 on receipt/journal.	b	Yes = 0 No = 2		
Print taxable amount 3 on receipt/journal.	c	Yes = 0 No = 4		
Print taxable amount 4 on receipt/journal.		Yes = 0 No = 1	<input type="checkbox"/> D <sub>9</sub>	<input type="checkbox"/> 0 D <sub>9</sub>
Always "00000000"			<input type="checkbox"/> ~ <input type="checkbox"/> D <sub>8</sub> ~ D <sub>1</sub>	<input type="checkbox"/> ~ <input type="checkbox"/> D <sub>8</sub> ~ D <sub>1</sub>

## Address code 14 (currency exchange control)

Description		Choice	Program code	Initial value
Monetary mode of CECA1 and CECK1 in fixed total report:		Significant number (0 ~ 9)	<input type="checkbox"/> D <sub>8</sub>	<input type="checkbox"/> 0 D <sub>8</sub>
Decimal for CECA1 and CECK1 in fixed total report: ① Period = 0, ② Comma = 1	a	① = 0 ② = 1	<input type="checkbox"/> (a+b) D <sub>7</sub>	<input type="checkbox"/> (a+b) D <sub>7</sub>
Separator for CECA1 and CECK1 in fixed total report: ① Comma = 0, ② Period = 1	b	① = 0 ② = 4		
Monetary mode of CECA2 and CECK2 in fixed total report:		Significant number (0 ~ 9)	<input type="checkbox"/> D <sub>6</sub>	<input type="checkbox"/> 0 D <sub>6</sub>
Decimal for CECA2 and CECK2 in fixed total report: ① Period = 0, ② Comma = 1	a	① = 0 ② = 1	<input type="checkbox"/> (a+b) D <sub>5</sub>	<input type="checkbox"/> (a+b) D <sub>5</sub>
Separator for CECA2 and CECK2 in fixed total report: ① Comma = 0, ② Period = 1	b	① = 0 ② = 4		
Always "0000"			<input type="checkbox"/> 0 <input type="checkbox"/> 0 <input type="checkbox"/> 0 <input type="checkbox"/> 0 D <sub>4</sub> D <sub>3</sub> D <sub>2</sub> D <sub>1</sub>	<input type="checkbox"/> 0 <input type="checkbox"/> 0 <input type="checkbox"/> 0 <input type="checkbox"/> 0 D <sub>4</sub> D <sub>3</sub> D <sub>2</sub> D <sub>1</sub>

## Address code 15 (print control for reports)

Description		Choice	Program code	Initial value
Zero skip department report.	a	Yes = 0 No = 1	<input type="checkbox"/> (a+b) D <sub>10</sub>	<input type="checkbox"/> (a+b) D <sub>10</sub>
Zero skip clerk report.	b	Yes = 0 No = 2		
Zero skip transaction report.	a	Yes = 0 No = 1	<input type="checkbox"/> (a+b+c) D <sub>9</sub>	<input type="checkbox"/> (a+b+c) D <sub>9</sub>
Zero skip PLU report.	b	Yes = 0 No = 2		
Zero skip hourly report.	c	Yes = 0 No = 4		
Zero skip group report.		Yes = 0 No = 1	<input type="checkbox"/> D <sub>8</sub>	<input type="checkbox"/> 0 D <sub>8</sub>
Always "00"			<input type="checkbox"/> 0 <input type="checkbox"/> 0 D <sub>7</sub> D <sub>6</sub>	<input type="checkbox"/> 0 <input type="checkbox"/> 0 D <sub>7</sub> D <sub>6</sub>
Print PLU number on the PLU report.		No = 0 Yes = 4	<input type="checkbox"/> D <sub>5</sub>	<input type="checkbox"/> 0 D <sub>5</sub>
Print sales ratio.	a	No = 0 Yes = 1	<input type="checkbox"/> (a+b) D <sub>4</sub>	<input type="checkbox"/> (a+b) D <sub>4</sub>
Issue double Z report.	b	No = 0 Yes = 2		
Always "000"			<input type="checkbox"/> 0 <input type="checkbox"/> 0 <input type="checkbox"/> 0 D <sub>3</sub> D <sub>2</sub> D <sub>1</sub>	<input type="checkbox"/> 0 <input type="checkbox"/> 0 <input type="checkbox"/> 0 D <sub>3</sub> D <sub>2</sub> D <sub>1</sub>

# Advanced Operations and Setups

## Address code 16 (print control for grand total)

Description	Choice	Program code	Initial value
Print consecutive number range of the day on daily fixed total report.	No = 0 Yes = 1	<input type="checkbox"/> D <sub>7</sub>	<input type="checkbox"/> D <sub>7</sub>
Always "00000"		<input type="checkbox"/> ~ <input type="checkbox"/> D <sub>6</sub> ~ D <sub>2</sub>	<input type="checkbox"/> ~ <input type="checkbox"/> D <sub>6</sub> ~ D <sub>2</sub>
Print grand total on daily sales reset report.	Yes = 0 No = 1	<input type="checkbox"/> D <sub>1</sub>	<input type="checkbox"/> D <sub>1</sub>

## Address code 17 (print control)

Description	Choice	Program code	Initial value
Print date on journal.	a Yes = 0 No = 2	<input type="checkbox"/> (a+b) D <sub>4</sub>	<input type="checkbox"/> (a+b) D <sub>4</sub>
Print consecutive number on receipt/journal.	b Yes = 0 No = 4		
Print time on receipt.	a Yes = 0 No = 1	<input type="checkbox"/> (a+b) D <sub>3</sub>	<input type="checkbox"/> (a+b) D <sub>3</sub>
Print time on journal.	b Yes = 0 No = 2		
Always "00"		<input type="checkbox"/> <input type="checkbox"/> D <sub>2</sub> D <sub>1</sub>	<input type="checkbox"/> <input type="checkbox"/> D <sub>2</sub> D <sub>1</sub>

## Address code 19 (receipt control)

Description	Choice	Program code	Initial value
Print receipt in double-height characters.	No = 0 Yes = 1	<input type="checkbox"/> D <sub>7</sub>	<input type="checkbox"/> D <sub>7</sub>
Always "000000"		<input type="checkbox"/> ~ <input type="checkbox"/> D <sub>6</sub> ~ D <sub>1</sub>	<input type="checkbox"/> ~ <input type="checkbox"/> D <sub>6</sub> ~ D <sub>1</sub>

## Address code 21 (message control)

Description	Choice	Program code	Initial value
Print graphic type logo. (If select "No", character type logo is printed.)	a No = 0 Yes = 2	<input type="checkbox"/> (a+b) D <sub>10</sub>	<input type="checkbox"/> (a+b) D <sub>10</sub>
Print watermark on receipt.	b Yes = 0 No = 4		
Always "000"		<input type="checkbox"/> <input type="checkbox"/> <input type="checkbox"/> D <sub>9</sub> D <sub>8</sub> D <sub>7</sub>	<input type="checkbox"/> <input type="checkbox"/> <input type="checkbox"/> D <sub>9</sub> D <sub>8</sub> D <sub>7</sub>
Print commercial message on receipts in REG/RF mode.	a No = 0 Yes = 1	<input type="checkbox"/> (a+b) D <sub>6</sub>	<input type="checkbox"/> (a+b) D <sub>6</sub>
Print bottom message on receipts in REG/RF mode.	b No = 0 Yes = 2		
Always "0000"		<input type="checkbox"/> <input type="checkbox"/> <input type="checkbox"/> <input type="checkbox"/> D <sub>5</sub> D <sub>4</sub> D <sub>3</sub> D <sub>2</sub>	<input type="checkbox"/> <input type="checkbox"/> <input type="checkbox"/> <input type="checkbox"/> D <sub>5</sub> D <sub>4</sub> D <sub>3</sub> D <sub>2</sub>
Always "0"		<input type="checkbox"/> D <sub>1</sub>	<input type="checkbox"/> D <sub>1</sub>



### Address code 27 (clerk control)

Description	Choice	Program code	Initial value
Enable clerk function.	No = 0 Yes = 4	<input type="checkbox"/> D <sub>9</sub>	<input type="checkbox"/> 0 D <sub>9</sub>
Always "00000000"		<input type="checkbox"/> 0 ~ <input type="checkbox"/> 0 D <sub>8</sub> ~ D <sub>1</sub>	<input type="checkbox"/> 0 ~ <input type="checkbox"/> 0 D <sub>8</sub> ~ D <sub>1</sub>

### Address code 30 (thermal printer control)

Description	Choice	Program code	Initial value
Print preset receipt message and graphic	a No = 0 Yes = 1	<input type="checkbox"/> (a+b) D <sub>5</sub>	<input type="checkbox"/> 0 (a+b) D <sub>5</sub>
Print preset receipt message and graphic: ① at the bottom of the receipt / ② at the top of the receipt	b ① = 0 ② = 2		
Journal compressed print (print by half height characters)	Yes = 0 No = 1	<input type="checkbox"/> D <sub>4</sub>	<input type="checkbox"/> 0 D <sub>4</sub>
Always "000"		<input type="checkbox"/> 0 <input type="checkbox"/> 0 <input type="checkbox"/> 0 D <sub>3</sub> D <sub>2</sub> D <sub>1</sub>	<input type="checkbox"/> 0 <input type="checkbox"/> 0 <input type="checkbox"/> 0 D <sub>3</sub> D <sub>2</sub> D <sub>1</sub>

### Address code 34 (backlight control)

Description	Choice	Program code	Initial value
Backlight	Available = 0 Not available = 1	<input type="checkbox"/> D <sub>4</sub>	<input type="checkbox"/> 0 D <sub>4</sub>
Always "000"		<input type="checkbox"/> 0 <input type="checkbox"/> 0 <input type="checkbox"/> 0 D <sub>3</sub> D <sub>2</sub> D <sub>1</sub>	<input type="checkbox"/> 0 <input type="checkbox"/> 0 <input type="checkbox"/> 0 D <sub>3</sub> D <sub>2</sub> D <sub>1</sub>

## Key function program

### Department key/PLU program (Batch feature programming)

#### Programming procedure

##### Department key

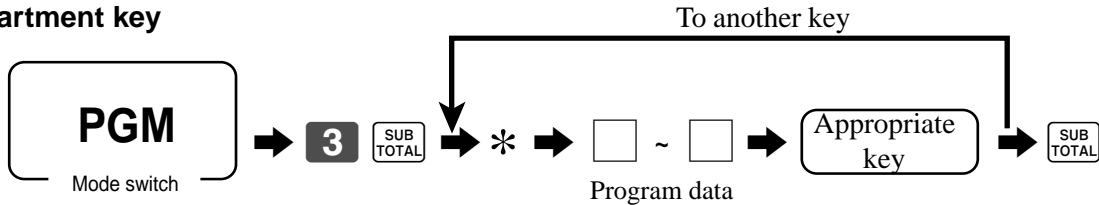

\*: In case of shifting department, press <DEPT SHIFT> key first.

##### PLU

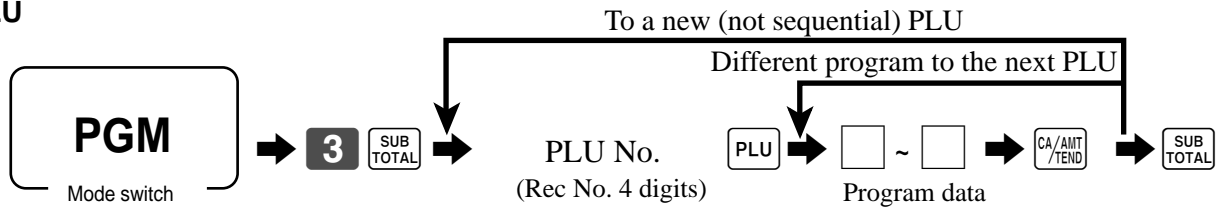

#### Program data

Description		Choice	Program code	Initial value
Single item control: Normal receipt = 0, Single item receipt = 3		Significant number	<input type="text"/> D <sub>12</sub>	<input type="text"/> D <sub>12</sub>
Always "0"			<input type="text"/> D <sub>11</sub>	<input type="text"/> D <sub>11</sub>
Always "0"			<input type="text"/> D <sub>10</sub>	<input type="text"/> D <sub>10</sub>
Always "0"			<input type="text"/> D <sub>9</sub>	<input type="text"/> D <sub>9</sub>
Taxable status: See page 68.			<input type="text"/> <input type="text"/> D <sub>8</sub> D <sub>7</sub>	<input type="text"/> <input type="text"/> D <sub>8</sub> D <sub>7</sub>
Enable 0 unit price.	a	No = 0 Yes = 1	<input type="text"/> (a+b+c) D <sub>6</sub>	<input type="text"/> (a+b+c) D <sub>6</sub>
Enable negative price.	b	No = 0 Yes = 2		
Hash	c	No = 0 Yes = 4		
Always "0"			<input type="text"/> D <sub>5</sub>	<input type="text"/> D <sub>5</sub>
Low digit limitation (LDL) for manually entered unit price.		Significant number	<input type="text"/> D <sub>4</sub>	<input type="text"/> D <sub>4</sub>
Open PLU (only for PLU)		No = 0 Yes = 4	<input type="text"/> D <sub>3</sub>	<input type="text"/> D <sub>3</sub>
Commission 1	a	No = 0 Yes = 1	<input type="text"/> (a+b) D <sub>2</sub>	<input type="text"/> (a+b) D <sub>2</sub>
Commission 2	b	No = 0 Yes = 2		
Always "0"			<input type="text"/> D <sub>1</sub>	<input type="text"/> D <sub>1</sub>

## Department key/PLU program (Individual feature programming)

### Programming procedure

#### Department key

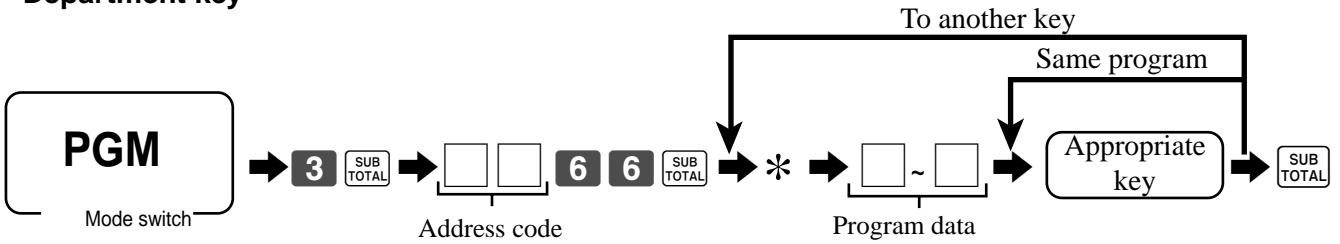

\*: In case of shifting department, press <DEPT SHIFT> key first.

#### PLU

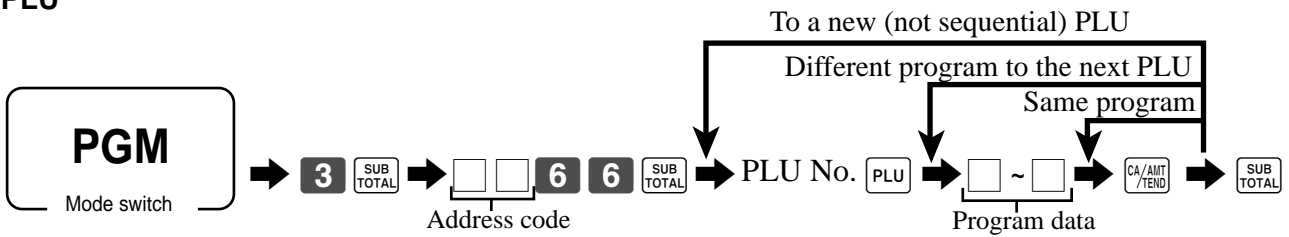

# Advanced Operations and Setups

## Program data (by address code)

### Address code 11 (link)

Description	Choice	Program code
Link group record number: (000 ~ 999)	Significant numbers	<input type="checkbox"/> <input type="checkbox"/> <input type="checkbox"/> D <sub>7</sub> D <sub>6</sub> D <sub>5</sub>
Always "0"		<input type="checkbox"/> <b>0</b> D <sub>4</sub>
Link department record number: (000 ~ 999) (only for PLU)	Significant numbers	<input type="checkbox"/> <input type="checkbox"/> <input type="checkbox"/> D <sub>3</sub> D <sub>2</sub> D <sub>1</sub>

### Address code 15 (high amount limit)

Description	Choice	Program code
High amount limit for entering unit price manually.	Significant numbers	<input type="checkbox"/> <input type="checkbox"/> <input type="checkbox"/> <input type="checkbox"/> <input type="checkbox"/> <input type="checkbox"/> D <sub>6</sub> D <sub>5</sub> D <sub>4</sub> D <sub>3</sub> D <sub>2</sub> D <sub>1</sub>

### Other address code

Address code	Description	Choice	Program code
<b>18</b>	Single item control: Normal receipt = 0, Single item receipt = 3	Significant number	<input type="checkbox"/>
<b>03</b>	Taxable status: See page 68.	Significant numbers	<input type="checkbox"/> <input type="checkbox"/> D <sub>2</sub> D <sub>1</sub>
<b>05</b>	Enable 0 unit price.	a	No = 0 Yes = 1
	Enable negative price.	b	No = 0 Yes = 2
	Hash	c	No = 0 Yes = 4
<b>07</b>	Low digit limitation (LDL) for manually entered unit price.	Significant number	<input type="checkbox"/>
<b>04</b>	Open PLU (Only for PLU)	No = 0 Yes = 4	<input type="checkbox"/>
<b>09</b>	Commission 1	a	No = 0 Yes = 1
	Commission 2	b	No = 0 Yes = 2

### Taxable status

for the U.S.

Always "0"			<input type="checkbox"/> <b>0</b> D <sub>8</sub>
Taxable 1 status	a	No = 0 Yes = 1	<input type="checkbox"/> (a+b+c) D <sub>7</sub>
Taxable 2 status	b	No = 0 Yes = 2	
Taxable 3 status	c	No = 0 Yes = 4	

for Canada

Always "0"			<input type="checkbox"/> <b>0</b> D <sub>8</sub>
Non tax = 0 Taxable 1 = 1 Taxable 2 = 2	Taxable 3 = 3 Taxable 4 = 4 Taxable 1 & 2 = 5	Taxable 1 & 3 = 6 Taxable 1 & 4 = 7	Significant number <input type="checkbox"/> D <sub>7</sub>

## Transaction key program

### Programming procedure

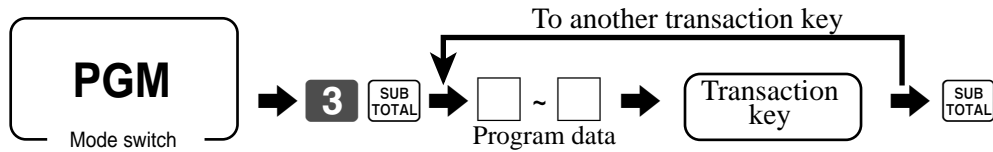

### Program data

<CASH>, <CHARGE>, <CHECK>

Description	Choice	Program code
Prohibit entry of a partial payment	a No = 0 Yes = 1	<input type="checkbox"/> (a+b+c) D <sub>7</sub>
Prohibit the entry of the amount tendered.	b No = 0 Yes = 2	
Force entry of the amount tendered.	c No = 0 Yes = 4	
Print VAT breakdown. *1	No = 0 Yes = 1	<input type="checkbox"/> D <sub>6</sub>
Always "0"		<input type="checkbox"/> D <sub>5</sub>
High amount limit specification for subtotal and tendering amounts.	Maximum value (0 ~ 9)	<input type="checkbox"/> <input type="checkbox"/> D <sub>4</sub> D <sub>3</sub>
	Number of zeros (0 ~ 9)	
High amount limit specification for change amount due.	Maximum value (0 ~ 9)	<input type="checkbox"/> <input type="checkbox"/> D <sub>2</sub> D <sub>1</sub>
	Number of zeros (0 ~ 9)	

\*1 This is valid option for Single item or Currency exchange (include partial tender) as well.

<RECEIVED ON ACCOUNT>, <PAID OUT>

Description	Choice	Program code
High amount limit specification for entering amounts	Maximum value (0 ~ 9)	<input type="checkbox"/> <input type="checkbox"/> D <sub>4</sub> D <sub>3</sub>
	Number of zeros (0 ~ 9)	
Always "00"		<input type="checkbox"/> <input type="checkbox"/> D <sub>2</sub> D <sub>1</sub>

# Advanced Operations and Setups

## <REDUCTION (MINUS)>

Description	Choice	Program code
Taxable status: See page 68.		<input type="checkbox"/> <input type="checkbox"/> D <sub>8</sub> D <sub>7</sub>
Allow credit balance. (-, CPN only)	No = 0 Yes = 1	<input type="checkbox"/> D <sub>6</sub>
Always "00"	No = 0 Yes = 2	<input type="checkbox"/> <input type="checkbox"/> D <sub>3</sub> D <sub>4</sub>
High digit limitation (HDL) for manually entered unit price ("9" means NOT allow manual entry.)		<input type="checkbox"/> D <sub>3</sub>
Commission 1	a	<input type="checkbox"/> (a+b) D <sub>2</sub>
Commission 2	b	
Always "0"	No = 0 Yes = 2	<input type="checkbox"/> <input type="checkbox"/> D <sub>1</sub>

## <PREMIUM (%+)>, <DISCOUNT (%-)>

Description	Choice	Program code
Taxable status: See page 68.		<input type="checkbox"/> <input type="checkbox"/> D <sub>8</sub> D <sub>7</sub>
Prohibit manual rate override.	No = 0 Yes = 2	<input type="checkbox"/> D <sub>6</sub>
Rounding: Round off = 0, cut off = 1, round up = 2	Significant number	<input type="checkbox"/> D <sub>5</sub>
Always "00"		<input type="checkbox"/> <input type="checkbox"/> D <sub>1</sub> D <sub>2</sub>
Commission 1	a	<input type="checkbox"/> (a+b) D <sub>2</sub>
Commission 2	b	
Always "0"		<input type="checkbox"/> <input type="checkbox"/> D <sub>1</sub>

## <NON-ADD (#)/NO SALE>

Description	Choice	Program code
Allow mode change or clerk change after non-add registration as first transaction. (only for non-add function)	Yes = 0 No = 1	<input type="checkbox"/> D <sub>7</sub>
Always "0000"		<input type="checkbox"/> <input type="checkbox"/> <input type="checkbox"/> <input type="checkbox"/> D <sub>6</sub> D <sub>5</sub> D <sub>4</sub> D <sub>3</sub>
Always "00"		<input type="checkbox"/> <input type="checkbox"/> D <sub>2</sub> D <sub>1</sub>

## <SUBTOTAL>, <MERCHANDISE SUBTOTAL>

Description	Choice	Program code
Print when key is pressed.	No = 0 Yes = 4	<input type="checkbox"/> D <sub>6</sub>
Always "00000"		<input type="checkbox"/> <input type="checkbox"/> <input type="checkbox"/> <input type="checkbox"/> <input type="checkbox"/> D <sub>5</sub> D <sub>4</sub> D <sub>3</sub> D <sub>2</sub> D <sub>1</sub>

**<CURRENCY EXCHANGE>**

Description		Choice	Program code
Define amount symbol. (0, 1 ~ 2) ("0" means local currency symbol.)		Significant number	<input type="checkbox"/> D <sub>7</sub>
Define foreign currency totalizer. (0, 1 ~ 2) ("0" treats as "1".)		Significant number	<input type="checkbox"/> D <sub>6</sub>
Rounding: Round off = 0, cut off = 1, round up = 2		Significant number	<input type="checkbox"/> D <sub>5</sub>
Always "0"			<input type="checkbox"/> D <sub>4</sub>
Monetary mode (0 ~ 9): □□□ = 2, □□ = 1, □ = 0, □□□□ = 3		Significant number	<input type="checkbox"/> D <sub>3</sub>
Monetary symbol for decimal	a	Decimal = 0 Comma = 1	<input type="checkbox"/> (a+b) D <sub>2</sub>
Monetary symbol for separator	b	Comma = 0 Decimal = 4	
Always "0"			<input type="checkbox"/> D <sub>1</sub>

**<MULTIPLICATION / FOR>**

Description		Choice	Program code
Multiplication procedure: (<X> only) ① Quantity × Amount, ② Amount × Quantity		① = 0 ② = 1	<input type="checkbox"/> D <sub>6</sub>
Rounding: Round off = 0, cut off = 1, round up = 2		Significant number	<input type="checkbox"/> D <sub>5</sub>
Always "0000"			<input type="checkbox"/> <input type="checkbox"/> <input type="checkbox"/> <input type="checkbox"/> D <sub>4</sub> D <sub>3</sub> D <sub>2</sub> D <sub>1</sub>

**<TAX SHIFT>**

Description		Choice	Program code
Taxable status (00, 01 ~ 04) ("00" means taxable 1.)		Significant numbers	<input type="checkbox"/> <input type="checkbox"/> D <sub>8</sub> D <sub>7</sub>
Always "000000"			<input type="checkbox"/> <input type="checkbox"/> <input type="checkbox"/> <input type="checkbox"/> <input type="checkbox"/> <input type="checkbox"/> D <sub>6</sub> D <sub>5</sub> D <sub>4</sub> D <sub>3</sub> D <sub>2</sub> D <sub>1</sub>

# Advanced Operations and Setups

## <CREDIT>

Description	Choice	Program code
Prohibit entry of a partial payment	a No = 0 Yes = 1	<input type="checkbox"/> (a+b+c) D <sub>7</sub>
Prohibit the entry of the amount tendered.	b No = 0 Yes = 2	
Force entry of the amount tendered.	c No = 0 Yes = 4	
Print VAT breakdown.	No = 0 Yes = 1	<input type="checkbox"/> D <sub>6</sub>
Always "0"		<input type="checkbox"/> 0 D <sub>5</sub>
High amount limit specification for subtotal and tendering amounts.	Maximum value (0 ~ 9)	<input type="checkbox"/> <input type="checkbox"/> D <sub>4</sub> D <sub>3</sub>
	Number of zeros (0 ~ 9)	
Always "0"		<input type="checkbox"/> 0 D <sub>2</sub>
Specify credit in drawer total in the fixed totalizer.	Significant number (0 ~ 4)	<input type="checkbox"/> D <sub>1</sub>

## Clerk program

### Clerk number, check number programming

#### Programming procedure

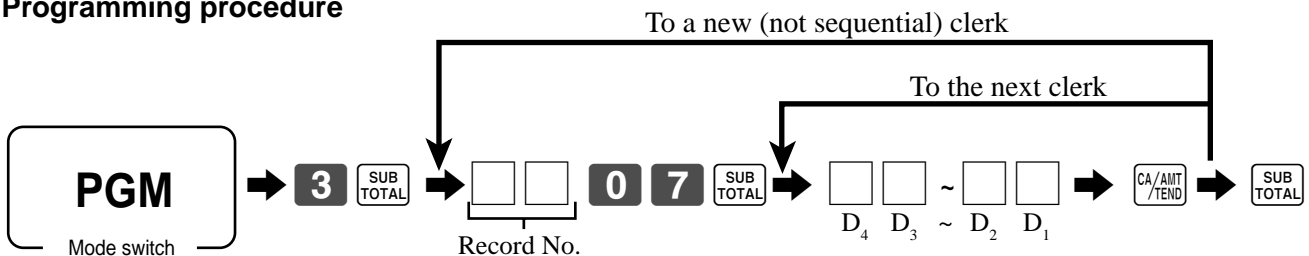

#### Program Data

Description	Choice	Program code
Clerk secret number	Significant numbers	<input type="checkbox"/> <input type="checkbox"/> <input type="checkbox"/> <input type="checkbox"/> D <sub>4</sub> D <sub>3</sub> D <sub>2</sub> D <sub>1</sub>



## Clerk other programming

### Programming procedure (individual)

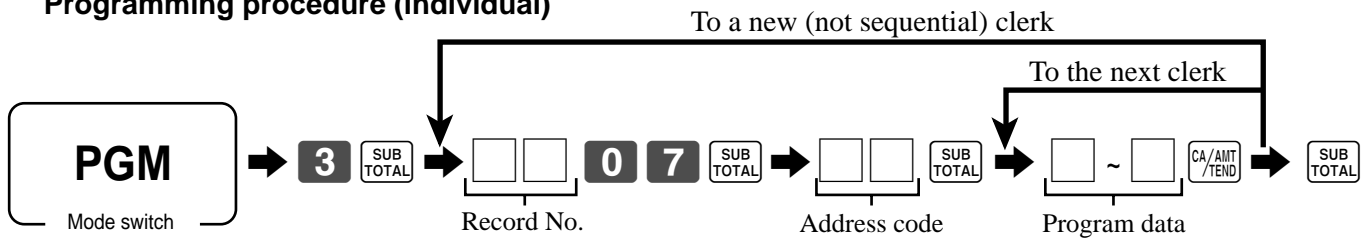

### Program data

#### Address code 67 (Clerk control)

Description	Choice	Program code
Training clerk	No = 0 Yes = 1	<input type="checkbox"/> D <sub>6</sub>
Always "00000"		<input type="text" value="0"/> <input type="text" value="0"/> D <sub>5</sub> ~ D <sub>1</sub>

#### Address code 68 (Commission rate)

Description	Choice	Program code
Commission rate 1 (integer: 00 ~ 99)	Significant numbers	<input type="text" value=""/> <input type="text" value=""/> D <sub>8</sub> D <sub>7</sub>
Commission rate 1 (decimal: 00 ~ 99)	Significant numbers	<input type="text" value=""/> <input type="text" value=""/> D <sub>6</sub> D <sub>5</sub>
Commission rate 2 (integer: 00 ~ 99)	Significant numbers	<input type="text" value=""/> <input type="text" value=""/> D <sub>4</sub> D <sub>3</sub>
Commission rate 2 (decimal: 00 ~ 99)	Significant numbers	<input type="text" value=""/> <input type="text" value=""/> D <sub>2</sub> D <sub>1</sub>

## Printing read/reset reports

- **Daily sales read report (“X” mode)**

You can print read reports at any time during the business day without affecting the data stored in the cash register's memory.

- **Daily sales reset report (“Z” mode)**

You should print reset reports at the end of the business day.

### Important!

- The reset operation issues a report and also clears all sales data from the cash register's memory.
- Be sure to perform the reset operations at the end of each business day. Otherwise, you will not be able to distinguish between the sales data for different dates.

### To print the individual department, PLU read report

This report shows sales for specific departments or PLUs.

OPERATION	DISPLAY
-----------	---------

1. Turn to X mode.

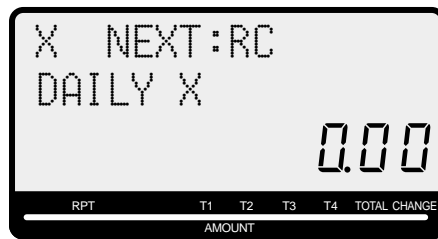
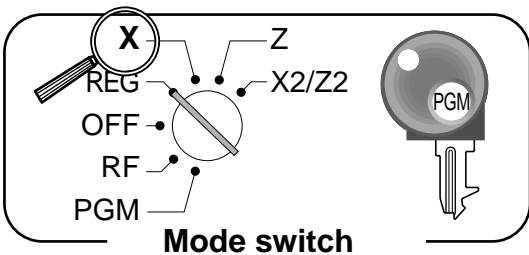

2. Specify a department / PLU .

- Specifying a department  
 ,  ,  ...
- Specifying a PLU  
  ,    ...

3. Press <ST> to exit this report.

### REPORT

X	INDIVIDUAL	Read symbol/report title
DEPT001	38	Department Name/No. of items
8.13%	\$257.53	Sales ratio/amount
PLU0001	17	PLU Name/No. of items
0.53%	\$17.00	Sales ratio/PLU amount
#0001		PLU code
-----		
TL	88.61	Total No. of items
	\$516.10	Total amount

## To print daily read reports

You can select the appropriate report shown in the display.

### OPERATION

1. Turn to X mode.

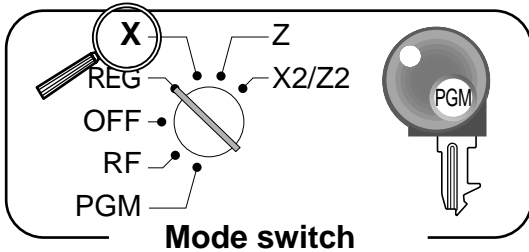

### DISPLAY

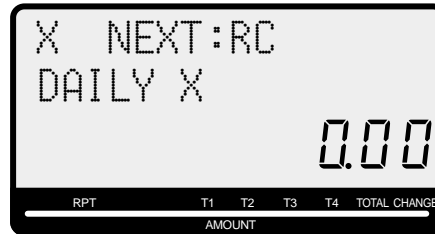

2. Select report you want to get by the <RC> key.



3. Press <CASH> to print report. \*1

- \*1 If money declaration is necessary, count how much cash is in the drawer and input this amount (up to 10 digits) and press <#/NS> key.

The cash register will automatically compare the input with the cash in drawer in the memory and print the difference between these two amounts.

Note that if money declaration is required by programming, you cannot skip this procedure.

# Advanced Operations and Setups

## To print daily reset reports

You can select the appropriate report shown in the display.

### OPERATION

1. Turn to Z mode.

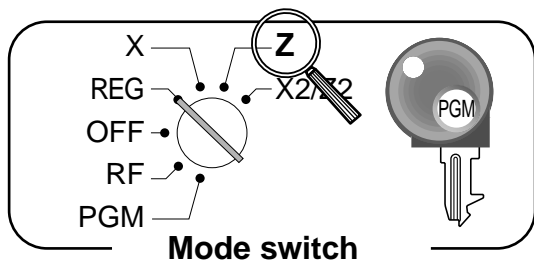

### DISPLAY



2. Select report you want to get by the <RC> key.



3. Press <CASH> to print report. \*1

\*1 If money declaration is necessary, count how much cash is in the drawer and input this amount (up to 10 digits) and press <#/NS> key.

The cash register will automatically compare the input with the cash in drawer in the memory and print the difference between these two amounts.

Note that if money declaration is required by programming, you cannot skip this procedure.

# Read / reset report sample

## Daily report

Z	DAILY			Report title
Z	DEPT	0001		Department report title/reset counter
		0001015		Report code
DEPT001		38		Department name/No. of items *2
8.13%		\$257.53		Sales ratio/amount *2
		183		
		\$1,362.26		
TL		88.61		Total No. of items
		\$1,916.10		Total amount
Z	FIX	0001		Fixed total report title/reset counter *4
		0001011		Report code
DECLA		\$6,919.04		Declared cash in drawer of main currency *1
		\$0.00		Difference (= declared - accumulated) *1
GROSS		981.25		Gross total *3
NET	No	111		Net total *3
		\$7,057.14		
CAID		\$6,919.04		Cash in drawer *3
CHID		\$139.04		Charge in drawer *3
CKID		\$859.85		Check in drawer *3
CRID(1)		\$709.85		Credit in drawer 1 *3
CRID(2)		\$0.00		Credit in drawer 1 *3
CRID(3)		\$0.00		Credit in drawer 1 *3
CRID(4)		\$0.00		Credit in drawer 1 *3
RF	No	3		Refund mode *3
		\$10.22		
CUST	CT	111		Customer number *3
AVRG		\$63.57		Average sales per customer *3

DC		\$1.22		Discount total *3
REF		\$2.42		Refund key *3
ROUND		\$0.00		Rounding total *3
CANCEL	No	2		Cancellation *3
		\$12.97		
TA1		\$2,369.69		Taxable 1 amount *3
TX1		\$128.86		Tax 1 amount *3
TA2		\$2,172.96		Taxable 2 amount *3
TX2		\$217.33		Tax 2 amount *3
GT		\$00000000125478.96		Grand total *3
Z	TRANS	0001		Function key report title/reset counter
		0001012		Report code
CASH	No	362		Function key count/amount *2
		\$1,638.04		
CHARGE	No	56		
		\$1,174.85		
RC	No	4		
		\$810.00		
PD	No	5		
		\$520.00		
		\$5.00		
CORR	No	14		
		\$39.55		
RET	No	3		
		5		
NS				
Z	CASHIER	0001		Clerk report title/reset counter
		0001017		Report code
C01		..... 1		Clerk name
NET	No	111		Net total
		\$1,845.35		
C02		..... 1		Clerk name/drawer No.

\*1 Zero totalled departments/functions (the amount and item numbers are both zero) are not printed.

\*2 These items can be skipped by programming.

# Advanced Operations and Setups

## Flash report

X	FLASH		0000071	Read symbol/report title
				Report code
DECLA		\$6,919.04		Main currency declared amount
		\$0.00		Difference
GROSS		111.15		Gross total
		\$7,054.14		
NET	No	120		Net total
		\$7,263.20		
CAID		\$6,919.04		Cash in drawer

## PLU report

X	PLU		0000014	Read symbol/report title
				Report code
PLU0001		17		PLU name/No. of items
0.53%		\$17.00		Sales ratio/PLU amount
#0001				PLU code
PLU0100		42		
		\$69.00		
#0100				
TL		188.61		Total No. of items
		\$516.10		Total amount

## Hourly report

X	HOURLY		0000019	Read symbol/report title
				Report code
00:00->01:00				Time range
	CT	1		No. of customers
GROSS		\$1.10		Gross sales amount
NET	No	1		No. of receipt
1.90%		\$1.20		Sales ratio/net sales amount
23:00->00:00				
	CT	1		
GROSS		\$3.45		
NET	No	1		
3.90%		\$3.59		
TL	CT	280		Total No. of customers
GROSS		\$1,937.61		Gross total amount
NET	No	25		Total No. of receipt
		\$2,096.80		Net total amount

## Monthly report

X	MONTHLY		0000020	Read symbol/report title
				Report code
1.....				Date of a month
GROSS		1236.76		Gross symbol/No. of items
		\$12,202.57		Gross sales amount
NET	No	214		Net symbol/No. of customers
		\$12,202.57		Net sales amount
31.....				
GROSS		2132		
		\$14,187.57		
NET	No	205		
		\$13,398.76		
TL				Total symbol
GROSS		9746.63		Gross symbol/No. of items
		\$161,022.49		Gross sales amount
		\$16.52		Average daily gross sales
NET	No	2351		Net symbol/No. of customers
		\$161,022.49		Net sales amount
		\$68.49		Average daily net sales

## Group report

X	GROUP	0000016	Read symbol/report title Report code
	GROUP01	203.25	Group No./No. of items
	33.87%	\$1,108.54	Sales ratio/group amount
	GROUP02	183	
	40.58%	\$1,327.80	
	GROUP03	12	
		\$13.25	
	GROUP99	12	
	0.54%	\$17.80	
	-----		
	TL	862	Group total No. of items
		\$3,272.00	Group total amount

# Advanced Operations and Setups

- **Periodic sales read report (“X2” mode)**

You can print read reports at any time during the business day without affecting the data stored in the cash register's memory.

- **Periodic sales reset report (“Z2” mode)**

You should print reset reports at the end of the business day.

## To print the periodic 1/2 sales read/reset reports

These reports show sales breakdowns of sales by any two kinds of period you want.

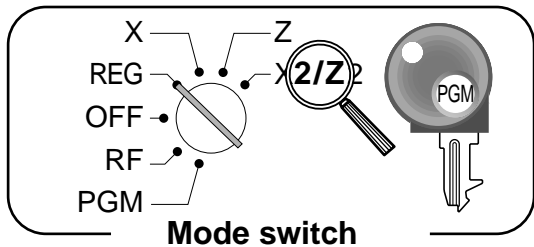
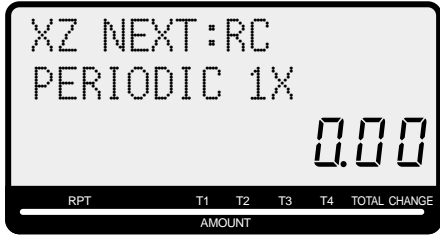
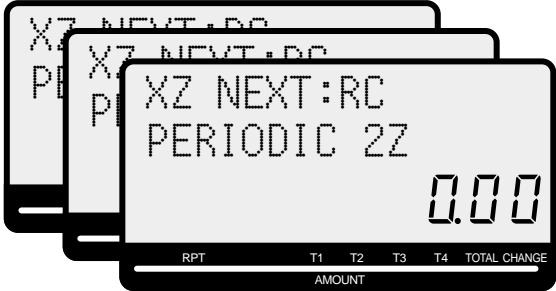
OPERATION	DISPLAY
<p>1. Turn to X2/Z2 mode.</p>  <p><b>Mode switch</b></p>	
<p>2. Select report you want to get by the &lt;RC&gt; key.</p>	
<p>3. Press &lt;CASH&gt; to print report.</p>	



-----		
ZZ1 PERIODIC 1Z		Report title
-----		
ZZ1 DEPT	0001	Department report title/reset counter
	0001115	Report code
-----		
DEPT001	38	Department Name/No. of items *1
8.13%	\$257.53	Sales ratio/amount *1
DEPT000	18	
-----		
	\$1,362.26	
-----		
TL	88.61	Total No. of items
	\$1,916.10	Total amount
-----		
ZZ1 FIX	0001	Fixed total report title/reset counter
	0001111	Report code
-----		
GROSS	981.25	Gross total *2
	\$6,574.40	
NET	No 111	Net total *2
	\$7,057.14	
CAID	\$6,919.04	Cash in drawer *2
CHID	\$139.04	Charge in drawer *2
CKID	\$859.85	Check in drawer *2
CRID(1)	\$709.85	Credit in drawer 1 *2
CRID(2)	\$0.00	Credit in drawer 2 *2
CRID(3)	\$0.00	Credit in drawer 3 *2
CRID(4)	\$0.00	Credit in drawer 4 *2
-----		
RF	No 3	Refund mode *2
	\$10.22	
CUST	CT 111	Customer number *2
AVRG	\$63.57	Average sales per customer *2
DC	\$1.22	Discount total *2
REF	\$2.42	Refund key *2
ROUND	\$0.00	Rounding total *2
CANCEL	No 2	Cancellation *2
	\$12.97	
-----		
TA1	\$2,369.69	Taxable 1 amount *2
TX1	\$128.86	Tax 1 amount *2
TA2	\$2,172.96	Taxable 2 amount *2
TX2	\$217.33	Tax 2 amount *2

-----		
ZZ1 TRANS	0001	Function key report title/reset counter
	0001112	Report code
-----		
CASH	No 362	Function key count/amount *1
	\$1,638.04	
CHARGE	No 56	
	\$1,174.85	
RC	No 4	
	\$810.00	
PD	No 5	
	\$5.00	
CORR	No 14	
	\$39.55	
BCT	No 3	
NS	5	
-----		
ZZ1 CASHIER	0001	Clerk report title/reset counter
	0001117	Report code
-----		
C01	..... 1	Clerk name
NET	No 111	Net total
	\$1,845.35	
-----		
C02	..... 1	Clerk name

\*1 Zero totalled departments/functions (the amount and item numbers are both zero) are not printed.

\*2 These items can be skipped by programming.

## Reading the cash register's program

### To print unit price/rate program (except PLU)

OPERATION	REPORT
<ol style="list-style-type: none"> <li>1. Turn to PGM mode.</li> <li>2. Enter &lt;1&gt; and press &lt;ST&gt; key.</li> <li>3. Press &lt;ST&gt; key.</li> </ol>	<p>                     P01..... Program read symbol                      CASH @0.00 Transaction key unit price or rate                      - @1.00                      % 10%                      DEPT001 0001-05 Department descriptor/rec-#/05                      @1.00 Unit price                      DEPT002 0002-05                 </p>

### To print key descriptor, name, message program (except PLU)

OPERATION	REPORT
<ol style="list-style-type: none"> <li>1. Turn to PGM mode.</li> <li>2. Enter &lt;2&gt; and press &lt;ST&gt; key.</li> <li>3. Press &lt;ST&gt; key.</li> </ol>	<p>                     P02..... Program read symbol                      GROSS 0001-01                      NET 0002-01                      CAID 0003-01 Fix total character                      0004-01                      CASH 0001-02 Transaction key character                      CHECK 0002-02                      0003-02                      0004-02                      DEPT001 0001-05 Department character                      DEPT002 0002-05                      0003-05                      0004-05                      GROUP01 0001-06 Group character                      GROUP02 0002-06                      0003-06                      0004-06                      C01 0001-07 Clerk character                      C02 0002-07                      0003-07                      GT 0001-20 GT character                      @No/ ** € 0001-23                      NoCT @LB *QT 0002-23                      X BUSY 0003-23 Special character                 </p> <p>                     FIX 0001-24 Report header character                      TRANS 0002-24                      0003-24                      0004-24                      DAILY X 0001-29 Batch X/Z character                      PERIODIC 1X 0002-29                      PERIODIC 2X 0003-29                      0004-29                      0001-32                      YOUR RECEIPT Receipt message                      0002-32                      THANK YOU                      0001-39                      CHARACTER RECALL***** Text recall character                      *****                      0002-39                      *****                      MC#01 0001-91                      0001-97                 </p>

## To print the machine program (except PLU)

### OPERATION

1. Turn to PGM mode.
2. Enter <3> and press <ST> key.
3. Press <ST> key.

### REPORT

P03.....		Program read symbol
CASH	0001-02	Transaction key program
	00000000000000	Key character/rec-#/file-#
CHECK	0002-02	Key program
	00000000000000	
PD	0003-02	Department program
	00000000000000	Key character/rec-#/file-#
DEPT001	0001-05	Key program
	00000000000000	Key character/rec-#/file-#
11-66	00000000	Address code 11 program
15-66	@1, 23	Address code 15 program
	0002-05	
C01	0001-07	Clerk program
	0001000001	Clerk name/rec-#/file-#
67	0000000000	Clerk #/secret-#
	0000000000	Compulsory
	00000000	Commission rate
	0002-07	
0001-09	00:00 -> 01:00	Time range program
0002-09	01:00 -> 02:00	
	02:00 -> 03:00	
0001-22	2200000000	General control program
0002-22	0000000000	
0003-22	0000000000	
0001-28		
0002-28		
0001-25		Tax table
TX1	10.25%	
TX1	0000	
TX1	5003	
DAILY X	0001-29	Batch X/Z program
00	11-12-17-15-00	
	00-00-00-00-00	
PERIODIC 1X	0002-29	
01	11-12-17-15-00	
	00-00-00-00-00	

0001-30		Clerk detail link program
NET	0001-01	
	0020-01	
0001-38	000001	Arrangement program
REG1	204-000	Rec-#/file-#/arrange no.
1	001-000	Key descriptor/rec-#/file-#
2	002-000	
DEPT001	026-051	
CASH	013-001	
0001-62	000000	Scheduler program
	00000000000000	
	0000000000	
MC#01	0001-91	
	00000000	
0001-98	00000000000000	I/O parameter table
0002-98	00000000000000	

# Advanced Operations and Setups

## To print the PLU unit price

### OPERATION

1. Turn to PGM mode.
2. Enter <6> and press <ST> key.
3. Enter <104> and press <ST> key.
4. Enter <start rec-#> and <CA> key.
5. Enter <end rec-#> and <CA> key.

### REPORT

P01.....		Program read symbol
#0001 - #0010		PLU range
PLU0001	0001-04	PLU descriptor/rec-#/04
	@1.00	Unit price
PLU0002	0002-04	
	@2.00	

## To print the PLU descriptor

### OPERATION

1. Turn to PGM mode.
2. Enter <6> and press <ST> key.
3. Enter <204> and press <ST> key.
4. Enter <start rec-#> and <CA> key.
5. Enter <end rec-#> and <CA> key.

### REPORT

P02.....		Program 2 mode symbol
#0001 - #0010		PLU range
PLU0001	0001-04	PLU character
PLU0002	0002-04	
PLU0003	0003-04	

## To print the PLU program

### OPERATION

1. Turn to PGM mode.
2. Enter <6> and press <ST> key.
3. Enter <304> and press <ST> key.
4. Enter <start rec-#> and <CA> key.
5. Enter <end rec-#> and <CA> key.

### REPORT

P03.....		Program 3 mode symbol
#0001 - #0010		PLU range
PLU0001	0001-04	PLU descriptor/rec-#/file-#
	00000000000000	Address code 01 ~ 10, 18 program
11-66	000000	Address code 11 program
13-66	<- 0001-28	Address code 13 program
14-66	0	
15-66	@1234.56	Address code 15 program
PLU0002	0002-04	



# Troubleshooting

This section describes what to do when you have problems with operation.

## When an error occurs

Errors are indicated by an error codes. When this happens, you can usually find out what the problem is as illustrated below.

Press **C** and check the appropriate section of this manual for the operation you want to perform.

Error code	Message	Meaning	Action
E001	Wrong mode	Mode switch position changed before finalization.	Return the mode switch to its original setting and finalize the operation.
E003	Wrong operator	The signed on clerk differs from the clerk performed the tracking check registration.	Input correct check number or assign the proper clerk number.
E004	Error INIT/FC	Initialization or unit lock clear operation in progress.	Complete operation.
E008	Please sign on	Registration without entering a clerk number.	Enter a clerk number.
E010	Close the drawer	The drawer is left open longer than the program time (drawer open alarm).	Close the drawer.
E011	Close the drawer	Attempt to register while the cash drawer is open.	Shut the cash drawer.
E016	Change back to REG mode	Two consecutive transactions attempted in the refund mode.	Switch to another mode and then back to the RF mode for the next transaction.
E017	Enter CHK/TBL number	Attempt made to register an item without inputting a check number.	Input a check number.
E018	Enter Table number	Attempt made to register an item without inputting a table number.	Input a table number.
E019	Enter number of customers	Finalize operation attempted without entering the number of customer.	Enter the number of customer.
E021	No DEPT Link	No department linked PLU is registered.	Correct the program.
E026	Enter condiment/preparation PLU	No condiment/preparation PLU is registered.	Register condiment/preparation PLU.
E029	In the tender operation	Item registration is prohibited, while partial tender.	Finalize the transaction.
E031	Press ST key	Finalization of a transaction attempted without confirming the subtotal.	Press <SUBTOTAL>.
E033	Enter tendered amount	Finalize operation attempted without entering amount tender.	Enter the amount tendered.
E035	Change amount exceeds limit	Change amount exceeds preset limit.	Input amount tendered again.
E036	Remove money from the drawer	Contents of the drawer exceed programmed limit.	Perform payout operation.
E037	Digit or amount limitation over	High amount lock out/low digit lock out error	Enter correct amount.
E038	Perform money declaration	Read/reset operation without declaring cash in drawer. This error appears only when this function is activated.	Perform money declaration.
E040	Issue guest receipt	Attempt to register a new transaction without issuing a guest receipt.	Issue a guest receipt.
E046	REG buffer full	Registration buffer full.	Finalize the transaction.
E049	CHECK memory full	Check tracking index memory full.	Finalize and close the check number currently used.
E050	DETAIL memory full	Check tracking detail memory full.	Finalize and close the check number currently used.
E051	CHK/TBL No. is occupied	Attempt to made use <New Check> to open a new check using a number that is already used for an existing check in check tracking memory.	Finalize and close the check that is currently under the number that you want to use or use a different check number.
E053	CHK/TBL No. is not opened	Attempt made to use <Old Check> reopen a new check using a number that is not used for an existing check in check tracking memory.	Use the correct check number (if you want to reopen a check that already exists in check tracking memory) or use <New Check> to open a new check.
E075	Negative balance cannot be finalized	Attempt to finalize a transaction when balance is less than or equal to zero.	Register item(s) until the balance becomes positive amount.

Error code	Message	Meaning	Action
E101	PLU maintenance file full. Press <#2> to exit	Scanning PLU direct maintenance/batch maintenance file becomes full.	Terminate the maintenance.
E103	PLU Code is not exist. Input the PLU Code	PLU code is not existed in the file.	Enter proper PLU code.
E105	PLU file full	Scanning PLU file full	Modify the designated item.
E106	Item exists in the PLU FILE	The designated item has already existed in the scanning PLU file.	
E112	Close the journal platen arm	The journal platen arm is opened.	Close the journal platen arm.
E114	Close the receipt platen arm	The receipt platen arm is opened.	Close the receipt platen arm.
E139	Negative balance is not allowed	Attempt to register <-> or <CPN> when the balance becomes negative.	Enter proper minus/coupon amount.
E146	Arrangement file full	Arrangement file is full.	Set the arrangement properly.
E200	Insert RAC	RAC is set.	Set RAC.
E201	Illegal Format	Illegally formatted RAC	Format the RAC.
E202	File not found	The designated file is not found in the RAC.	Enter proper file name.
E205	File already exist.	Can not write, because designated file has already been in the RAC.	Check the operation and retry.

## When the cash drawer does not open!

In case of power failure or the machine is in malfunction, the cash drawer does not open automatically. Even in these cases, you can open the cash drawer by pulling drawer release lever (see below).

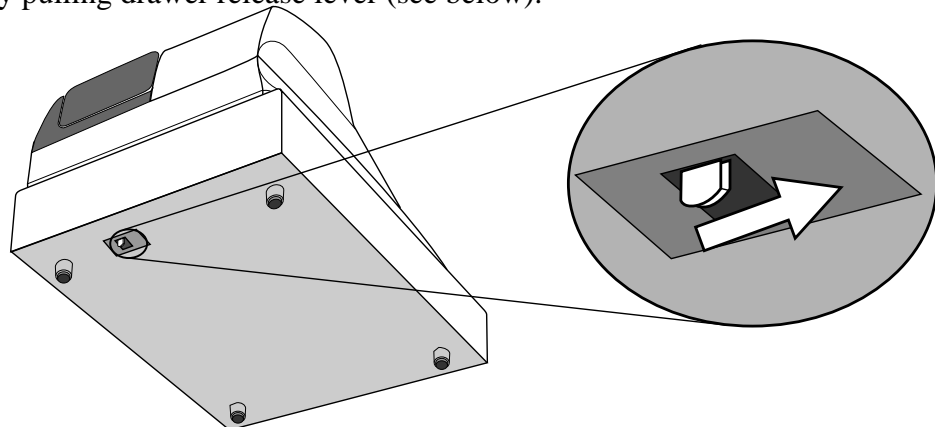

### Important!

The drawer will not open, if it is locked with a drawer lock key.

## When the register does not operate at all

Perform the following check whenever the cash register enter an error condition as soon as you switch it on. The results of this check are required by service personnel, so be sure to perform this check before you contact a CASIO representative for servicing.

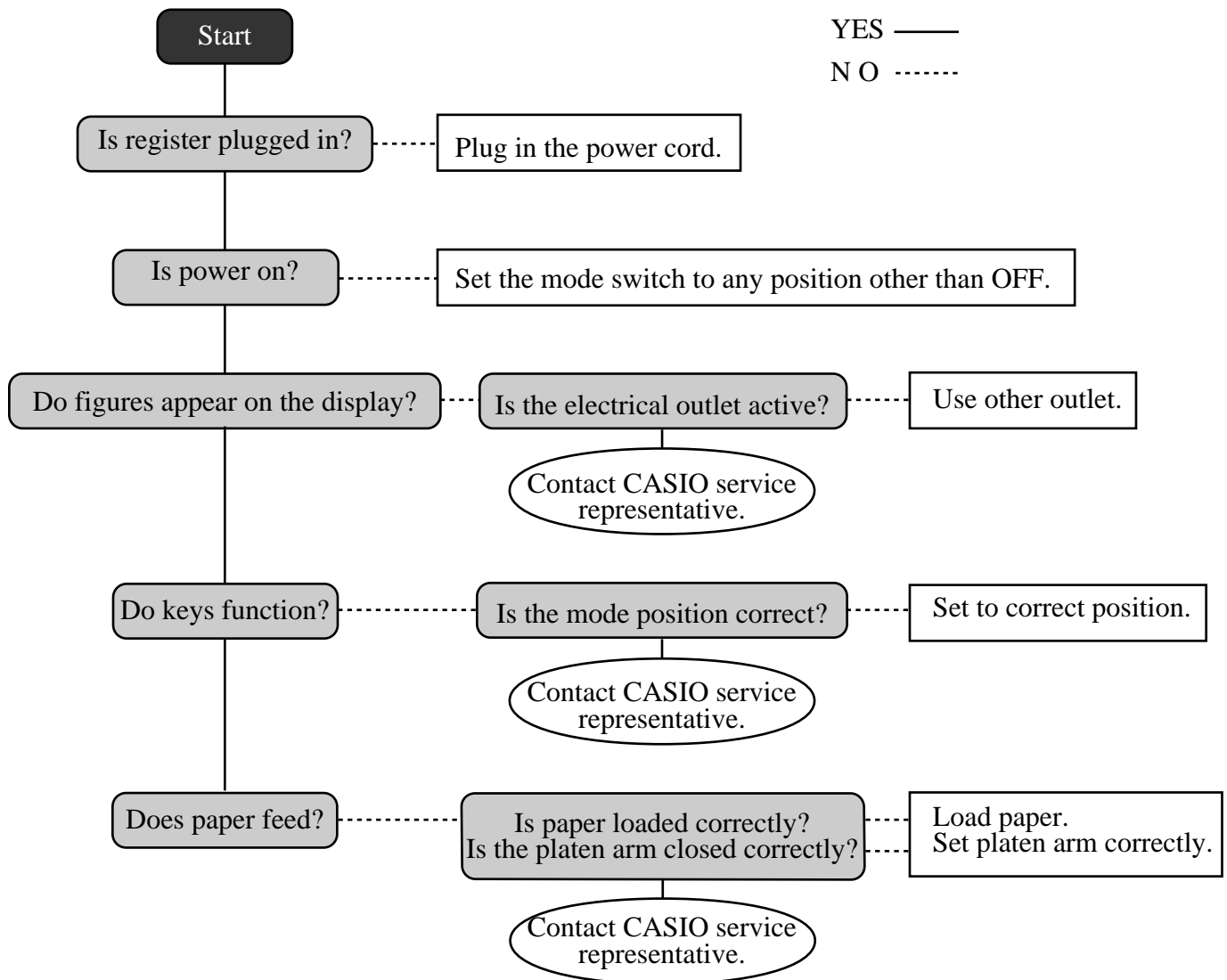

## Clearing a machine lock up

If you make a mistake in operation, the cash register may lock up to avoid damage to programs and preset data. Should it happens, you can use the following procedure to clear the lock up without losing any data.

- 1 Power off the register.
- 2 Insert the PGM key in the mode switch.
- 3 Press down **RECEIPT FEED**, and turn the mode switch to PGM mode.
- 4 The display shows 0.00, then release **RECEIPT FEED**.
- 5 Press **SUB TOTAL**, then issue a receipt.



## In case of power failure

If the power supply to the cash register is cut by a power failure or any other reason, simply wait for power to be restored. The details of any ongoing transaction as well as all sales data in memory are protected by the memory backup batteries. (This is the reason to install the batteries.)

- Power failure during a registration  
The subtotal for items registered up to the power failure is retained in memory. You will be able to continue with the registration when power is restored.
- Power failure during printing a read / reset report  
The data already printed before the power failure is retained in memory. You will be able to issue a report when power is restored.
- Power failure during printing of a receipt / journal  
Printing will resume after power is restored. A line that was being printed when the power failure occurred is printed in full.
- Other  
The power failure symbol is printed and any item that was being printed when the power failure occurred is reprinted in full.

### Important!

Once receipt / journal printing or printing of a report starts, it can be stopped only by interruption of power to the cash register.

## When the L sign appears on the display

### About the low battery indicator...

The following shows the low battery indicator.

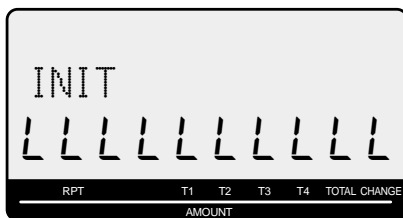

If this indicator appears when you switch the cash register on, it can mean one of three things:

- No memory backup batteries are loaded in the cash register.
- The power of the batteries loaded in the unit is below a certain level.
- The batteries loaded in the unit are dead.

### Important!

Whenever the low battery indicator appears on the display, load a set of two new batteries as soon as possible. If there is a power failure or you unplug the cash register when this indicator appears, you will lose all of your sales data and settings.

**BE SURE TO KEEP THE POWER CORD OF THE CASH REGISTER  
PLUGGED IN WHENEVER YOU REPLACE THE BATTERIES.**

## To replace journal paper



### Step 1

Set the mode switch to the REG position and remove the printer cover.

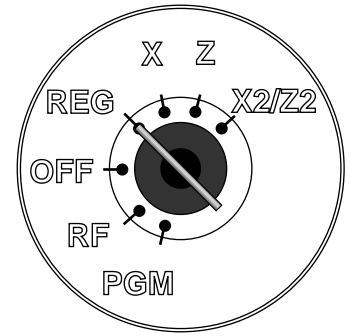

### Step 2

Press **JOURNAL FEED** to feed about 20 cm of paper.



### Step 6

Slide the printed journal from the take-up reel.



### Step 3

Cut the journal paper at the point where nothing is printed.



### Step 7

Open the platen arm.



### Step 4

Remove the journal take-up reel from its holder.



### Step 8

Remove the old paper roll from the cash register.



### Step 5

Remove the paper guide from the take-up reel.

### Step 9

Load new paper.

Go to the step 3 described on page 12 of this manual.

## To replace receipt paper



### Step 1

Set the mode switch to the REG position and remove the printer cover.



### Step 2

Open the platen arm.



### Step 3

Remove the old paper roll from the cash register.

### Step 4

Load new paper.

Go to the step 3 described on page 11 of this manual.

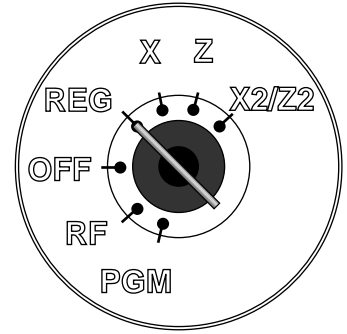

## Options

### P-5880T roll paper

### WT-89 wetproof cover

The optional wetproof cover protects the keyboard from moisture damage.

Consult your CASIO dealer for details.

# Specifications

## Input method

Entry: 10-key system, buffer memory 8 keys (2-key roll over)  
 Department: Full key system

## Display

Main: Amount 10 digits (zero suppression); No. of repeats, total, change, transaction indicator  
 Descriptor 16 digits × 2 lines; item descriptor, No. of items, mode, clerk name  
 Customer: Amount 8 digits (zero suppression)

## Printer

Receipt: Thermal alpha-numeric system 24 digits, receipt on/off key  
 Store name or slogan is printed automatically  
 Journal: Thermal alpha-numeric system 24 digits  
 Automatic take up roll winding  
 Paper roll: 58 (W) × 80 (D) mm  
 Paper thickness: 0.06 ~ 0.085 mm  
 Paper feed: Separate for receipt and journal  
 Print speed: About 14 l/s

## Listing capacity

Amount: 99999999  
 Quantity: 9999.999  
 Tendered amount: 9999999999  
 Percent: 99.99  
 Tax rate: 9999.9999  
 Numbers: 9999999999999999

## Chronological data

Date print: Automatic date printout on receipt or journal, automatic calendar  
 Time print: Automatic time printout on receipt or journal, 24-hour system/12-hour system

## Alarm

Key catch tone, error alarm, sentinel alarm

## Memory protection battery

The effective service life of memory protection batteries (two new size AA alkaline batteries) is approximately one year from installation into the machine.

## Power supply/power consumption

See the rating plate.

## Operation temperature

0°C ~ 40°C (32°F ~ 104°F)

## Humidity

10 ~ 90%

## Dimensions and weight

213mm (H) × 400mm (W) × 450mm (D) / 10kg ...with medium size drawer  
 (8.4" (H) × 15.7" (W) × 17.7" (D) / 22lbs.)

Category	No. of Totalizers	Contents				Periodic Totalizer
		Amount (10 digits)	No. of items (4 digits)	Count (4 digits)	No. of customers (4 digits)	
Department	200	✓ <sup>*1</sup>	✓ <sup>*3</sup>			✓
PLU	2000	✓ <sup>*1</sup>	✓ <sup>*3</sup>			
Hourly sales	24	✓ <sup>*1</sup>			✓ <sup>*4</sup>	
Monthly	31	✓ <sup>*1</sup>			✓ <sup>*4</sup>	
Clerk	50	✓ <sup>*1</sup>			✓ <sup>*4</sup>	
Transaction key & fix total	--	✓ <sup>*1</sup>	or ✓ <sup>*4</sup>	or ✓ <sup>*4</sup>	or ✓ <sup>*4</sup>	✓
Non resettable grand sales total	1	✓ <sup>*2</sup>				
Reset counter	8			✓ <sup>*4</sup>		✓
Consecutive No.	1			✓ <sup>*4</sup>		

\*1: -9,999,999.99 ~ 99,999,999.99 \*2: -999,999,999.99 ~ 9,999,999,999.99 \*3: -999.99 ~ 9999.99 \*4: 1 ~ 9999

\* Specifications and design are subject to change without notice.

## A

alphabet key 53, 54

## B

backlight 65

bottom message 26

## C

cancel 24, 44

CAPS key 53

cash 24, 69

cash in drawer 45

change 29

character enter key 53, 54

character keyboard 53

character manual input 53

charge 25, 38, 69

check 24, 38, 69

clear 24

clear key 53, 54

clerk 46

clerk function 64

clerk name 57

clerk number 24, 46, 72

commercial message 26

commission 66, 68, 73

compressed print 64

consecutive number 26, 60

correction 42, 43

credit 25, 38, 72

credit balance 61

currency exchange 25, 48, 63, 71

customer display 20, 22

## D

daily sales X 20

daily sales X report 74

daily sales Z 20

daily sales Z report 45, 74

daily X report 75

daily Z report 17, 76

date 28

date set 13

delete key 53, 54

department 25, 29, 56, 66, 67, 74

department number 25, 30

department report 45

department shift 25, 30

descriptor 52

descriptors by list 52

discount 24, 36, 70

display 22

double size letter key 53, 54

double Z report 63

drawer 20

drawer key 20

drawer lock 20

## E

error correct 24

## F

feed 24

fixed total report 45

flash report 78

function key 56

function key report 45

## G

general control program 60

grand total 45, 59

gross total 45

group report 79

## H

hash 66, 68

help 24

high amount limit 31, 68

high amount limitation 32

hourly report 78

## I

individual key report 74

item counter 26, 61

## J

journal 12, 26

journal skip 61

## K

key catch tone 61

key function program 66

keyboard 20

## L

link 68

logo message 26

low digit limitation 66, 68

## M

machine feature program 60

machine number 26, 60

magnetic plate 20

main display 20, 22

memory protection 10

merchandise subtotal 39, 70

message 57

message control 64

mixed tender 38

mode switch 20, 21

monthly report 78

multi tapping 54

multiplication 24, 30, 34

multiplication / for 24, 30, 35, 71

# Index

---

## N

negative price 66, 68  
net total 45  
no sale 41  
non-add / no sale 70  
non-add / no sale 25

## O

OFF mode 20  
open 25  
open PLU 35, 66, 68  
operator key 20

## P

paid out 24, 41, 69  
paper install 11  
periodic sale X/Z 20  
periodic sales X report 80  
periodic sales Z report 80  
PGM mode 20  
platen 11  
PLU 24, 33, 66, 67, 74  
PLU report 78  
pop-up display 20, 21  
post receipt 24  
premium 25, 50, 70  
preset graphic 26, 52, 64  
preset message 26, 52, 64  
preset price 32  
preset tax status 32  
price 24  
print control 61, 62, 63, 64  
printer 20  
printer cover 20  
program backup 16  
program end key 53, 54  
program key 20  
program mode 20  
program report 82

## R

rate 36  
receipt 11, 26  
receipt control 64  
receipt on/off 24  
received on account 24, 41, 69  
reduction 24, 37, 70  
refund 24, 40  
refund mode 20  
REG mode 20  
register mode 20  
repeat 23, 29, 34  
report 74  
report descriptor 58  
report sample 77  
report title 45, 59  
RF mode 20, 40

right cursor key 54  
roll paper 20

## S

shift key 53  
sign off 24, 46  
sign on 46  
single item 29, 34, 47, 66, 68  
space key 54  
special character 59  
stand-by 20  
status indicator 23  
subdepartment 24  
subtotal 24, 29, 70  
subtotal compulsory 61

## T

take-up reel 12, 20  
tax program 24  
tax shift 25, 39, 71  
tax status 31, 33, 36, 37  
tax system 60  
tax table 14  
taxable status 68  
thermal paper 11  
time 28  
time set 13  
training clerk 72

## U

unit price 29, 31, 33

## W

watermark 16

## X

X mode 20, 74  
X2/Z2 mode 20, 80

## Z

Z mode 20, 74  
zero skip 63  
zero unit price 66, 68

**LIMITED WARRANTY: ELECTRONIC CASH REGISTERS**

This product, except the battery, is warranted by Casio to the original purchaser to be free from defects in material and workmanship under normal use for a period, from the date of purchase, of one year for parts and 90 days for labor. For one year, upon proof of purchase, the product will be repaired or replaced (with the same or a similar model) at Casio's option, at a Casio Authorized Service Center without charge for parts. Labor will be provided without charge for 90 days. The terminal resident software and programmable software, if any, included with this product or any programmable software which may be licensed by Casio or one of its authorized dealers, is warranted by Casio to the original licensee for a period of ninety (90) days from the date of license to conform substantially to published specifications and documentation provided it is used with the Casio hardware and software for which it is designed.

For a period of ninety (90) days, upon proof of license, Casio will, at its option, replace defective terminal resident software or programmable software, correct significant program errors, or refund the license fee for such software. Significant program errors will be significant deviations from written documentation or specifications. These are your sole remedies for any breach of warranty. In no event will Casio's liability exceed the license fee, if any, for such software. This warranty will not apply if the product has been misused, abused, or altered.

Without limiting the foregoing, battery leakage, bending of the unit, a broken display tube, and any cracks or breaks in the display will be presumed to have resulted from misuse or abuse. To obtain warranty service you must take or ship the product, freight prepaid, with a copy of the sales receipt or other proof of purchase and the date of purchase, to a Casio Authorized Service Center. Due to the possibility of damage or loss, it is recommended when shipping the product to a Casio Authorized Service Center that you package the product securely and ship it insured. CASIO HEREBY EXPRESSLY DISCLAIMS ALL OTHER WARRANTIES, EXPRESS OR IMPLIED, INCLUDING ANY IMPLIED WARRANTY OF MERCHANTABILITY OR OF FITNESS FOR A PARTICULAR PURPOSE. NO RESPONSIBILITY IS ASSUMED FOR ANY INCIDENTAL OR CONSEQUENTIAL DAMAGES, INCLUDING WITHOUT LIMITATION DAMAGES RESULTING FROM MATHEMATICAL INACCURACY OF THE PRODUCT OR LOSS OF STORED DATA. SOME STATES DO NOT ALLOW THE EXCLUSION OR LIMITATION OF INCIDENTAL OR CONSEQUENTIAL DAMAGES, SO THE ABOVE LIMITATIONS OR EXCLUSIONS MAY NOT APPLY TO YOU. This warranty gives you specific rights, and you may also have other rights which vary from state to state.

**CASIO, INC.**  
570 MOUNT PLEASANT AVENUE,  
P. O. BOX 7000, DOVER, NEW JERSEY 07801 U.S.A.

Model:..... Serial Number:..... Date of Purchase:.....

Your Name:.....

Address:.....

Dealer's Name:.....

Address:.....

**CASIO®**

**CASIO COMPUTER CO., LTD.**  
6-2, Hon-machi 1-chome  
Shibuya-ku, Tokyo 151-8543, Japan

MO0712-A Printed in Indonesia

PCR-T2100\*E