



Все для звука в вашем автомобиле



Интернет-магазин

www.carsound.com.ua

FM/AM Compact Disc Player

Operating Instructions _____ GB

Manual de instrucciones _____ ES

To cancel the demonstration (DEMO) display, see page 6.
Para cancelar la pantalla de demostración (DEMO), consulte la página 6.

CDX-GT680UI
CDX-GT680UI



For installation and connections, see the supplied installation/connections manual.

CLASS 1 LASER PRODUCT

This label is located on the bottom of the chassis.



Microsoft, Windows Media, and the Windows logo are trademarks or registered trademarks of Microsoft

Corporation in the United States and/or other countries.

iPod is a trademark of Apple Inc., registered in the U.S. and other countries.

iPhone is a trademark of Apple Inc.

MPEG Layer-3 audio coding technology and patents licensed from Fraunhofer IIS and Thomson.

This product is protected by certain intellectual property rights of Microsoft Corporation. Use or distribution of such technology outside of this product is prohibited without a license from Microsoft or an authorized Microsoft subsidiary.

Content providers are using the digital rights management technology for Windows Media contained in this device ("WM-DRM") to protect the integrity of their content ("Secure Content") so that their intellectual property, including copyright, in such content is not misappropriated.

This device uses WM-DRM software to play Secure Content ("WM-DRM Software"). If the security of the WM-DRM Software in this device has been compromised, owners of Secure Content ("Secure Content Owners") may request that Microsoft revoke the WM-DRM Software's right to acquire new licenses to copy, display and/or play Secure Content. Revocation does not alter the WM-DRM Software's ability to play unprotected content. A list of revoked WM-DRM Software is sent to your device whenever you download a license for Secure Content from the Internet or from a PC. Microsoft may, in conjunction with such license, also download revocation lists onto your device on behalf of Secure Content Owners.

Warning if your car's ignition has no ACC position

Be sure to set the Auto Off function (page 16). The unit will shut off completely and automatically in the set time after the unit is turned off, which prevents battery drain.

If you do not set the Auto Off function, press and hold (OFF) until the display disappears each time you turn the ignition off.

Table of Contents

Getting Started

Playable discs on this unit	6
Resetting the unit	6
Canceling the DEMO mode	6
Preparing the card remote commander	6
Setting the clock	6
Detaching the front panel	7
Attaching the front panel	7

Location of controls and basic operations

Main unit	8
Card remote commander RM-X151	8
Searching for a track	10
Searching a track by name	
— Quick-BrowZer	10
Searching a track by listening to track passages	
— ZAPPIN	10

Radio

Storing and receiving stations	11
Storing automatically — BTM	11
Storing manually	11
Receiving the stored stations	11
Tuning automatically	11

CD

Playing a disc	12
Display items	12
Repeat and shuffle play	12

USB devices

Playing back a USB device	12
Display items	13
Repeat and shuffle play	13

iPod

Playing back iPod	14
Display items	15
Setting the play mode	15
Repeat and shuffle play	15
Operating an iPod directly	
— Passenger control	15

Other functions

Changing the sound settings	16
Adjusting the sound characteristics	16
Customizing the equalizer curve	
— EQ3	16
Adjusting setup items — SET	16
Using optional equipment	17
Auxiliary audio equipment	17
CD changer	18
Rotary commander RM-X4S	18

Additional Information

Precautions	19
Notes on discs	19
Playback order of MP3/WMA/AAC files	20
About iPod	20
Maintenance	20
Removing the unit	21
Specifications	21
Troubleshooting	22
Error displays/Messages	24

Support site

If you have any questions or for the latest support information on this product, please visit the web site below:

Customers in Latin America:

<http://esupport.sony.com/ES/LA/>

Customers in Pan Asia:

<http://www.sony-asia.com/section/support>

<http://www.sony-asia.com/caraudio/>







Provides information on:

- Models and manufacturers of compatible digital audio players
- Supported MP3/WMA/AAC files

Getting Started

Playable discs on this unit

This unit can play CD-DA (also containing CD TEXT) and CD-R/CD-RW (MP3/WMA/AAC files (page 19)).

Type of discs	Label on the disc	
CD-DA		
MP3 WMA AAC		
		

Resetting the unit

Before operating the unit for the first time, or after replacing the car battery or changing the connections, you must reset the unit.

Detach the front panel (page 7) and press the RESET button (page 8) with a pointed object, such as a ball-point pen.

Note

Pressing the RESET button will erase the clock setting and some stored contents.

Canceling the DEMO mode

You can cancel the demonstration display which appears during turning off.

1 Press and hold the select button.

The setup display appears.

2 Press the select button repeatedly until "DEMO" appears.

3 Rotate the control dial to select "DEMO-OFF."

4 Press and hold the select button.

The setup is complete and the display returns to normal play/reception mode.

Preparing the card remote commander

Remove the insulation film.

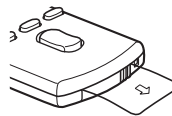

Tip

For how to replace the battery, page 20.

Setting the clock

The clock uses a 12-hour digital indication.

1 Press and hold the select button.

The setup display appears.

2 Press the select button repeatedly until "CLOCK-ADJ" appears.

3 Press (SEEK) +.

The hour indication flashes.

4 Rotate the control dial to set the hour and minute.

To move the digital indication, press (SEEK) +/-.

5 After setting the minute, press the select button.

The setup is complete and the clock starts.

To display the clock, press (DSPL). Press (DSPL) again to return to the previous display.

Detaching the front panel

You can detach the front panel of this unit to prevent theft.

Caution alarm

If you turn the ignition switch to the OFF position without detaching the front panel, the caution alarm will sound for a few seconds. The alarm will only sound if the built-in amplifier is used.

- 1 Press **OFF**.**
The unit is turned off.
- 2 Press **OPEN**.**
The front panel is flipped down.
- 3 Slide the front panel to the right, then gently pull out the left end of the front panel.**

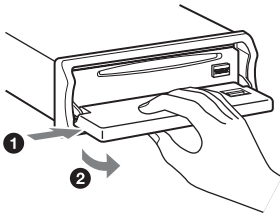

Notes

- Do not drop or put excessive pressure on the front panel and display window.
- Do not subject the front panel to heat/high temperature or moisture. Avoid leaving it in a parked car or on a dashboard/rear tray.
- Do not detach the front panel during playback of the USB device, otherwise USB data may be damaged.

Attaching the front panel

Place the hole **(A)** of the front panel onto the spindle **(B)** on the unit, then lightly push the left side in.

Press **SOURCE** on the unit (or insert a disc) to operate the unit.

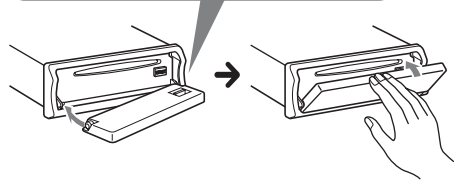
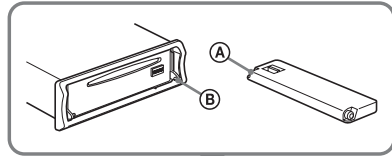

Note

Do not put anything on the inner surface of the front panel.

Location of controls and basic operations

Main unit

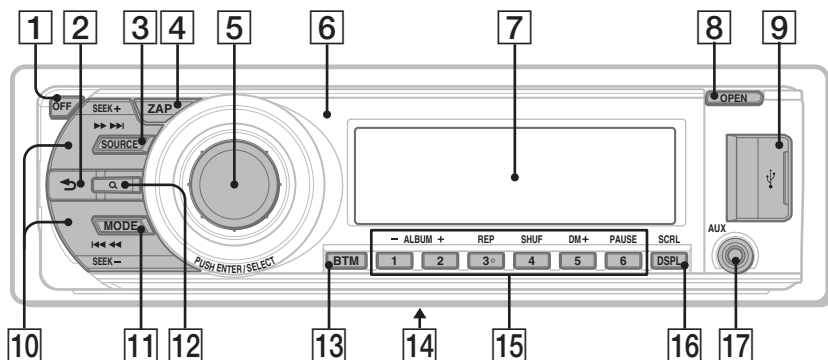

Front panel removed

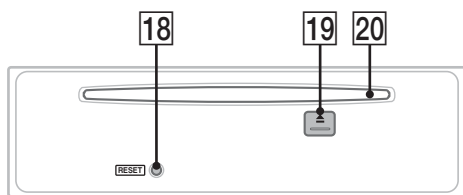

Card remote commander RM-X151

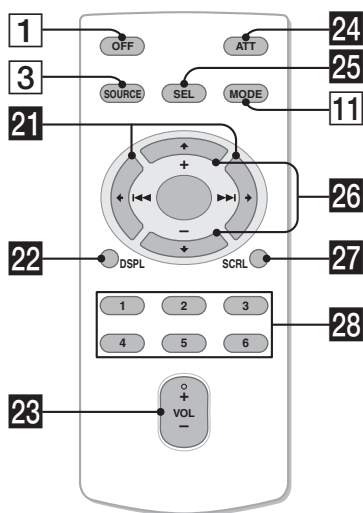

This section contains instructions on the location of controls and basic operations. For details, see the respective pages.

The corresponding buttons on the card remote commander control the same functions as those on the unit.

- 1 OFF button**
To power off; stop the source.
- 2 ↶ (BACK) button** page 10
To return to the previous display.
- 3 SOURCE button**
To power on; change the source (Radio/CD/USB/AUX)*.
- 4 ZAP button** page 11
To enter ZAPPIN mode.
- 5 Control dial/select button**
To adjust volume (rotate); select setup items (press and rotate).
- 6 Receptor for the card remote commander**
- 7 Display window**
- 8 OPEN button** page 7
- 9 USB terminal** page 12
To connect to the USB device.
- 10 SEEK +/- buttons**
CD/USB:
To skip tracks (press); skip tracks continuously (press, then press again within about 1 second and hold); reverse/fast-forward a track (press and hold).
Radio:
To tune in stations automatically (press); find a station manually (press and hold).

11 MODE button page 11, 14, 15
Press to: Select the radio band (FM/AM)/
select the play mode of iPod.
Press and hold to: Enter/cancel the passenger
control.

12 Q (BROWSE) button page 10
To enter the Quick-BrowZer mode.

13 BTM button page 11
To start the BTM function (press and hold).

14 Frequency select switch (located on the
bottom of the unit)
See “Frequency select switch” in the
supplied installation/connections manual.

15 Number buttons
CD/USB:
①/②: **ALBUM -/+** (during MP3/WMA/
AAC playback)

To skip albums (press); skip albums
continuously (press and hold).

③: **REP** page 12, 13, 15

④: **SHUF** page 12, 13, 15

⑤: **DM+**

Improves digitally compressed sound,
such as MP3.

To activate the DM+ function, set
“ON.” To cancel, set “OFF.”

⑥: **PAUSE**

To pause playback. To cancel, press
again.

Radio:

To receive stored stations (press); store
stations (press and hold).

16 DSPL (display)/SCRL (scroll) button
page 12, 13, 15
To change display items (press); scroll the
display item (press and hold).

17 AUX input jack page 17
To connect a portable audio device.

18 RESET button page 6

19 ▲ (eject) button
To eject the disc.

20 Disc slot
To insert the disc.

The following buttons on the card remote
commander have also different buttons/functions
from the unit. Remove the insulation film before
use (page 6).

21 ◀ (◀◀)/▶ (▶▶) buttons

To control CD/radio/USB, the same as
(SEEK) -/+ on the unit.

Setup, sound setting, etc., can be operated by
◀ ▶.

22 DSPL (display) button page 12, 13, 15
To change display items.

23 VOL (volume) +/- button
To adjust volume.

24 ATT (attenuate) button
To attenuate the sound. To cancel, press
again.

25 SEL (select) button
The same as the select button on the unit.

26 ↑ (+)/↓ (-) buttons
To control CD/USB, the same as ①/②
(ALBUM -/+) on the unit.
Setup, sound setting, etc., can be operated by
↑ ↓.

27 SCRL (scroll) button
To scroll the display item.

28 Number buttons
To receive stored stations (press); store
stations (press and hold).

** In the case of a CD changer being connected; when
(SOURCE) is pressed, “CD” and the unit number will
appear in the display. Furthermore, if (MODE) is
pressed, you can switch the changer.*

Note

*If the unit is turned off and the display disappears, it
cannot be operated with the card remote commander
unless (SOURCE) on the unit is pressed, or a disc is
inserted to activate the unit first.*

Searching for a track

Searching a track by name

— Quick-BrowZer

You can search for a track in a CD or USB device easily by category.

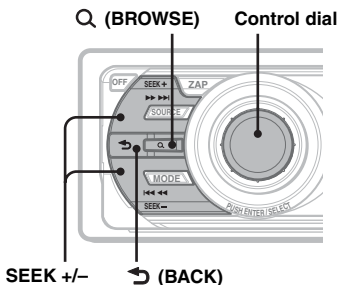

- 1 Press **Q (BROWSE)**.
The unit enters the Quick-BrowZer mode, and the list of search categories appears.
- 2 Rotate the control dial to select the desired search category, then press it to confirm.
- 3 Repeat step 2 until the desired track is selected.
Playback starts.

To return to the previous display

Press **(BACK)**.

To exit the Quick-BrowZer mode

Press **Q (BROWSE)**.

Note

When entering the Quick-BrowZer mode, the repeat/shuffle setting is canceled.

Searching by skip items

— Jump mode

When many items are in a category, you can search the desired item quickly.

- 1 Press **(SEEK) +** in Quick-BrowZer mode.
The following display appears.

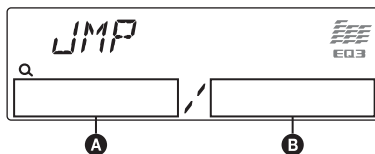

- A** Current item number
- B** Total item number in the current layer

Then the item name will appear.

- 2 Rotate the control dial to select the desired item, or one near the desired item.
It skips in steps of 10% of the total item number.
- 3 Press the control dial.
The display returns to the Quick-BrowZer mode and the selected item appears.
- 4 Rotate the control dial to select the desired item and press it.
Playback starts if the selected item is a track.

To cancel Jump mode

Press **(BACK)** or **(SEEK) -**.

Searching a track by listening to track passages — ZAPPIN

While playing back short track passages in a CD or USB device in sequence, you can search for a track you want to listen to.

ZAPPIN mode is suitable for searching for a track in shuffle or shuffle repeat mode.

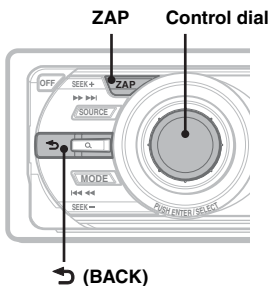

1 Press **ZAP** during playback.

After “ZAPPIN” appears in the display, playback starts from a passage of the next track.

The passage is played for the set time, then a click sounds and the next passage starts.

Track

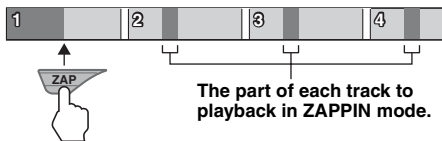

2 Press the control dial or **ZAP** when a track you want to listen is played back.

The track that you select returns to normal play mode from the beginning.

To search a track by ZAPPIN mode again, repeat steps 1 and 2.

Tips

- You can select the playback time from about 6 seconds/9 seconds/30 seconds (page 17). You cannot select the passage of the track to playback.
- Press **SEEK** $-/+$ or **1/2** (**ALBUM** $-/+$) in ZAPPIN mode to skip a track or album.
- Pressing **BACK** also confirms a track to playback.

Radio

Storing and receiving stations

Caution

When tuning in stations while driving, use Best Tuning Memory (BTM) to prevent an accident.

Storing automatically — BTM

1 Press **SOURCE** repeatedly until “TUNER” appears.

To change the band, press **MODE** repeatedly. You can select from FM1, FM2, FM3, AM1 or AM2.

2 Press and hold **BTM** until “BTM” flashes.

The unit stores stations in order of frequency on the number buttons.

A beep sounds when the setting is stored.

Storing manually

1 While receiving the station that you want to store, press and hold a number button (**1** to **6**) until “MEM” appears.

Note

If you try to store another station on the same number button, the previously stored station will be replaced.

Receiving the stored stations

1 Select the band, then press a number button (**1** to **6**).

Tuning automatically

1 Select the band, then press **SEEK** $+/-$ to search for the station.

Scanning stops when the unit receives a station. Repeat this procedure until the desired station is received.

Tip

If you know the frequency of the station you want to listen to, press and hold **SEEK** $+/-$ to locate the approximate frequency, then press **SEEK** $+/-$ repeatedly to fine adjust to the desired frequency (manual tuning).

CD

Playing a disc

- 1 Press **(OPEN)**.
- 2 Insert the disc (label side up).
- 3 Close the front panel.
Playback starts automatically.

Ejecting the disc

- 1 Press **(OPEN)**.
- 2 Press **▲**.
The disc is ejected.
- 3 Close the front panel.

Display items

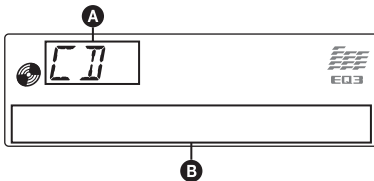

- A** Source
B Track name*¹, Disc/artist name*¹, Artist name*¹, Album number*², Album name*¹, Track number/Elapsed playing time, Clock

*¹ The information of a CD TEXT, MP3/WMA/AAC is displayed.

*² Album number is displayed only when the album is changed.

To change display items **B**, press **(DSPL)**.

Tip

Displayed items will differ depending on the disc type, recording format and settings.

Repeat and shuffle play

- 1 During playback, press **(3)** (REP) or **(4)** (SHUF) repeatedly until the desired setting appears.

Select	To play
↶ TRACK	track repeatedly.
↶ ALBUM*	album repeatedly.
SHUF ALBUM*	album in random order.
SHUF DISC	disc in random order.

* When an MP3/WMA/AAC is played.

To return to normal play mode, select “**↶ OFF**” or “**SHUF OFF**.”

USB devices

For details on the compatibility of your USB device, visit the support site.

Support site

Customers in Latin America:

<http://esupport.sony.com/ES/LA/>

Customers in Pan Asia:

<http://www.sony-asia.com/section/support>

<http://www.sony-asia.com/caraudio/>

- MSC (Mass Storage Class) and MTP (Media Transfer Protocol) type USB devices compliant with the USB standard can be used.
- Corresponding codec is MP3 (.mp3), WMA (.wma) and AAC (.m4a).
- Backup of data in a USB device is recommended.

Note

Connect the USB device after starting the engine. Depending on the USB device, malfunction or damage may occur if it is connected before starting the engine.

Playing back a USB device

- 1 Slide the USB cover.

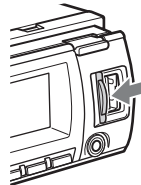

- 2 Connect the USB device to the USB terminal.

When using a cable, use the one supplied with the USB device to connect.

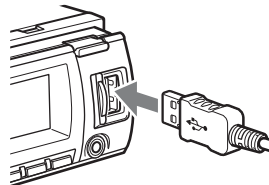

Playback starts.

If a USB device is already connected, to start playback, press **(SOURCE)** repeatedly until “USB” appears.

Press **(OFF)** to stop playback.

Removing the USB device

- 1 Stop the USB device playback.
- 2 Remove the USB device.
If you remove your USB device during playback, data in the USB device may be damaged.

Notes

- Do not use USB devices so large or heavy that they may fall down due to vibration, or cause a loose connection.
- Do not detach the front panel during playback of the USB device, otherwise USB data may be damaged.
- This unit cannot recognize USB devices via a USB hub.

Display items

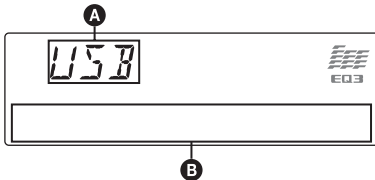

- A** Source
- B** Track name, Artist name, Album number*, Album name, Track number/Elapsed playing time, Clock

* Album number is displayed only when the album is changed.

To change display items **B**, press (DSPL).

Notes

- Displayed items will differ, depending on the USB device, recorded format and settings. For details, visit the support site.
- The maximum number of displayable data is as follows.
 - folders (albums): 128
 - files (tracks) per folder: 500
- Do not leave a USB device in a parked car, as malfunction may result.
- It may take time for playback to begin, depending on the amount of recorded data.
- DRM (Digital Rights Management) files may not be played.
- During playback or fast-forward/reverse of a VBR (Variable Bit Rate) MP3/WMA/AAC file, elapsed playing time may not display accurately.
- Playback of the following MP3/WMA/AAC files is not supported.
 - lossless compression
 - copyright-protected

Repeat and shuffle play

- 1 During playback, press (3) (REP) or (4) (SHUF) repeatedly until the desired setting appears.

Select	To play
↶ TRACK	track repeatedly.
↶ ALBUM	album repeatedly.
SHUF ALBUM	album in random order.
SHUF DEVICE	device in random order.

After 3 seconds, the setting is complete.

To return to normal play mode, select “↶ OFF” or “SHUF OFF.”

iPod

For details on the compatibility of your iPod, see “About iPod” on page 20 or visit the support site.

In these Operating Instructions, “iPod” is used as a general reference for the iPod functions on the iPod and iPhone, unless otherwise specified by the text or illustrations.

Support site

Customers in Latin America:

<http://esupport.sony.com/ES/LA/>

Customers in Pan Asia:

<http://www.sony-asia.com/section/support>

<http://www.sony-asia.com/caraudio/>

Playing back iPod

Before connecting the iPod, turn down the volume of the unit.

1 Slide the USB cover.

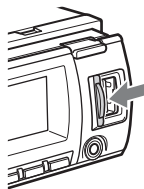

2 Connect the iPod to the USB terminal via the dock connector to USB cable.

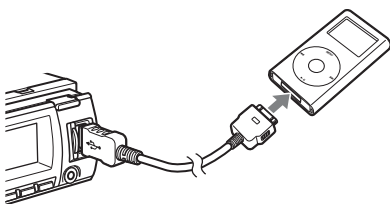

The iPod will turn on automatically, and the display will appear on the iPod screen as below.*



Tip

We recommend the RC-100IP USB cable (not supplied) to connect the dock connector.

The tracks on the iPod start playing automatically from the point last played.

If an iPod is already connected, to start playback press **(SOURCE)** repeatedly until “USB” appears. (“IPD” appears in the display when iPod is recognized.)

* If the iPod was played back in the passenger control last time, this will not appear.

3 Press **(MODE)** to select the play mode.

The mode changes as follows:

RESUMING → **ALBUM** → **TRACK** →
PODCAST* → **GENRE** → **PLAYLIST**
→ **ARTIST**

* May not appear depending on iPod setting.

4 Adjust the volume.

Press **(OFF)** to stop playback.

Removing the iPod

1 Stop the iPod playback.

2 Remove the iPod.

Caution for iPhone

When you connect an iPhone via USB, telephone volume is controlled by iPhone itself. In order to avoid sudden loud sound after a call, do not increase the volume on the unit during a telephone call.

Notes

- Do not detach the front panel during playback of the iPod, otherwise data may be damaged.
- This unit cannot recognize iPod via a USB hub.

Tips

- When the ignition key is turned to the ACC position, and the unit is on, the iPod will be recharged.
- If the iPod is disconnected during playback, “NO DEV” appears in the display of the unit.

Resume mode

When the iPod is connected to the dock connector, the mode of this unit changes to resume mode and playback starts in the mode set by the iPod.

In resume mode, the following buttons do not function.

- **(3)** (REP)
- **(4)** (SHUF)

Display items

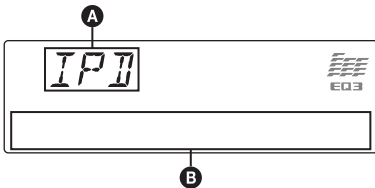

- A** Source (iPod) indication
B Track name, Artist name, Album name, Track number/Elapsed playing time, Clock

To change display items **B**, press (DSPL).

Tip

When album/podcast/genre/artist/playlist is changed, its item number appears momentarily.

Note

Some letters stored in iPod may not be displayed correctly.

Setting the play mode

- 1** During playback, press (MODE).

The mode changes as follows:

ALBUM → **TRACK** → **PODCAST*** →
GENRE → **PLAYLIST** → **ARTIST**

* May not appear depending on iPod setting.

Skipping albums, podcasts, genres, playlists and artists

To	Press
Skip	(1)/(2) (ALBUM -/+) [press once for each]
Skip continuously	(1)/(2) (ALBUM -/+) [hold to desired point]

Repeat and shuffle play

- 1** During playback, press (3) (REP) or (4) (SHUF) repeatedly until the desired setting appears.

Select	To play
↶ TRACK	track repeatedly.
↶ ALBUM	album repeatedly.
↶ PODCAST	podcast repeatedly.
↶ ARTIST	artist repeatedly.
↶ PLAYLIST	playlist repeatedly.
↶ GENRE	genre repeatedly.
SHUF ALBUM	album in random order.
SHUF PODCAST	podcast in random order.
SHUF ARTIST	artist in random order.
SHUF PLAYLIST	playlist in random order.
SHUF GENRE	genre in random order.
SHUF DEVICE	device in random order.

After 3 seconds, the setting is complete.

To return to normal play mode, select “↶ OFF” or “SHUF OFF.”

Operating an iPod directly — Passenger control

You can operate an iPod connected to the dock connector directly.

- 1** During playback, press and hold (MODE).

“MODE IPOD” appears and you will be able to operate the iPod directly.

To change the display items

Press (DSPL).

The display items change as follows:

Track name → Artist name → Album name →
MODE IPOD → Clock

To exit the passenger control

Press and hold (MODE).

Then “MODE AUDIO” will appear and the play mode will change to “RESUMING.”

Notes

- The volume can be adjusted only by the unit.
- If this mode is canceled, the repeat setting will be turned off.

Other functions

Changing the sound settings

Adjusting the sound characteristics

- 1 Press the select button repeatedly until the desired item appears.
- 2 Rotate the control dial to adjust the selected item.
- 3 Press **↶** (BACK).
The setting is complete and the display returns to normal play/reception mode.

The following items can be set (follow the page reference for details):

EQ3

Selects an equalizer curve from 7 music types.

DSO (Dynamic Soundstage Organizer)

Creates a more ambient sound field.

To select the DSO mode: "1," "2," "3" or "OFF."
The larger the number, the more enhanced the effect.

LOW*1, MID*1, HI*1 (page 16)

BAL (Balance)

Adjusts the sound balance between the left and right speakers.

FAD (Fader)

Adjusts the relative level between the front and rear speakers.

SUB (Subwoofer volume)

Adjusts the subwoofer volume.

AUX (AUX level)*2

Adjusts the volume level for each connected auxiliary equipment: "+18 dB" – "0 dB" – "-8 dB."

This setting negates the need to adjust the volume level between sources.

*1 When EQ3 is activated.

*2 When AUX source is activated.

Customizing the equalizer curve — EQ3

"CUSTOM" of EQ3 allows you to make your own equalizer settings.

- 1 Select a source, then press the select button repeatedly to select "EQ3."
- 2 Rotate the control dial to select "CUSTOM."

- 3 Press the select button repeatedly until "LOW," "MID" or "HI" appears.

- 4 Rotate the control dial to adjust the selected item.

The volume level is adjustable in 1 dB steps, from -10 dB to +10 dB.



Repeat steps 3 and 4 to adjust the equalizer curve.

To restore the factory-set equalizer curve, press and hold the select button before the setting is complete.

- 5 Press **↶** (BACK).

The setting is complete and the display returns to normal play/reception mode.

Tip

Other equalizer types are also adjustable.

Adjusting setup items — SET

- 1 Press and hold the select button.

The setup display appears.

- 2 Press the select button repeatedly until the desired item appears.

- 3 Rotate the control dial to select the setting (example "ON" or "OFF").

- 4 Press and hold the select button.

The setup is complete and the display returns to normal play/reception mode.

Note

Displayed items will differ, depending on the source and setting.

The following items can be set (follow the page reference for details):

CLOCK-ADJ (Clock Adjust) (page 6)

BEEP

Activates the beep sound: "ON," "OFF."

AUX-A*1 (AUX Audio)

Activates the AUX source display: "ON," "OFF" (page 17).

AUTO OFF

Shuts off automatically after a desired time when the unit is turned off: "NO," "30S (seconds)," "30M (minutes)," "60M (minutes)."

B.OUT (Black Out)

Turns off the illumination automatically for any source (e.g., during CD playback/radio reception, etc) if no operation is performed for 5 seconds: "ON," "OFF."

To bring the light back on, press any button on the unit. (When activated, remote operation is unavailable.)

DEMO (Demonstration)

Activates the demonstration: "ON," "OFF."

DIMMER

Changes the display brightness.

– "AT": to dim the display automatically when you turn lights on. (Available only when the illumination control lead is connected.)

– "ON": to dim the display.

– "OFF": deactivate the dimmer.

CONTRAST

Adjusts the contrast of the display. The contrast level is adjustable in 7 steps.

ILLUMI (Illumination)

Changes the illumination color: "ILLUMI-1," "ILLUMI-2."

M.DSPL (Motion Display)

Selects the Motion Display mode.

– "SA": to show moving patterns and spectrum analyzer.

– "ON": to show moving patterns.

– "OFF": to deactivate the Motion Display.

A.SCRL (Auto Scroll)

Scrolls long items automatically: "ON," "OFF."

LOCAL (Local Seek Mode)

– "ON": to only tune into stations with stronger signals.

– "OFF": to tune normal reception.

MONO*2 (Monaural Mode)

Selects monaural reception mode to improve poor FM reception: "ON," "OFF."

ZAP.TIME (Zappin Time)

Selects the playback time for the ZAPPIN function.

– "ZAP.TIME-1 (6 seconds)," "ZAP.TIME-2 (9 seconds)," "ZAP.TIME-3 (30 seconds)."

LPF (Low Pass Filter)

Selects the subwoofer cut-off frequency: "OFF," "80Hz," "100Hz," "120Hz," "140Hz," "160Hz."

LPF NORM/REV (Low Pass Filter Normal/

Reverse)

Selects the phase when the LPF is on: "NORM," "REV."

HPF (High Pass Filter)

Selects the front/rear speaker cut-off frequency: "OFF," "80Hz," "100Hz," "120Hz," "140Hz," "160Hz."

LOUD (Loudness)

Reinforces bass and treble for clear sound at low volume levels: "ON," "OFF."

BTM (page 11)

*1 When the unit is turned off.

*2 When FM is received.

Using optional equipment

Auxiliary audio equipment

By connecting an optional portable audio device to the AUX input jack (stereo mini jack) on the unit and then simply selecting the source, you can listen on your car speakers. The volume level is adjustable for any difference between the unit and the portable audio device. Follow the procedure below:

Connecting the portable audio device

- 1 Turn off the portable audio device.
- 2 Turn down the volume on the unit.
- 3 Connect to the unit.

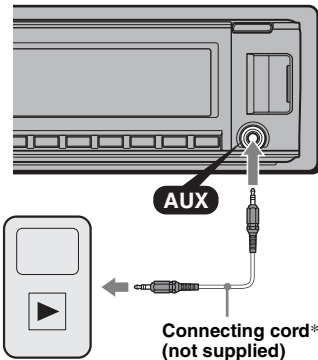

* Be sure to use a straight type plug.

Adjust the volume level

Be sure to adjust the volume for each connected audio device before playback.

- 1 Turn down the volume on the unit.
- 2 Press **(SOURCE)** repeatedly until "AUX" appears.
"AUX FRONT IN" appears.

continue to next page →

- 3 Start playback of the portable audio device at a moderate volume.
- 4 Set your usual listening volume on the unit.
- 5 Adjust the input level (page 16).

CD changer

Selecting the changer

- 1 Press **(SOURCE)** repeatedly until “CD” appears.
- 2 Press **(MODE)** repeatedly until the desired changer appears.

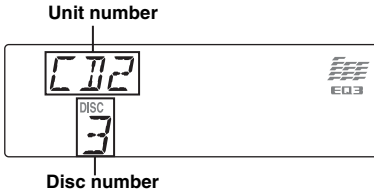

Playback starts.

Skipping albums and discs

- 1 During playback, press **(1)/(2)** (ALBUM -/+).

To skip	Press (1)/(2) (ALBUM -/+)
album	and release (hold for a moment).
album continuously	within 2 seconds of first releasing.
discs	repeatedly.
discs continuously	then, press again within 2 seconds and hold.

Repeat and shuffle play

- 1 During playback, press **(3)** (REP) or **(4)** (SHUF) repeatedly until the desired setting appears.

Select	To play
DISC	disc repeatedly.
SHUF CHANGER	tracks in the changer in random order.

To return to normal play mode, select “**OFF**” or “**SHUF OFF**.”

Rotary commander RM-X4S

Attaching the label

Attach the indication label depending on how you mount the rotary commander.

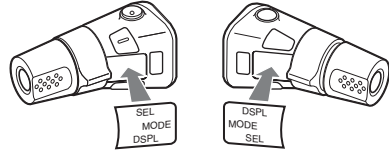

Location of controls

The corresponding buttons on the rotary commander control the same functions as those on this unit.

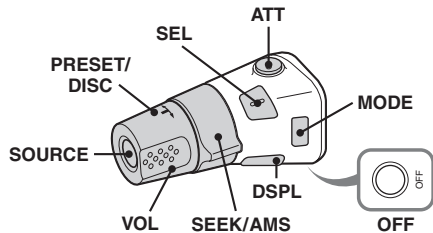

The following controls on the rotary commander require a different operation from the unit.

- **ATT (attenuate) button**
To attenuate the sound. To cancel, press again.
- **PRESET/DISC control**
CD/USB: The same as **(1)/(2)** (ALBUM -/+) on the unit (push in and rotate).
Radio: To receive stored stations (push in and rotate).
- **VOL (volume) control**
The same as the control dial on the unit (rotate).
- **SEEK/AMS control**
The same as **(SEEK) +/-** on the unit (rotate, or rotate and hold).
- **DSPL (display) button**
To change display items.

Changing the operative direction

The operative direction of the controls is factory-set as shown below.



If you need to mount the rotary commander on the right hand side of the steering column, you can reverse the operative direction.

- 1 While pushing the VOL control, press and hold (SEL).

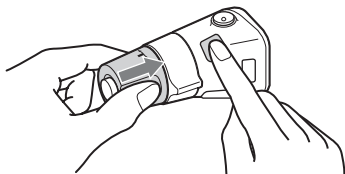

Additional Information

Precautions

- Cool off the unit beforehand if your car has been parked in direct sunlight.
- Power antenna (aerial) extends automatically.

Moisture condensation

Should moisture condensation occur inside the unit, remove the disc and wait for about an hour for it to dry out; otherwise the unit will not operate properly.

To maintain high sound quality

Do not splash liquid onto the unit or discs.

Notes on discs

- Do not expose discs to direct sunlight or heat sources such as hot air ducts, nor leave it in a car parked in direct sunlight.
- Before playing, wipe the discs with a cleaning cloth from the center out. Do not use solvents such as benzine, thinner, commercially available cleaners.
- This unit is designed to playback discs that conform to the Compact Disc (CD) standard. DualDiscs and some of the music discs encoded with copyright protection technologies do not conform to the Compact Disc (CD) standard, therefore, these discs may not be playable by this unit.
- **Discs that this unit CANNOT play**
 - Discs with labels, stickers, or sticky tape or paper attached. Doing so may cause a malfunction, or may ruin the disc.
 - Discs with non-standard shapes (e.g., heart, square, star). Attempting to do so may damage the unit.
 - 8 cm (3 1/4 in) discs.



Notes on CD-R/CD-RW discs

- The maximum number of: (CD-R/CD-RW only)
 - folders (albums): 150 (including root folder)
 - files (tracks) and folders: 300 (may less than 300 if folder/file names contain many characters)
 - displayable characters for a folder/file name: 32 (Joliet)/64 (Romeo)
- If the multi-session disc begins with a CD-DA session, it is recognized as a CD-DA disc, and other sessions are not played back.

continue to next page →

- **Discs that this unit CANNOT play**
 - CD-R/CD-RW of poor recording quality.
 - CD-R/CD-RW recorded with an incompatible recording device.
 - CD-R/CD-RW which is finalized incorrectly.
 - CD-R/CD-RW other than those recorded in music CD format or MP3 format conforming to ISO9660 Level 1/Level 2, Joliet/Romeo or multi-session.

Playback order of MP3/WMA/AAC files

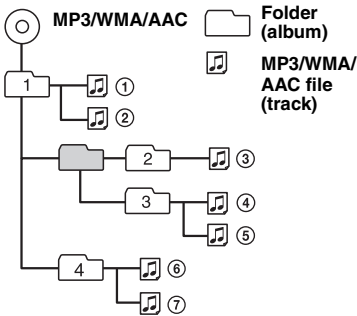

About iPod

This unit can be connected to the following iPods. Update your iPod to the latest software before you use it.

- iPod nano 1st generation*
- iPod nano 2nd generation (aluminum)
- iPod nano 3rd generation (video)
- iPod 5th generation (video)*
- iPod classic
- iPod touch
- iPhone and iPhone 3G

* When you connect iPod nano 1st generation or iPod 5th generation, Passenger control is not available.

If you have any questions or problems concerning your unit that are not covered in this manual, consult your nearest Sony dealer.

Maintenance

Replacing the lithium battery of the card remote commander

Under normal conditions, the battery will last approximately 1 year. (The service life may be shorter, depending on the conditions of use.)

When the battery becomes weak, the range of the card remote commander becomes shorter. Replace the battery with a new CR2025 lithium battery. Use of any other battery may present a risk of fire or explosion.

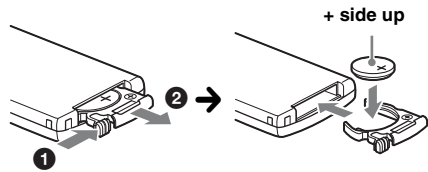

Notes on the lithium battery

- Keep the lithium battery out of the reach of children. Should the battery be swallowed, immediately consult a doctor.
- Wipe the battery with a dry cloth to assure a good contact.
- Be sure to observe the correct polarity when installing the battery.
- Do not hold the battery with metallic tweezers, otherwise a short-circuit may occur.

WARNING

Battery may explode if mistreated. Do not recharge, disassemble, or dispose of in fire.

Fuse replacement

When replacing the fuse, be sure to use one matching the amperage rating stated on the original fuse. If the fuse blows, check the power connection and replace the fuse. If the fuse blows again after replacement, there may be an internal malfunction. In such a case, consult your nearest Sony dealer.

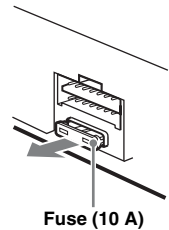

Cleaning the connectors

The unit may not function properly if the connectors between the unit and the front panel are not clean. In order to prevent this, detach the front panel (page 7) and clean the connectors with a cotton swab. Do not apply too much force. Otherwise, the connectors may be damaged.

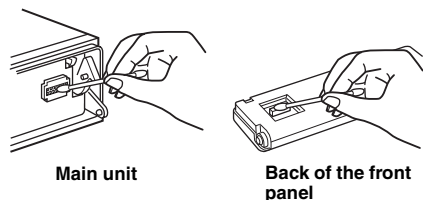

Notes

- For safety, turn off the ignition before cleaning the connectors, and remove the key from the ignition switch.
- Never touch the connectors directly with your fingers or with any metal device.

Removing the unit

1 Remove the protection collar.

- ① Detach the front panel (page 7).
- ② Pinch both edges of the protection collar, then pull it out.

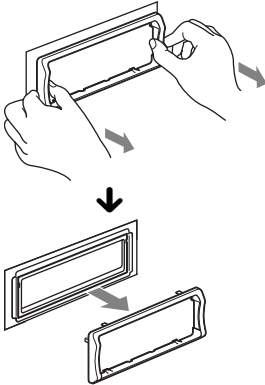

2 Remove the unit.

- ① Insert both release keys simultaneously until they click.

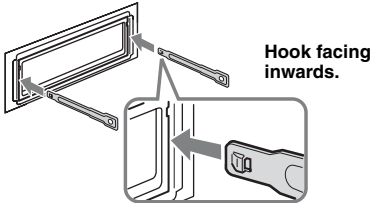

- ② Pull the release keys to unseat the unit.

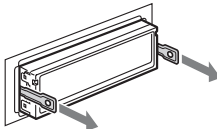

- ③ Slide the unit out of the mounting.

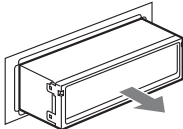

Specifications

CD Player section

Signal-to-noise ratio: 120 dB
Frequency response: 10 – 20,000 Hz
Wow and flutter: Below measurable limit

Tuner section

FM

Tuning range:

87.5 – 108.0 MHz (at 50 kHz step)
87.5 – 107.9 MHz (at 200 kHz step)

FM tuning interval: 50 kHz/200 kHz switchable

Antenna (aerial) terminal:

External antenna (aerial) connector

Intermediate frequency: 150 kHz

Usable sensitivity: 10 dBf

Selectivity: 75 dB at 400 kHz

Signal-to-noise ratio: 70 dB (mono)

Separation: 40 dB at 1 kHz

Frequency response: 20 – 15,000 Hz

AM

Tuning range:

531 – 1,602 kHz (at 9 kHz step)

530 – 1,710 kHz (at 10 kHz step)

AM tuning interval: 9 kHz/10 kHz switchable

Antenna (aerial) terminal:

External antenna (aerial) connector

Intermediate frequency: 25 kHz

Sensitivity: 26 μ V

USB Player section

Interface: USB (Full-speed)

Maximum current: 500mA

Power amplifier section

Output: Speaker outputs (sure seal connectors)

Speaker impedance: 4 – 8 ohms

Maximum power output: 52 W \times 4 (at 4 ohms)

General

Outputs:

Audio outputs terminal (front/rear)

Subwoofer output terminal (mono)

Power antenna (aerial) relay control terminal

Power amplifier control terminal

Inputs:

Remote controller input terminal

Antenna (aerial) input terminal

Telephone ATT control terminal

Illumination control terminal

BUS control input terminal

BUS audio input terminal

AUX input jack (stereo mini jack)

USB signal input terminal

Tone controls:

Low: \pm 10 dB at 60 Hz (XPLOD)

Mid: \pm 10 dB at 1 kHz (XPLOD)

High: \pm 10 dB at 10 kHz (XPLOD)

Power requirements: 12 V DC car battery
(negative ground (earth))

continue to next page →

Dimensions: Approx. 178 × 50 × 182 mm
(7 ¹/₈ × 2 × 7 ¹/₄ in) (w/h/d)

Mounting dimensions: Approx. 182 × 53 × 162 mm
(7 ¹/₄ × 2 ¹/₈ × 6 ¹/₂ in) (w/h/d)

Mass: Approx. 1.3 kg (2 lb 14 oz)

Supplied accessories:

- Card remote commander: RM-X151
- Parts for installation and connections (1 set)

Optional accessory:

- Rotary commander: RM-X4S
- CD changer (10 discs): CDX-757MX, CDX-656X
- AUX-IN selector: XA-300
- USB connection cable for iPod: RC-100IP

Your dealer may not handle some of the above listed accessories. Please ask the dealer for detailed information.

Design and specifications are subject to change without notice.



- Halogenated flame retardants are not used in the certain printed wiring boards.
- Halogenated flame retardants are not used in cabinets.
- Packaging cushions are made from paper.

Troubleshooting

The following checklist will help you remedy problems you may encounter with your unit. Before going through the checklist below, check the connection and operating procedures.

If the problem is not solved, visit the following support site.

Support site

Customers in Latin America:

<http://esupport.sony.com/ES/LA/>

Customers in Pan Asia:

<http://www.sony-asia.com/section/support>
<http://www.sony-asia.com/caraudio/>

General

No power is being supplied to the unit.

- Check the connection or fuse.
- If the unit is turned off and the display disappears, it cannot be operated with the remote commander.
→ Turn on the unit.

The power antenna (aerial) does not extend.

The power antenna (aerial) does not have a relay box.

No sound.

- The ATT function is activated, or the Telephone ATT function (when the interface cable of a car telephone is connected to the ATT lead) is activated.
- The position of the fader control "FAD" is not set for a 2-speaker system.

No beep sound.

- The beep sound is canceled (page 16).
- An optional power amplifier is connected and you are not using the built-in amplifier.

The contents of the memory have been erased.

- The RESET button has been pressed.
→ Store again into the memory.
- The power supply lead or battery has been disconnected or it is not connected properly.

Stored stations and correct time are erased.

The fuse has blown.

Makes noise when the position of the ignition is switched.

The leads are not matched correctly with the car's accessory power connector.

During playback or reception, demonstration mode starts.

- If no operation is performed for 5 minutes with "DEMO-ON" set, demonstration mode starts.
→ Set "DEMO-OFF" (page 17).

The display disappears from/does not appear in the display window.

- The dimmer is set "DIM-ON" (page 17).
- The display disappears if you press and hold (OFF).
 - Press and hold (OFF) on the unit until the display appears.
- The connectors are dirty (page 20).

The Auto Off function does not operate.

The unit is turned on. The Auto Off function activates after turning off the unit.

→ Turn off the unit.

The display disappears while the unit is operating.

The Black Out function is set to on (page 17).

Card remote commander operation is not possible.

If the Black Out function is activated (no lighting), card remote commander operation is not possible (page 17).

CD playback

The disc cannot be loaded.

- Another disc is already loaded.
- The disc has been forcibly inserted upside down or in the wrong way.

The disc does not playback.

- Defective or dirty disc.
- The CD-Rs/CD-RWs are not for audio use (page 19).

MP3/WMA/AAC files cannot be played back.

The disc is incompatible with the MP3/WMA/AAC format and version. For details on playable discs and formats, visit the support site.

MP3/WMA/AAC files take longer to play back than others.

The following discs take a longer time to start playback.

- a disc recorded with a complicated tree structure.
- a disc recorded in Multi Session.
- a disc to which data can be added.

The display items do not scroll.

- For discs with very many characters, those may not scroll.
- "A.SCRL" is set to "OFF."
 - Set "A.SCRL-ON" (page 17).
 - Press and hold (DSPL) (SCRL).

The sound skips.

- Installation is not correct.
 - Install the unit at an angle of less than 45° in a sturdy part of the car.
- Defective or dirty disc.

The operation buttons do not function.

The disc will not eject.

Press the RESET button (page 6).

Radio reception

The stations cannot be received.

The sound is hampered by noises.

- The connection is not correct.
 - Connect a power antenna (aerial) control lead (blue) or accessory power supply lead (red) to the power supply lead of a car's antenna (aerial) booster (only when your car has built-in FM/AM antenna (aerial) in the rear/side glass).
 - Check the connection of the car antenna (aerial).
 - If the auto antenna (aerial) will not go up, check the connection of the power antenna (aerial) control lead.

Preset tuning is not possible.

- Store the correct frequency in the memory.
- The broadcast signal is too weak.

Automatic tuning is not possible.

- Setting of the local seek mode is not correct.
 - Tuning stops too frequently:
 - Set "LOCAL-ON" (page 17).
 - Tuning does not stop at a station:
 - Set "LOCAL-OFF" (page 17).
- The broadcast signal is too weak.
 - Perform manual tuning.

During FM reception, the "ST" indication flashes.

- Tune in the frequency accurately.
- The broadcast signal is too weak.
 - Set "MONO-ON" (page 17).

An FM program broadcast in stereo is heard in monaural.

The unit is in monaural reception mode.

→ Set "MONO-OFF" (page 17).

USB playback

You cannot play back items via a USB hub.

This unit cannot recognize USB devices via a USB hub.

Cannot play back items.

A USB device does not work.

→ Reconnect it.

The USB device takes longer to play back.

The USB device contains files with a complicated tree structure.

A beep sounds.

During playback, the USB device has been disconnected.

→ Before disconnecting a USB device, make sure to stop playback first for data protection.

The sound is intermittent.

The sound may be intermittent at a high-bit-rate of more than 320 kbps.

Error displays/Messages

CHECKING

The unit is confirming the connection of a USB device.
→ Wait until confirming the connection is finished.

ERROR*1

- The disc is dirty or inserted upside down.*2
→ Clean or insert the disc correctly.
 - A blank disc has been inserted.
 - The disc cannot play due to a problem.
→ Insert another disc.
 - USB device was not automatically recognized.
→ Reconnect it again.
 - Press **▲** to remove the disc.
-

FAILURE

The connection of speakers/amplifiers is incorrect.
→ See the installation guide manual of this model to check the connection.

HUB NO SUPRT

USB hub is not supported on this unit.

LOAD

The CD changer is loading the disc.
→ Wait until loading is complete.

L. SEEK +/-

The local seek mode is on during automatic tuning.

NO DEV (No Device)

(SOURCE) is selected without a USB device connected. A USB device or a USB cable has been disconnected during playback.
→ Be sure to connect a USB device and USB cable.

NO DISC

The disc is not inserted in the CD changer.
→ Insert discs in the CD changer.

NO MAG

The disc magazine is not inserted in the CD changer.
→ Insert the disc magazine in the CD changer.

NO MUSIC

The disc or USB device does not contain a music file.
→ Insert a music CD in this unit or an MP3 playable CD changer.
→ Connect a USB device with a music file in it.

NO NAME

A disc/album/artist/track name is not written in the track.

OFFSET

There may be an internal malfunction.
→ Check the connection. If the error indication remains on in the display, consult your nearest Sony dealer.

OVERLOAD

USB device is overloaded.
→ Disconnect the USB device, then change the source by pressing (SOURCE).
→ Indicates that the USB device is out of order, or an unsupported device is connected.

READ

The unit is reading all track and album information on the disc.

→ Wait until reading is complete and playback starts automatically. Depending on the disc structure, it may take more than a minute.

RESET

The CD unit, CD changer or USB device cannot be operated due to a problem.

→ Press the RESET button (page 6).

USB NO SUPRT (USB Not Support)

The connected USB device is not supported.

→ Connect a USB device of Mass Storage Class.

“LLLLL” or “rrrrr”

During reverse or fast-forward, you have reached the beginning or the end of the disc and you cannot go any further.

“—”

The character cannot be displayed with the unit.

*1 If an error occurs during playback of a CD, the disc number of the CD does not appear in the display.

*2 The disc number of the disc causing the error appears in the display.

If these solutions do not help improve the situation, consult your nearest Sony dealer.

If you take the unit to be repaired because of CD playback trouble, bring the disc that was used at the time the problem began.

SONY®

FM/AM Compact Disc Player

PR _____ دستور العمل های عملیاتی

برای لغو نمونه نمایشی (DEMO)، صفحه 6 را ملاحظه نمایید.

CDX-GT686UI
CDX-GT680UI

<http://www.sony.net/>

Sony Corporation Printed in Thailand

