

# Compact Disc Compact Player

## Operating Instructions

### About area code

The area code of the player you purchased is shown on upper left of the bar code label on the package. For accessories supplied with your player, check the area code of your model and refer to "Supplied accessories" toward the end of this manual.



- D-E700
- D-E705
- D-E706CK
- D-E800
- D-E805

Sony Corporation ©1998 Printed in Malaysia

# Playing a CD right away!

If you want to play a CD right now, choose to use your player on house current. Other choices are the following three: rechargeable battery, dry batteries (see "Power Sources" on the reverse side) and car battery.

## 1 Connect

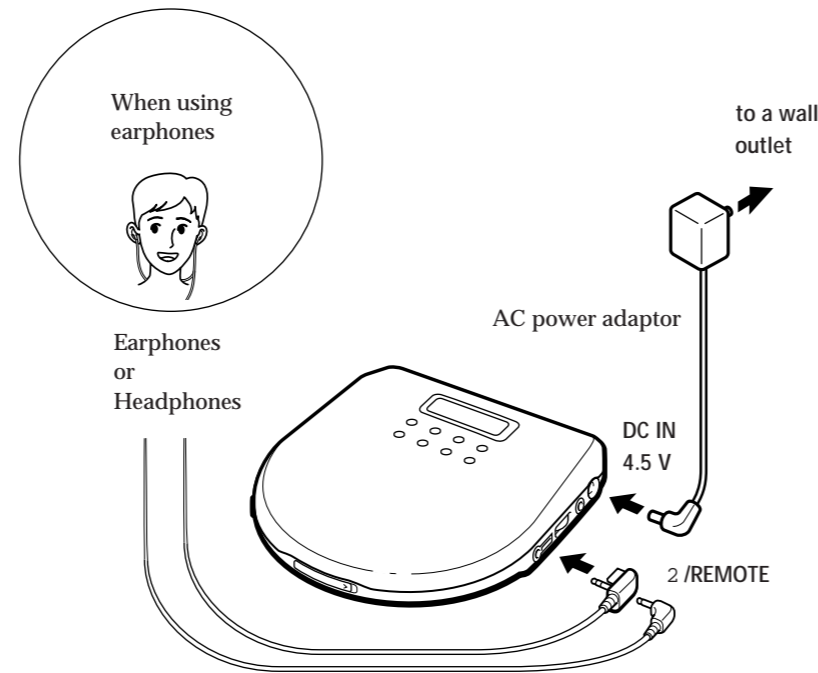

For models supplied with the AC plug adaptor  
If the AC power adaptor does not fit the wall outlet, use the AC plug adaptor.

For models supplied with the remote control

- Connect the microplug of the earphones to the remote control, not to the 2 /REMOTE jack of the player.
- Connect the earphones to the remote control firmly. A loose connection may cause noise during playback.

## 2 Place a CD

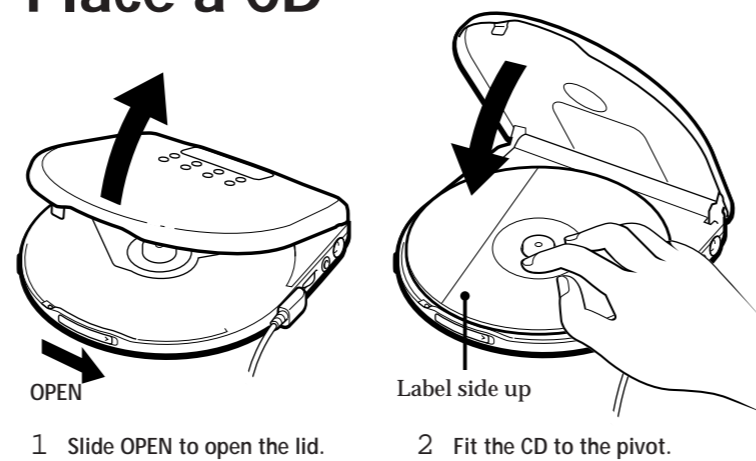

## 3 Play

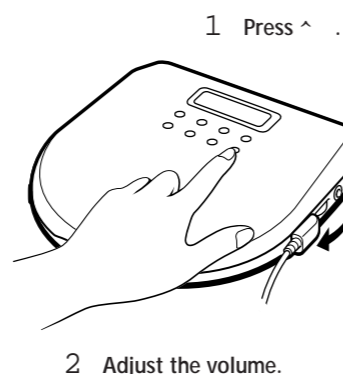

### To use the remote control

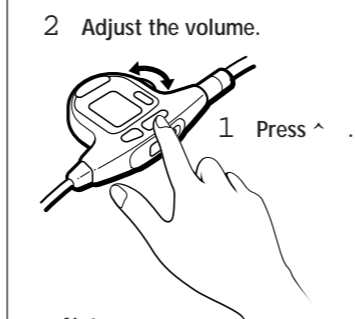

**Note**  
The shape of the remote control supplied with the U2 model is different from this one. To start play, press  $\blacktriangleright$ .

To stop play, press  $\square$ .

| To  | Press           |
|---|-----------------|
| Pause   | $\wedge$ *      |
| Resume play after pause                         | $\wedge$        |
| Find the beginning of the current track (AMS**) | = once***       |
| Find the beginning of previous tracks (AMS)     | = repeatedly*** |
| Find the beginning of the next track (AMS)      | + once***       |
| Find the beginning of succeeding tracks (AMS)   | + repeatedly*** |
| Go forward quickly                              | Hold down + *** |
| Go backwards quickly                            | Hold down = *** |

\*You cannot set the player in pause using the remote control (RM-DM29) supplied with the U2 model.  
\*\*AMS = Automatic Music Sensor  
\*\*\*These operations are possible during both play and pause.

**To remove the CD**  
Remove the CD while pressing the pivot.

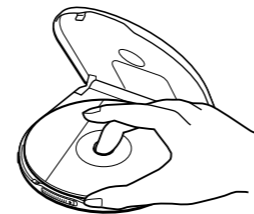

**Notes on controlling the volume with the remote control**  
Set the VOL (volume) control on the remote control to MAX. Then adjust the volume on the player to the level that you want to be the maximum volume of the remote control.

**Notes on display**

- When you press  $\wedge$  (when RESUME is set to OFF), the total number of tracks in the CD and the total playing time appear for about 2 seconds.
- During play, the track number and the elapsed playing time of the current track appear.
- During pause, the elapsed playing time appears.
- Between tracks, the time to the beginning of the next track will appear with the "--" indication.

**Illumination of the display (D-E800/E805 only)**  
When using the player on the AC power adaptor or car battery, the display is always illuminated. (Light of the display goes out when you press  $\square$  and the CD stops.)  
When you use the player on the rechargeable battery or alkaline batteries, the display is illuminated for about five seconds when you press any operation button. But, when using the optical digital connecting cord, the display is not illuminated.  
You can turn off the illumination of the display by first removing the rechargeable batteries or alkaline batteries; then while pressing the PLAY MODE button, reinsert the batteries.

**Notes on handling CDs**

- To keep the CD clean, handle it by its edge. Do not touch the surface.
- Do not stick paper or tape onto the CD.
- Do not expose the CD to direct sunlight or heat sources such as hot air ducts. Do not leave the CD in a car parked under direct sunlight.

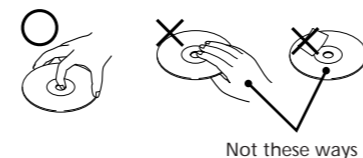

## z Other Operations

### Playing tracks repeatedly (Repeat Play)

You can play tracks repeatedly in normal, INTRO PGM, shuffle or RMS (Random Music Sensor) play modes. Repeat all the tracks or only one track.

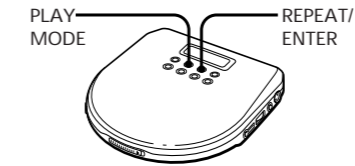

**To repeat all the tracks**  
Press REPEAT/ENTER during play. The "↺" indication appears.

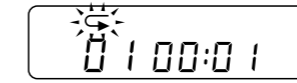

To cancel repeat play, press REPEAT/ENTER again.

**To repeat a single track**  
1 Press REPEAT/ENTER while the track you want to repeat is playing. The "↺" indication appears.

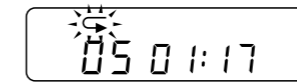

2 Press PLAY MODE repeatedly until "1" appears.

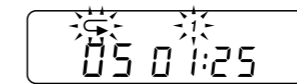

To repeat another track, press = or +.

To cancel repeat play, press REPEAT/ENTER again.

### Playing only the tracks you want (INTRO PGM Play)

You can choose and play your favorite tracks by scanning through the beginning of each track in a CD.

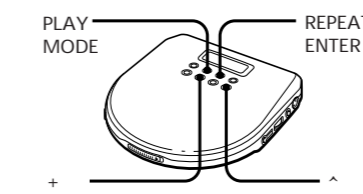

1 During play, press PLAY MODE repeatedly until "INTRO PGM" flashes.

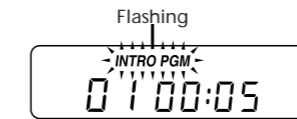

2 Press  $\wedge$  to start scanning. The player plays about the first 15 seconds of each track and "INTRO PGM" flashes faster.

3 Press REPEAT/ENTER while the track you want is playing. To skip the track, press + or just wait for the next track.

After you have gone through the CD, "INTRO PGM" stops flashing and the tracks you have chosen play automatically.

To finish programming before going through the whole CD, press  $\wedge$ . The selected tracks will be played.

If you press  $\square$ , the program will be erased. To prevent accidental erasure, set the RESUME switch to ON.

To cancel INTRO PGM play, press PLAY MODE repeatedly until the play mode indication disappears from the display.

### Playing tracks in random order (Shuffle Play)

You can play the tracks in a CD in random order.

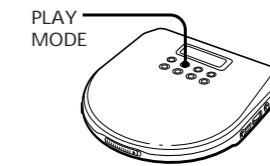

During play, press PLAY MODE repeatedly until "SHUF" appears. The tracks play in random order.

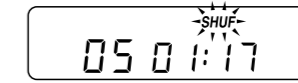

To cancel shuffle play, press PLAY MODE repeatedly until the play mode indication disappears from the display.

**Note**  
• During shuffle play, you cannot return to previous tracks by pressing =.

### Playing tracks in the order you want (RMS play)

You can program up to 22 tracks to play in any order you choose.

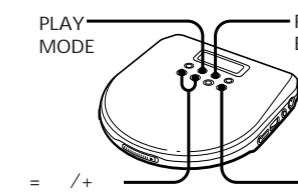

1 During play, press PLAY MODE repeatedly until "RMS" flashes.

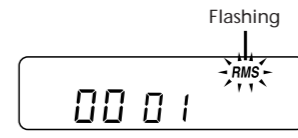

\*RMS = Random Music Sensor

2 Press = or + to choose a track. The track number and the playing order appear.

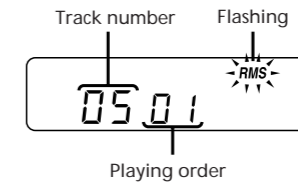

3 Press REPEAT/ENTER to program the track.

4 Repeat steps 2 and 3 to program the remaining tracks.

5 Press  $\wedge$ . "RMS" stops flashing and the tracks you have chosen play in the order you specified.

If you press  $\square$ , the program will be erased. To prevent accidental erasure, set the RESUME switch to ON.

To cancel RMS play, press PLAY MODE until "RMS" disappears.

### To check the program

During programming:  
Press REPEAT/ENTER before step 5.  
During RMS play:  
Press PLAY MODE repeatedly until "RMS" flashes, then press REPEAT/ENTER. Each time you press REPEAT/ENTER, the track number and the playing order appear in the order you specified.

**Note**  
• If you program another track after the 22nd track, the first track programmed is cleared and the new track is programmed instead.

## Using other functions

**To minimize skipping (ESP<sup>2</sup>)**  
The ESP (Electronic Shock Protection) function minimize skipping by using a buffer memory that stores music data and plays it back in the event of a shock. The new ESP<sup>2</sup> (ESP Squared) system uses a new DSP (Digital Signal Processor) which can read and store music data more efficiently, providing a level of continuous skip protection not found in traditional buffer memory units. This decreases the frequency of sound skipping and the need to utilize the buffer memory. Use this function when listening in a car or while walking.\*  
\* Although ESP<sup>2</sup> provides excellent protection against skipping, it will not prevent skipping while jogging or running.

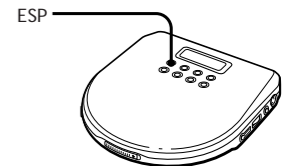

Press ESP. The ESP indication appears.

To release the ESP function, press ESP again.

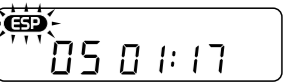

**Notes**

- Playing may stop when the player gets a strong shock even with the ESP function on.
- You may hear a noise or sound skip when:
  - listening to a dirty or scratched CD,
  - listening to an audio test CD or,
  - the player receives continuous shock.
- Sound may drop for a while if you press ESP during play.
- When you use an optical digital connecting cord, the ESP function will be disabled.

### To enjoy more powerful bass sound (Sound function)

You can enjoy a powerful bass-boosted sound.

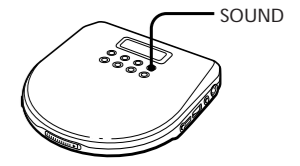

Press SOUND to select "BASS" or "GROOVE." "GROOVE" is more effective.

**Note**  
• If the sound is distorted when emphasizing bass, turn down the volume.

**To lock the buttons**  
You can lock your player against any accidental operations. You can still operate the player with the remote control.

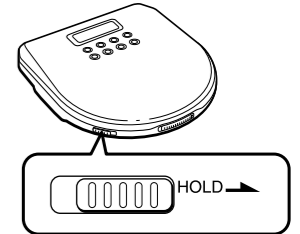

Slide HOLD in the direction of the arrow. When you press any button, "Hold" appears in the display and you cannot operate the player.

To unlock, slide HOLD back.

Continue to the reverse side m

## Welcome!

Thank you for purchasing the Sony Compact Disc Compact Player. Before operating your player, please read this manual and retain it for future reference.

### About this manual

The instructions in this manual are for the D-E700, D-E705, D-E706CK, D-E800 and D-E805. Before you start reading, check your model number.

### Owner's Record

The model and the serial numbers are located at the bottom. Record these numbers in the spaces provided below. Refer to them whenever you call upon your Sony dealer regarding this product.

Model No. \_\_\_\_\_ Serial No. \_\_\_\_\_

## WARNING

**To prevent fire or shock hazard, do not expose the unit to rain or moisture.**

**To avoid electrical shock, do not open the cabinet. Refer servicing to qualified personnel only.**

### CAUTION

The use of optical instruments with this product will increase eye hazard.

## INFORMATION

Listening for many hours at maximum volume may damage your hearing.

### For the customers in the USA

This equipment has been tested and found to comply with the limits for a Class B digital device, pursuant to Part 15 of the FCC Rules. These limits are designed to provide reasonable protection against harmful interference in a residential installation. This equipment generates, uses, and can radiate radio frequency energy and, if not installed and used in accordance with the instructions, may cause harmful interference to radio communications. However, there is no guarantee that interference will not occur in a particular installation. If this equipment does cause harmful interference to radio or television reception, which can be determined by turning the equipment off and on, the user is encouraged to try to correct the interference by one or more of the following measures:

- Reorient or relocate the receiving antenna.
- Increase the separation between the equipment and receiver.
- Connect the equipment into an outlet on a circuit different from that to which the receiver is connected.
- Consult the dealer or an experienced radio/TV technician for help.

You are cautioned that any changes or modifications not expressly approved in this manual could void your authority to operate this equipment.

### For the customers in Australia

The supply cord of the AC power adaptor cannot be replaced; if the cord is damaged, the AC power adaptor should be discarded.

### For the customers not in Poland

The  $\square$  mark on the unit is valid only for products marketed in Poland.

### For the customers not in Europe

The CE mark on the unit is valid only for products marketed in the European Union.

### For the customers not in Russia

The  $\square$  mark on the unit and package is valid only for products marketed in Russia.

**To protect your hearing (AVLS)**  
The AVLS (Automatic Volume Limiter System) function keeps down the maximum volume to protect your ears.

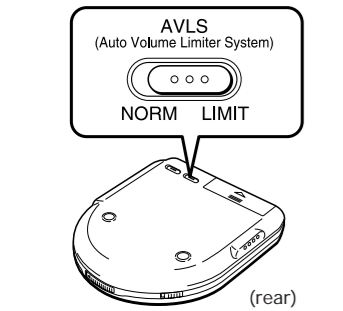

Set AVLS to LIMIT.  
The AVLS indication appears.

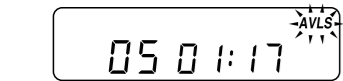

**Note**  
• If the sound is distorted when you listen to the bass-boosted sound with the AVLS function, turn down the volume.

### To resume playing from the point you stopped the CD (Resume Play)

Normally, every time you stop and play, playing starts from the beginning of the CD. The resume play function, however, let you listen to from the point at which you last turned off the player.

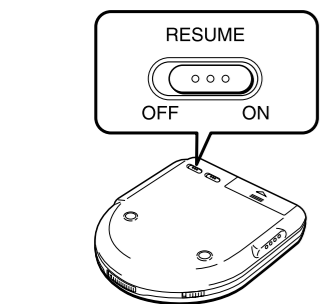

Set RESUME to ON.

To cancel resume play, set RESUME to OFF.

### Notes

- Even if RESUME is set to ON, playing starts from the beginning when you open the lid.
- The resume point may be inaccurate by about 30 seconds.

### To turn off the beep

You can turn off the beep that sounds as you operate your player.

Disconnect the power source (AC power adaptor, rechargeable battery or alkaline batteries). While you press and hold down  $\mathbb{P}$ , connect the power source again. To make the beep sound again, disconnect the power source, and then connect it without pressing  $\mathbb{P}$ .

## Connecting to other stereo equipment

You can listen to the CD through other stereo equipment or record a CD on a cassette tape or a MiniDisc. Refer to the instruction manual of the other equipment for details. Before making connections, turn off each piece of equipment.

### Using the connecting cord

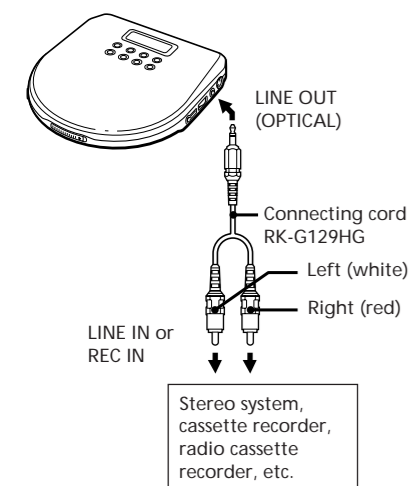

### Note

- When you use a connecting cord, the SOUND function will be disabled.

### Using the optical digital connecting cord

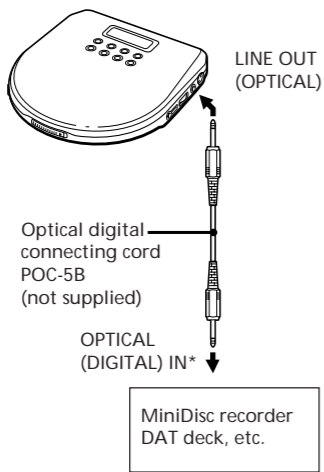

\*If the OPTICAL (DIGITAL) IN jack is square-shaped, use the POC-5AB optical digital connecting cord instead.

### Notes on connecting to other stereo equipment

- Before you play the CD, turn down the volume of the connected equipment so as not to damage the connected speakers.
- The beep sound is not output from the LINE OUT (OPTICAL) jack.
- When you connect other equipment to the LINE OUT (OPTICAL) jack of this player, adjust the volume on the connected equipment.
- When you record a CD on a cassette tape using a tape recorder that has the blank search function, release the ESP function. If the ESP function is on, the blank search function does not work.

### Recording with optical digital connection

Record a CD on a MiniDisc, DAT, etc., according to the following procedure.

- 1 Press  $\wedge$  on the player to start play.
- 2 Press  $\wedge$  again to pause.
- 3 Press = / + to select the track you want to record.
- 4 Press  $\mathbb{R}$  (record) on the MiniDisc recorder, DAT recorder, etc.
- 5 Press  $\wedge$  on the player to release pause.

### Notes

- Connect the optical digital connecting cord while the player is in stop mode.
- If you record without pausing the player, some CD may have problem with recording the first track number correctly.
- The beep sound works on the output from the 2 / REMOTE jack, but does not work on that from the LINE OUT (OPTICAL) jack.
- When use an optical digital connecting cord, the ESP function will be disabled.

### Playing a CD in a car

You can use your player in a car by connecting it to the car cassette deck.

You cannot use the car mount plate for this player.

When you use the player in a car, install it securely in a location which does not interfere your driving.

To connect your player to a car cassette deck, you need the following accessories:

- Car connecting pack CPA-9
- Car battery cord DCC-E245 or,
- Car battery cord with car connecting pack DCC-E28CP

Refer to the instruction manual of each accessory for details.

### Notes

- Do not put the player on the dashboard.
- Do not leave the player in a car parked under sunlight.
- Use a Sony car connecting pack for reducing noise.
- Use only the car battery cord listed in the recommended accessories. If you use any other car battery cord, smoke, fire or malfunction may occur.

### Switched ignition function (when using the car battery cord)

With this feature, your player stops automatically when you turn off the engine of the car. (This function is not possible with some cars depending on the model).

## Using the supplied remote control

For the customers supplied with the RM-DM27L/RM-DM28L remote control  
You can use the remote control as the wired remote control.

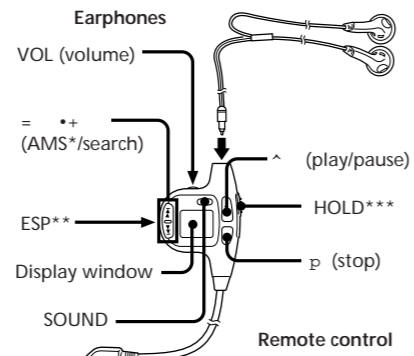

In the stop mode, you can start play by pressing = / + (AMS/search) as well as  $\wedge$ .

- \* Automatic Music Sensor
- \*\* Electronic Shock Protection
- \*\*\*When you are not using the remote control, slide HOLD in the direction of the arrow to prevent any accidental operations. To unlock, slide HOLD back.

### Display window

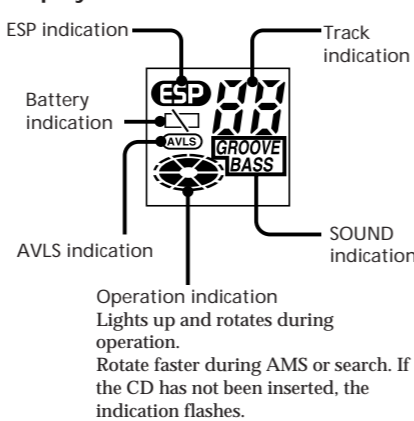

### For the customers supplied with the RM-DM28EL remote control

When using the player on the AC power adaptor or car battery, the display is always illuminated. (Light of the display goes out when you press  $\mathbb{P}$  and the CD stops.)

When you use the player on the rechargeable battery or alkaline batteries, the display is illuminated for about five seconds when you press any operation button. But, when using the optical digital connecting cord, the display is not illuminated.

You can turn off the illumination of the display by first removing the rechargeable batteries or alkaline batteries; then while pressing the PLAY MODE button, reinsert the batteries.

### For the customers supplied with the RM-DM29 remote control

You can use the remote control as the wired remote control.

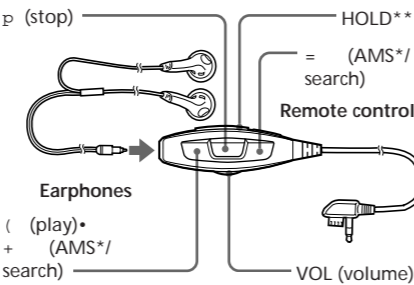

- \* Automatic Music Sensor
- \*\* When you are not using the remote control, slide HOLD in the direction of the arrow to prevent any accidental operations. To unlock, slide HOLD back.

### Note

- Use only the supplied remote control. You cannot operate this player with the remote control supplied with other models.

### When connecting optional headphones to the supplied remote control

Use only headphones with micro plugs. You cannot use headphones with stereo mini plugs.

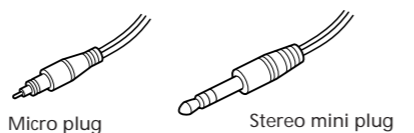

## Power Sources

### Using rechargeable batteries

Charge the rechargeable batteries before using them for the first time.  
Use the NH-DM2AA rechargeable batteries (supplied) for this player. You cannot use any other rechargeable batteries.

- 1 Open the lid of the battery compartment.

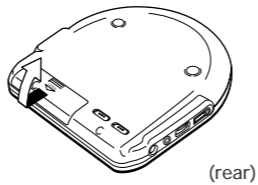

- 2 Insert two rechargeable batteries NH-DM2AA by matching the  $\oplus$  and  $\ominus$  to the diagram inside the battery compartment and close the lid.

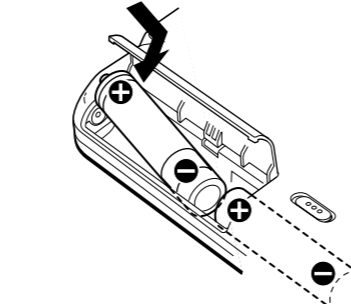

- 3 Connect the AC power adaptor. The indication "CHG" lights up. Charge for about 4 hours. (If the battery has been already charged, "CHG" and  $\mathbb{P}$  flash.)

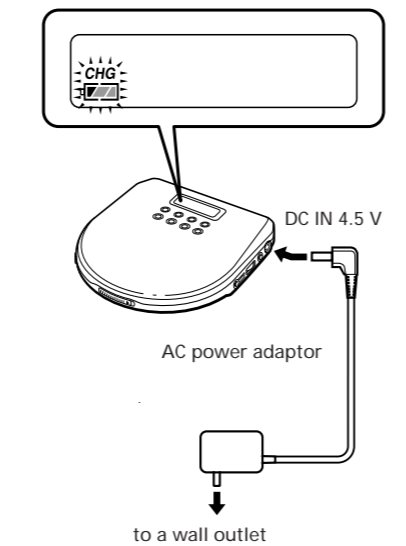

- 4 When fully charged, "CHG" disappears. Disconnect the AC power adaptor.

### To take out the rechargeable batteries

Take out the batteries in the proper way as illustrated inside the lid or shown below.

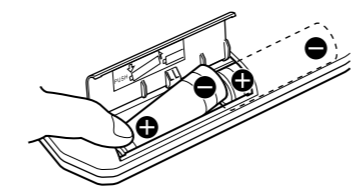

### When to charge the rechargeable batteries

When the rechargeable batteries become weak,  $\mathbb{P}$  indication appears in the display. If the "Lo ba tt" appears in the display, charge the rechargeable batteries, because the batteries are used up.  
To keep the original battery capacity for a long time, recharge the batteries when the batteries are used up (discharged).

### When carrying the rechargeable battery

Make sure to use the supplied battery carrying case.  
If you carry the rechargeable battery with a metal object, short circuit, smoke or fire may occur.

### Notes

- Charging time varies depending on how the rechargeable battery is used.
- If the battery is new or has not been used for a long time, it may not be charged completely until you charge and discharge it several times.
- If the battery life becomes shorter by about half, replace it with Sony NH-DM2AA rechargeable battery. Do not use any other rechargeable battery.
- The supplied rechargeable batteries are only for this player. You cannot use them for other models.

### Using dry batteries

Insert the batteries properly in the same way as the rechargeable batteries.

- 1 Disconnect the AC power adaptor and open the lid of the battery compartment.

- 2 Insert two LR6 (size AA) alkaline batteries by matching the  $\oplus$  and  $\ominus$  to the diagram inside the battery compartment and close the lid.

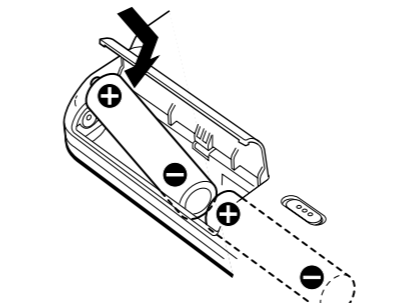

### Note

- Do not use manganese batteries for this player.

### To take out the dry batteries

Take out the batteries properly in the same way as the rechargeable batteries.

### When to replace the dry batteries

When the battery becomes weak,  $\mathbb{P}$  indication appears in the display. If the batteries are used up, "Lo ba tt" appears in the display. Replace all the batteries with new ones.

### Notes

- Do not charge the dry batteries.
- Do not mix new batteries with old ones.
- Do not use different types of batteries together.
- When the batteries are not to be used for a long time, remove them.
- If the battery leakage occurs, wipe off any deposit in the battery compartment, and install new batteries.

### Battery life (approx. hours) (EIAJ\*)

| When using                                 | ESP function |    |
|--|--------------|----|
|  | off          | on |
| Two NH-DM2AA (charged for about 4 hours**) | 12           | 11 |
| Two alkaline batteries LR6SG               | 20           | 18 |

\*Measured value by the standard of EIAJ (Electronic Industries Association of Japan) (When you use the player on a flat and stable place; When you do not use the optical digital connecting cord)  
\*\*Charging time varies depending on how the rechargeable battery is used.

### How to attach the battery compartment lid

If the battery compartment lid is detached by an accidental drop, excessive force, etc., attach it as illustrated in the numbered order.

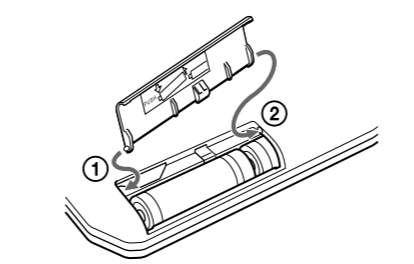

## Additional Information

### Precautions

#### On safety

- Should any solid objects or liquid fall into the player, unplug it and have it checked by qualified personnel before operating it any further.
- Do not put any foreign objects in the DC IN 4.5 V (external power input) jack.

#### On power sources

- When you are not using the player for a long time, disconnect all power sources from the player.

#### On the AC power adaptor

- Use only the supplied AC power adaptor. If your player is not supplied with it, use AC-E45HG AC power adaptor. Do not use any other AC power adaptor.

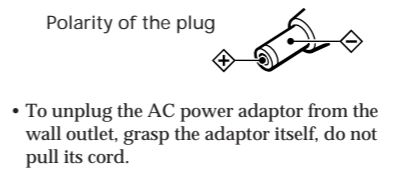

This player is designed so that it cannot charge any other rechargeable batteries or dry batteries for safety reasons.

The supplied rechargeable batteries (NH-DM2AA)

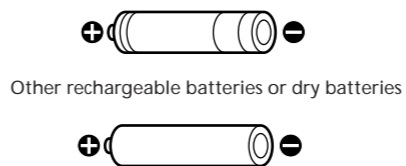

Other rechargeable batteries or dry batteries

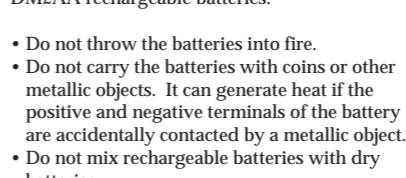

When you replace the rechargeable batteries with new ones, make sure to use the NH-DM2AA rechargeable batteries.

### On the player

- Keep the lens on the player clean and do not touch it. If you do so, the lens may be damaged and the player will not operate properly.
- Do not put any heavy object on top of the player. The player and the CD may be damaged.
- Do not leave the player in a location near heat sources, or in a place subject to direct sunlight, excessive dust or sand, moisture, rain, mechanical shock, unlevelled surface, or in a car with its windows closed.
- If the player causes interference to the radio or television reception, turn off the player or move it away from the radio or television.
- Do not wrap the player in a cloth or blanket during use as it may cause malfunction or serious accidents.

### On headphones/earphones Road safety

Do not use headphones/earphones while driving, cycling, or operating any motorized vehicle. It may create a traffic hazard and is illegal in some areas. It can also be potentially dangerous to play your headphones at high volume while walking, especially at pedestrian crossings. You should exercise extreme caution or discontinue use in potentially hazardous situations.

### Preventing hearing damage

Avoid using headphones/earphones at high volume. Hearing experts advise against continuous, loud and extended play. If you experience a ringing in your ears, reduce volume or discontinue use.

### Caring for others

Keep the volume at a moderate level. This will allow you to hear outside sounds and to be considerate to the people around you.

## Maintenance

### To clean the lens

Clean the lens with a lens cleaning kit KK-DM1.

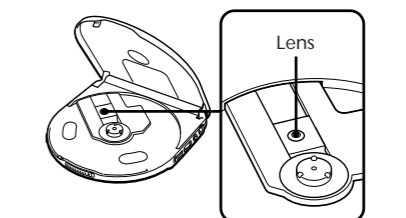

### To clean the casing

Use a soft cloth slightly moistened in water or a mild detergent solution. Do not use alcohol, benzine or thinner.

## Troubleshooting

Should any problem persist after you have made these checks, consult your nearest Sony dealer.

### The CD does not play or "no disc" appears in the display though a CD is placed in the player.

- m The CD is dirty or defective.
- m Insert the CD with the label side up.
- m Moisture condensation has occurred. Leave the player aside for several hours until the moisture evaporates.
- m The lens is dirty.
- m Close the lid of the player and the battery compartment firmly.
- m Make sure the batteries are inserted correctly.
- m Connect the AC power adaptor to a wall outlet securely.

### When you press $\wedge$ , "00" appears in the display for a moment, and disappears. The CD does not play.

- m Rechargeable battery or dry batteries are used up. Charge the rechargeable battery or replace dry batteries with new ones.

### No sound, or noise is heard.

- m Connect the plugs firmly.
- m Plugs are dirty. Clean the plugs with a dry soft cloth periodically.

### "Hl d c ln" appears in the display.

- m Use only the supplied AC power adaptor or recommended AC power adaptor AC-E45HG (not supplied).
- m Use only the car battery cord listed in the Recommended accessories.

### "Hold" appears in the display when you press a button.

- m The buttons are locked. Slide HOLD back.

### "Lo ba tt" appears in the display when you press a button.

- m The rechargeable batteries are used up completely. Connect the AC power adaptor and charge the batteries.
- m The dry batteries are use up. Replace them with new ones.

### The battery life is short.

- m Manganese batteries are used. Use alkaline batteries.
- m Replace the batteries with new ones.

### During recording with optical digital connection, the track number cannot be recorded correctly.

- m Record the track number again using the MiniDisc recorder, DAT recorder, etc.
- m Record again according to the procedure shown in the section "Connecting to other stereo equipment."

Design and specifications are subject to change without notice.

### For US customers

AC power adaptor supplied is not intended to be serviced. Should the AC power adaptor cease to function in its intended manner, during the warranty period, the adaptor should be returned to your nearest Sony Service Center or Sony Authorized Repair Center for replacement, or after warranty period, it should be discarded.

### Recommended accessories

- Car connecting pack CPA-9
- Car battery cord with car connecting pack DCC-E28CP
- Car battery cord DCC-E245
- Active speaker system SRS-A21, SRS-A41, SRS-A71
- Rechargeable battery NH-DM2AA
- Connecting cord RK-G129HG
- Optical digital connecting cord POC-5B, POC-10B, POC-15B, POC-5AB, POC-10AB, POC-15AB
- AC power adaptor AC-E45HG
- Stereo headphones MDR-35, MDR-E848LP

Your dealer may not handle some of the above listed accessories. Please ask the dealer for detailed information about the accessories in your country.

Output (at 4.5 V input level)  
Headphones (stereo minijack)  
15 mW + 15 mW at 16 ohms  
Line output (stereo minijack)  
Output level 0.7 V rms at 47 kilohms  
Recommended load impedance over 10 kilohms  
Optical digital output (optical output connector)  
Output level: -21 ~ -15 dBm  
Wavelength: 630 - 690 nm at peak level

### General Power requirements

For the area code of the model you purchased, check the upper left side of the bar code on the package.

- Two Sony NH-DM2AA Rechargeable batteries: 2.4 V DC
- Two LR6 (size AA) batteries: 3 V DC
- AC power adaptor (DC IN 4.5 V jack): U2/CA2/E92 model: 120 V, 60 Hz CED/CEF/EE1/E13 model: 220 - 230 V, 50/60 Hz CEK model: 230 - 240 V, 50 Hz EA3 model: 110 - 240 V, 50/60 Hz AU2 model: 240 V, 50 Hz JE.W/E33 model: 100 - 240 V, 50/60 Hz HK2 model: 220 V, 50/60 Hz CN2 model: 220 V, 50 Hz
- Sony DCC-E245 car battery cord for use on car battery: 4.5 V DC

### Dimensions (w/h/d) (without projecting parts and controls)

- D-E700/E705/E706CK: Approx. 131.8 × 23.9 × 142.0 mm (5 1/4 × 3/8 × 5 5/8 in.)
- D-E800/E805: Approx. 131.8 × 23.7 × 142.0 mm (5 1/4 × 15/16 × 5 5/8 in.)

### Mass (without rechargeable batteries)

- Approx. 210 g (7.4 oz)

### Operating temperature

- 5°C - 35°C (41°F - 95°F)

### Supplied accessories

For the area code of the model you purchased, check the upper left side of the bar code on the package.

- D-E700/E705
- AC power adaptor (1)
- Headphones (1)\*<sup>1</sup>
- Earphones with remote control (1)\*<sup>2</sup>
- Rechargeable batteries (2)\*<sup>3</sup>
- Connecting cord (Phono plug × 2 ↔ stereo miniplug) (1)\*<sup>4</sup>
- AC plug adaptor (1)\*<sup>5</sup>
- Battery carrying case (1)\*<sup>3</sup>
- Carrying case (1)
- \*<sup>1</sup> Supplied with U2 model
- \*<sup>2</sup> Not supplied with U2 model
- \*<sup>3</sup> Not supplied with U2 and CA models
- \*<sup>4</sup> Not supplied with CED, CEX, EE1, CEK and JE.W models
- \*<sup>5</sup> Supplied with JE.W, E33 and E13 models

### D-E706CK

- AC power adaptor (1)
- Headphones (1)
- Rechargeable batteries (2)
- Battery carrying case (1)
- Carrying case (1)
- Car battery cord (1)
- Car connecting pack (1)
- Velcro tape (2)
- Spare fuse (1)
- Spiral tube (1)

### D-E800/E805

- AC power adaptor (1)
- Headphones with remote control (1)\*<sup>1</sup>
- Earphones with remote control (1)\*<sup>2</sup>
- Rechargeable batteries (2)
- Connecting cord (Phono plug × 2 ↔ stereo miniplug) (1)\*<sup>3</sup>
- AC plug adaptor (1)\*<sup>4</sup>
- Battery carrying case (1)
- Carrying case (1)
- \*<sup>1</sup> Supplied with U2 model
- \*<sup>2</sup> Not supplied with U2 model
- \*<sup>3</sup> Not supplied with CED, CEK, CEX and JE.W models
- \*<sup>4</sup> Supplied with JE.W, E33 and E13 models

Design and specifications are subject to change without notice.

### For US customers

AC power adaptor supplied is not intended to be serviced. Should the AC power adaptor cease to function in its intended manner, during the warranty period, the adaptor should be returned to your nearest Sony Service Center or Sony Authorized Repair Center for replacement, or after warranty period,