

R410A MULTI SPLIT SERIES ROOM AIR CONDITIONER

WALL MOUNTED TYPE INDOOR UNITS OPERATION & INSTALLATION MANUAL

AS072XHERA

AS092XHERA

AS122XHERA

- Please read this manual carefully before using this air conditioner.
- Please keep this manual safely for future use.

No.0010577054

■ Contents

Cautions	1-2
Safety precautions.....	3-5
Parts and Functions	6-7
Operation.....	8-18
Notes for safety	19
Operation and Maintenance	20
Trouble shooting	21-22
Customer Need-to-know	23
Instructions to installation.....	24-28
When trouble happens.....	29
Failure code	30

■ Cautions

Disposal of the old air conditioner

Before disposing an old air conditioner that goes out of use, please make sure it's inoperative and safe. Unplug the air conditioner in order to avoid the risk of child entrapment.

It must be noticed that air conditioner system contains refrigerants, which require specialized waste disposal. The valuable materials contained in a air conditioner can be recycled. Contact your local waste disposal center for proper disposal of an old air conditioner and contact your local authority or your dealer if you have any question. Please ensure that the pipework of your air conditioner does not get damaged prior to being picked up by the relevant waste disposal center, and contribute to environmental awareness by insisting on an appropriate, anti-pollution method of disposal.

Disposal of the packaging of your new air conditioner

All the packaging materials employed in the package of your new air conditioner may be disposed without any danger to the environment.

The cardboard box may be broken or cut into smaller pieces and given to a waste paper disposal service. The wrapping bag made of polyethylene and the polyethylene foam pads contain no fluorochloric hydrocarbon.

All these valuable materials may be taken to a waste collecting center and used again after adequate recycling.

Consult your local authorities for the name and address of the waste materials collecting centers and waste paper disposal services nearest to your house.

Safety Instructions and Warnings

Before starting the air conditioner, read the information given in the User's Guide carefully. The User's Guide contains very important observations relating to the assembly, operation and maintenance of the air conditioner.

The manufacturer does not accept responsibility for any damage that may arise due to non-observation of the following instructions.

- Damaged air conditioners are not to be put into operation. In case of doubt, consult your supplier.
- Use of the air conditioner is to be carried out in strict compliance with the relative instructions set forth in the User's Guide.
- Installation shall be done by professional people, and don't install the unit by yourself.
- For the purpose of safety, the air conditioner must be properly grounded in accordance with specifications.
- Always remember not to operate the air conditioner before opening its inlet grill.

■ Cautions

- All electrical repairs must be carried out by qualified electricians. Inadequate repairs may result in a major source of danger for the user of the air conditioner.
- Do not damage any parts of the air conditioner that carry refrigerant by piercing or perforating the air conditioner's tubes with sharp or pointed items, crushing or twisting any tubes, or scraping the coatings off the surfaces. If the refrigerant spurts out and gets into eyes, it may result in serious eye injuries.
- Do not obstruct or cover the ventilation grille of the air conditioner. Do not put fingers or any other things into the inlet/outlet and swing louver.
- Do not allow children to play with the air conditioner. In no case should children be allowed to sit on the outdoor unit.

Specifications

The refrigerating circuit is leak-proof.

The machine is adaptive in following situation

1. Applicable ambient temperature range:

			Rated	Maximum	Minimum
Cooling	Indoor	DB °C	27	32	18
		WB °C	19	23	14
	outdoor	DB °C	35	43	10
		WB °C	24	26	6
Heating	Indoor	DB °C	20	27	15
		WB °C	14.5	--	--
	outdoor	DB °C	7	24	-15
		WB °C	6	18	--

2. If the supply cord is damaged, it must be replaced by the manufacturer or its service agent or a similar qualified person.

3. If the fuse on PC board is broken, please change it with the type of T 3.15A /250VAC

4. The wiring method should be in line with the local wiring standard.

5. The power cable and connecting cable are self-provided.

The requirement of the connecting cable:

Model	Connecting cable(sheilded wire)
AS072XHERA AS092XHERA AS122XHERA	H05RN-F 3G 2.5mm ² H05RN-F 2X1.5mm ²

All the cables shall have got the Local authentication certificate.

6. The breaker of the air conditioner should be all-pole switch; and the distance between its two contacts should be no less than 3mm. Such means for disconnection must be incorporation in the fixed wiring.

7. The waste battery shall be disposed properly.

8. The indoor unit installation height is at least 2m.

9. The appliance is not intended for use young children or infirm persons without supervision.

10. Young children should be supervised to ensure that they do not play with the appliance.

■ Safety precautions

Carefully read the following information in order to operate the air conditioner correctly.

Below are listed three kinds of Safety Cautions and Suggestions.

WARNING! Incorrect operations may result in severe consequences of death or serious injuries.

CAUTION! Incorrect operations may result in injuries or machine damages; in some cases may cause serious consequences.

INSTRUCTIONS: These information can ensure the correct operation of the machine.

Be sure to conform with the following important Safety Cautions.

The Safety Cautions should be at hand so that they can be checked at any time when needed.

If the conditioner is transferred to the new user, this manual should be as well transferred to the new user.

WARNING!

- **Don't blow the human body with the cooling air too long, and don't let the room temperature decrease too low either.**

Otherwise the one will feel unpleasant or harm ones' health.

- **If any abnormal phenomena is found (e. g. smell of firing), please cut off the power supply immediately, and contact the dealer to find out the handling method.**

In such case, to continue using the conditioner will damage the conditioner, and may cause electrical shock or fire hazard.



- **When need maintenance and repairment, call dealer to handle it.**

Incorrect maintenance and repairment may cause water leak, electrical shock and fire hazard.

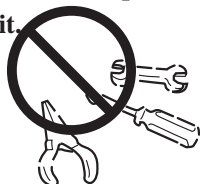

- **Please let the dealer be responsible for installing the conditioner.**

Incorrect installation may cause water leak, electrical shock and fire hazard.

- **Don't put fingers or any other things into the inlet/outlet and swing louver while the conditioner is in operation.**

Because the highspeed fan is very dangerous and may cause injuries.

- **Call the dealer to take measures to prevent the refrigerant from leaking.**

If conditioner is installed in a small room, be sure to take every measure in order to prevent suffocation accident even in case of refrigerant leakage.

- **When conditioner is deinstalled or reinstalled dealer should be responsible for them.**

Incorrect installation may cause water leaking, electrical shock and fire hazard.

■ Safety precautions

CAUTIONS!

- **Conditioner should not be used for any other purpose other than airconditioning.**

Don't use air-conditioner for any other special purposes, e.g. the preservation and protection of food, animals, plants, precision apparatus as well as work of art, otherwise the qualities of these stuffs may be damaged.

- **Don't dismantle the outlet of the outdoor unit.**

The exposure of fan is very dangerous which may harm human beings.



- **When air-conditioner is co-used with other heat-radiator the frequent replacement of room atmosphere should be required.**

Inefficient ventilation may cause suffocation.



- **After a long time use of air-conditioner the base should be checked for any damages.**

If the damaged base is not repaired, the unit may fall down and cause accidents.



- **No goods or nobody is permitted to be placed on or stand on outdoor unit.**

The falling of goods and people may cause accidents.



- **Pets and plants should not be blown directly in the air flow.**

Otherwise will suffer damage.

- **Don't operate the air-conditioner with damp hands.**

Otherwise will be shocked.



- **Only use correctly-typed fuse.**

May not use wire or any other materials replacing fuse, otherwise may cause faults or fire accidents.



- **Don't place any burning unit in the air flow of air-conditioner, which may cause incomplete combustion.**

- **No inflammable spray fluid should be permitted to be placed or used near to airconditioner other wise may cause fire accidents.**

- **Air-conditioner should be cleaned only after power supply is cut off to keep from shock or hurt.**

- **Don't clean air-conditioner with water.**

Otherwise may cause shock.

- **When use the fumigating insecticide don't open air-conditioner.**

Otherwise the poisonous chemicals may settle in air-conditioner which harm the health of chemical-allergic people.

■ Safety precautions

CAUTIONS ON INSTALLATION

Please ask the dealer or specialist to install, never try by the users themselves. After the installation please be sure of the following conditions.

- **Please call dealer to install the air-conditioner.**
Incorrect installation may cause water leaking, shock and fire hazard.

CAUTION !

- **Air-conditioner can't be installed in the environment with inflammable gases because the inflammable gases near to air-conditioner may cause fire hazard.**
- **Installed electrical-leaking circuit breaker.**
It easily cause electrical shock without circuit breaker.

[Location]

- Air-conditioner should be located in well-vented and easily-accessible place.
- Air-conditioner should not be located in the following places:
 - (a) Places with machine oils or other oil vapours.
 - (b) Seaside with high salt content in the air.
 - (c) Near to hot spring with high content of sulfide gases.
 - (d) Area with frequent fluctuation of voltage e.g. factory, etc.
 - (e) In vehicles or ships.
 - (f) Kitchen with heavy oil vapour or humidity.
 - (g) Near to the machine emitting electric-magnetic waves.
 - (h) Places with acid, alkali vapour.
- TV, radio, acoustic appliances etc are at least 1 m far away to the indoor unit, outdoor unit, power supply wire, connecting wire, pipes, otherwise images may be disturbed or noises be created.

- **Connect earthing wire.**

Earthing wire should not be connected to the gas pipe, water pipe, lightning rod or phone line, incorrect earthing may cause shock.



Earthing

- **Use discharge pipe correctly to ensure efficient discharge.**
Incorrect pipe use may cause water leaking.

- As required, take measures against heavy snow.

[Wiring]

- Air-conditioner should be equipped with special power supply wire.

[Operating noise]

- Chose the following locations:
 - (a) Capable of supporting air-conditioner weight, don't increase operating noise and vibration.
 - (b) Hot vapour from outdoor unit outlet and operating noise don't disturb neighbour.
- No obstacles around the outdoor unit outlet.

Parts and Functions

INDOOR UNIT FRONT VIEW

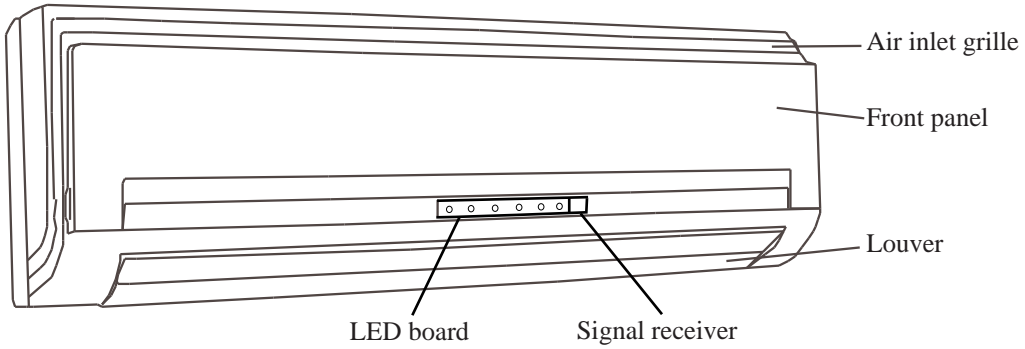

LED board

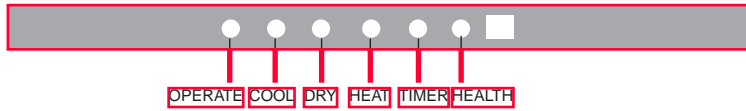

***HEALTH LED DISPLAY/PRESS HEALTH/FRESH/STERILIZE BUTTON**

INDOOR UNIT BACK VIEW

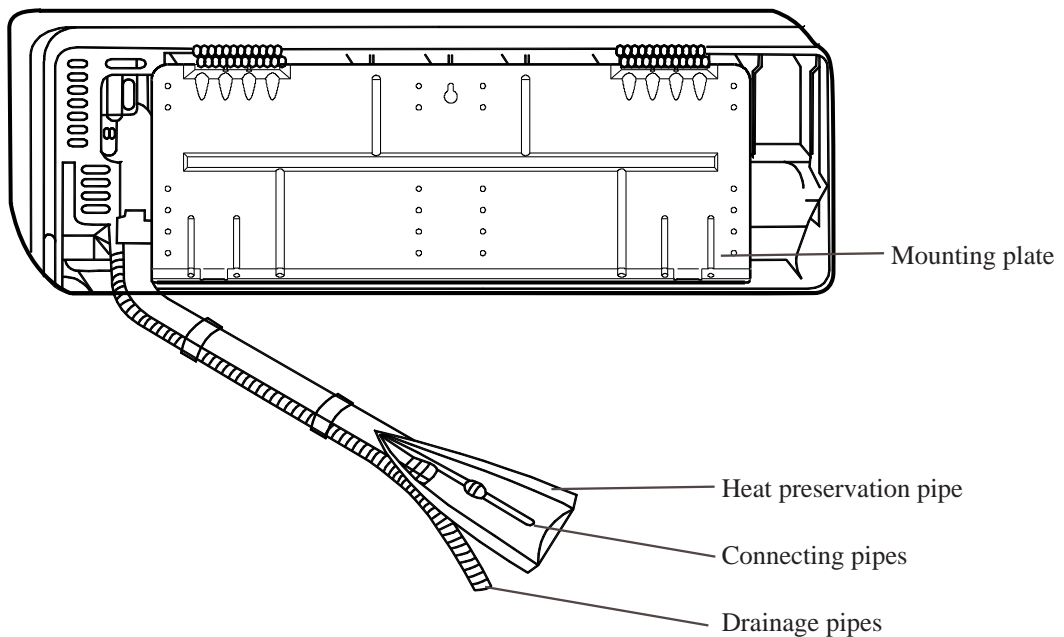

Parts and Functions

REMOTE CONTROLLER

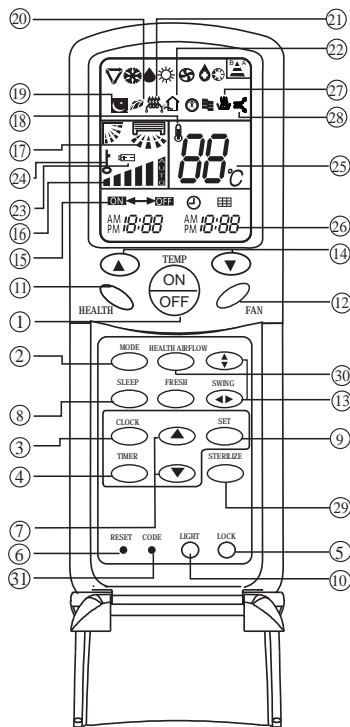

- ① Power ON/OFF
Used for unit start and stop.
- ② MODE
Used to select AUTO run, COOL, DRY, HEAT and FAN operation.
- ③ CLOCK
Used to set correct time.

- ④ TIMER
Used to select
TIMER ON, TIMER
OFF, TIMER
ON/OFF.

- ⑤ LOCK
Used to lock buttons
and LCD display.

- ⑥ RESET
Used to reset the
controller back to
normal condition.

- ⑦ HOUR
Used to set clock and
timer setting.

- ⑧ SLEEP
Used to select sleep
mode

- ⑨ SET
Used to confirm
Timer and Clock
setting.

- ⑩ LIGHT
Control the light up and go out
of the control panel's
background light source and
control the switch of the buzzer.

- ⑪ HEALTH
Used to set Health operation
function

- ⑫ FAN
Used to select fan speed: AUTO,
LOW FAN, MED FAN, HIGH
FAN.

- ⑬ SWING
Used to set UP/DOWN air
sending and RIGHT/LEFT air
sending direction.

- ⑭ TEMP
Used to set temp.,temp.
range:16℃~30℃

- ⑮ Timer ON/OFF display
- ⑯ Fan speed and air sending
direction display

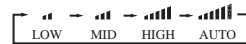

- ⑰ Swing direction display

- ⑱ Room temperature display

- ⑲ Sleep state display

- ⑳ Health display
Display when set Health
operation function.

- ㉑ Electric Heating display

- ㉒ Fresh Air state display

- ㉓ Battery Capacity display
Display when the electric power
of the battery is insufficient.

- ㉔ Lock state display

- ㉕ Temperature display
Used to display the set
temperature

- ㉖ Clock display

- ㉗ Humidifying display

- ㉘ Sterilize display
(This function is optional)

- ㉙ STERILIZE
(This function is optional)

- ⑳ HEALTHAIRFLOW
Used to set healthairflow

- ㉑ CODE A/B selection
For this unit, please set to code A

Note: This model does not have the following related display and function ⑱ ㉑ ㉓ ㉗

■ Operation

Clock set

When unit is started for the first time and after replacing batteries in remote controller, clock should be adjusted as follows:
Press CLOCK button, "AM" or "PM" flashes.

Press ▲ or ▼ to set correct time. Each press will increase or decrease 1 min . If the button is kept pressed, time will change quickly.

After time setting is confirmed, press SET, "AM" and "PM" stop flashing, while clock starts working.

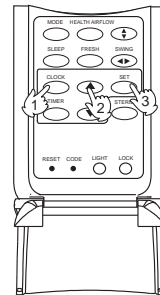

Remote controller's operation

- When in use, put the signal transmission head directly to the receiver hole on the indoor unit
- The distance between the signal transmission head and the receiver hole should be within 7m without any obstacles as well.
- Don't throw the controller, prevent it from being damaged.
- When electronic-started type fluorescent lamp or change-over type fluorescent lamp or wireless telephone is installed in the room, the receiver is apt to be disturbed in receiving the signal so the distance to the indoor unit should be shorter.

Loading of the battery

Slightly press " ▼ " and push down the cover.
Load the batteries as illustrated.
2 R-03 dry batteries, (cylinder)
Be sure that the loading is in line with the "+" / "-" pole request as illustrated.
Put on the cover again.

Confirmation indicator:

In disorderation, reload the batteries or load the new batteries after 5 mins.

Note: The waste batteries should be disposed properly, use two new same-type batteries when loading.

If the remote controller can't function normally or doesn't work at all, use a sharp-pointed item to press the reset key.

Hint: Remove the batteries in case unit won't be in usage for a long period.

If there are any displays after taking-out just need to press reset key.

When throw away the waste batteries, please perform in accordance with the local regulation.

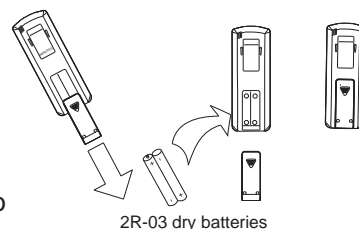

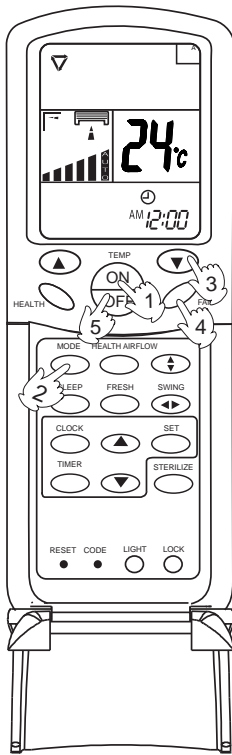

- ① Press ON/OFF button
Unit starts running.
The previous status appears on the display (except. TIMER, SLEEP mode)
- ② Press MODE button. For each press, operation mode changes as follows:

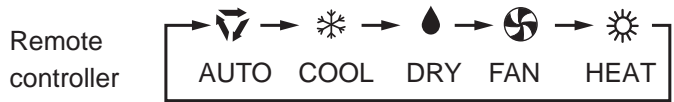

Select Auto run,
" ▾ " appears and auto run starts.

- ③ Select temp. button
Press TEMP button
▲ Every time the button is pressed, temp. setting increases 1°C
▼ Every time the button is pressed, temp. setting decreases 1°C
If the button is kept pressed, setting will increase or decrease quickly.
- ④ Press FAN, For each press, operation mode changes as follows:



Unit runs at the speed displayed on LCD.
When fan speed is AUTO, it is changed automatically according to the indoor temperature.

- ⑤ Press ON/OFF button
Unit stops running.

Note:

During Auto run operation, temp. setting will be shown in LCD display, unit will select heating, cooling or fan operation according to the room temp.

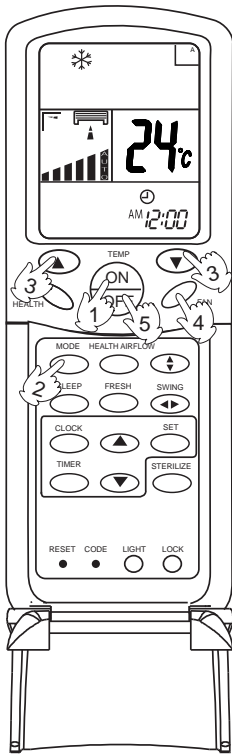

- ① Press ON/OFF button
Unit starts running.
The previous status appears on the display (except. TIMER, SLEEP mode)
- ② Press MODE button. For each press, operation mode changes as follows:

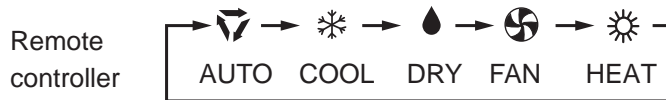

Select cooling operation, Shows "❄️"
Cooling operation starts.

- ③ Select temp. button
Press TEMP button
▲ Every time the button is pressed, temp. setting increases 1°C
▼ Every time the button is pressed, temp. setting decreases 1°C
If the button is kept pressed, setting will increase or decrease quickly.

- ④ Press FAN button. For each press, fan speed changes as follows:



Unit runs at the speed displayed on LCD.
When fan speed is AUTO, it is changed automatically according to the indoor temperature.

- ⑤ Press ON/OFF button
Unit stops running, and when entry this mode for the next time, it will show the previous setting.

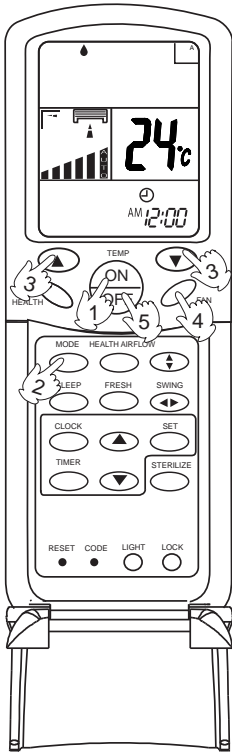

① Press ON/OFF button
Unit starts running.
The previous status appears on the display
(except. TIMER, SLEEP mode)

② Press MODE button. For each press, operation mode changes as follows:

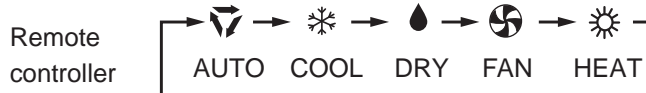

Select Drying operation shows "💧"
Dry operation starts

③ Select temp. button
Press TEMP button
▲ Every time the button is pressed, temp. setting increases 1°C
▼ Every time the button is pressed, temp. setting decreases 1°C
If the button is kept pressed, setting will increase or decrease quickly.

④ Press FAN button. For each press, fan speed changes as follows:



Unit runs at the speed displayed on LCD.

In DRY mode, when room temp. becomes 2°C lower than temp. setting, unit will run intermittently at LOW speed regardless of FAN setting.

⑤ Press ON/OFF button
Unit stops running, and when entering this mode for the next time, it will show the previous setting

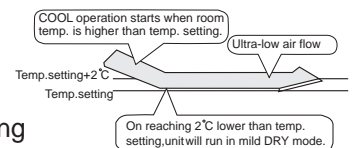

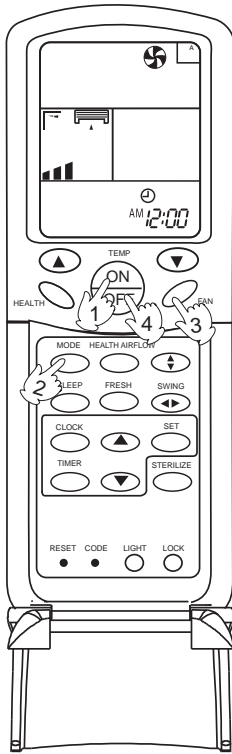

- ① Press ON/OFF button
Unit starts running.
The previous status appears on the display
(except. TIMER, SLEEP mode)
- ② Press MODE button. For each press, operation mode changes as follows:



Select Fan operation shows " ", Fan operation starts.

- ③ Press FAN button. For each press, fan speed changes as follows:



Unit runs at the speed displayed on LCD.

- ④ Press ON/OFF button
Unit stops running, and when entering this mode for the next time, it will show the previous setting.

Note:

In this mode, temp. can't be selected, temp.setting will not be shown in LCD display. In Fan operation mode, "AUTO" fan speed is not available. Operation cycles are as follows:



Note: For cooling only type, this function is invalid.

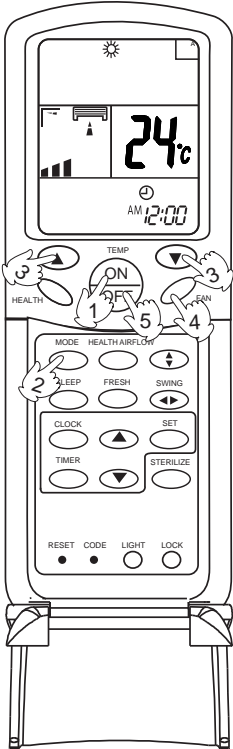

- ① Press ON/OFF button
Unit starts running.
The previous status appears on the display (except. TIMER, SLEEP mode)
- ② Press MODE button. For each press, operation mode changes as follows:



Select Heating operation " ☀ " appears and Heating operation starts.

- ③ Select temp. button
Press TEMP button
▲Every time the button is pressed, temp. setting increases 1°C
▼Every time the button is pressed, temp. setting decreases 1°C
If the button is kept pressed, setting will increase or decrease quickly.
- ④ Press FAN button. For each press, fan speed changes as follows:



In heat mode, warm air will blow out after a short period of time due to cold-draft prevention function.

- ⑤ Press ON/OFF button
Unit stops running, and when entering this mode for the next time, it will show the previous setting.

Swing louvers

(Vertical louvers)

(Horizontal louvers)

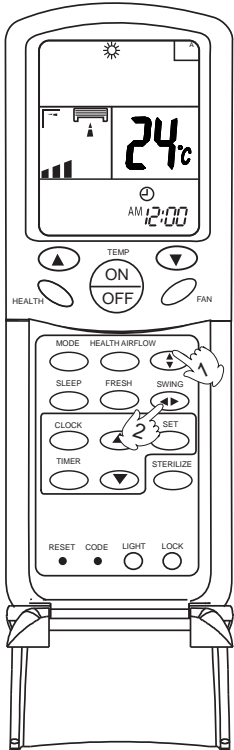

Up and down

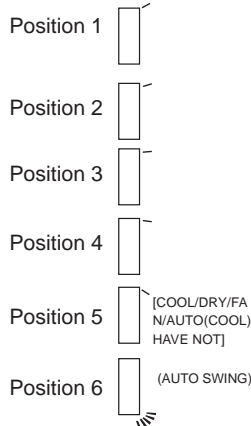

Side from side

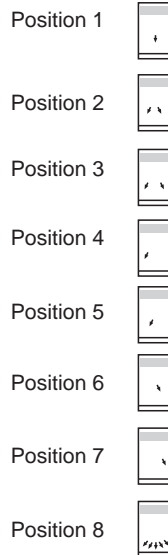

Side from side

Swing

- Press SWING the vertical louvers move from side to side.

Fixed position

- Press the SWING again to fix the vertical louvers at your desired position.

Swing

- Press SWING the horizontal louvers move from up to down.

Fixed position

- Press the SWING

Note: Put louvers at up position in cooling and down position in heating mode. This will be helpful to keep an even room temp.

Notice: In cooling or dry operation, don't put horizontal louvers at downward position for a long time, or outlet grill might get frosted. Don't expose your skin to cool or warm air for a long time.

Remote control unit

Before go to bed, you can press the Sleep button, the air conditioner will operate in comfortable sleep mode to make your sleep more comfortable.

Usage of the Sleep function

After starting, set the Run mode and press the Sleep button.

Run mode

1. In cooling and dry

After starting of the Sleep operation, the temperature will be raised for 1 C° higher than the set temperature 1 hour later, and be raised for 1 C° after another hour. It continues under that condition for 6 hours, then the machine will be switched off. The temperature is higher than the set temperature so as to avoid catching cold in sleeping.

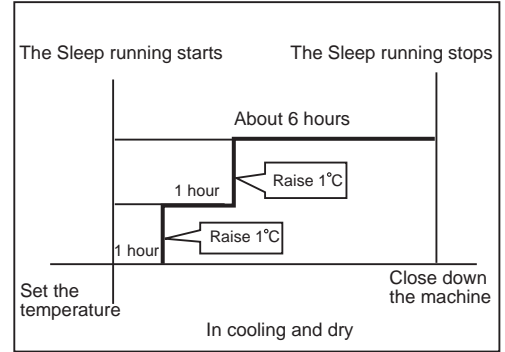

2. In heating (the single-cooling conditioners do not have the function)

After the Sleep running starts, the temperature will drop for 2°C after another one hour. The temperature will raise for 1°C after 3 hours running under the above temperature, and the conditioner will be closed down after running for 3 hours. The temperature is lower than the set temperature so as to avoid uneasiness in sleeping.

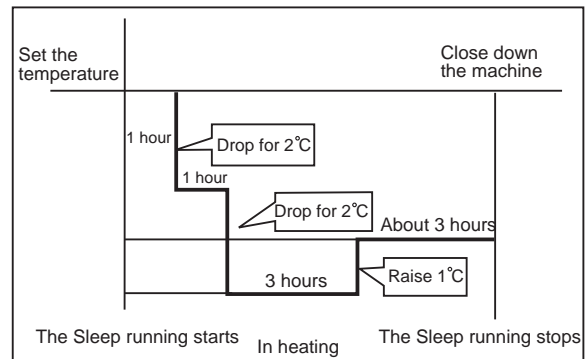
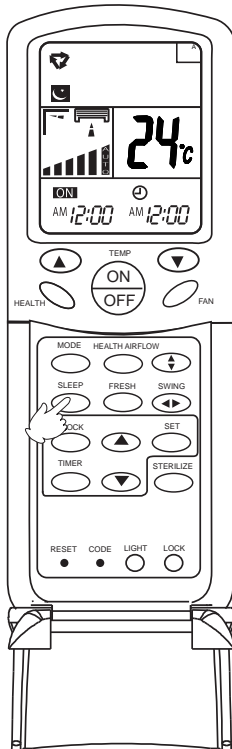

3. In automatic running

The conditioner will run under automatically selected working mode of sleeping.

4. In Fan running

The Sleep function is invalid.

Remote control unit

TIMER operation

Set Clock correctly before starting Timer operation (refer to page 2)

You can let unit start or stop automatically at following times: Before you wake up in the morning, or get back from outside or after you fall asleep at night.

TIMER ON/OFF

(1) After unit start, select your desired operation mode.

Operation mode will be displayed on LCD.

(2) TIMER mode selection

Press TIMER button to change TIMER mode.

Every time the button is pressed, display changes as follows:



Select your desired TIMER mode (TIMER ON or TIMER OFF) ON or OFF will flash.

(3) Timer setting

Press HOUR ▲ / ▼ button.

▲ Every time the button is pressed, time increases 1 min, If button is kept pressed, time will change quickly.

▼ Every time the button is pressed, time decreases 1 min, If button is kept pressed, time will change quickly. Time will be shown on LCD. It can be adjusted within 24 hours.

(4) Confirming your setting

After setting correct time, press SET button to confirm, " ON " or " OFF " stops flashing.

Time displayed: Unit starts or stops at x hour x min (TIMER ON or TIMER OFF)

Timer mode indicator on indoor unit lights up.

To cancel TIMER mode

Just press TIMER button several times until TIMER mode disappears.

Hints

After replacing batteries or a power failure happens, Time setting should be reset.

Remote controller possesses memory function when use TIMER mode next time, just Press SET button after mode selecting if timer setting is the same as previous one.

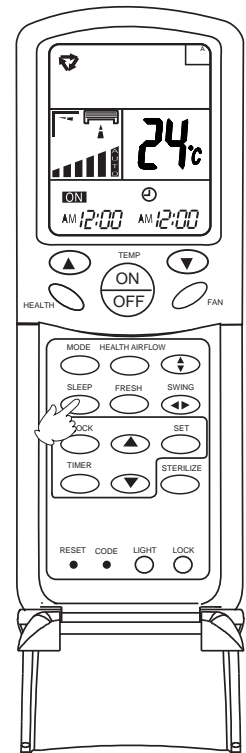

Remote controller operation TIMER ON-OFF

(1) After unit start, select your desired operation mode.

Operation mode will be displayed on LCD.

(2) TIMER mode selection

Press TIMER button to change TIMER mode.

Every time the button is pressed, display changes as follows:



Select your desired TIMER mode (TIMER ON or TIMER OFF) ON or OFF will flash.

(3) Timer setting for TIMER ON

Press HOUR button.

▲ Every time the button is pressed, time increases 1 min. If button is kept pressed, time will change quickly.

▼ Every time the button is pressed, time decreases 1 min. If button is kept pressed, time will change quickly.

Time will be shown on LCD.

It can be adjusted within 24 hours.

AM refers to morning and PM to afternoon.

(4) Time confirming for TIMER ON

After time setting, press TIMER button to confirm, "ON" stops blinking, while "OFF" starts blinking.

(5) Time setting for TIMER OFF

Follow the same procedure in "Time setting for TIMER ON".

(6) Time confirming for TIMER OFF

After time setting, press SET button to confirm, "OFF" stops flashing.

Time displayed: Unit start or stop at x hour x min

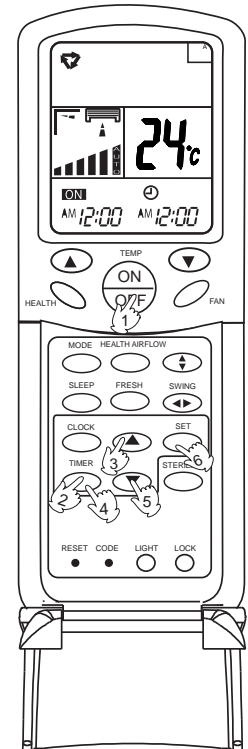

To cancel TIMER mode

Just press TIMER button several times until TIMER mode disappears.

According to the Time setting sequence of TIMER ON or TIMER OFF, either ON-OFF or OFF-ON can be achieved.

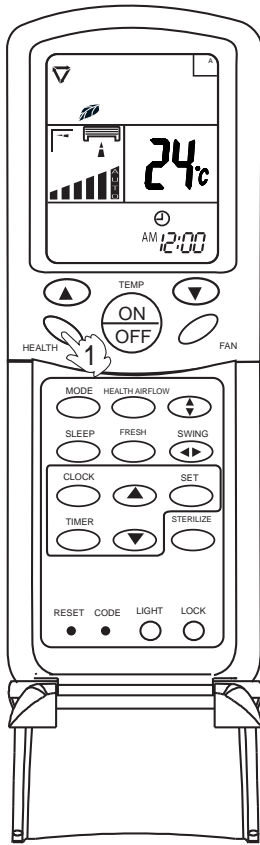

Health operation

After turning on the unit and set the desired working mode. Press the Health button, the LCD will display " 🌿 ", the unit begins health operation (start the negative ion generation device). Press the Health button again, the " 🌿 " displayed on the LCD disappears, health operation is cancelled (turn off the negative ion generation device).

Note: When indoor fan motor does not work, the unit will automatically turn off negative ion generation device.

About Health operation

After the start of Health operation, the negative ion generator will generate large amount of negative ion, which can effectively balance the amount of positive & negative ion in the air and has the bacteria-killing and accelerating the dust deposition of the room to make the room air fresh and healthy.

■ Notes for safety

Clean the dust filter periodically:
Blockage of the dust filter would reduce the cooling and heating effect, consume more power, water would be leaked during cooling, and other failures would also occur.



Use the fuse of required capacity:
Never use steel wire or copper wire to take place of the fuse.

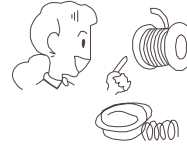

Never connect the earth wire with the gas pipe, water pipe, lightning arrester, or phone line.

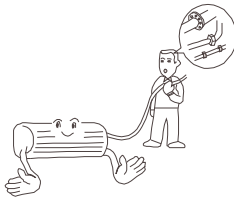

Never install the air conditioner where the flammable gas is easily leaked.



Do not spray any paint or insecticide on the air conditioner.

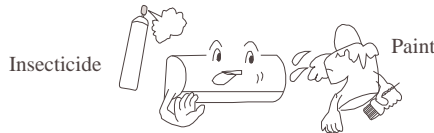

Never pour water on the indoor unit.

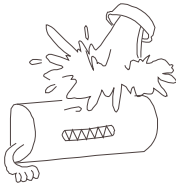

Keep the inlet and outlet of the indoor unit unblocked.

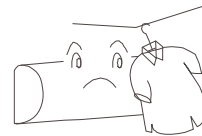

When the louver is being swung, never touch the outlet or put anything into the air grille.

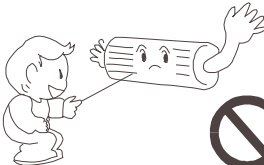

Operate the unit with the remote controller.



The instructions with this warning mark must be carried out strictly, for they are all concerned with safety of the product or human beings.



The instructions with this prohibiting mark must be completely forbidden, otherwise the product would be damaged or the human being would be injured.

■ Operation and Maintenance

Emergency and Test Operation

Emergency operation:

- Use this operation only when the remote controller is defective or lost.
- When the emergency operation switch is pressed "Pi" sound is heard once, which means the start of this operation.
- In this operation, the system automatically selects the operation modes, cooling or heating, according to the room temperature.
- When machine is running in emergency, the set value and wind speed of temperature could not be altered; meanwhile, it can not operate for dehumidifying or under timing mode.

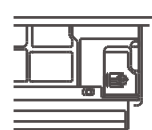

Test operation

Test operation switch is the same as emergency switch.

- Use this switch in the test operation when the room temperature is below 16 °C, do not use it in the normal operation.
- Continue to press the test operation switch for more than 5 seconds, after you hear the "Pi" sound twice, release your finger from the switch: the cooling operation starts with the air flow speed "Hi".

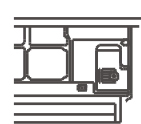

Removal of the restriction of emergency or test operation.

Press the emergency operation switch once more, or manipulate through the remote controller ; the "Pi" sound, the emergency or test operation is stopped.

When the remote controller is manipulated, it gets the system back to the normal operation mode.

Disconnect power supply before clean the unit.

Don't touch it with wet hand.

Don't wash with hot water or solvent to clean the unit.

Air filter and outdoor cleaning



1. Open the inlet grill.
2. Detach the Air filters.
3. Use water or vacuum cleaner to clean it. If it is extremely dirty, wash it with neutral detergent or soap water.
4. Wash it with clean water and install it after complete dry.
5. Close the inlet grill.

Caution:

- Do not use hot water over 40°C, as this may cause damage to air filter.
- Wipe air filter carefully.
- Clean it with warm and wet cloth or with neutral detergent, then wipe it dry with clean and soft cloth.
- If air conditioner is very dirty, clean it with cloth soaked in neutral detergent, then wipe off the detergent with clean water.
- Don't use insecticide or other chemical detergents.

■ Trouble shooting

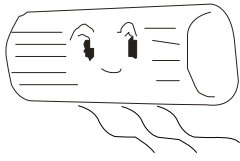
The followings are not malfunction

<p>Water flowing sound is heard</p> 	<p>When the air conditioner is started, when the compressor starts or stops during operation or when the air conditioner is stopped, it sometimes sounds “ Bi- Bi-” or “Godo-Godo”. It is the flowing sound of the refrigerant , not a malfunction.</p>
<p>Cracking sound is heard</p>	<p>This is caused by heat expansion or contraction of plastics</p>
<p>It smells.</p>	<p>Air blown out from the indoor unit sometimes smells. The smell results from smells of furniture, paint , tobacco absorbed by indoor unit.</p>
<p>During operation, white fog comes out of indoor unit.</p> 	<p>When in COOL or DRY mode, a thin water fog can be seen blown out of unit ,this is the condensed fog because the suddenly cooled indoor air is blown out.</p>
<p>Automatically switch into FAN mode during cooling.</p>	<p>To prevent frost from being accumulated on the indoor unit heat exchanger, it sometimes automatically switched into the FAN mode, but it will soon back to the cooling mode.</p>
<p>The air conditioner cannot be restarted soon after it stops. Air conditioner does not start?</p> 	<p>This is because of the self-protection function of the system, therefore, it cannot be restarted for about three minutes after it stops. Please wait for three minutes</p>

■ Trouble shooting

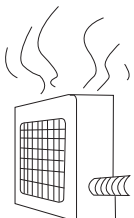
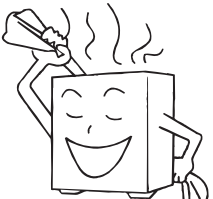
<p>Air does not blow or the fan speed cannot be changed during drying.</p>	<p>In DRY mode, when room temperature becomes 2 °C higher than temperature setting, unit will run intermittently at LO speed regardless of FAN setting</p>
<p>Water or vapor generated from the outdoor unit during heating.</p> 	<p>This happens when the frost accumulated on the outdoor unit is removed (during defrosting operation).</p> <p>Defrosting operation</p> 
<p>During heating, indoor fan is still running even unit is stopped.</p>	<p>To get ride of the excess heat, indoor fan will continue running for a while after unit automatically stops.</p>

Please check the following things about your air conditioner before making a service call.

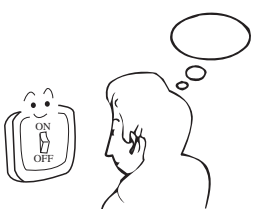
Unit fails to start.		
<p>Is the power supply switch on ?</p>  <p>Power supply switch is not in ON position.</p>	<p>Is city supply power normal ?</p> 	<p>Is the earth leakage breaker in action ?</p> <p>Be sure to turn off the power supply switch immediately and contact the sales dealer.</p>

Customer Need-to-know

Customer Need-to-know



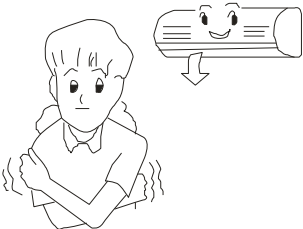
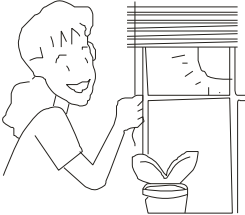
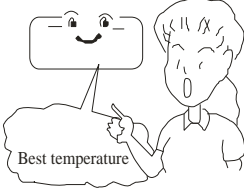
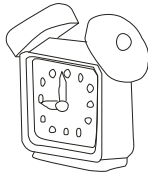

- Please install the air conditioner according to the requirements specified in this manual to ensure the air conditioner work well.
- Be careful not to scratch the surface of the case during moving the air conditioner.
- Please keep the installation manual for future reference when maintenance and changing installation place.
- After installation ,please use the air conditioner according to the specification in the operation manual.

Using Directions	
<p>Adjust suitable airflow direction</p> 	<p>Avoid direct sunlight and airflow</p> 
<p>Keep the proper indoor temperature. Too cool or hot is not good for your health. Furthermore,it will result in excessive consumption of electric power.</p> 	<p>Effectively use timer. Using TIMER mode, you can make the room temperature reach a suitable temperature when you wake up or go back home.</p> 

ATTENTION: After finishing installation, please confirm there is no refrigerant leakage.

■ Instructions to installation

1. Safety precautions

- Please read these "Safety Precautions" first then accurately execute the installation work.
 - Though the precautionary points indicated herein are divided under two headings,  WARNING and , those points which are related to the strong possibility of an installation done in error resulting in death or serious injury are listed in the  CAUTION section. However, there is also a possibility of serious consequences in relationship to the points listed
 - in the  CAUTION section as well.
- In either case, important safety related information is indicated, so by all means, properly observe all that is mentioned.

WARNING

- This system should be applied to places as office, restaurant, residence and the like. Application to inferior environment such as engineering shop could cause equipment malfunction.
- Please entrust installation to either the company which sold you the equipment or to a professional contractor. Defects from improper installations can be the cause of water leakage, electric shocks and fires.
- Execute the installation accurately, based on following the installation manual. Again, improper installations can result in water leakage, electric shocks and fires.
- When a large air-conditioning system is installed to a small room, it is necessary to have a prior planned countermeasure for the rare case of a refrigerant leakage, to prevent the exceeding of threshold concentration. In regards to preparing this countermeasure, consult with the company from which you purchased the equipment, and make the installation accordingly. In the rare event that a refrigerant leakage and exceeding of threshold concentration does occur, there is the danger of a resultant oxygen deficiency accident.
- For installation, confirm that the installation site can sufficiently support heavy weight. When strength is insufficient, injury can result from a falling of the unit.
- Execute the prescribed installation construction to prepare for earthquakes and the strong winds of typhoons and hurricanes, etc. Improper installations can result in accidents due to a violent falling over of the unit.
- For electrical work, please see that a licensed electrician executes the work while following the safety standards related to electrical equipment, and local regulations as well as the installation instructions, and that only exclusive use circuits are used.
Insufficient power source circuit capacity and defective installation execution can be the cause of electric shocks and fires.
- Accurately connect wiring using the proper cable, and insure that the external force of the cable is not conducted to the terminal connection part, through properly securing it. Improper connection or securing can result in heat generation or fire.
- Take care that wiring does not rise upward, and accurately install the lid/service panel. Its improper installation can also result in heat generation or fire.
- When setting up or moving the location of the air conditioner, do not mix air etc. or anything other than the designated refrigerant within the refrigeration cycle.
Rupture and injury caused by abnormal high pressure can result from such mixing.
- Always use accessory parts and authorized parts for installation construction. Using parts not authorized by this company can result in water leakage, electric shock, fire and refrigerant leakage.

CAUTION

- Execute proper grounding. Do not connect the ground wire to a gas pipe, water pipe, lightning rod or a telephone ground wire. Improper placement of ground wires can result in electric shock.
- The installation of an earth leakage breaker is necessary depending on the established location of the unit. Not installing an earth leakage breaker may result in electric shock.
- Do not install the unit where there is a concern about leakage of combustible gas.
The rare event of leaked gas collecting around the unit could result in an outbreak of fire.
- For the drain pipe, follow the installation manual to insure that it allows proper drainage and thermally insulate it to prevent condensation. Inadequate plumbing can result in water leakage and water damage to interior items.

■ Instructions to installation

PRECAUTION

- Execute proper grounding. Do not connect the earth wire to a gas pipe, water pipe, lightning rod, or a telephone ground wire. Improper placement of earth wires can result in electric shock.
- An electric leakage breaker must be installed, otherwise electric shock or other accidents would occur.
- After completion of the installation, the air conditioner shall be electrified to check for electric leakage.

2. Preparation for installation

Installation tools

1	Screw Driver (flat head, wabblers, triangle)	8	Pipe Expander
2	Steel Saw	9	Knives
3	60mm Drill	10	Clippers
4	Inner Hexagon Spanner	11	Leakage Checker or Soap Liquid
5	Shifting Spanner	12	Measuring Tape
6	Spanner	13	Scraper or File
7	Pipe Cutter	14	Refrigeration Oil

3. Accessories for installation

Self-contained accessories

No.	A	B	C	D	E	F
Name of Parts	Non-adhesive Tape	Adhesive tape	Connecting Hose	Heat insulation material	Gypsum powder	Drain hose

4. Choose the installation place

- Install the indoor unit where the weight of the unit can be supported.
- Install the indoor unit where the heat source and steam source are not close and the unit inlet and outlet are not blocked.
- Install the indoor unit where the drainage is easy and the outdoor unit can be easily connected.
- Install the indoor unit where its cold air and hot air can be easily sent to all the comers of the room.
- Install the indoor unit where the power socket is near and there is sufficient space around the indoor unit.
- Install the indoor unit where there is no T.V set, radio set, and wireless appliance underneath, and the sunlight lamp is over one meter away.
- If the remote controller is installed on the wall, the indoor unit shall be ensured to receive the signal while the sunlight lamp is on.

Instructions to installation

5. Method for Cutting and Expanding Pipes.

When the pipe is too long or the mouth is damaged, the pipe needs to cut or expanded.

1. cutting hose



2. Removing burr



3. Put on nut



4. Expand Hose

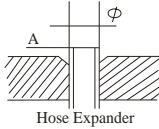

Expansion Size

Hose dia. Φ	Size (mm)A
6.35 mm(1/4)	0.8-1.5
9.52 mm(3/8)	1.0-1.5

Correct	Not Correct					
	Tilting	cracks on expanded mouth	burr	incomplete	too long	

6. When the mounting plate is first fixed

1. Carry out, based on the neighboring pillars or lintels, a proper leveling for the plate to be fixed against the wall, then temporarily fasten the plate with one steel nail.
2. Make sure once more the proper level of the plate, by hanging a thread with a weight from the central top of the plate, then fasten securely the plate with the attachment steel nail.

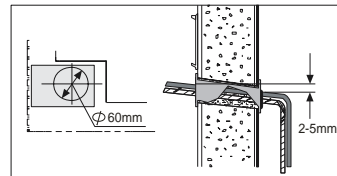
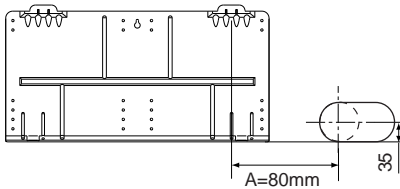

3. Making a Hole on the wall and Fitting the piping Hole cover.

- Make a hole of 60mm in diameter, slightly descending to outside the wall.
- Install piping hole cover and seal it off with putty after installation.

4. Drawing of pipe Rear piping

Draw pipes and the drain hose, then fasten them with the adhesive tape. Left Left-rear, piping.

- In case of left side piping, cut away, with a nipper, the lid for left piping.
- In case of left-rear piping, bend the pipes according to the piping direction to the mark of hole for left-rear piping which is marked on heat insulation materials.

(1) Insert the drain hose into the dent of heat insulation materials of indoor unit.

(2) Insert the indoor/outdoor electric cord from backside of indoor unit, and pull it out on the front side, then connect them.

(3) Coat the flaring seal face with refrigerant oil and connect pipes.

Cover the connection part with heat insulation materials closely, and make sure fixing with adhesive tape.

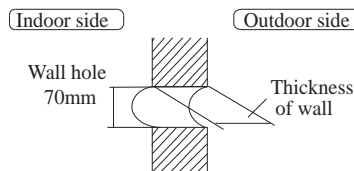

(Section of wall hole) Piping hole pipe

■ Instructions to installation

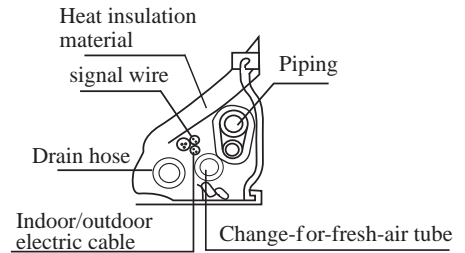
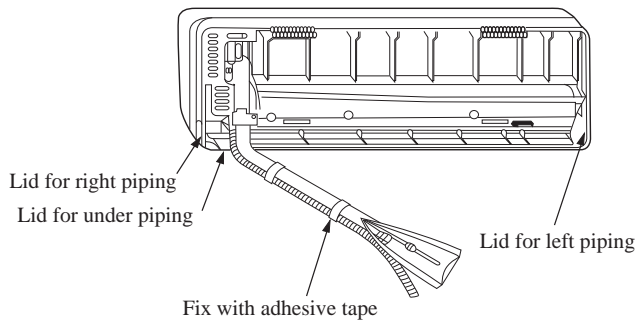

Indoor/outdoor electric cord and drain hose must be bound with refrigerant piping by protecting tape

7. Other direction piping

- Cut away, with a nipper, the lid for piping according to the piping direction and then bend the pipe according to the position of wall hole. When bending, be careful not to crash pipes.
- Connect beforehand the indoor/outdoor electric cable, and then pull out the connected to the heat insulation of connecting part specially.
- Hang surely the unit body onto the upper notches of the mounting plate. Move the body from side to verify its secure fixing.
- In order to fix the body onto the mounting plate, hold up the body aslant from the underside and then put it down perpendicularly.

8. Indoor unit communication addresses setting

CAUTION! FAIL TO DO THIS, THE UNIT WILL NOT WORK.

1. There are two methods to set the communication address

- A. Use the remote controller (default status in first installation).
- B. Use dip switches on the indoor unit PCB.

2. Address setting procedure when using the remote controller.

- A. Set the addresses only after the successful installation of the refrigerant pipes and connecting cables, and open all the stop valves;
- B. Please confirm that the indoor units and the outdoor unit in the same system use the same power source;
- C. Power on the units, but put all the indoor units in the status of STANDBY;
- D. Please note that the address must be set as following:
Indoor unit that connect to valve A, the address must be 1;
Indoor unit that connect to valve B, the address must be 2;
Indoor unit that connect to valve C, the address must be 3;
- E. Example: set unit A to address 1.

Continuously press the emergency switch for about 15 seconds, the buzzer will sound 4 times (PI PI PI PI) and then leave go of the switch. At this time, the indoor unit has entered the address setting procedure. But the LED board is blank.

F. Use the controller to turn on the indoor unit. At this time, the controller should be changed from OFF to ON, and then the TIMER LED flashes once. That is to say, the address setting is enabled.

G. Press the button "SLEEP" on the controller, the times you press it stands for the address you want to set, detailed as following:

Press button "SLEEP" once, the address is "1", and the TIMER LED flashes once;

Press button "SLEEP" twice, the address is "2", and the TIMER LED flashes twice;

Press button "SLEEP" three times, the address is "3", and the TIMER LED flashes three times;

H. Use the remote controller to turn off the unit. At this time, the controller should be changed from ON to OFF, and the unit will exit the address setting procedure, the address will be memorized. The LED board will always display the address of this indoor unit until the system be powered off.

■ Instructions to installation

- I. If you want to change the address, please repeat the above steps from E to G.
 J. After setting all the addresses, please power off the system and then power on again. Otherwise the system will not start to work.
 K. Once the addresses are successfully set, please do not change it any more to avoid confusion.
 3. Address setting procedure when using the DIP switches SW01 and SW02.
 A. The DIP switches SW01 and SW02 are on the indoor unit PCB.
 B. Before carrying out the address setting work, the system must be powered off.
 C. Take off the front panel and the filters, then take off the flaps and also the front cover, disconnect the swing motor connectors from the PCB and then take out the lower part of the PCB.
 D. Change the position of DIP 1 of SW01 from OFF to ON, if fail to do this, the addresses set by SW02 will not work.
 E. Use SW02 to set the addresses as following(DO NOT CHANGE OTHER DIP SWITCHES):

SW01								SW02								INDOOR UNIT ADDRESS	
1	2	3	4	5	6	7	8	1	2	3	4	5	6	7	8	ON	
■																OFF	1
																ON	
																OFF	2
																ON	
																OFF	3

4. How to check the addresses?
 When finish all the above works, please power off and power on again to the whole system but set all the indoor units in STANDBY. Then continuously press the emergency switch until you hear the buzzer sound 5 times(Pi Pi Pi Pi Pi), and then the LED board will show the address of this indoor unit. Press any key on the remote controller, it will exit the address checking procedure.

8.Installation check and trial operation

Check the Layout of the Drain Pipe and Connection Wires, and also the piping and address setting. The drain pipe should be placed underneath, and the connection wires should be placed upside; and the drain pipe especially the section inside the machine and indoors must be wound up with insulating material to preserve heat. The drain pipe shall be sloped and no concave and convex shall occur along the whole pipe. And the cases as the right figure indicates shall not occur.

9.Installation check

- Is power supply voltage required?
- Is water completely drained to outdoors?
- Are power wire and connection wires between indoor and outdoor units correctly connected?
- Is any gas leaked from the pipe connectors?
- Are series numbers of the terminals on the indoor and outdoor units corresponding to each other?
 Is the connection section of the auxiliary pipe insulated? Is the indoor unit fixed firmly?
- Is noise big?

10.Trial operation





- The person who has completed this installation shall be requested to conduct a test operation for check:
- Is the temperature adjuster working normally?
 - Does the location for installation conform to requirements?

Winding up with Protective Plastic Tape.The connection pipes,drain pipe, and the connection wires shall be wound up with PVC tape.

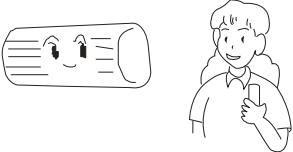

Notes: The connection pipes shall also be wound up with insulating material to preserve the temperature. The airing direction shall be from bottom to top.

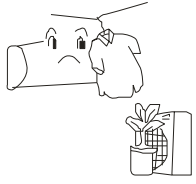
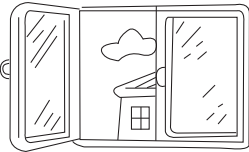
■ When trouble happens

Insufficient cooling or heating

<p>The operation controller adjusted as required</p> 	<p>Air filter too dirty ?</p> 	<p>Horizontal swing louver upward ? (in HEAT mode)</p> 
<p>Any obstacle exists at the air inlet or outlet?</p> 	<p>Door or window left opened ?</p> 	

Insufficient cooling

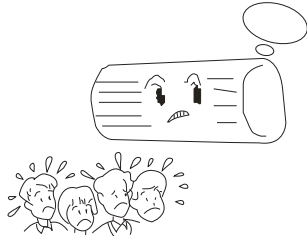
<p>Any other heat sources in the room?</p> 	<p>Sunlight direct into the room ?</p> 	<p>Too crowded in the room ?</p> 
--	--	---

Cooled air blown out (when heating)

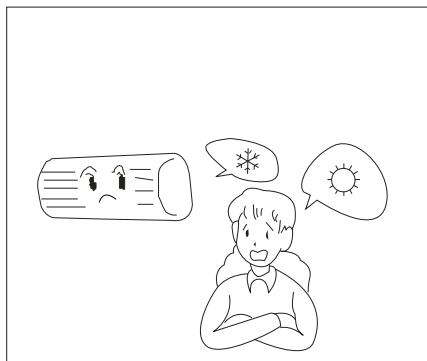

When the air conditioner does not operate properly after you have checked the above-mentioned items or when following phenomenon is observed, stop the operation of the air conditioner and contact your sales dealer.

- 1) The fuse or breaker often shuts down.
- 2) Water drops off during cooling or drying operation.
- 3) There is an irregularity in operation or abnormal sound that is audible.

■ Failure code

TROUBLE SHOOTING	FAILURE CODE (TIMER LED OF INDOOR RECEIVER BOARD FLASHES TIMES)	POSSIBLE REASONS
Faulty temperature sensor Tai	ONCE *	Sensor disconnected, or broken, or at wrong position, or short circuit
Faulty temperature sensor Tc1	TWICE *	Sensor disconnected, or broken, or at wrong position, or short circuit
Faulty temperature sensor Tc2	3 TIMES *	Sensor disconnected, or broken, or at wrong position, or short circuit
Faulty temperature sensor Tm	4 TIMES *	Sensor disconnected, or broken, or at wrong position, or short circuit
Faulty EEPROM on indoor unit PCB	5 TIMES	Faulty indoor unit PCB
Abnormal communication between indoor and outdoor unit	6 TIMES *	Wrong connection, or the wires be disconnected, or wrong address setting of indoor units, or faulty PCB, or faulty power supply
Indoor unit address repeated	9 TIMES	Wrong setting of indoor unit address
Central control address repeated	10 TIMES	Wrong setting of centralized control indoor unit address
Faulty indoor unit fan motor	11 TIMES	Fan is blocked, or the terminal is disconnected from the PCB, or faulty indoor unit PCB
Faulty driver of indoor unit fan motor	12 TIMES	Faulty indoor unit PCB
Malfunction on outdoor unit	20 TIMES	Check the outdoor unit

Note:

1. Please contact the installers or distributors when trouble happens to repair it.
2. Turn the power off and power on again, if the failure code recurs, please change the indoor unit PCB.
3. Failure codes marked with * are resumable.

HAIER GROUP

Qingdao Haier Air Conditioner Electric Co., Ltd.

Address: Haier Garden, Qianwangang Road, Economic Development Zone,
Qingdao, Shandong 266500, P.R.China

Web Site: <http://www.haier.com>