

# CABINET TYPE AIR CONDITIONER

## Operation & Installation Manual



AP482AKEAA  
AP602AKEAA

No.0010578212

- Please read this operation manual before using the air conditioner.
- Please keep this manual carefully and safely.

# ■ Content

---

## Operation

Cautions .....	1-2
Parts .....	3-4
Operation .....	5-12
Operation hints .....	13
Energy saving .....	14
Maintenance .....	15-16
Trouble shooting .....	17
When problems occur .....	18-19
Indoor & outdoor unit connection .....	20
Tools necessary .....	21
Installation procedures .....	22-26
Others .....	27

# ■ Cautions

## *Disposal of the old air conditioner*

Before disposing an old air conditioner that goes out of use, please make sure it's inoperative and safe. Unplug the air conditioner in order to avoid the risk of child entrapment.

It must be noticed that air conditioner system contains refrigerants, which require specialized waste disposal. The valuable materials contained in a air conditioner can be recycled. Contact your local waste disposal center for proper disposal of an old air conditioner and contact your local authority or your dealer if you have any question. Please ensure that the pipework of your air conditioner does not get damaged prior to being picked up by the relevant waste disposal center, and contribute to environmental awareness by insisting on an appropriate, anti-pollution method of disposal.

## *Disposal of the packaging of your new air conditioner*

All the packaging materials employed in the package of your new air conditioner may be disposed without any danger to the environment.

The cardboard box may be broken or cut into smaller pieces and given to a waste paper disposal service. The wrapping bag made of polyethylene and the polyethylene foam pads contain no fluorochloric hydrocarbon.

All these valuable materials may be taken to a waste collecting center and used again after adequate recycling.

Consult your local authorities for the name and address of the waste materials collecting centers and waste paper disposal services nearest to your house.

## *Safety Instructions and Warnings*

Before starting the air conditioner, read the information given in the User's Guide carefully. The User's Guide contains very important observations relating to the assembly, operation and maintenance of the air conditioner.

The manufacturer does not accept responsibility for any damages that may arise due to non-observation of the following instruction.

- Damaged air conditioners are not to be put into operation. In case of doubt, consult your supplier.
- Use of the air conditioner is to be carried out in strict compliance with the relative instructions set forth in the User's Guide.
- Installation shall be done by professional people, don't install unit by yourself.
- For the purpose of safety, the air conditioner must be properly grounded in accordance with specifications.
- Always remember to unplug the air conditioner before opening inlet grill. Never unplug your air conditioner by pulling on the power cord. Always grip plug firmly and pull straight out from the outlet.

# ■ Cautions

- All electrical repairs must be carried out by qualified electricians. Inadequate repairs may result in a major source of danger for the user of the air conditioner.
- Do not damage any parts of the air conditioner that carry refrigerant by piercing or perforating the air conditioner's tubes with sharp or pointed items, crushing or twisting any tubes, or scraping the coatings off the surfaces. If the refrigerant spurts out and gets into eyes, it may result in serious eye injuries.
- Do not obstruct or cover the ventilation grille of the air conditioner. Do not put fingers or any other things into the inlet/outlet and swing louver.
- Do not allow children to play with the air conditioner. In no case should children be allowed to sit on the outdoor unit.

## *Specifications*

- The refrigerating circuit is leak-proof.

The machine is adaptive in following situation

1. applicable ambient temperature range:

			Rated	Maximum	Minimum
Cooling	Indoor	DB °C	27	32	18
		WB °C	19	23	14
	outdoor	DB °C	35	43	10
		WB °C	24	26	6
Heating	Indoor	DB °C	20	27	15
		WB °C	14.5	--	--
	outdoor	DB °C	7	24	-7
		WB °C	6	18	--

2. If the supply cord is damaged, it must be replaced by the manufacturer or its service agent or a similar qualified person.

3. If the fuse on PC board is broken please change it with the type of T 3.15A /250VAC.

Please check the circuit diagram about the fuse replaced.

4. The wiring method should be in line with the local wiring standard.

5. The power cable and connecting cable are self-provided. All the cables shall have got the local authentication certificate.

6. The breaker of the air conditioner should be all-pole switch; and the distance between its two contacts should be no less 3mm. Such means for disconnection must be incorporation in the fixed wiring.

7. The waste battery shall be disposed properly.

# Parts

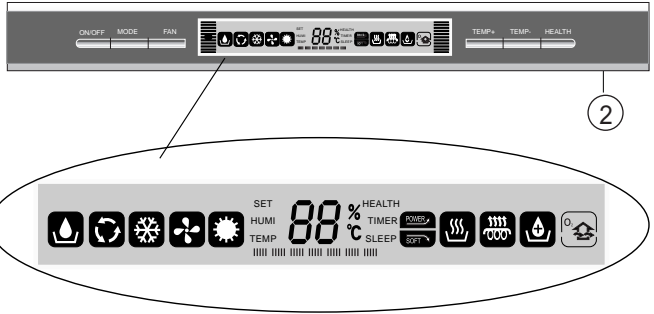
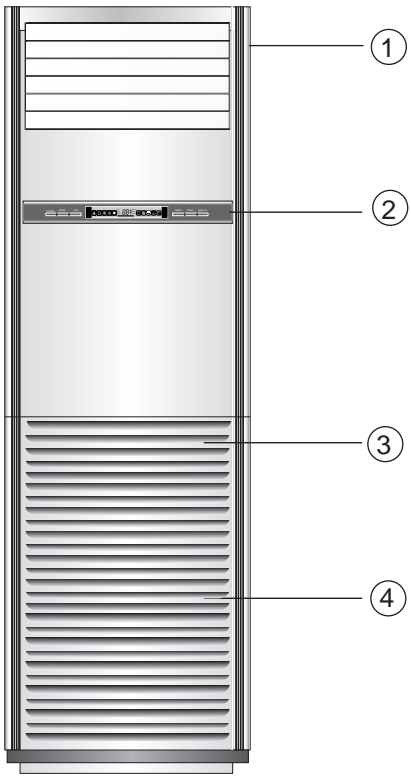

## Indoor unit

- ① Outlet grill
- ② Operation panel
- ③ Inlet grill
- ④ Air filter [inside the unit]

## Remote controller

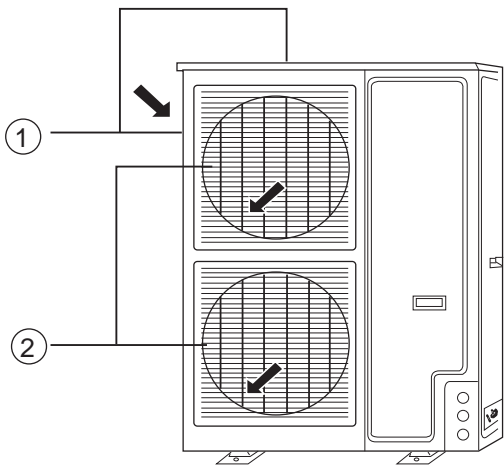

## Outdoor unit

- ① Inlet grill
- ② Outlet grill

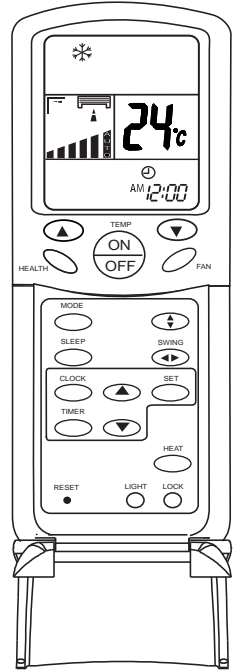

# Parts

## Manual Operation

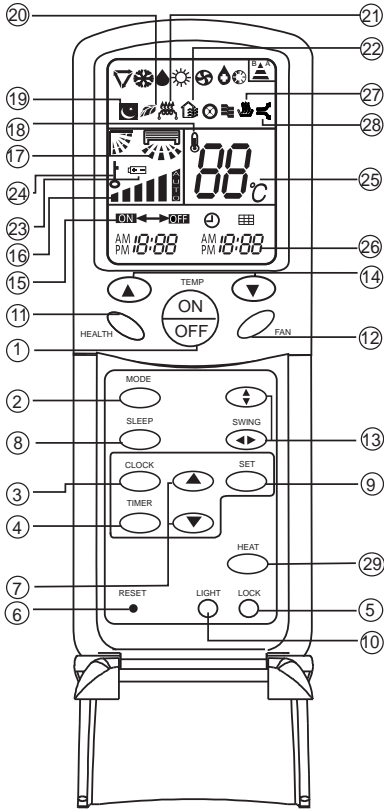

- ① Power ON/OFF  
Used for unit start and stop.
- ② MODE  
Used to select AUTO run, COOL, DRY, FAN and HEAT operation.
- ③ CLOCK  
Used to set correct time.

- ④ TIMER  
Used to select TIMER ON, TIMER OFF, TIMER ON/OFF.
- ⑤ LOCK  
Used to lock buttons and LCD display.

- ⑥ RESET  
Used to reset the controller back to normal condition.

- ⑦ HOUR  
Used to set clock and timer setting.

- ⑧ SLEEP  
Used to select sleep mode

- ⑨ SET  
Used to confirm Timer and Clock setting.

- ⑩ LIGHT  
Control the light up and go out of the control panel's background light source and control the switch of the buzzer.

- ⑪ HEALTH  
Used to set Health operation function

- ⑫ FAN  
Used to select fan speed: AUTO, LOW FAN, MED FAN, HIGH FAN.

- ⑬ SWING  
Used to set UP/DOWN air sending and RIGHT/LEFT air sending direction.

- ⑭ TEMP  
Used to set temp., temp. range:16°C~30°C

- ⑮ Timer ON/OFF display

- ⑯ Fan speed and air sending direction display

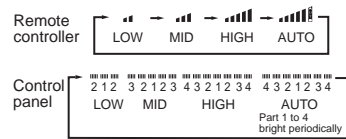

- ⑰ Swing direction display

- ⑱ Room temperature display

- ⑲ Sleep state display

- ⑳ Health display  
Display when set Health operation function.

- ㉑ Electric Heating display

- ㉒ Fresh Air state display

- ㉓ Battery Capacity display

- Display when the electric power of the battery is insufficient.

- ㉔ Lock state display

- ㉕ Temperature display  
Used to display the set temperature and room temperature.

- ㉖ Clock display

- ㉗ Humidifying display

- ㉘ Power/Soft operation display

- ㉙ HEAT  
Select Auxiliary electric heater

Note: These models don't have the following related display and function ㉒ ㉗ ㉘  
 For some air conditioners , the function ⑪ ㉙ is not availed.  
 For cooling only unit, there is no functions related to heat.

# ■ Operation

## Clock set

When unit is started for the first time and after replacing batteries in remote controller, clock should be adjusted as follows:

- ① Press CLOCK button, "AM" or "PM" flashes.
- ② Press ▲ or ▼ to set correct time. Each press will increase or decrease 1 min. If the button is kept pressed, time will change quickly.
- ③ After time setting is confirmed, press SET, "AM" and "PM" stop flashing, while clock starts working.

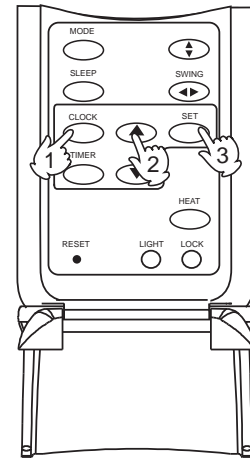

## Remote controller's operation

- When in use, put the signal transmission head directly to the receiver hole on the indoor unit
- The distance between the signal transmission head and the receiver hole should be within 7m without any obstacles as well.
- Don't throw the controller, prevent it from being damaged.
- When electronic-started type fluorescent lamp or change-over type fluorescent lamp or wireless telephone is installed in the room, the receiver is apt to be disturbed in receiving the signal so the distance to the indoor unit should be shorter.

## Loading of the battery

Slightly press "▼" and push down the cover.

Load the batteries as illustrated.

2 R-03 dry batteries, (cylinder)

Be sure that the loading is in line with the "+" / "-" pole request as illustrated.

Put on the cover again.

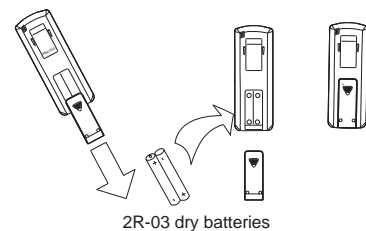

## Confirmation indicator:

In disorderation, reload the batteries or load the new batteries after 5 mins.

Note: The waste batteries should be disposed properly, use two new same-type batteries when loading.

If the remote controller can't function normally or doesn't work at all, use a sharp-pointed item to press the reset key.

Hint: Remove the batteries in case unit won't be in usage for a long period.

If there are any displays after taking-out just need to press reset key.

When throw away the waste batteries, please perform in accordance with the local regulation.

# ■ Operation

## Control panel



## Remote-control unit

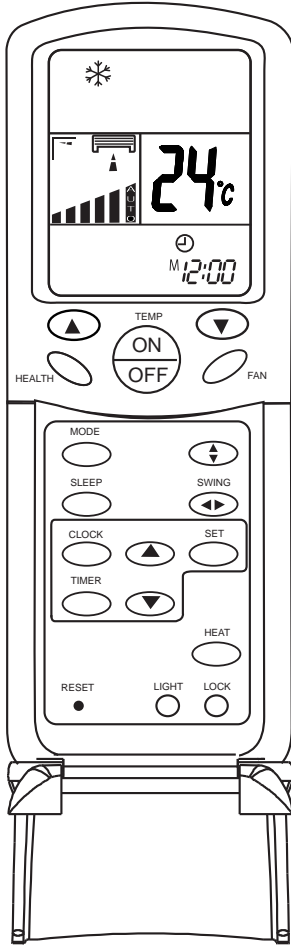

- ① Press ON/OFF button

Unit starts running.

The previous status appears on the display (except. TIMER, SLEEP mode)

- ② Press MODE button. For each press, operation mode changes as follows:

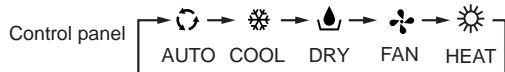

Then select AUTO run or select COOL operation or select DRY operation or select HEAT operation\*

- ③ Select temp. button

Press TEMP button

TEMP+ ▲ Every time the button is pressed, temp. setting increases 1°C

TEMP- ▼ Every time the button is pressed, temp. setting decreases 1°C

If the button is kept pressed, setting will increase or decrease quickly.

- ④ Press FAN, For each press, operation mode changes as follows:

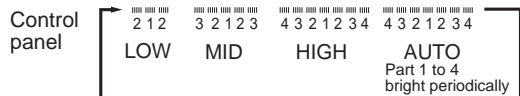

Unit runs at the speed displayed on LCD.

When fan speed is AUTO, it is changed automatically according to the indoor temperature.

- ⑤ Press ON/OFF button Unit stops running.

In DRY mode, when room temp. becomes 2 °C higher than temp. setting, unit will run intermittently at LOW speed regardless of FAN setting.

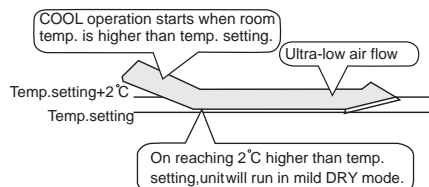

### Note:

During Auto run operation, temp. setting will be shown in LCD display, unit will select heating, cooling or fan operation according to the room temp.



### Manual Operation

#### Control panel



#### Remote controller

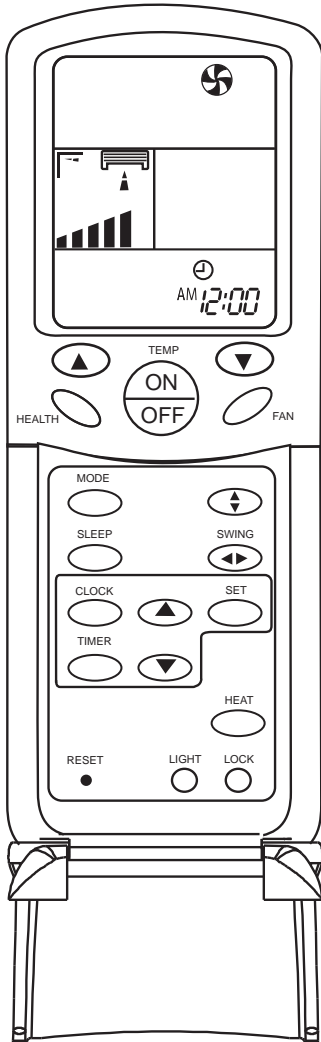

#### 1. Unit start

Press ON/OFF button to start your air conditioner.

Previous operation status appears on LCD (except for TIMER, SLEEP, setting).

#### 2. Select operating mode

Press MODE button. At each press, operation mode changes as follows:

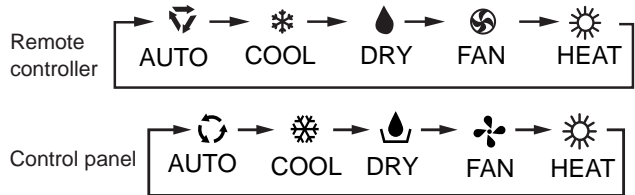

Then select FAN

#### 3. Adjust fan speed

Press FAN button. At each press, fan speed changes as follows:



Air conditioner will run at the selected fan speed.

#### 4. Unit stop

Press ON/OFF button to stop unit.

#### About FAN mode

When the air conditioner runs in FAN mode, it is not possible to select AUTO FAN or to set temperature.

### Swing louvers (Vertical louvers) (Horizontal louvers)

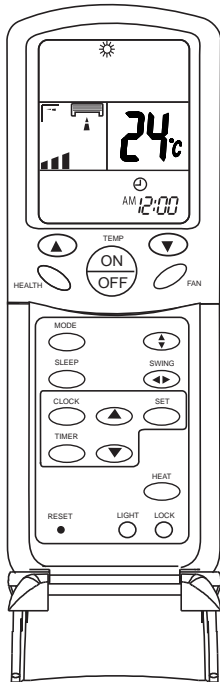

#### Up and down

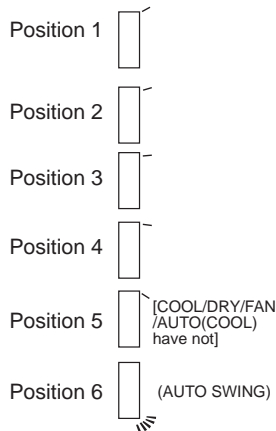

#### Side from side

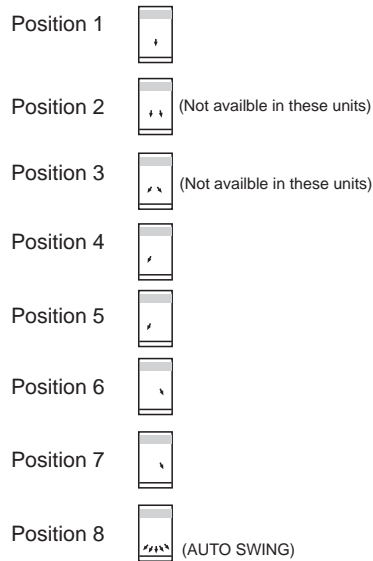

## 2.Up & down air direction

Press the up & down button once ,the LCD airflow direction will display as follows:

Cooling/Dehumidification/airflow :

Remote controller: →Position 1 → Position 2 → Position 3 → Position 4 → Position 6 →

Heating : →Position 5 → Position 4 → Position 3 → Position 2 → Position 1 → Position 6 →

Auto : →Position 1 → Position 2 → Position 3 → Position 4 → Position 5 → Position 6 →

The up& down flade will move according to the above conditions.

Note:Pay more attention to not cut down the power supply because the flade can't back to the colse position at this circumstance;

## 3.Left & right air direction

Press the Left & right button once ,the LCD airflow direction will display as follows:

Remote controller: →Position 1 → Position 2 → Position 3 → Position 4 → Position 5 → Position 6 → Position 7 → Position 8 →

The left & right flade will move according to the above conditions.

Note:

- 1.During AUTO mode,pls. don't touch the flade to avoid damaging the inner part of the unit;
- 2.If the difference between real position & the chart position ,press ON/OFF(control panel) button or ON/OFF (remote controller ) button to close the flade and re-open the unit,then it will be normal condition.

## Control panel



## Use of SLEEP function

Before using this function, the clock must be set.

After the unit's start, set running mode and then press SLEEP button once to make the air conditioner have the previous-set sleep time (first power-on is "1h"). The sleep symbol will appear. Press time button ▲/▼ : you can choose the time in 1~8 hours. Each time the button is pressed, the time increases/decreases 1 hour: "xh" and "OFF" indications appear on the display.

The control panel will display "SLEEP" ON LCD when SLEEP function set.

## Operation Mode

### 1. In COOL, DRY mode

One hour after sleeping operation start, the temperature is 1°C higher than the setting one. After another hour, temperature rises 1°C: sleep run continuously for another 6 hours and then stops. The actual temperature is higher than the setting one which is to prevent from being too cold to your sleep.

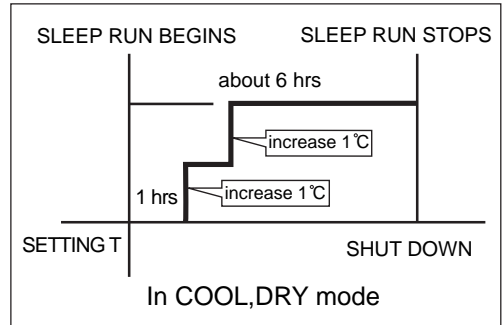

### 2. In HEAT mode

One hour after sleeping operation start, the temperature is 2°C lower than the setting one. After another hour, temperature decreases by 2°C more. Temperature will automatically rise by 1°C after another 3 hours' continuous operation. The actual temperature is lower than the setting one which is to prevent from being too hot to your sleep.

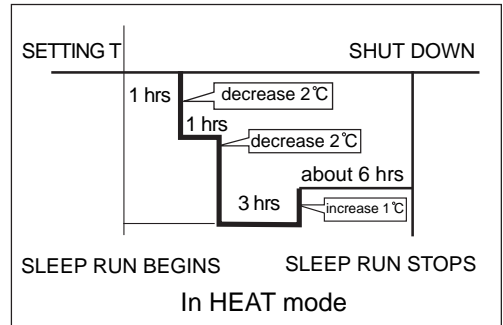

### 3. In AUTO mode.

The air conditioner will run in corresponding sleep operation according to the automatically selected operation mode.

## Notes:

- After setting SLEEP function, it is not possible to set clock.
- If set-sleep time does not reach 8 hours, unit will automatically stop operation after set time is reached.
- Set "TIMER ON" or "TIMER OFF" in COOL, DRY mode function first, then set SLEEP. After set SLEEP function, the TIMER function cannot be set.

## Remote controller

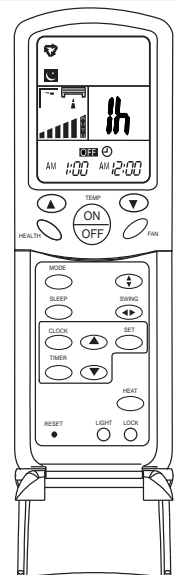

### Manual Operation Control panel



Set clock correctly before starting TIMER operation

### Remote controller

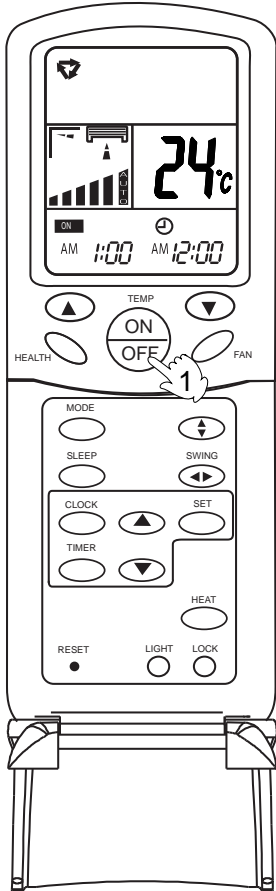

#### 1. Unit start

After unit start, select your desired operation mode (operation mode will be displayed on LCD)

#### 2. TIMER mode selection

Press TIMER button on the remote controller to change TIMER mode. Every time the button is pressed, display of TIMER mode changes as follows:



Then select TIMER mode as needed (TIMER ON or TIMER OFF). Now **ON** or **OFF** will flash.

#### 3. TIMER setting (press time adjust buttons $\blacktriangle$ )

- ▲ Every time the button is pressed, time increases 1 minuts. If the button is kept pressed, time changes quickly.
- ▼ Every time the button is pressed, time decreases 1 minuts. If the button is kept pressed, time changes quickly. It can be adjusted within 24 hours at will.

#### 4. Confirm setting

After setting correct time, press SET button to confirm time. Now **ON** or **OFF** stop flashing.

The control panel will display TIMER.

#### 5. Cancel TIMER mode

Just press TIMER button several times until TIMER mode disappears.

#### Hints:

After replacing batteries or if a power failure occurs, TIMER setting must be reset. Remote controller has memory function. When you use TIMER mode next time, just press SET button after mode selection if timer setting is the same as the previous one.

#### Note:

After setting TIMER function, the remote controller displays TIMER time.

### Manual Operation Control panel



### Remote controller

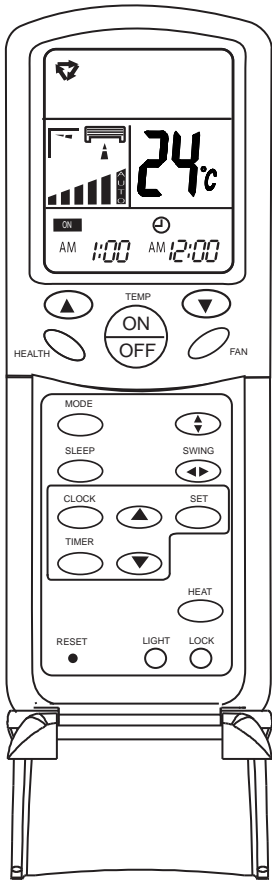

Set clock correctly before starting TIMER operation

#### 1. Unit start

After unit start, select your desired operation mode (operation mode will be displayed on LCD)

#### 2. TIMER mode selection

Press TIMER button on the remote controller to change TIMER mode. Every time the button is pressed, display of TIMER mode changes as follows:



Then select TIMER ON-OFF mode. **ON** will flash.

#### 3. Time setting for TIMER ON

Press time button  $\blacklozenge$

- ▲ Every time the button is pressed, time increases 10 minuts. If the button is kept pressed, time will changes quickly.
- ▼ Every time the button is pressed, time decreases 10 minuts. If the button is kept pressed ,time will changes quickly. It can be adjusted within 24 hours at will. AM refers to morning and PM refers to afternoon.

#### 4. Timer confirming for TIMER ON

After setting correct time, press TIMER button to confirm time. Now **ON** stops to flash, while **OFF** starts flashing.

#### 5. Timer setting for TIMER OFF

Press time buttons  $\blacklozenge$  and follow the same procedures in " Time setting for TIMER ON"

#### 6. Time confirming for TIMER OFF

After time setting, press SET button to confirm time. **OFF** stops to flash.

The control panel will display TIMER.

#### 7. Canel TIMER mode

Just press TIMER button several times until TIMER mode disappears.

According to the time setting sequence of TIMER ON and TIMER OFF, either start-stops or stops-start can be realized.

If the time setting of TIMER ON is the same as TIMER OFF, TIMER ON-OFF function cannot be set.

### Control panel



### Display function

#### 1. Control panel display control:

Press the LIGHT button ,the LCD will display according to the following sequence when press once :

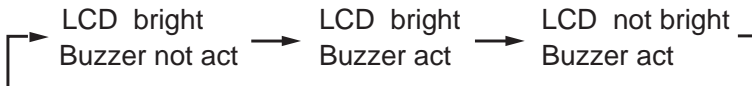

#### 2.LCD color control:

Function	Color	Priority	Function	Color	Priority
Auto	White & Pink	1	Blowing	Yellow & Green	1
Cooling	Blue	1	Negativeion& Anti-bacterial	Green	2
Heating & Auxillary	Red	1	Double fresh air	Pink	3
Dehumididy	Light blue	1			

When the LCD bright ,the color will display according to the above standard color ,when two or more than two kinds of functions operate,the color will display according the priority class (Sequence from High to low 3 2 1 ).

When cut off the power and restart the power ,the room temp. will be displayed after full screen display lasting 5 seconds .Press the panel button or remote control ,the air conditioner will send out music sound .

# ■ Operation hints

---

## **Unit operation**

---

- Protection devices inside the unit will activate to stop unit operation, when ambient temp. is extremely low or high.
- When unit is running under high humidity in cooling or dehumidifying mode, condensate might appear at outlet grill.

## **3-min delay protection**

---

- Unit will not restart until 3 min have elapsed for the protection of the unit.

## **Fan speed changes**

---

- When Fan speed is set at Auto in cooling mode, it will be automatically reduced as room temp. is approaching temp. setting.
- In dry mode, fan speed will change automatically.

## **Cold draft prevention**

---

- In heating mode, indoor fan will not run for the first 2-5 min. due to cold draft prevention.

## **Defrosting**

---

- When frost accumulates on heat exchanger in heating mode, unit will start defrosting automatically.
- During defrosting, both indoor and outdoor fan stop.
- After defrosting, unit resumes running.

## **Use objectively**

---

- Heat pump works by means of absorbing outside heat to warm room air, so outdoor temp. degree will affect unit's heating efficiency.

# Energy saving

## Keep proper room temp.

Too cold or too warm is no good to your health, and power consumption will be increased as well.

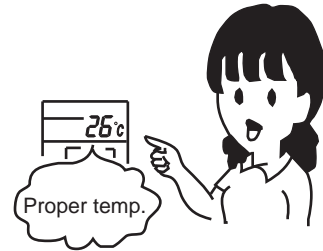

## Air filter should be periodically cleaned

If air filter is clogged:  
It will cause poor cooling and heating efficiency, higher power consumption and even problem may occur. In cooling operation, water will flow out.

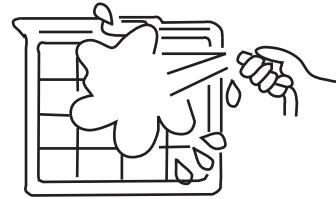

## Use Timer effectively

You may use Timer mode to keep a comfortable room temp. when you wake up or come home from outside.

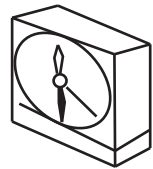
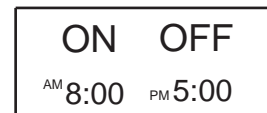

## Avoid direct sunlight and air flow





## Adjust air flow properly



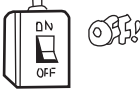

# Maintenance

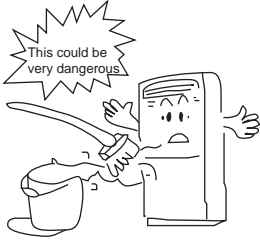
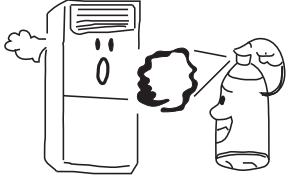
Disconnect power supply	Don't touch it with wet hand	Don't wash with hot water or solvent to clean the unit
		
Don't splash water directly on indoor unit. 	Don't spray any paint or insecticide on the unit.  This will cause damage or even fire accident.	

## Air filter cleaning

- Pull it out from top as shown in Fig.
- Use water or vacuum cleaner to clean it. If it is extremely dirty, wash it with neutral detergent or soap water.
- Wash it with clean water and install it after complete dry.

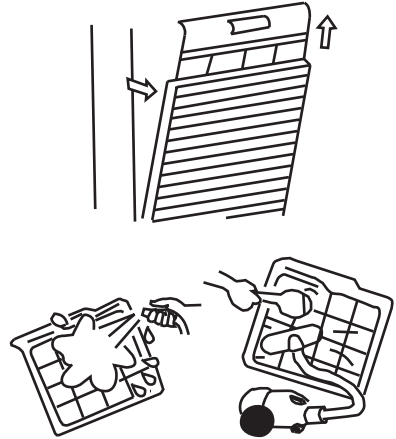

### Caution:

- Don't use hot water over 40 °C, as this may cause damage to air filter.
- Wipe air filter carefully.

# ■ Maintenance

## Indoor and outdoor cleaning

- Clean it with warm and wet cloth or with neutral detergent, then wipe it dry with clean and soft cloth.
- If air conditioner is very dirty, clean it with cloth soaked in neutral detergent, then wipe off the detergent with clean water.
- Don't use water higher than 40°C, which will cause discoloring and deformation.
- Don't use insecticide or other chemical detergents.

## After season maintenance

---

- Let the unit run in Fan mode for half a day in a fine weather to dry completely the unit inside.
- Turn off the unit and pull out power plug.
- There might be certain power consumption even if unit is stopped.
- Clean air filter and indoor unit, cover outdoor unit after cleaning.

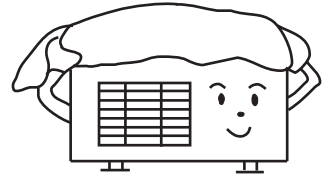
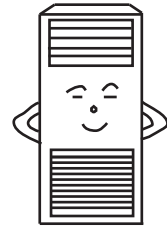

## Before season maintenance

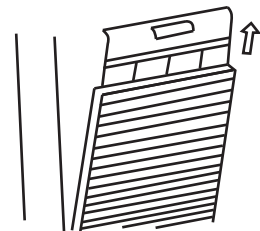

---

- Check if there are obstacles at inlet and outlet of indoor and outdoor unit, which will reduce unit efficiency.
- Don't fail to attach air filter after making sure it is cleaned.
- Dust will enter into unit causing damages or faults if it is running without air filter.
- To protect compressor at start, please connect external power supply to the unit 12 hrs prior to starting. Also please keep the power supply switch ON during the whole season.





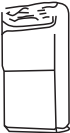

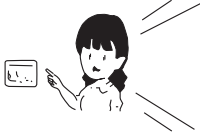
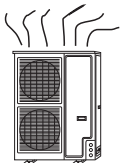
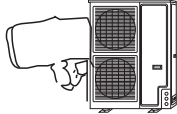
# ■ Trouble shooting

## Followings are not problems

<p>Sound of water flowings are not problems.</p> 	<p>During unit start and operation or at stop, a swishing or gurgling noise may be heard. This noise is generated by refrigerant flowing in the system.</p>
<p>Sound of cracking is heard.</p>	<p>During unit operation, a cracking noise may be heard. This noise is generated by the casing expanding or shrinking because of temperature changes.</p>
<p>Smells are generated.</p>	<p>This is because the system circulates smells from the interior air such as the smell of cigarettes or the painting on the unit.</p>
<p>During operation, white fog or steam comes out of indoor unit.</p> 	<p>When unit is running at places like restaurant where dense edible oil fumeis always exist, this will happen.</p>
<p>In cooling operation, unit switches to fan operation.</p>	<p>To prevent frost from accumulating on indoor heat exchanger, unit will switch to fan operation for a while then resume cooling operation.</p>
<p>Unit will not restart after stop. Won't start?</p> 	<p>Though ON/OFF button is set to ON, unit won't resume cooling, dry or heating operation in 3 min after it is stopped, this is because of 3-min-delay protection circuit.</p>  <p style="text-align: center;">Please wait 3 minutes</p>
<p>No outlet air or fan speed can't be changed in dry mode.</p>	<p>Unit will reduce fan speed repeatedly and automatically if room temp. is too low in dry operation.</p>
<p>In heating operation, water or steam are blown out of indoor unit.</p> 	<p>This occurs when frost accumulated on the outdoor unit is removed. (during defrosting operation)</p> 
<p>In heating operation, indoor fan won't stop even if unit is stopped.</p>	<p>After unit stops, indoor fan will go on running until indoor unit cools down.</p>

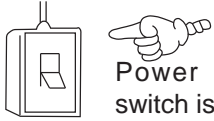
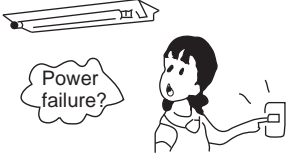
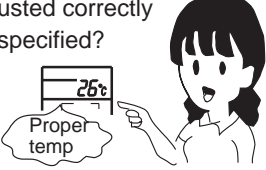
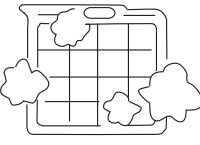
# When problems occur

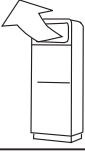
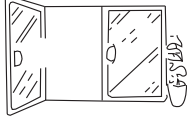
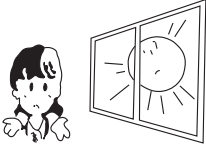
Before asking services, please firstly check your unit according to following.

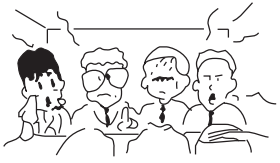
Air conditioner won't start.		
<p>Is power supply switch turned on?</p>  <p>Power supply switch is not set at ON.</p>	<p>Is city power supply normal?</p>  <p>Power failure?</p>	<p>Is leakage current breaker activated?</p> <p>This is very dangerous, please disconnect power supply immediately and contact your dealer.</p>
Poor cooling or heating		
<p>Are operation controls adjusted correctly as specified?</p>  <p>Proper temp</p>	<p>Is air filter too dirty?</p> 	<p>Are there any obstacles at inlet or outlet grill?</p> 
<p>Are horizontal louvers at up position (in heating mode)?</p> 	<p>Any doors or windows left open?</p> 	
Poor cooling		
<p>Is there any direct sunlight in the room?</p> 	<p>If there are unexpected heat sources in the room?</p> 	<p>Too many people in the room?</p> 

If your unit still can't work properly after above mentioned checks, or following problems occur, please stop it immediately and contact your dealer.

- Fuses or circuit breakers often blow out.
- Water comes out in cooling/dry operation.
- Operation is abnormal or sound is heard.

If the fuse on PC board is broken please change it with the type of T3.15A/250VAC.

# ■ When problems occur

## 1. Errors display

Failure description	Code on LCD display
Drainage system abnormal	E0
Room temp. sensor abnormal	E1
Indoor coil temp. sensor abnormal	E2
Outdoor temp. sensor abnormal	E3
Outdoor coil temp. sensor or discharge temp. sensor abnormal	E4
The phase sequence of power abnormal or over current malfunction	E5
Outdoor high pressure or low pressure abnormal	E6
The communication between indoor PCB and control board abnormal	E8
The communication between indoor PCB and outdoor PCB abnormal	E9

## 2. Power supply

- Use copper wire only, the parameter of connecting cable is H05RN-F 4G 0.75mm<sup>2</sup>.
- The power cable should be over H07RN-F 5G 2.5mm<sup>2</sup>(AP482AKEAA)
- The power cable should be over H07RN-F 5G 4.0mm<sup>2</sup>(AP602AKEAA)
- Air conditioner must use an exclusive line (over 30A)
- When installation air conditioner in a wet place, try to use a circuit breaker against current leakage.
- For installation in other places, use circuit breaker as far as possible.
- The breaker of the air conditioner should be all-pole switch ; and the distance between its two contacts should be no less than 3 mm.
- Such means for disconnection must be incorporation in the fixed wiring

## 3. Charge-over switch.

For AP482AKEAA, the charge-over switch is set:

BM1: 1 OFF 2 ON  
BM2: 1 OFF 2 OFF 3 OFF 4 OFF  
BM3: 1 OFF 2 OFF 3 OFF 4 OFF  
BM4: 1 OFF 2 ON

For AP602AKEAA, the charge-over switch is set:

BM1: 1 OFF 2 ON  
BM2: 1 OFF 2 OFF 3 OFF 4 OFF  
BM3: 1 OFF 2 OFF 3 OFF 4 OFF  
BM4: 1 OFF 2 ON

# Indoor & outdoor unit connection

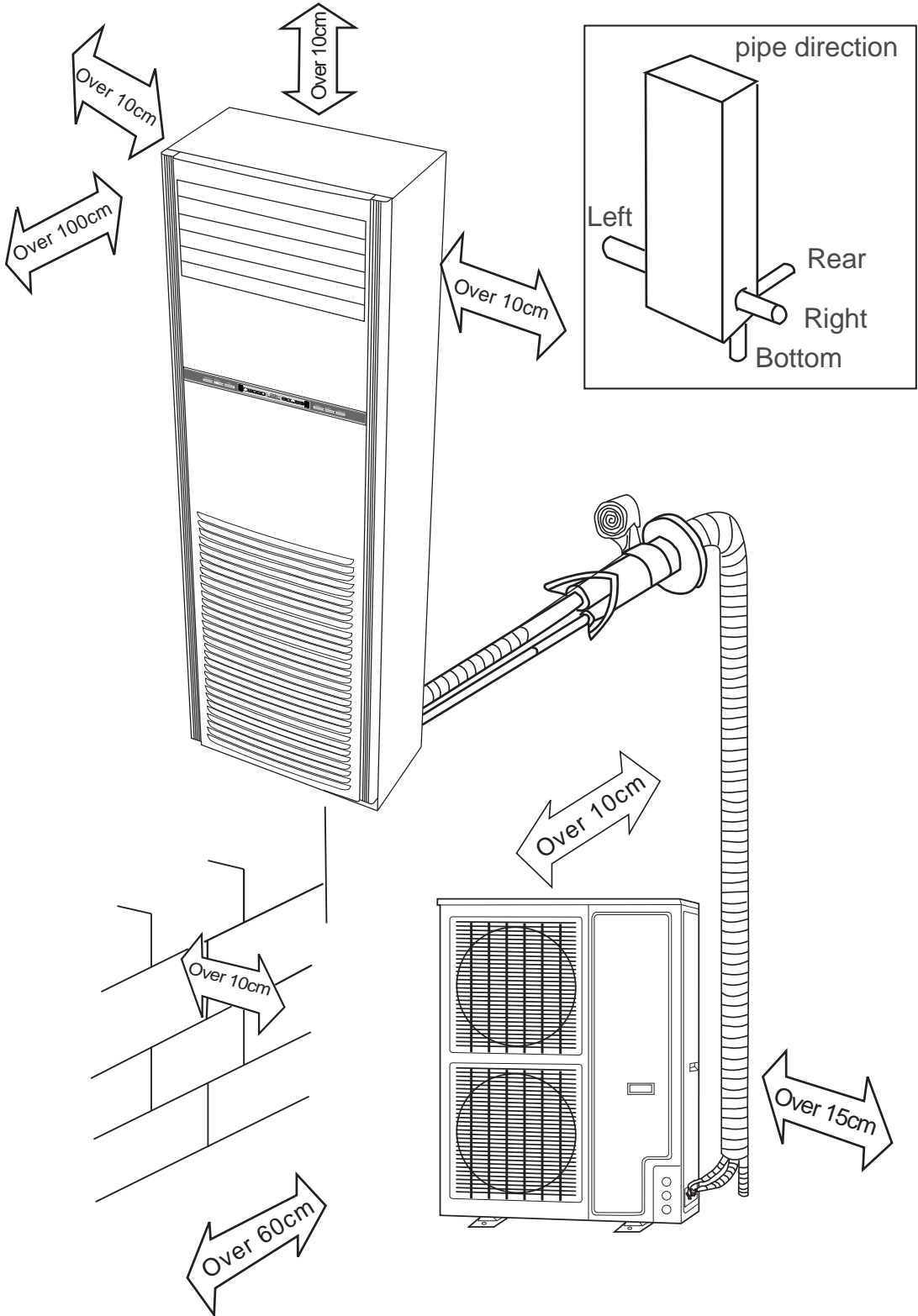

# ■ Tools necessary

---

## Tools necessary

1. Screw driver
2. Hacksaw
3. 70mm dia. hole core drill
4. Spanner (dia. 22, 36mm)
5. Spanner (16, 18, 22, 36mm)
6. Pipe cutter
7. Flaring tool
8. Knife
9. Nipper
10. Gas leakage detector or soap water
11. Measuring tape
12. Reamer
13. Refrigerant oil

## Standard accessories

Following parts shall be field supplied

Mark	Parts name
(A)	Adhesive tape
(B)	Pipe clip
(C)	Connecting hose
(D)	Insulation material
(E)	Putty
(F)	Drain hose

# Installation procedures

## Display of whole unit

- Try to bring the packed unit to the installation place.
- When it is inevitable to unpack the unit, be careful not to damage the unit. Wrap it with nylon etc.
- After unpacking, be sure to put it with the front side of the unit facing up.

Delivery

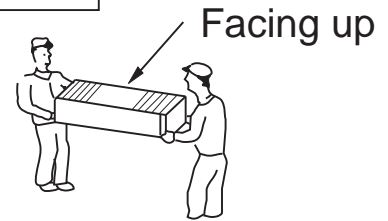

- Note: When delivering, don't hold plastic parts like inlet and outlet grill etc.

## Installation of outdoor unit

### Selection of installation place

- Place strong enough to support the unit and will not cause vibration and noise.
- Place where discharged wind and noise doesn't cause a nuisance to the neighbors.
- Place where is less affected by rain or direct sunlight and is sufficiently ventilated, or to install a shield.
- Place with enough space for smooth air flow.

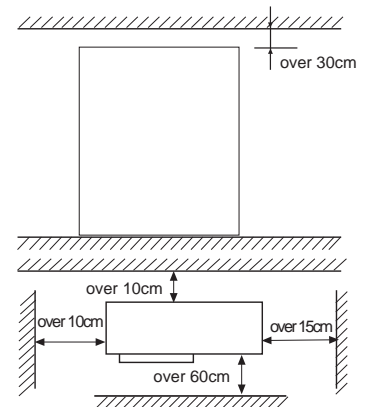

### Fixing of the unit

- Fix outdoor unit using M10 bolt to concrete floor horizontally.
- If installed on the wall or on top of a roof, bracket should be fixed securely to resist earthquake or storms.
- Use rubber pad during installation against unit vibration.

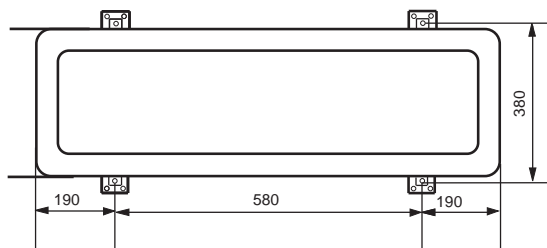

Installation dimension of outdoor unit (mm)



# Installation procedures

## Installation of indoor unit

Selection of installation place

Place where it is easy to route drainage pipe and outdoor piping.

Place away from heat source and with less direct sunlight.

Place where cool and warm air could be delivered evenly to every corner of the room.

Place near power supply socket. Leave enough space around the unit (refer to installation drawings).

## Fixing of the unit

### 1. Position of the wall hole

Wall hole should be decided according to installation place and piping direction. (refer to installation drawings)

### 2. Making a wall hole

Drill a hole of 70mm dia. with a little slope towards outside.

Install piping hole cover and seal it with putty after installation.

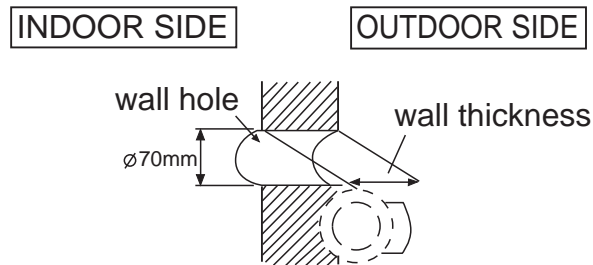

( Cross section of wall hole )

## Fixing of indoor unit

With the unit set up vertically, fix the fitting metal to the unit with screws, then fix the fitting metal to the wall with cement nail and washer, as shown below:

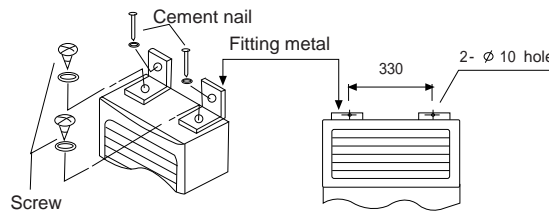

Moreover, if want to fix the unit more firmly, you should fix the bottom panel to the ground with concrete bolts, as shown below:

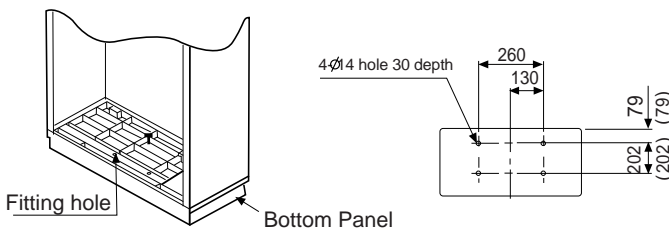

# Installation procedures

## Piping connection

### 1. Connecting method

Apply refrigerant oil at half union and flare nut.

To bend a pipe, give the roundness as large as possible not to crash the pipe.

When connecting pipe, hold the pipe centre to centre then screw nut on by hand, refer to Fig.

Be careful not to let sundries, such as sands enter the pipe.

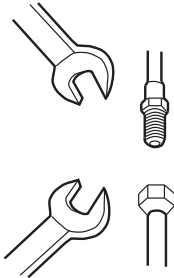

Forced fastening without centering may damage the threads and cause a gas leakage.

Pipe dia	Fastening torque
Liquid pipe 9.52mm(3/8")	32.7-39.9N·m
Gas pipe 19.05mm(3/4")	97.2-118.6N·m

### 2. Piping connection of indoor unit

Arrangement of piping and drainage pipe



After opening inlet grill, you will see a control box as shown in the Fig.

Remove the cover before wiring work.

Cut away, with a hammer or a saw, the lid for piping according to piping direction.

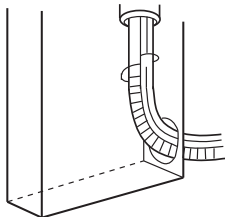

Insulation material

Copper tube

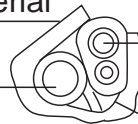

Drain hose

Connecting electric cable for indoor and outdoor unit

According to the piping method, connect the piping on indoor unit with union of connecting pipe.

Arrange the piping as per the wall hole and bind drain hose connecting electric cable and piping together with polyethylene tape.

Insert the bound piping connecting electric cable and drain hose through wall hole to connect with outdoor unit.

# ■ Installation procedures

## Arrangement of drain hose

- Drain hose shall be placed in under place.
- There should be a slope when arrange drain hose. Avoid up and down waves in drain hose.



If humidity is high, drain pipe( especially in room and indoor unit ) must be covered with insulation material.

## 3. Piping connection of outdoor unit.

Connect the connecting pipe and inlet and outlet liquid pipe according to the piping method.

## 4.Purging method

Discharge the air out of the indoor unit and the refrigerant pipe by vacuumizing

(1) Fasten all the nuts of the indoor and outdoor pipes to make these parts out of leakage.

(2) Under the condition of the complete close of the indoor and outdoor valve center (both liquid and gas side),dismount the repair valve cap.Vacuumizing through the charge mouth of the repair valve.

(3) After vacuumizing fasten the repair valve,and dismount the cap of the big and small stop valve, then loosen the stop valve center completely and fasten the big and small stop valve.

### Note:

- Electric wiring must be done by qualified person.
- The power supply connects from the outdoor unit.
- The connecting cable and power cable are self-provided.

### Wiring of indoor unit

- Insert the cable from outside the wall hole where piping already exist.
- Pull it out from front.
- Loosen terminal screws and insert cable end fully into terminal block, then tighten it.
- Pull the cable gently to make sure it is tight.
- Replace cover after wiring.

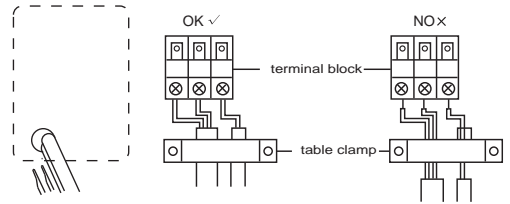

### Wiring of outdoor unit

- Insert the cable from inside the wall hole where piping already exists.
- Pull it out from front.
- Loose terminal screw and insert cable end fully into terminal block, then tighten it.
- Pull the cable gently to make sure it is tight.
- Replace cover after wiring.

AP482AKEAA AP602AKEAA

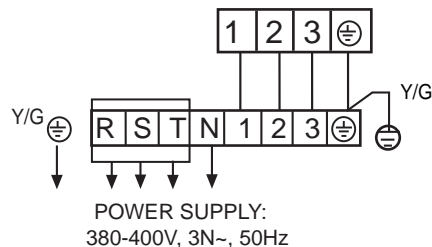

### Note:

When connecting indoor and outdoor wire, check the number on indoor and outdoor terminal blocks. Incorrect wiring may damage air conditioner's controller or cause operation failure.

# Others

## 1. Pipe cutting and flaring

- Be sure to carry out deburring after pipe cutting with a pipe cutter.
- Insert flaring tool to make a flare.

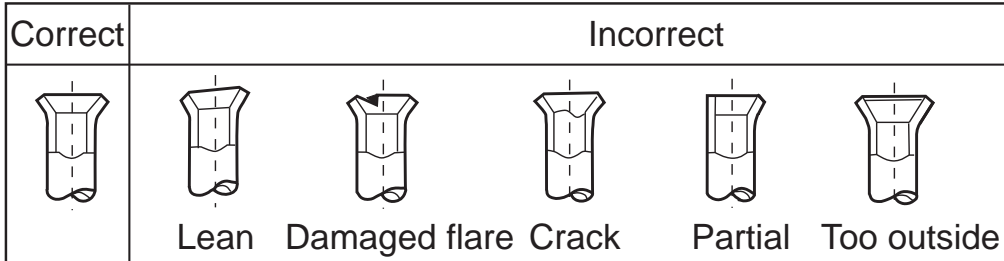

	Pipe dia.	Dimension A(mm)
Liquid pipe	∅ 9.52mm (3/8")	1.0 ~ 1.8
Gas pipe	∅ 19.05mm (3/4")	1.4 ~ 2.2

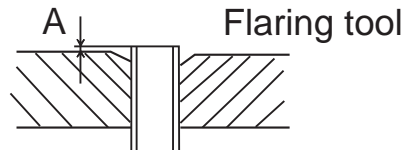

## 2. Installation inspection and test run:

Please operate unit according to this Manual.

Items to be checked during test run. Please made a "✓" in "□"

- Are there any gas leakage?
- How is insulation at piping connection carried out?
- Are electric wires of indoor and outdoor unit firmly inserted into terminal block?
- Is electric wiring of indoor and outdoor securely fixed?
- Is drainage securely carried out?
- Is earth line ( grounding ) securely connected?
- Is power supply voltage abided by the code?
- Is there any noise?
- Is control display normal?
- Is cooling operation normal?
- Is room temp. regulator normal?

**HAIER GROUP**

Qingdao Haier Air Conditioner Electric Co., Ltd.

Address: Haier Garden, Qianwangang Road, Economic Development Zone,  
Qingdao, Shandong 266500, P.R.China

Web Site: <http://www.haier.com>