

**Box contents**

---

1 Speaker

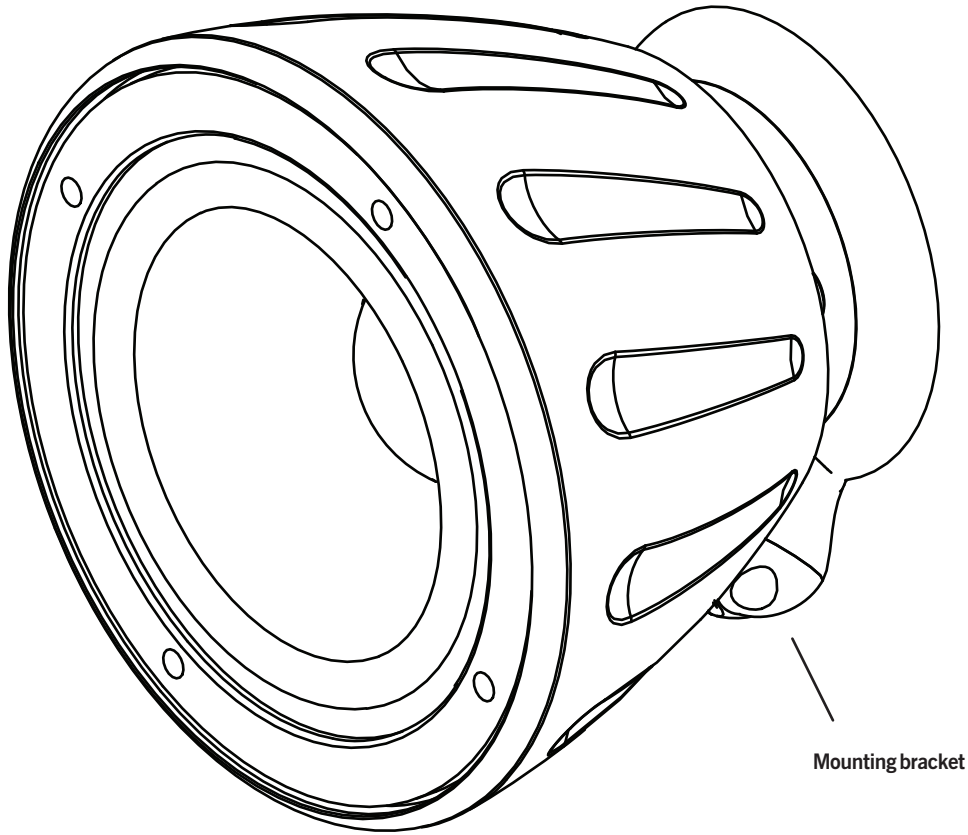

Thank you for choosing Phase Technology speakers. We know there are a wide variety of choices available today, and we sincerely appreciate your purchase of our product. Phase Technology speakers are built to exacting standards and will provide many years of listening enjoyment.

Our speakers are the result of over five decades of designing and manufacturing. We hold many key patents in loudspeaker technology including the soft-dome tweeter. Our mission, our passion is to constantly advance the art and science of accurate audio reproduction. Our dedication insures your new speakers will accurately reproduce all the impact, detail and delicacy of today's digital technology.

Regardless of application, serious audiophile listening or home theater, we recommend that you take the time to read this manual thoroughly before connecting speakers to your amplifier or receiver. In the highly unlikely event that you should experience a problem with set-up or operation, please contact one of our authorized dealers for assistance, or contact us directly.

We trust that your new Phase Technology speakers will enrich your enjoyment of music and movies beyond your expectations.

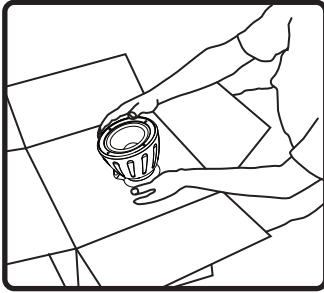

**1.** Unpack speaker.

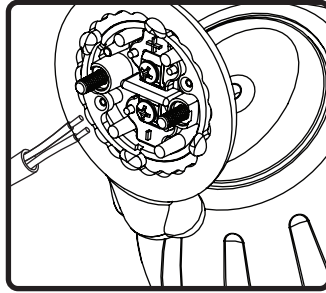

**2.** Connect speaker wire leads to the terminal screws on the back of the base plate. Polarity is indicated.

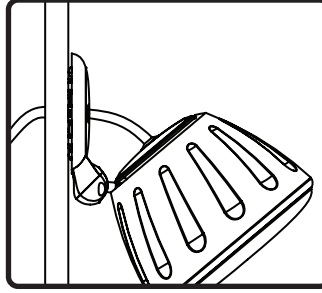

**3a.** If mounting the speaker directly over the wire, ensure the base plate covers the hole in wall.

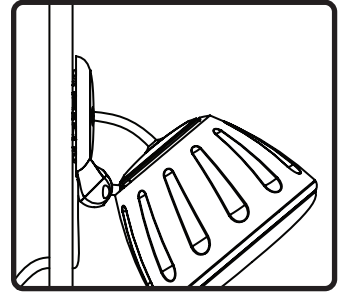

**3b.** If mounting speaker offset from wiring point, run wire out hole in wall and behind base plate through 2 mm standoff gap between base plate and wall. The standoff gap accepts up to 18 gauge flat signal wire.

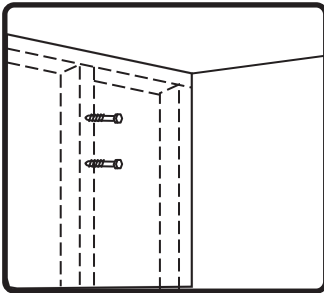

**4.** Choose a secure mounting surface with sufficient strength to reliably hold the speaker.

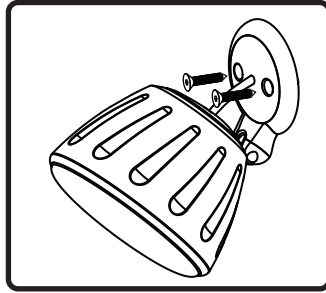

**5.** Attach speaker to surface using installer-supplied fasteners.

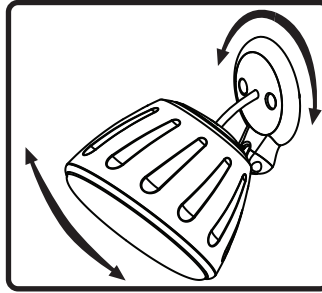

**6.** Aim speaker by pointing it up or down and/or rotating it.

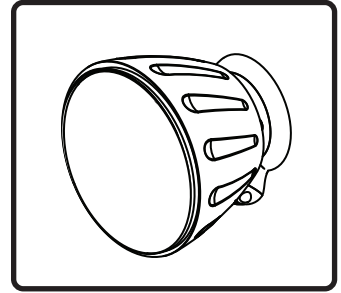

**7.** Done!