

# R410A MULTI SPLIT SERIES ROOM AIR CONDITIONER

## LOW E.S.P. DUCT TYPE INDOOR UNITS OPERATION & INSTALLATION MANUAL

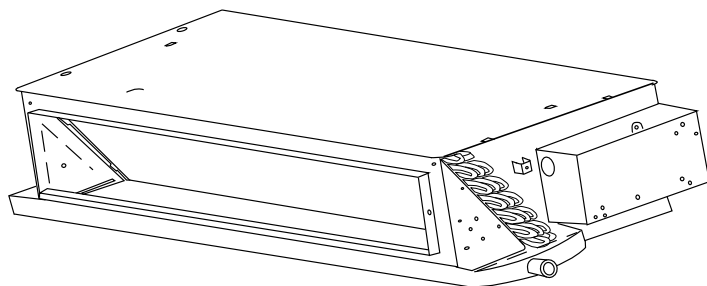

AD092XLERA

AD122XLERA

AD142XLERA

AD182XLERA

No.0010577705

- Please read this manual carefully before using this air conditioner.
- Please keep this manual safely for future use.

# ■ Contents

---

Cautions .....	1-2
Safety precautions.....	3-5
Notes for safety.....	6
Parts and Functions .....	7
Trouble shooting .....	8-9
Customer Need-to-know .....	10
When trouble happens.....	11
Operation and Maintenance .....	12-23
Failure code .....	24-25

# ■ Cautions

## Disposal of the old air conditioner

Before disposing an old air conditioner that goes out of use, please make sure it's inoperative and safe. Unplug the air conditioner in order to avoid the risk of child entrapment.

It must be noticed that air conditioner system contains refrigerants, which require specialized waste disposal. The valuable materials contained in a air conditioner can be recycled. Contact your local waste disposal center for proper disposal of an old air conditioner and contact your local authority or your dealer if you have any question. Please ensure that the pipework of your air conditioner does not get damaged prior to being picked up by the relevant waste disposal center, and contribute to environmental awareness by insisting on an appropriate, anti-pollution method of disposal.

## Disposal of the packaging of your new air conditioner

All the packaging materials employed in the package of your new air conditioner may be disposed without any danger to the environment.

The cardboard box may be broken or cut into smaller pieces and given to a waste paper disposal service. The wrapping bag made of polyethylene and the polyethylene foam pads contain no fluorochloric hydrocarbon.

All these valuable materials may be taken to a waste collecting center and used again after adequate recycling.

Consult your local authorities for the name and address of the waste materials collecting centers and waste paper disposal services nearest to your house.

## Safety Instructions and Warnings

Before starting the air conditioner, read the information given in the User's Guide carefully. The User's Guide contains very important observations relating to the assembly, operation and maintenance of the air conditioner.

The manufacturer does not accept responsibility for any damage that may arise due to non-observation of the following instructions.

- Damaged air conditioners are not to be put into operation. In case of doubt, consult your supplier.
- Use of the air conditioner is to be carried out in strict compliance with the relative instructions set forth in the User's Guide.
- Installation shall be done by professional people, and don't install the unit by yourself.
- For the purpose of safety, the air conditioner must be properly grounded in accordance with specifications.
- Always remember not to operate the air conditioner before opening its inlet grill.
- All electrical repairs must be carried out by qualified electricians. Inadequate repairs may result in a major source of danger for the user of the air conditioner.
- Do not damage any parts of the air conditioner that carry refrigerant by piercing or perforating the air conditioner's tubes with sharp or pointed items, crushing or twisting any tubes, or scraping the coatings off the surfaces. If the refrigerant spurts out and gets into eyes, it may result in serious eye injuries.

# ■ Cautions

- Do not obstruct or cover the ventilation grille of the air conditioner. Do not put fingers or any other things into the inlet/outlet and swing louver.
- Do not allow children to play with the air conditioner. In no case should children be allowed to sit on the outdoor unit.

## Specifications

The refrigerating circuit is leak-proof.  
The machine is adaptive in following situation:

### 1.Applicable ambient temperature range:

			Rated	Maximum	Minimum
Cooling	Indoor	DB °C	27	32	18
		WB °C	19	23	14
	outdoor	DB °C	35	43	10
		WB °C	24	26	6
Heating	Indoor	DB °C	20	27	15
		WB °C	14.5	--	--
	outdoor	DB °C	7	24	-15
		WB °C	6	18	--

2. If the supply cord is damaged, it must be replaced by the manufacturer or its service agent or a similar qualified person.
3. If the fuse on PC board is broken, please change it with the type of T 3.15A /250VAC.
4. The wiring method should be in line with the local wiring standard.
5. The power cable and connecting cable are self-provided.

The requirement of the connecting cable:

Model	Connecting cable
AD092XLERA	Power cable: H05RN-F 3G 2.5mm <sup>2</sup> Signal wires: H05RN-F 2X1.5mm <sup>2</sup>
AD122XLERA	
AD142XLERA	
AD182XLERA	

All the cables shall have got the local authentication certificate.

6. The breaker of the air conditioner should be all-pole switch; and the distance between its two contacts should be no less than 3mm. Such means for disconnection must be incorporation in the fixed wiring.
7. The waste battery shall be disposed properly.
8. The appliance is not intended for use young children or infirm persons without super vision.
9. Young children should be supervised to ensure that they do not play the appliance.

# ■ Safety precautions

Carefully read the following information in order to operate the air conditioner correctly.

Below are listed three kinds of Safety Cautions and Suggestions.

**WARNING!** Incorrect operations may result in severe consequences of death or serious injuries.

**CAUTION!** Incorrect operations may result in injuries or machine damages; in some cases may cause serious consequences.

**INSTRUCTIONS:** These information can ensure the correct operation of the machine.

Be sure to conform with the following important Safety Cautions.

The Safety Cautions should be at hand so that they can be checked at any time when needed.

If the conditioner is transferred to the new user, this manual should be as well transferred to the new user.

## WARNING!

- **Don't blow the human body with the cooling air too long, and don't let the room temperature decrease too low either.**

Otherwise the one will feel unpleasant or harm ones' health.

- **If any abnormal phenomena is found (e. g. smell of firing), please cut off the power supply immediately, and contact the dealer to find out the handling method.**

In such case, to continue using the conditioner will damage the conditioner, and may cause electrical shock or fire hazard.



- **When need maintenance and repairment, call dealer to handle it.**

Incorrect maintenance and repairment may cause water leak, electrical shock and fire hazard.

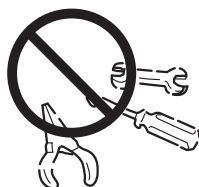

- **Please let the dealer be responsible for installing the conditioner.**

Incorrect installation may cause water leak, electrical shock and fire hazard.

- **Don't put fingers or any other things into the inlet/outlet and swing louver while the conditioner is in operation.**

Because the highspeed fan is very dangerous and may cause injuries.

- **Call the dealer to take measures to prevent the refrigerant from leaking.**

If conditioner is installed in a small room, be sure to take every measure in order to prevent suffocation accident even in case of refrigerant leakage.

- **When conditioner is deinstalled or reinstalled dealer should be responsible for them.**

Incorrect installation may cause water leaking, electrical shock and fire hazard.

# ■ Safety precautions

## CAUTIONS!

- **Conditioner should not be used for any other purpose other than airconditioning.**

Don't use air-conditioner for any other special purposes, e.g. the preservation and protection of food, animals, plants, precision apparatus as well as work of art, otherwise the qualities of these stuffs may be damaged.

- **Don't dismantle the outlet of the outdoor unit.**

The exposure of fan is very dangerous which may harm human beings.



- **When air-conditioner is co-used with other heat-radiator the frequent replacement of room atmosphere should be required.**

Inefficient ventilation may cause suffocation.



- **After a long time use of air-conditioner the base should be checked for any damages.**

If the damaged base is not repaired, the unit may fall down and cause accidents.



- **No goods or nobody is permitted to be placed on or stand on outdoor unit.**

The falling of goods and people may cause accidents.



- **Pets and plants should not be blowed directly in the air flow.**

Otherwise will suffer damage.

- **Don't operate the air-conditioner with damp hands.**

Otherwise will be shocked.



- **Only use correctly-typed fuse.**

May not use wire or any other materials replacing fuse, otherwise may cause faults or fire accidents.



- **Don't place any burning unit in the air flow of air-conditioner, which may cause incomplete combustion.**

- **No inflammable spray fluid should be permitted to be placed or used near to airconditioner other wise may cause fire accidents.**

- **Air-conditioner should be cleaned only after power supply is cut off to keep from shock or hurt.**

- **Don't clean air-conditioner with water.**

Otherwise may cause shock.

- **When use the fumigating insecticide don't open air-conditioner.**

Otherwise the poisonous chemicals may settle in air-conditioner which harm the health of chemical-allergic people.

# ■ Safety precautions

## CAUTIONS ON INSTALLATION

Please ask the dealer or specialist to install, never try by the users themselves. After the installation please be sure of the following conditions.

- **Please call dealer to install the air-conditioner.**

Incorrect installation may cause water leaking, shock and fire hazard.

## CAUTION !

- **Air-conditioner can't be installed in the environment with inflammable gases because the inflammable gases near to air-conditioner may cause fire hazard.**

- **Installed electrical-leaking circuit breaker.**

It easily cause electrical shock without circuit breaker.

### [Location]

- Air-conditioner should be located in well-vented and easily-accessible place.
- Air-conditioner should not be located in the following places:
  - (a) Places with machine oils or other oil vapours.
  - (b) Seaside with high salt content in the air.
  - (c) Near to hot spring with high content of sulfide gases.
  - (d) Area with frequent fluctuation of voltage e.g. factory, etc.
  - (e) In vehicles or ships.
  - (f) Kitchen with heavy oil vapour or humidity.
  - (g) Near to the machine emitting electric-magnetic waves.
  - (h) Places with acid, alkali vapour.
- TV, radio, acoustic appliances etc are at least 1 m far away to the indoor unit, outdoor unit, power supply wire, connecting wire, pipes, otherwise images may be disturbed or noises be created.

- **Connect earthing wire.**

Earthing wire should not be connected to the gas pipe, water pipe, lightning rod or phone line, in-correct earthing may cause shock.



- **Use discharge pipe correctly to ensure efficient discharge.**

Incorrect pipe use may cause water leaking.

- As required, take measures against heavy snow.

### [Wiring]

- Air-conditioner should be equipped with special power supply wire.

### [Operating noise]

- Chose the following locations:
  - (a) Capable of supporting air-conditioner weight, don't increase operating noise and vibration.
  - (b) Hot vapour from outdoor unit outlet and operating noise don't disturb neighbour.
- No obstacles around the outdoor unit outlet.

# ■ Notes for safety

---

**ⓘ The instructions with this warning mark must be carried out strictly, for they are all concerned with safety of the product or human beings.**

- The instructions with this warning mark must be carried out strictly, for they are all concerned with safety of the product or human beings.
- Clean the dust filter periodically:
- Blockage of the dust filter would reduce the cooling and heating effect, consume more power, water would be leaked during cooling, and other failures would also occur.
- Use the fuse of required capacity:
- Never use steel wire or copper wire to take place of the fuse.
- Operate the unit with the remote controller.

**⊘ The instructions with this prohibiting mark must be completely forbidden, otherwise the product would be damaged or the human being would be injured.**

- Never connect the earth wire with the gas pipe, water pipe, lightening arrester, or phone line.
- Never install the air conditioner where the flammable gas is easily leaked.
- Do not spray any paint or insecticide on the air conditioner.
- Never pour water on the indoor unit.
- Keep the inlet and outlet of the indoor unit unblocked.
- When the louver is being swung, never touch the outlet or put anything into the air grille.



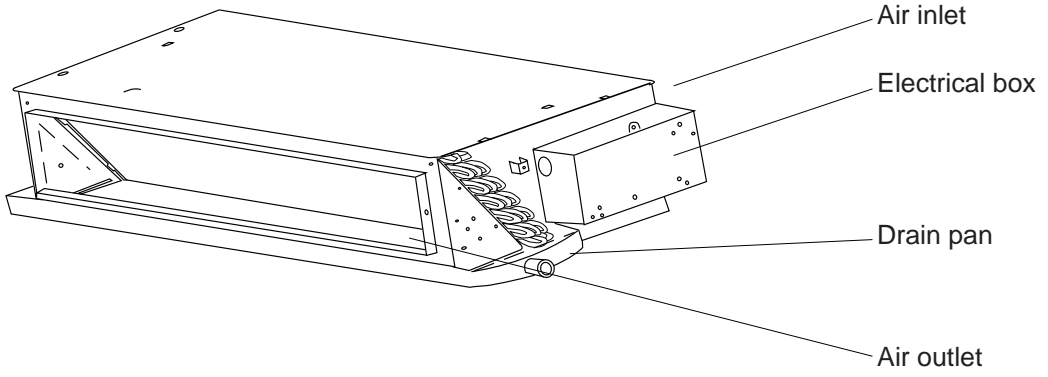

# ■ Parts and Functions

## INDOOR UNIT



# ■ Trouble shooting

## The followings are not malfunction

<p>Water flowing sound is heard</p> 	<p>When the air conditioner is started, when the compressor starts or stops during operation or when the air conditioner is stopped, it sometimes sounds 'Bi-Bi' or 'Godo-Godo'. It is the flowing sound of the refrigerant, not a malfunction.</p>
<p>Cracking sound is heard</p>	<p>This is caused by heat expansion or contraction of plastics</p>
<p>It smells.</p>	<p>Air blown out from the indoor unit sometimes smells. The smell results from smells of furniture, paint, tobacco absorbed by indoor unit.</p>
<p>During operation, white fog comes out of indoor unit.</p>	<p>When in COOL or DRY mode, a thin water fog can be seen blown out of unit, this is the condensed fog because the suddenly cooled indoor air is blown out.</p>
<p>Automatically switch into FAN mode during cooling.</p>	<p>To prevent frost from being accumulated on the indoor unit heat exchanger, it sometimes automatically switched into the FAN mode, but it will soon back to the cooling mode.</p>
<p>The air conditioner cannot be restarted soon after it stops. Air conditioner does not start?</p> 	<p>This is because of the self-protection function of the system, therefore, it cannot be restarted for about three minutes after it stops.</p>  <p>Please wait for three minutes</p>

# ■ Trouble shooting

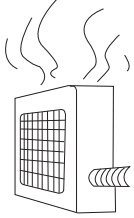
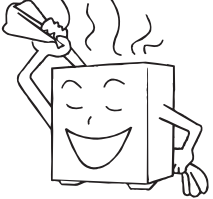
<p>Air does not blow or the fan speed cannot be changed during drying.</p>	<p>In DRY mode, when room temperature becomes 2°C higher than temperature setting, unit will run intermittently at LO speed regardless of FAN setting</p>
<p>Water or vapor generated from the outdoor unit during heating.</p> 	<p>This happens when the frost accumulated on the outdoor unit is removed (during defrosting operation).</p> <p>Defrosting operation</p> 
<p>During heating, indoor fan is still running even unit is stopped.</p>	<p>To get rid of the excess heat, indoor fan will continue running for a while after unit automatically stops.</p>

**Please check the following things about your air conditioner before making a service call.**

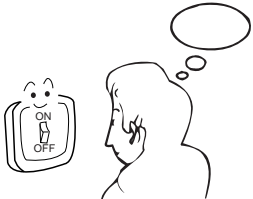
Unit fails to start.		
<p>Is the power supply switch on ?</p>  <p>Power supply switch is not in ON position.</p>	<p>Is city supply power normal ?</p> 	<p>Is the earth leakage breaker in action ?</p> <p>Be sure to turn off the power supply switch immediately and contact the sales dealer.</p>

# Customer Need-to-know

## Customer Need-to-know

- Please install the air conditioner according to the requirements specified in this manual to ensure the air conditioner work well.
- Be careful not to scratch the surface of the case during moving the air conditioner.
- Please keep the installation manual for future reference when maintenance and changing installation place.
- After installation ,please use the air conditioner according to the specification in the operation manual.

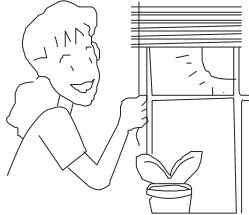
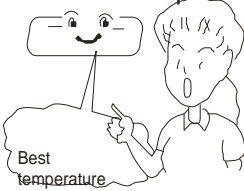
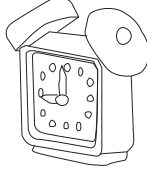

Using Directions	
<p>Adjust suitable airflow direction</p> 	<p>Avoid direct sunlight and airflow</p> 
<p>Keep the proper indoor temperature. Too cool or hot is not good for your health. Furthermore, it will result in excessive consumption of electric power.</p> 	<p>Effectively use timer. Using TIMER mode, you can make the room temperature reach a suitable temperature when you wake up or go back home.</p> 

## ATTENTION!

After finishing installation, please confirm there is no refrigerant leakage.

# ■ When trouble happens

## Insufficient cooling or heating

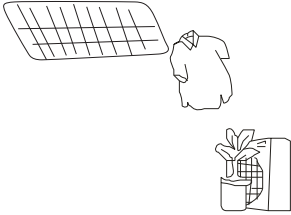
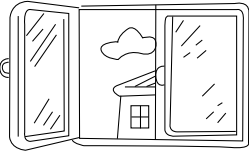
<p>The operation controller adjusted as required</p> 	<p>Air filter too dirty ?</p> 
<p>Any obstacle exists at the air inlet or outlet?</p> 	<p>Door or window left opened ?</p> 

## Insufficient cooling

<p>Any other heat sources in the room?</p> 	<p>Sunlight direct into the room ?</p> 	<p>Too crowded in the room ?</p> 
--------------------------------------------------------------------------------------------------------------------------------	----------------------------------------------------------------------------------------------------------------------------	-----------------------------------------------------------------------------------------------------------------------

## Cooled air blown out ( when heating)

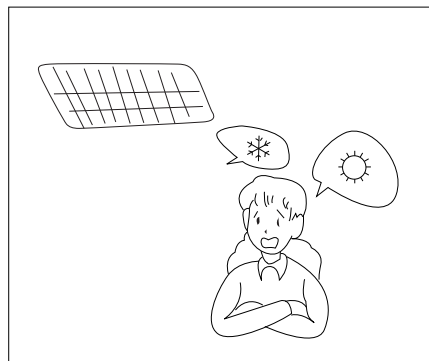





When the air conditioner does not operate properly after you have checked the above-mentioned items or when following phenomenon is observed, stop the operation of the air conditioner and contact your sales dealer.

- 1)The fuse or breaker often shuts down.
- 2)Water drops off during cooling or drying operation.
- 3)There is an irregularity in operation or abnormal sound that is audible.

# ■ Instructions to installation

## 1. Safety precautions

- Please read these "Safety Precautions" first then accurately execute the installation work.
- Though the precautionary points indicated herein are divided under two headings,  WARNING and , those points which are related to the strong possibility of an installation done in error resulting in death or serious injury are listed in the  CAUTION section. However, there is also a possibility of serious consequences in relationship to the points listed in the  CAUTION section as well.

In either case, important safety related information is indicated, so by all means, properly observe all that is mentioned.

After completing the installation, along with confirming that no abnormalities were seen from the operation tests, please explain operating methods as well as maintenance methods to the user (customer) of this equipment, based on the owner's manual.

Moreover, ask the customer to keep this sheet together with the owner's manual.

### WARNING

- This system should be applied to places as office, restaurant, residence and the like. Application to inferior environment such as engineering shop could cause equipment malfunction.
- Please entrust installation to either the company which sold you the equipment or to a professional contractor. Defects from improper installations can be the cause of water leakage, electric shocks and fires.
- Execute the installation accurately, based on following the installation manual. Again, improper installations can result in water leakage, electric shocks and fires.
- When a large air-conditioning system is installed to a small room, it is necessary to have a prior planned countermeasure for the rare case of a refrigerant leakage, to prevent the exceeding of threshold concentration. In regards to preparing this countermeasure, consult with the company from which you purchased the equipment, and make the installation accordingly. In the rare event that a refrigerant leakage and exceeding of threshold concentration does occur, there is the danger of a resultant oxygen deficiency accident.
- For installation, confirm that the installation site can sufficiently support heavy weight. When strength is insufficient, injury can result from a falling of the unit.
- Execute the prescribed installation construction to prepare for earthquakes and the strong winds of typhoons and hurricanes, etc. Improper installations can result in accidents due to a violent falling over of the unit.
- For electrical work, please see that a licensed electrician executes the work while following the safety standards related to electrical equipment, and local regulations as well as the installation instructions, and that only exclusive use circuits are used.  
Insufficient power source circuit capacity and defective installation execution can be the cause of electric shocks and fires.
- Accurately connect wiring using the proper cable, and insure that the external force of the cable is not conducted to the terminal connection part, through properly securing it. Improper connection or securing can result in heat generation or fire.
- Take care that wiring does not rise upward, and accurately install the lid/service panel.

# ■ Instructions to installation

## ⚠ WARNING

- Its improper installation can also result in heat generation or fire.
- When setting up or moving the location of the air conditioner, do not mix air etc. or anything other than the designated refrigerant within the refrigeration cycle.
- Rupture and injury caused by abnormal high pressure can result from such mixing.
- Always use accessory parts and authorized parts for installation construction. Using parts not authorized by this company can result in water leakage, electric shock, fire and refrigerant leakage.

## ⚠ CAUTION

- Execute proper grounding. Do not connect the ground wire to a gas pipe, water pipe, lightning rod or a telephone ground wire. Improper placement of ground wires can result in electric shock.
- The installation of an earth leakage breaker is necessary depending on the established location of the unit. Not installing an earth leakage breaker may result in electric shock.
- Do not install the unit where there is a concern about leakage of combustible gas.
- The rare event of leaked gas collecting around the unit could result in an outbreak of fire.
- For the drain pipe, follow the installation manual to insure that it allows proper drainage and thermally insulate it to prevent condensation. Inadequate plumbing can result in water leakage and water damage to interior items.

## PRECAUTION

- Execute proper grounding. Do not connect the earth wire to a gas pipe, water pipe, lightning rod, or a telephone ground wire. Improper placement of earth wires can result in electric shock.
- An electric leakage breaker must be installed, otherwise electric shock or other accidents would occur.
- After completion of the installation, the air conditioner shall be electrified to check for electric leakage.

## 2. Preparation for installation

Installation tools

1	Screw Driver (flat head, wabblers, triangle)	8	Pipe Expander
2	Steel Saw	9	Knives
3	60mm Drill	10	Clippers
4	Inner Hexagon Spanner	11	Leakage Checker or Soap Liquid
5	Shifting Spanner	12	Measuring Tape
6	Spanner	13	Scraper or File
7	Pipe Cutter	14	Refrigeration Oil

# ■ Instructions to installation

## 3. Accessories for installation

Self-contained accessories

No.	A	B	C	D	E	F
Name of Parts	Non-adhesive Tape	Adhesive tape	Connecting Hose	Heat insulation material	Gypsum powder	Drain hose

## 4. Choose the installation place

- Install the indoor unit where the weight of the unit can be supported.
- Install the indoor unit where the heat source and steam source are not close and the unit inlet and outlet are not blocked.
- Install the indoor unit where the drainage is easy and the outdoor unit can be easily connected.
- Install the indoor unit where its cold air and hot air can be easily sent to all the corners of the room.
- Install the indoor unit where the power socket is near and there is sufficient space around the indoor unit.
- Install the indoor unit where there is no T.V set, radio set, and wireless appliance underneath, and the sunlight lamp is over one meter away.
- If the remote controller is installed on the wall, the indoor unit shall be ensured to receive the signal while the sunlight lamp is on.

## 5. Installation procedure

1. Drill a hole in the wall and insert the connecting pipe and wire through a PVC wall-through tube purchased locally. The wall hole shall be with a outward down slope of at least 1/100. (See Figure 1)
2. Before drilling check that there is no pipe or reinforcing bar just behind the drilling position. Drilling shall avoid at positions with electric wire or pipe.
3. Mount the unit on a strong and horizontal building roof. If the base is not firm, it will cause noise, vibration or pipe broken and refrigerant leakage (see Figure 6).
4. Support the unit firmly.
5. Change the form of the connection pipe, connection wire and drain pipe so that they can go through the wall hole easily.

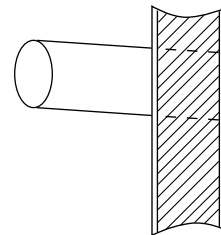
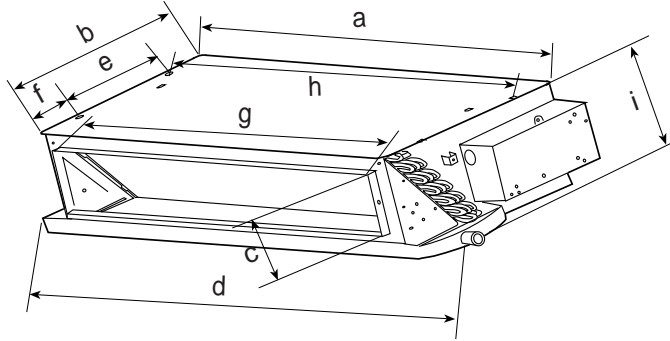

Fig 1



# ■ Instructions to installation



Installation dimension:(mm)

Unit model	a	b	c	d	e	f	g	h	i
AD092XLERA AD122XLERA	538	483.5	131	610	255	105	418	508	220
AD142XLERA AD182XLERA	1002	483.5	131	1105	255	105	880	970	220

## NOTE!

- 1.This series' indoor units are all low static pressure type(max. 20 Pa external static pressure available ).
- 2.An access port must be provided during installation of indoor unit for maintenance.

- When installing the ceiling concealed type indoor unit, a specially designed return air bellows shall be installed, as shown in Figure 3, Figure 4.

Figure 3

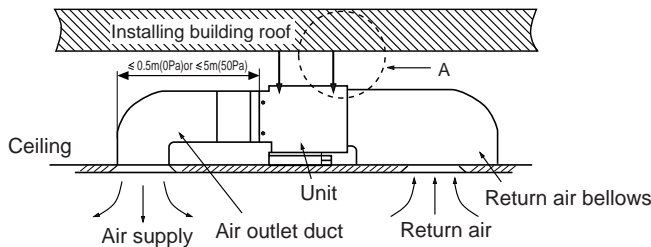
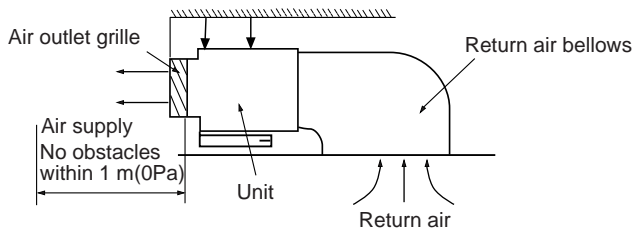

Figure 4



- Each air return and supply duct should fix to the floor precast slab by using an iron stand. Use glue to seal the interface closely. Recommend the distance between the air return duct and the wall is more than 150mm.

# ■ Instructions to installation

- The distance between air duct outlet and air conditioner outlet is according to the length of actually installed air duct and in service behavior of the static pressure terminal: Installation sketch map for long and short air duct is showed below, when connect to short air duct, using low static terminal (terminal color is white), the distance between air duct outlet and air conditioner outlet is no more than 0.5m; when connect to long air duct, using middle static terminal (terminal color is red), the distance between air duct outlet and air conditioner outlet could be within 5m at this point.

Figure 5

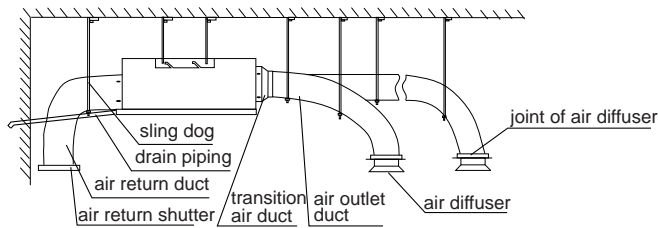

- Drain piping of condensed water should keep a downhill grade of 1% or more. Use insulating pipe to cover the drain piping of condensed water to keep warmth.
- As figure shown, suspend and install the unit.

Figure 6

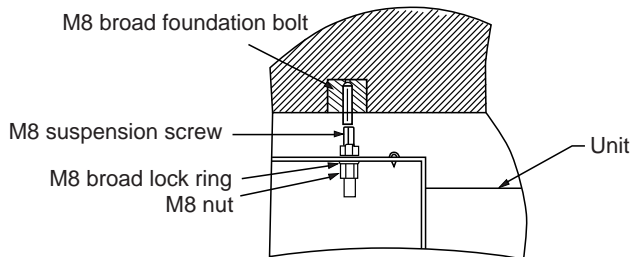

## Installation for air duct of indoor unit

### 1. Installation of air discharge duct

- This type of unit uses circular air duct with its caliber of 180mm.
- An additional transitive air duct is necessary for the circular air duct to connect to the air supply inlet. It should be also connected to its respective air diffuser separately. See Fig.1. Adjust the wind speed of each air diffuser outlet to keep in line on the whole, so as to meet a demand of the air conditioner in the room.

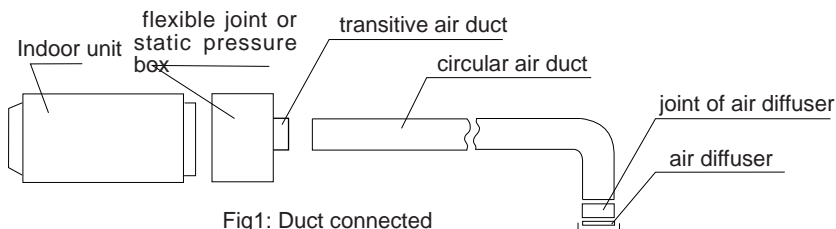

# ■ Instructions to installation

## 2. Installation of air return duct

Use rivets to connect the air return duct to the air return inlet of the indoor unit. The other end connects to the air return shutter. as shown in Fig.2.

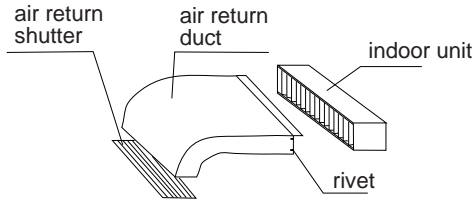

Fig2: Duct return connected

## 3. Air duct insulation

Insulation layer is needed for air supply and return duct. First, paste a glue nail to the air duct, and then attach the insulation cotton that has a tinfoil layer and use the glue nail cover to fix. Finally, seal the air duct interface with tinfoil adhesive tape closely. as shown in Fig3.

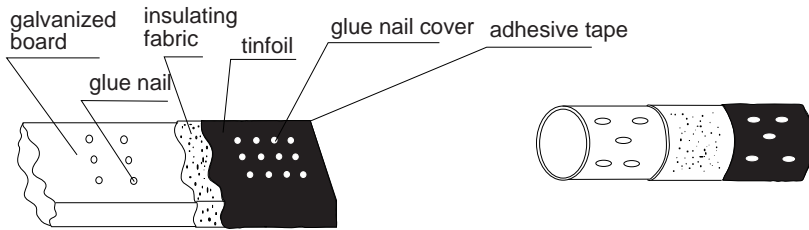

Fig3

### Installing the suspension screw

Use M8 or M10 suspension screws (4, prepared in the field) (when the suspension screw height exceeds 0.9 m, M10 size is the only choice). These screws shall be installed as follows with space adapting to air conditioner overall dimensions according to the original building structures.

#### Wooden structure

A square wood shall be supported by the beams and then set the suspension screws.

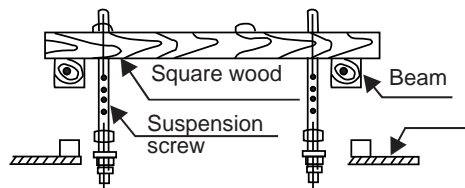

#### New concrete slab

To set with embedded parts, foundation bolts etc.



Knife embedded part



Guide plate embedded part

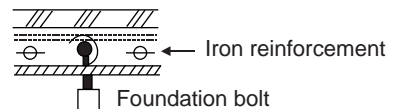

Pipe suspension foundation bolt

# ■ Instructions to installation

## Original concrete slab

Use hole hinge, hole plunger or hole bolt.

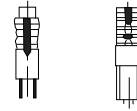

## Steel reinforcement structure

Use steel angle or new support steel angle directly.

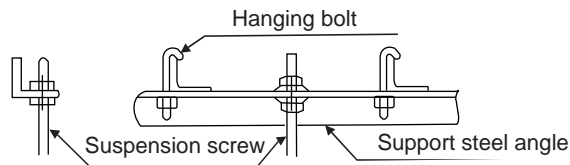

## Hanging of the indoor unit

Fasten the nut on the suspension screw and then hang the suspension screw in the Tslot of the suspension part of the unit.

Aided with a level meter, adjust level of the unit within 5 mm.

### ⚠ CAUTION

In order to drain water normally, the drain pipe shall be processed as specified in the installation manual and shall be thermal insulated to avoid dew generation. Improper hose connection may cause indoor water leakage.

## Requirements

- The indoor drain pipe shall be thermal insulated.
- The connection part between the drain pipe and the indoor unit shall be insulated so as to prevent dew generation.
- The drain pipe shall be slant downwards (greater than 1/100). The middle part shall not be of Stype elbow, otherwise abnormal sound will be produced.
- The horizontal length of the drain pipe shall be less than 20 m. In case of long pipe, supports shall be provided every 1.5 ñ 2m to prevent wavy form.
- Central piping shall be laid out according to the following figure.
- Take care not to apply external force onto the drain pipe connection part.

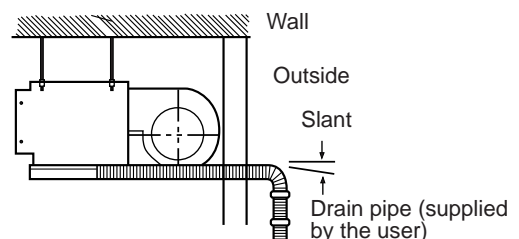
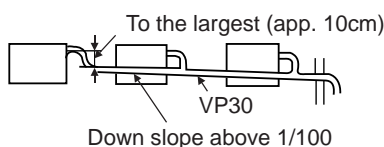
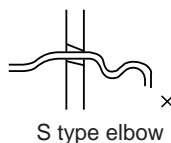
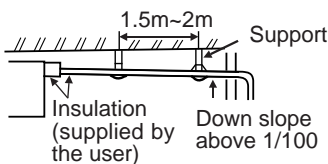

# ■ Instructions to installation

## Pipe and insulation material

Pipe	Rigid PVC pipe VP31.5mm (internal diameter)
Insulation	Foamed PE with thickness above 7mm

## Hose

Drain pipe size:  $\bar{y}$  19.05mm<sup>2</sup> (3/4") PVC pipe.

The hose is used for adjusting the off-center and angle of the rigid PVC pipe.

- Directly stretch the hose to install without making any deformation.
- The soft end of the hose must be fastened with a hose clamp.
- Please apply the hose on horizontal part

### Insulation treatment:

- Wrap the hose and its clamp until to the indoor unit without any clearance with insulating material, as shown in the figure.

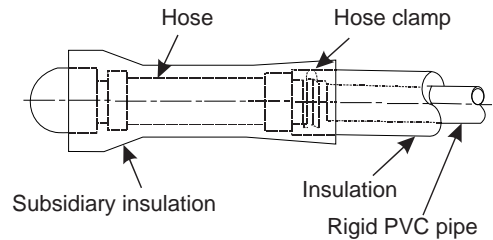

## Drain confirmation

During trial run, check that there is no leakage at the pipe connection part during water draining even in winter.

## Allowable pipe length and drop

These parameters differ according to the outdoor unit. See the instruction manual attached with the outdoor unit for details.

## Supplementary refrigerant

The refrigerant supplementation shall be as specified in the installation instructions attached with the outdoor unit. The added refrigerant shall be R22.

The adding procedure shall be aided with a measuring meter for a specified amount of supplemented refrigerant

### Requirement

Overfilling or underfilling of refrigerant will cause compressor fault. The amount of the added refrigerant shall be as specified in the instructions.

### Pipe cutting and expanding

If the pipe is too long or the flare is damaged, it needs to be cut or expanded.

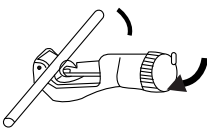

1. Pipe cutting



2. Removing burrs

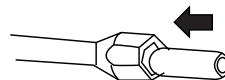

3. Insertion nut

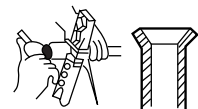

4. Pipe expansion

# ■ Instructions to installation

## Piping Connection

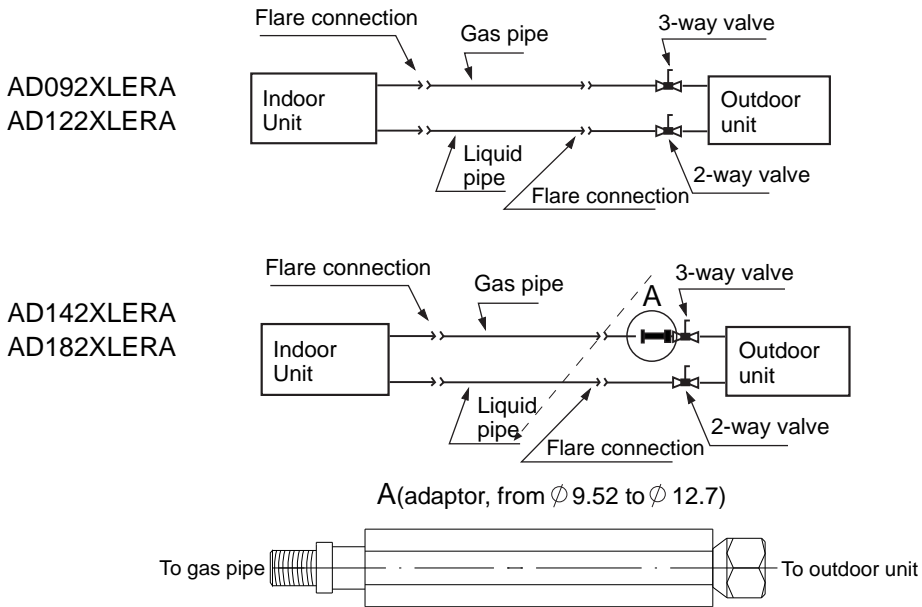

### Pipe expansion dimensions as follows:

Pipe diameter $\ddot{y}$	Size A (mm)
6.35 mm (1/4")	0.8 ~ 1.5
9.52 mm (3/8")	1.0 ~ 1.8
12.7 mm (1/2")	1.2 ~ 2.0

Correct	Incorrect				
	Slope	Damage	Bur	Partial	Overlong

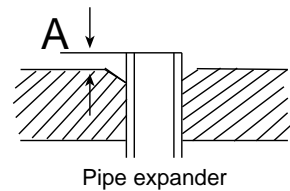

- The connection of indoor unit pipes must use double spanners.
- The installing torque shall be as given in the following table.

Connecting pipe O.D.(mm)	Installing torque (N-m)	Increased installing torque (N-m)
$\ddot{y}$ 6.35	11.8 (1.2kgf-m)	13.7 (1.4 kgf-m)
$\ddot{y}$ 9.52	24.5 (2.5kgf-m)	29.4 (3.0 kgf-m)
$\ddot{y}$ 12.70	49.0 (5.0 kgf-m)	53.9 (5.5 kgf-m)

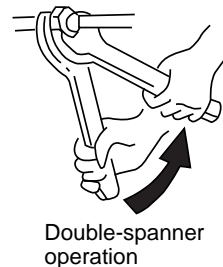

# ■ Instructions to installation

## 1. Indoor unit communication addresses setting

**CAUTION! FAIL TO DO THIS, THE UNIT WILL NOT WORK.**

This kind of indoor units can only set the address by using the Dip Switches.

(1). Please note that the address must be set as following:

- Indoor unit that connect to valve A, the address must be 1;
- Indoor unit that connect to valve B, the address must be 2;
- Indoor unit that connect to valve C, the address must be 3;
- Indoor unit that connect to valve D, the address must be 4;

(2). Address setting procedure when using the DIP switches SW01 and SW03.

A. The DIP switches SW01 and SW03 are on the indoor unit PCB.

B. Change the position of DIP 7 of SW01 from OFF to ON, if fail to do this, the addresses set by SW03 will not work.

C. Use SW03 to set the addresses as following (DO NOT CHANGE OTHER DIP SWITCHES):

SW01	SW03	INDOOR UNIT ADDRESS	OUTDOOR VALVE																																																
<table border="1" style="display: inline-table;"> <tr><td>1</td><td>2</td><td>3</td><td>4</td><td>5</td><td>6</td><td>7</td><td>8</td></tr> <tr><td></td><td></td><td></td><td></td><td></td><td></td><td style="background-color: black;"></td><td></td></tr> <tr><td></td><td></td><td></td><td></td><td></td><td></td><td></td><td></td></tr> </table> ON OFF	1	2	3	4	5	6	7	8																	<table border="1" style="display: inline-table;"> <tr><td>1</td><td>2</td><td>3</td><td>4</td><td>5</td><td>6</td><td>7</td><td>8</td></tr> <tr><td></td><td></td><td></td><td></td><td></td><td style="background-color: black;"></td><td style="background-color: black;"></td><td></td></tr> <tr><td></td><td></td><td></td><td></td><td></td><td></td><td></td><td></td></tr> </table> ON OFF	1	2	3	4	5	6	7	8																	1	A
1	2	3	4	5	6	7	8																																												
1	2	3	4	5	6	7	8																																												
	<table border="1" style="display: inline-table;"> <tr><td>1</td><td>2</td><td>3</td><td>4</td><td>5</td><td>6</td><td>7</td><td>8</td></tr> <tr><td></td><td></td><td></td><td></td><td></td><td style="background-color: black;"></td><td></td><td style="background-color: black;"></td></tr> <tr><td></td><td></td><td></td><td></td><td></td><td></td><td></td><td></td></tr> </table> ON OFF	1	2	3	4	5	6	7	8																	2	B																								
1	2	3	4	5	6	7	8																																												
	<table border="1" style="display: inline-table;"> <tr><td>1</td><td>2</td><td>3</td><td>4</td><td>5</td><td>6</td><td>7</td><td>8</td></tr> <tr><td></td><td></td><td></td><td></td><td></td><td style="background-color: black;"></td><td style="background-color: black;"></td><td></td></tr> <tr><td></td><td></td><td></td><td></td><td></td><td></td><td></td><td></td></tr> </table> ON OFF	1	2	3	4	5	6	7	8																	3	C																								
1	2	3	4	5	6	7	8																																												
	<table border="1" style="display: inline-table;"> <tr><td>1</td><td>2</td><td>3</td><td>4</td><td>5</td><td>6</td><td>7</td><td>8</td></tr> <tr><td></td><td></td><td></td><td></td><td></td><td style="background-color: black;"></td><td style="background-color: black;"></td><td style="background-color: black;"></td></tr> <tr><td></td><td></td><td></td><td></td><td></td><td></td><td></td><td></td></tr> </table> ON OFF	1	2	3	4	5	6	7	8																	4	D																								
1	2	3	4	5	6	7	8																																												

## 2. Installation check and trial operation

Check the Layout of the Drain Pipe and Connection Wires, and also the piping and address setting. The drain pipe should be placed underneath, and the connection wires should be placed upside; and the drain pipe especially the section inside the machine and indoors must be wound up with insulating material to preserve heat. The drain pipe shall be sloped and no concave and convex shall occur along the whole pipe. And the cases as the right figure indicates shall not occur.

## 3. Installation check

- Is power supply voltage required?
- Is water completely drained to outdoors?
- Are power wire and connection wires between indoor and outdoor units correctly connected?
- Is any gas leaked from the pipe connectors?
- Are series numbers of the terminals on the indoor and outdoor units corresponding to each other?
- Is the connection section of the auxiliary pipe insulated? Is the indoor unit fixed firmly?
- Is noise big?

# ■ Instructions to installation

## 4. Trial operation

The person who has completed this installation shall be requested to conduct a test operation for check:

Is the temperature adjuster working normally?

Does the location for installation conform to requirements?

Winding up with Protective Plastic Tape. The connection pipes, drain pipe, and the connection wires shall be wound up with PVC tape.

### NOTE!

The connection pipes shall also be wound up with insulating material to preserve the temperature. The airing direction shall be from bottom to top.

## Wiring methods:

### ① Wiring method of ring terminal

For connecting line which end is a ring, its wiring method as shown in the right figure: remove wiring screw and pass it through the end ring of connecting line, then connect it to the terminal block and tighten screw.

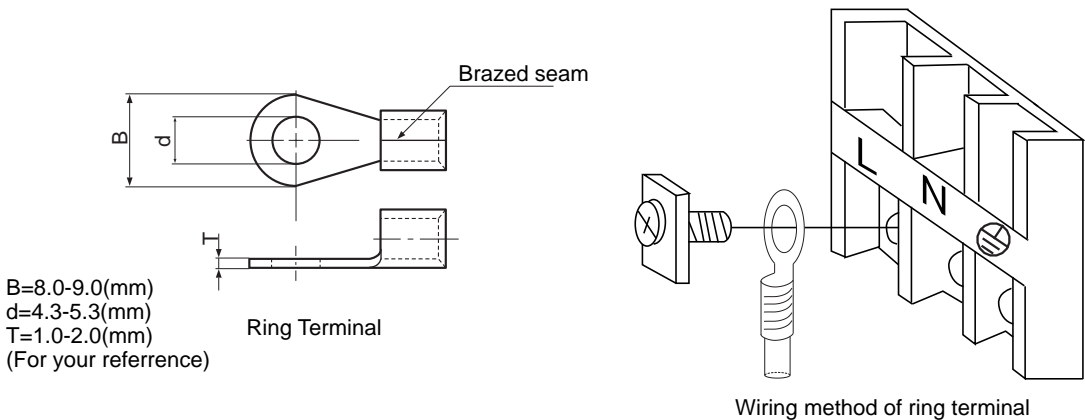

### ② Wiring method of straight terminal

For connecting line which end is not a ring, its wiring method as follows: loosen wiring screw and insert the end of connecting line totally into the terminal block, then tighten the screw and pull the connecting line slightly to confirm that it is clamped firmly.

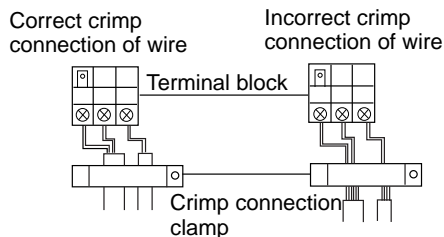

### ③ Crimp connection method of connecting line

After finishing wiring, connecting line must be fastened by wire clamp, which pressed on the external sheath of the connecting line, as shown in the right figure:



# ■ Instructions to installation

## ④ Wiring of indoor unit

The distance between the signal wires and the power cables should be at least 50mm.

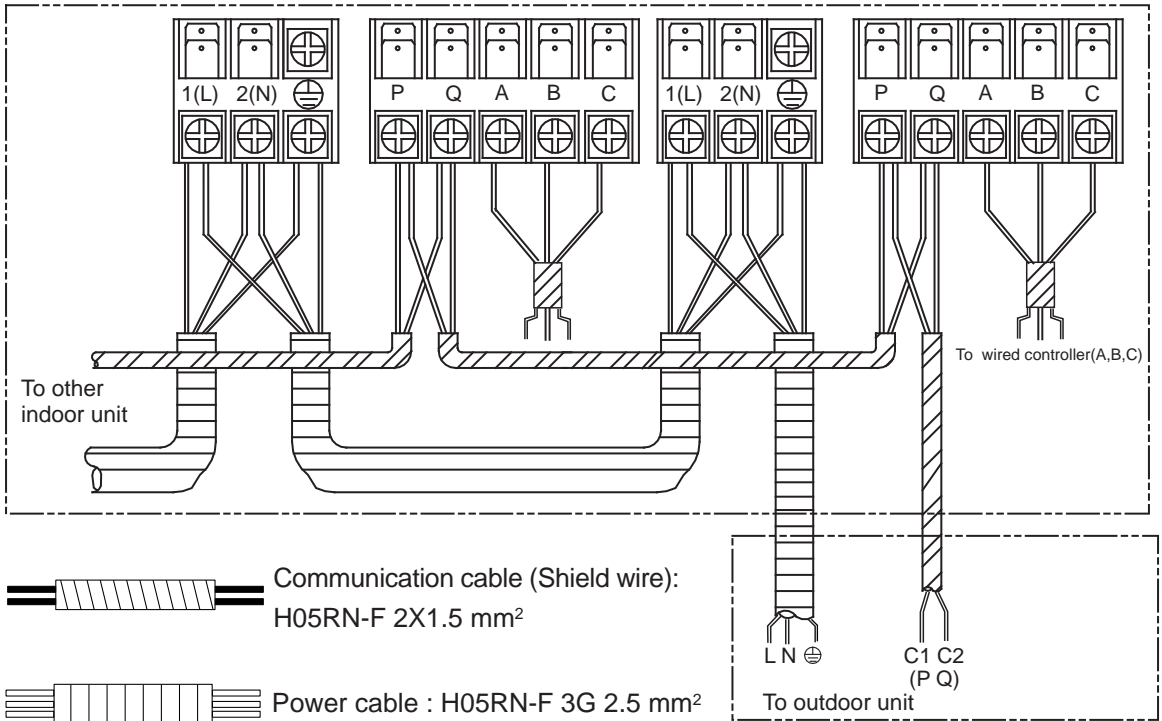

Warning:

1. Incorrect address setting will cause abnormal to the system.
2. Communication cable must be use sheilded type.

## Failure code

TROUBLE SHOOTING (indoor unit)	FAILURE CODE (CHECK THE WIRED REMOTE CONTROLLER)	POSSIBLE REASONS
Faulty temperature sensor <b>T<sub>ai</sub></b>	01 *	Sensor disconnected, or broken, or at wrong position, or short circuit
Faulty temperature sensor <b>T<sub>c1</sub></b>	02 *	Sensor disconnected, or broken, or at wrong position, or short circuit
Faulty temperature sensor <b>T<sub>c2</sub></b>	03 *	Sensor disconnected, or broken, or at wrong position, or short circuit
Faulty temperature sensor <b>T<sub>m</sub></b>	04 *	Sensor disconnected, or broken, or at wrong position, or short circuit
Faulty EEPROM on indoor unit PCB	05	Faulty indoor unit PCB
Abnormal communication between indoor and outdoor unit	06 *	Wrong connection, or the wires be disconnected, or wrong address setting of indoor units, or faulty power supply or faulty PCB

# ■ Failure code

<b>TROUBLE SHOOTING</b> (indoor unit)	<b>FAILURE CODE</b> (CHECK THE WIRED REMOTE CONTROLLER)	<b>POSSIBLE REASONS</b>
Abnormal communication between wired controller and indoor unit PCB	07 *	Wrong connection, or use the wired controller be disconnected, faulty PCB
Drainage system abnormal	08 *	The short-connector disconnected, or at wrong position, or the float switch broken down or the float switch disconnected, or at wrong position
Indoor unit address repeated	09	Wrong setting of indoor unit address
Abnormal communication between chip TMP/807 and chip TMP/846	0E	Faulty indoor unit PCB
<b>TROUBLE SHOOTING</b> (outdoor unit)	<b>FAILURE CODE</b> (CHECK THE WIRED REMOTE CONTROLLER)	<b>POSSIBLE REASONS</b>
Faulty defrost sensor <b>Te</b>	14 *	Sensor disconnected, or broken, or short circuit
Faulty sensor <b>Tao</b>	15 *	Sensor disconnected, or broken, or short circuit
Faulty sensor <b>Ts</b>	16 *	Sensor disconnected, or broken, or short circuit
Faulty sensor <b>Td</b>	17 *	Sensor disconnected, or broken, or short circuit
Input overcurrent	19	Over current of the system, or broken of the current sensor, or malfunction with indoor or outdoor fan motors, or faulty PCB.
System high pressure protection	1E *	High pressure switch is disconnected, or high pressure switch worked, or Tc too high and faulty outdoor fan motor when cooling, or faulty indoor fan motors when heating, or refrigerant overabundance
System low pressure protection	1F *	Low pressure switch is disconnected, or low pressure switch worked, or Te too low and faulty outdoor fan motors when heating, or faulty indoor fan motor when cooling, or refrigerant shortage
IPM protection	20	IPM over current, or short circuit, or IPM temperature too high, or IPM input voltage too low, or faulty SPDU (or ISPM).
EEPROM fault	21	Faulty outdoor unit PCB
Over hot protection of compressor	22	Serious lack of refrigerant of the system, or the ambient temperature too high, or PMVs be blocked
Over hot protection of SPDU (or ISPM)	23	Ambient temperature too high, or outdoor fan be blocked, or bad air circulation of outdoor unit
DC fan motor fault	24	Fan is blocked, or the terminal is disconnected from the PCB

# ■ Failure code

<b>TROUBLE SHOOTING (outdoor unit)</b>	<b>FAILURE CODE (CHECK THE WIRED REMOTE CONTROLLER)</b>	<b>POSSIBLE REASONS</b>
Faulty 4-way valve switching on	25	Coil of 4-way valve is disconnected, or faulty outdoor PCB
Faulty sensor <b>Tc</b>	26 *	Sensor disconnected, or broken, or short circuit
Faulty sensor <b>Toci</b>	2A *	Sensor disconnected, or broken, or short circuit
Low voltage protection	2C	VDC<194V, too low voltage from power source
High voltage protection	2D	VDC>400V, too high voltage from power source
Abnormal communication between main PCB and SPDU(or ISPM)	2E	Communication cables broken, or not be well connected, or faulty main PCB, or faulty SPDU (or ISPM)
Compressor be locked	32	Faulty compressor or SPDU(or ISPM)
Compressor vibration too big	33	Faulty compressor
Compressor lose position	34	Faulty SPDU(or ISPM)
Faulty compressor start	35	Faulty compressor or SPDU(or ISPM)
Faulty position checking circuit	37	Faulty SPDU(or ISPM)
Compressor broken	38	Faulty compressor or SPDU(or ISPM)

## NOTE!

1. Please contact the installers or distributors when trouble happens to repair it.
2. Turn the power off and power on again, if the failure code recurs, please inform the franchiser.
3. Failure codes marked with \* are resumable.

**HAIER GROUP**

Qingdao Haier Air Conditioner Electric Co., Ltd.

Address: Haier Garden, Qianwangang Road, Economic Development Zone,  
Qingdao, Shandong 266555, P.R.China

Web Site: <http://www.haier.com>