

CONVERTIBLE TYPE AIR CONDITIONER

Operation & Installation Manual

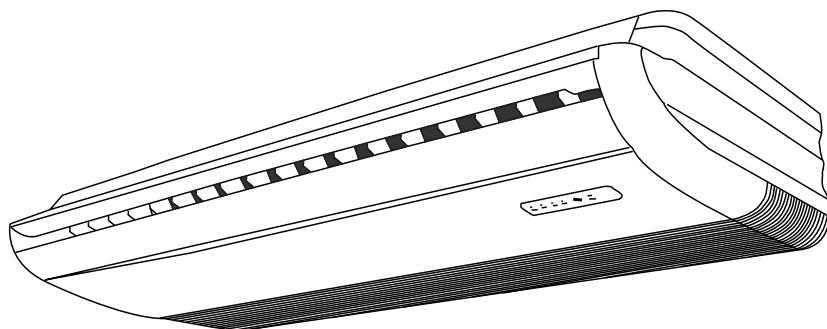

| | |
|------------|------------|
| AC282AFEAA | AC282AFERA |
| AC362AFEAA | AC362AFERA |
| AC482AFEAA | AC522AFERA |
| AC602AFEAA | |

No. 0010577967

A

- Please read this operation manual before using the air conditioner.
- Please keep this manual carefully and safely.

■ Contents

| | |
|-----------------------------------|-------|
| Cautions | 1-2 |
| Safety Precautions | 3-4 |
| Features and Functions | 5-7 |
| Name of Parts | 8 |
| Cleaning and Care | 9 |
| Operation Tips..... | 10 |
| Installation of Indoor Unit | 11-24 |
| Trouble Shooting..... | 25-28 |

■ Cautions

Disposal of the old air conditioner

Before disposing an old air conditioner that goes out of use, please make sure it's inoperative and safe. Unplug the air conditioner in order to avoid the risk of child entrapment.

It must be noticed that air conditioner system contains refrigerants, which require specialized waste disposal. The valuable materials contained in a air conditioner can be recycled. Contact your local waste disposal center for proper disposal of an old air conditioner and contact your local authority or your dealer if you have any question. Please ensure that the pipework of your air conditioner does not get damaged prior to being picked up by the relevant waste disposal center, and contribute to environmental awareness by insisting on an appropriate, anti-pollution method of disposal.

Disposal of the packaging of your new air conditioner

All the packaging materials employed in the package of your new air conditioner may be disposed without any danger to the environment.

The cardboard box may be broken or cut into smaller pieces and given to a waste paper disposal service. The wrapping bag made of polyethylene and the polyethylene foam pads contain no fluorochloric hydrocarbon.

All these valuable materials may be taken to a waste collecting center and used again after adequate recycling.

Consult your local authorities for the name and address of the waste materials collecting centers and waste paper disposal services nearest to your house.

Safety Instructions and Warnings

Before starting the air conditioner, read the information given in the User's Guide carefully. The User's Guide contains very important observations relating to the assembly, operation and maintenance of the air conditioner.

The manufacturer does not accept responsibility for any damages that may arise due to non-observation of the following instruction.

- Damaged air conditioners are not to be put into operation. In case of doubt, consult your supplier.
- Use of the air conditioner is to be carried out in strict compliance with the relative instructions set forth in the User's Guide.
- Installation shall be done by professional people, don't install unit by yourself.
- For the purpose of safety, the air conditioner must be properly grounded in accordance with specifications.
- Always remember to unplug the air conditioner before opening inlet grill. Always grip plug firmly and pull straight out from the outlet.

■ Cautions

- All electrical repairs must be carried out by qualified electricians. Inadequate repairs may result in a major source of danger for the user of the air conditioner.

- Do not damage any parts of the air conditioner that carry refrigerant by piercing or perforating the air conditioner's tubes with sharp or pointed items, crushing or twisting any tubes, or scraping the coatings off the surfaces. If the refrigerant spurts out and gets into eyes, it may result in serious eye injuries.

- Do not obstruct or cover the ventilation grille of the air conditioner. Do not put fingers or any other things into the inlet/outlet and swing louver.

- Do not allow children to play with the air conditioner. In no case should children be allowed to sit on the outdoor unit.

Specifications

- The refrigerating circuit is leak-proof.
- For this model, the all-pole disconnection method should be applied in the power supply.
- Such means for disconnection must be incorporated in the fixed wiring.

Temperature and Humidity Range

*.EAA :

| | | | Rated | Maximum | Minimum |
|---------|---------|-------|-------|---------|---------|
| Cooling | Indoor | DB °C | 27 | 32 | 18 |
| | | WB °C | 19 | 23 | 14 |
| | outdoor | DB °C | 35 | 43 | 10 |
| | | WB °C | 24 | 26 | -- |
| Heating | Indoor | DB °C | 20 | 27 | 15 |
| | | WB °C | 14.5 | -- | -- |
| | outdoor | DB °C | 7 | 24 | -7 |
| | | WB °C | 6 | 18 | -- |

*.ERA :

| | | | Rated | Maximum | Minimum |
|---------|---------|-------|-------|---------|---------|
| Cooling | Indoor | DB °C | 27 | 32 | 18 |
| | | WB °C | 19 | 23 | 14 |
| | outdoor | DB °C | 35 | 43 | -5 |
| | | WB °C | 24 | 26 | -- |
| Heating | Indoor | DB °C | 20 | 27 | 15 |
| | | WB °C | 14.5 | -- | -- |
| | outdoor | DB °C | 7 | 24 | -15 |
| | | WB °C | 6 | 18 | -- |

- If the air conditioner is used under higher temperature condition than those listed, the built-in protection circuit may operate to prevent internal circuit damage. Also, during Cooling and Dry modes, if the unit is used under conditions of lower temperature than those listed above, the heat-exchanger may freeze, leading to water leakage and other damage.
- Do not use this unit for any other purposes except for the Cooling and the Heating, Dehumidifying, and air-circulation of rooms should be in ordinary dwellings.
- The wiring method should be in line with the local wiring standard.
- The waste battery should be disposed properly.
- If the fuse on PC board is broken, please change it with the type T 3.15A/250VAC. The air breaker should be all-pole switch. and the distance between it's two contacts should no less than 3mm.

■ Safety Precautions

⚠ WARNING!

- The breaker of the air conditioner should be all-pole switch; and the distance between its two contacts should be no less 3 mm. Such means for disconnection must be incorporation in the fixed wiring.
- Use copper wire only. All the cables shall have got the European authentication certificate.
- The power supply connects from the outdoor side. The connecting cable and the power cable are self-provided.
- The parameter of connecting cable: H05RN-F 4G 0.75mm².
- The parameter of Indoor and Outdoor unit: T3.15A/250VAC. If the fuse on PC board is broken, please change with the type.

⚠ DANGER!

- Do not attempt to install this air conditioner by yourself.
- This unit contains no user-serviceable parts. Always consult authorized service personnel for repairs.
- When moving, consult authorized service personnel for disconnection and installation of the unit.
- Do not become excessively chilled by staying for lengthy periods in the direct cooling airflow.
- Do not insert fingers or objects into the outlet port or intake grills.
- Do not start and stop air conditioner operation by connecting and disconnecting the power supply cord and so on.
- Take care not to damage the power supply cord. If the supply cord is damaged, it must be replaced by the manufacturer or authorized service agent in order to avoid a hazard.
- In the event of a malfunction (burning smell, etc.), stop operation immediately, turn off the circuit breaker, and consult authorized service personnel.

■ Safety Precautions

⚠ WARNING!

- Provide occasional ventilation during use.
- Do not direct air flow at fire places or heating apparatuses.
- Do not climb on and place objects on the air conditioner.
- Do not hang objects from the indoor unit.
- Do not set flower vases or water containers on top of the air conditioner.
- Do not expose the air conditioner directly to water.
- Do not operate the air conditioner with wet hands.
- Do not pull power supply cord.
- Turn off power source when not using the unit for extended periods.
- Check the condition of the installation stand for damage.
- Do not place animals or plants in the direct path of the air flow.
- Do not drink the water drained from the air conditioner.
- Do not use in applications involving the storage of foods, plants or animals, precision equipment, or art works.
- Do not apply any heavy pressure to radiator fins.
- Operate only with air filters installed.
- Do not block or cover the intake grill and outlet port.
- Ensure that any electronic equipment is at least one metre away from either the indoor or outdoor unit.
- Avoid installing the air conditioner near a fireplace or other heating apparatuses.
- When installing the indoor and outdoor unit, take precautions to prevent access to infants.
- Do not use inflammable gases near the air conditioner.

■ Features and Functions

AUTOMATIC OPERATION

- **COOLING TYPE**

Merely press the ON/OFF button, and the unit will begin automatic operation in the Cooling or dry modes as appropriate, in accordance with the thermostat setting and the actual temperature of the room.

- **HEAT & COOL TYPE**

Merely press the ON/OFF button, and the unit will begin automatic operation in any of the Heating, Cooling and Blow modes as appropriate, in accordance with the thermostat setting and the actual temperature of the room.

SLEEP

- **COOLING TYPE**

When the SLEEP button is pressed during Cooling or Dry mode, the thermostat setting gradually rises during the period of operation. When the set time is reached, the unit automatically turns off.

- **HEAT & COOL TYPE**

When the SLEEP button is pressed during Heating mode, the air conditioner's thermostat setting gradually lowers during the period of operation; When the set time is reached, the unit automatically turns off.

WIRELESS REMOTE CONTROL UNIT

- The WIRELESS REMOTE CONTROL UNIT allows convenient control of air conditioner operation. For this type unit, the wireless remote controller type is YR-H50.

MILDEW-RESISTANT FILTER

- The AIR FILTER has been treated to resist mildew growth, thus allowing cleaner use and easier care.

■ Features and Functions

VERTICAL AIR DIRECTION ADJUSTMENT

Press the AIR FLOW DIRECTION VERTICAL SET button.

- Each time the button is pressed, the air direction range will change as follows:
Cool/Dehumidification/Fan:



Heat:

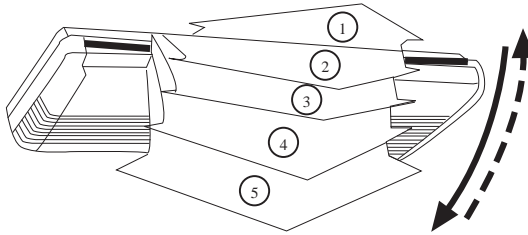
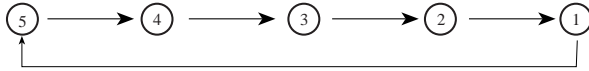

- Use the air direction adjustment within the ranges shown above.
- The vertical airflow direction is set automatically as shown, in accordance with the type of operation selected.

HORIZONTAL AIR DIRECTION ADJUSTMENT

Press the AIR FLOW DIRECTION HORIZONTAL SET button.

- Use the air direction adjustments within the ranges shown above.

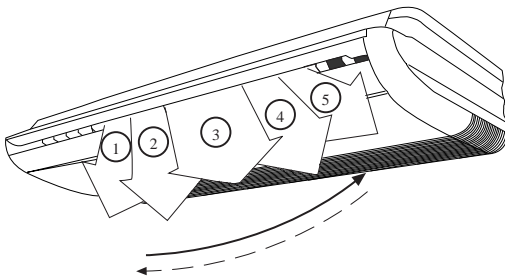

■ Features and Functions

- The swing range of up-down flap is as follow :

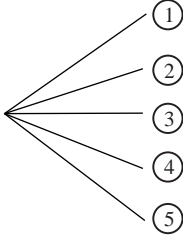

| Air flow direction set | Range of swing |
|------------------------|--------------------|
| ① | ① to ③ |
| ② | ① to ③ |
| ③ | ② to ④ |
| ④ | ③ to ⑤ |
| ⑤ | ① to ⑤ (all range) |

- Each time the button is pressed, the air direction range will change as follows:

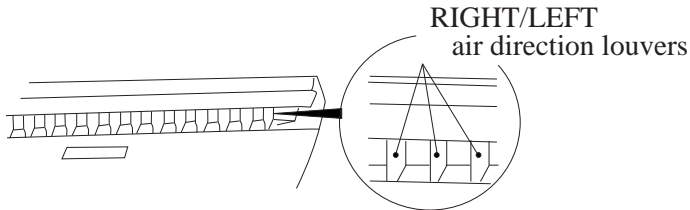
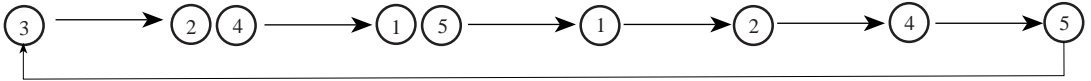

Note :

When being switched on firstly, the up-down flap will be at the position of max.angle. In cooling, the up-down louver is not good to stay at position 4, 5 for along time, otherwise, the dew will occur.

■ Name of Parts

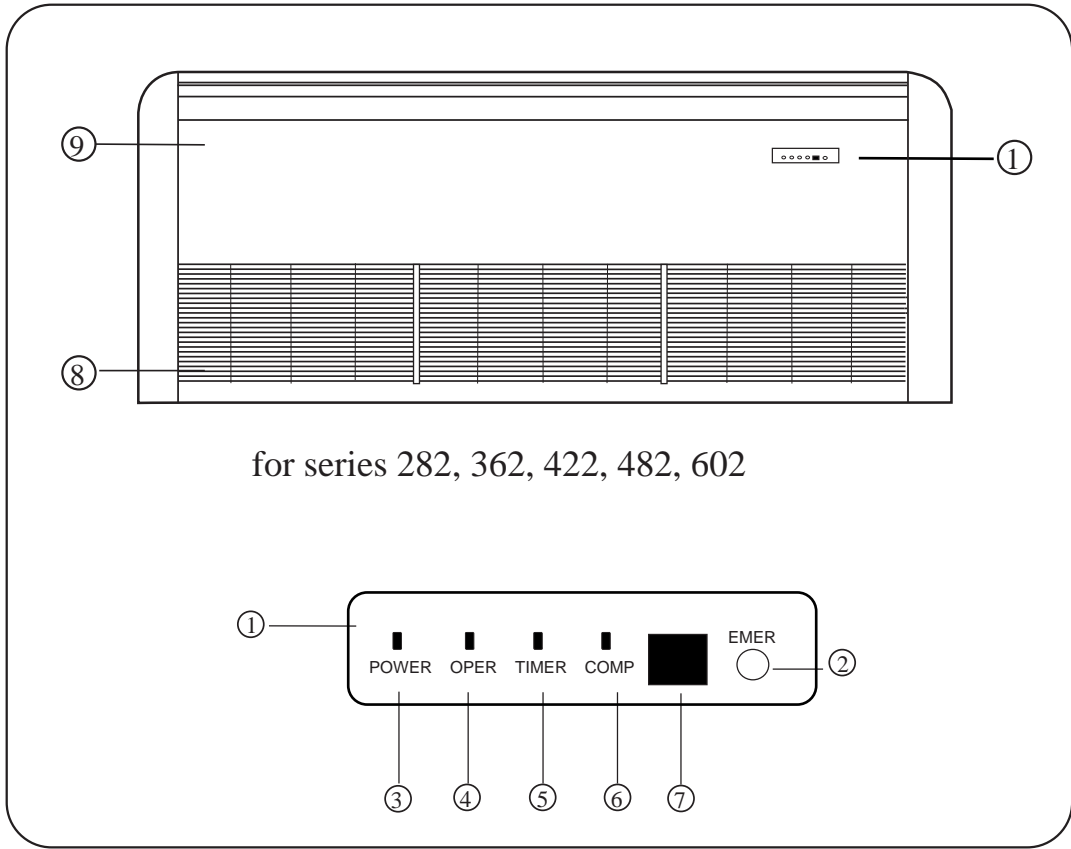

for series 282, 362, 422, 482, 602

- ① Operating Control Panel
- ② Emergency switch
- ③ Power Indicator Lamp
- ④ OPERATION Indicator Lamp
- ⑤ TIMER Indicator Lamp
- ⑥ Compressor Lamp
- ⑦ Remote receiver
- ⑧ Inlet Grill (Filter inside)
- ⑨ Front panel

■ Cleaning and Care

The following four procedures are for series 282, 362, 422, 482, 602.

1. Pull the filters upward to remove them from the Intake Grill.

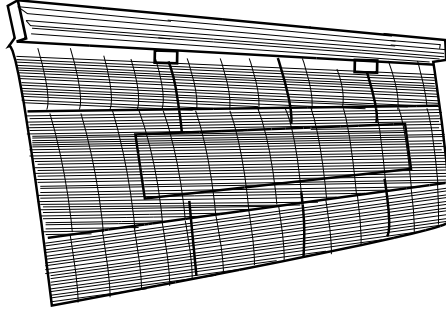

2. Clean the air filter: Remove the dust from the filters by vacuum cleaner or washing them. After washing, allow the air filters to dry thoroughly in an area protected from sunlight.
3. Re-attach the air filters to the Intake Grill, press the two buttons on the filters, until you hear a sound of click.

- When used for extended periods, the unit may accumulate dirt inside, which reduces its performance. We recommend that the unit is inspected regularly, in addition to your own cleaning and care. For more information, consult authorized service personnel.
- When cleaning the unit's body, do not use water hotter than 40°C, harsh abrasive cleansers, or volatile agents like benzene or thinner.
- Do not expose the unit body to liquid insecticides or hairsprays.
- When shutting down the unit for one month or more, first allow the Fan mode to operate continuously for about half a day to allow internal parts to dry thoroughly.

■ Operation Tips

Operation and Performance

*Heating Performance

- This air conditioner operates on the heat-pump principle, absorbing heat from outdoor air and transferring that heat indoors. As a result, the operating performance is reduced as outdoor air temperature drops. If you feel that insufficient heating performance is being produced, we recommend you use this air conditioner in conjunction with another kind of heating appliance.
- Heat-pump air conditioners heat your entire room by recirculating air throughout the room, with the result that some time may be required after first starting the air conditioner until the room is heated.

Instructions relating to heating (*) are applicable only to "HEAT & COOL TYPE".

*Microcomputer-controlled Automatic Defrosting

- When using the Heating mode under conditions of low outdoor air temperature high humidity, frost may form on the outdoor unit, resulting in reduced operating performance.
- In order to prevent this kind of reduced performance, this unit is equipped with a Microcomputer-controlled Automatic Defrosting function. If frost forms, the air conditioner will temporarily stop, and the defrosting circuit will operate briefly (for about 7 to 15 minutes).

STANDARD PARTS

The following installation parts are furnished. Use them as required.

Optional parts

| Mark | Parts name |
|------|--------------------------|
| Ⓐ | Adhesive tape |
| Ⓑ | Saddle (L.S) with screws |
| Ⓒ | Drain hose |
| Ⓓ | Heat insulation material |
| Ⓔ | Piping hole cover |
| Ⓕ | Putty |
| Ⓖ | Plastic clamp |

■ Installation of Indoor Unit

Please ask the dealer or specialist to install, never try by the users themselves. After the installation please be sure of the following conditions.

WARNING !

- **Please call dealer to install the air-conditioner.**
Incorrect installation may cause water leaking, shock and fire hazard.

CAUTION !

- **Air-conditioner can't be installed in the environment with inflammable gases because the inflammable gases near to air-conditioner may cause fire hazard.**
- **Installed electrical-leaking circuit breaker.**
It easily cause electrical shock without circuit breaker.
- **Connect earthing wire.**
Earthing wire should not be connected to the gas pipe, water pipe, lightning rod or phone line, incorrect earthing may cause shock.  Earthing
- **Use discharge pipe correctly to ensure efficient discharge.**
Incorrect pipe use may cause water leaking.

[Location]

- Air-conditioner should be located in well-vented and easily-accessible place.
- Air-conditioner should not be located in the following places:
 - (a) Places with machine oils or other oil vapours.
 - (b) Seaside with high salt content in the air.
 - (c) Near to hot spring with high content of sulfide gases.
 - (d) Area with frequent fluctuation of voltage e.g. factory, etc.
 - (e) In vehicles or ships.
 - (f) Kitchen with heavy oil vapour or humidity.
 - (g) Near to the machine emitting electric-magnetic waves.
 - (h) Places with acid, alkali vapour.
- TV, radio, acoustic appliances, etc. are at least 1 m far away to the indoor unit, outdoor unit, power

- supply wire, connecting wire, pipes, otherwise images may be disturbed or noises be created.
- As required, take measures against heavy snow.

[Wiring]

- Air-conditioner should be equipped with special power supply wire.

[Operating noise]

- Choose the following locations:
 - (a) Capable of supporting air-conditioner weight, don't increase operating noise and vibration.
 - (b) Hot vapour from outdoor unit outlet and operating noise don't disturb neighbour.
- No obstacles around the outdoor unit outlet.

■ Installation of Indoor Unit

For authorized service personnel only

WARNING

- (1) For the room air conditioner to operate satisfactorily, install it as outlined in this installation manual.
- (2) Connect the indoor unit and outdoor unit with the room air conditioner piping and cords available from our standard parts. This installation manual describes for the correct connections so that the installation set available from our standard parts should be used.
- (3) Installation work must be performed in accordance with national wiring standards by authorized personnel only.
- (4) Never cut the power cord, lengthen or shorten the cord, or change the plug.
- (5) Also, do not use an extension cord.
- (6) Plug in the power cord plug firmly. If the receptacle is loose, repair it before using the room air conditioner.
- (7) Do not turn on the power until all installation work is done.
 - Be careful not to scratch the room air conditioner when handling it.
 - After installation, explain correct operation to the customer, according to the operating manual.
 - Let the customer keep this installation manual because it will be used when the room air conditioner is serviced or moved.

1. SELECTING THE MOUNTING POSITION

WARNING

- Install at a place that can withstand the weight of the indoor unit and install it positively so that the unit will not topple or fall.

CAUTION

- Do not install the unit where there is the danger of combustible gas leakage.
- Do not install near heat sources.
- If children under 10 years old may approach the unit, take preventive measures so that they cannot reach the unit.

■ Installation of Indoor Unit

- (1) Install the indoor unit level on a strong wall which is not subject to vibration.
 - (2) The inlet and outlet ports should not be obstructed : the air should be able to blow all over the room.
 - (3) Do not install the unit where it will be exposed to direct sunlight ,
 - (4) Install the unit where connection to the outdoor unit is easy.
 - (5) Install the unit where the drain pipe can be easily installed.
 - (6) Take servicing , etc.into consideration and leave the spaces shown in (Fig.1 or 2) .
- Also install the unit where the filter can be removed .

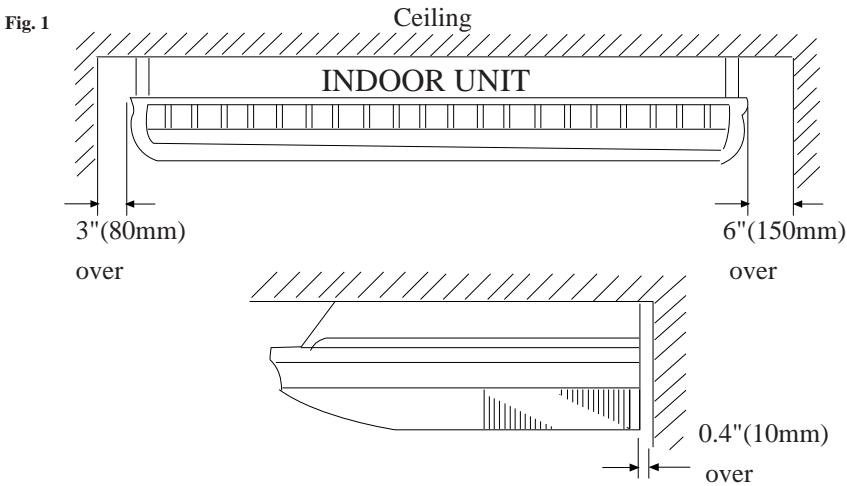

FOR HALF CONCEALED INSTALLATION

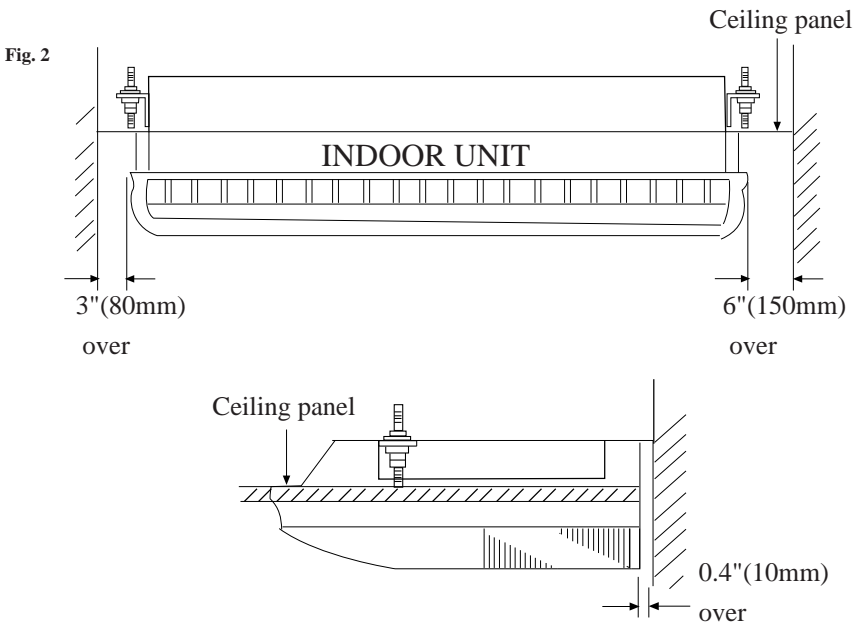

Installation of Indoor Unit

CONNECTION PIPE REQUIREMENT

Table 1

| Model | Diameter | | Maximum length | Maximum height (between indoor and outdoor) |
|--------------------------|-------------|----------|----------------|---|
| | Liquid side | Gas side | | |
| For series 522, 482, 602 | 9.52 mm | 19.05mm | 50 m | 30 m |
| For series 282, 362 | 9.52 mm | 15.88mm | 30 m | 150 m |

INSTALLATION PROCEDURE

Install the room air conditioner as follows:

1. REMOVE THE INTAKE GRILL AND SIDE COVER

- (1) Remove the Air filters
- (2) Remove the intake grilles
- (3) Remove the Side cover A (Right and left side)
- (4) This air conditioner can be set up to intake fresh air . For information about how to install for fresh-air intake, refer to page 22 "FRESH-AIR INTAKE".

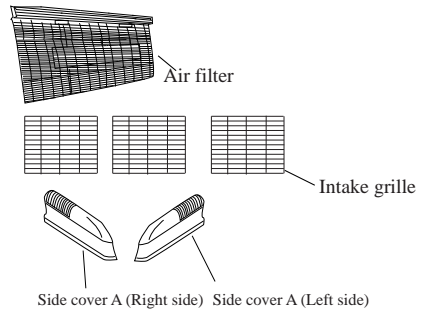

2. LOCATION OF CEILING SUSPENSION BOLTS

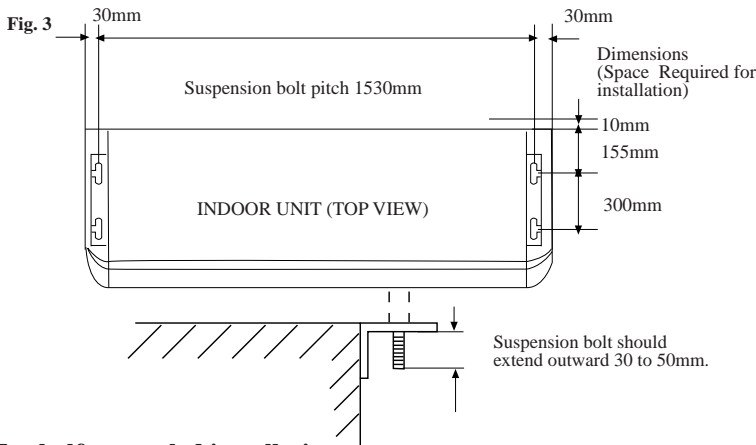

For half-concealed installation

Suspension-bolt pitch should be as shown in Fig.4.

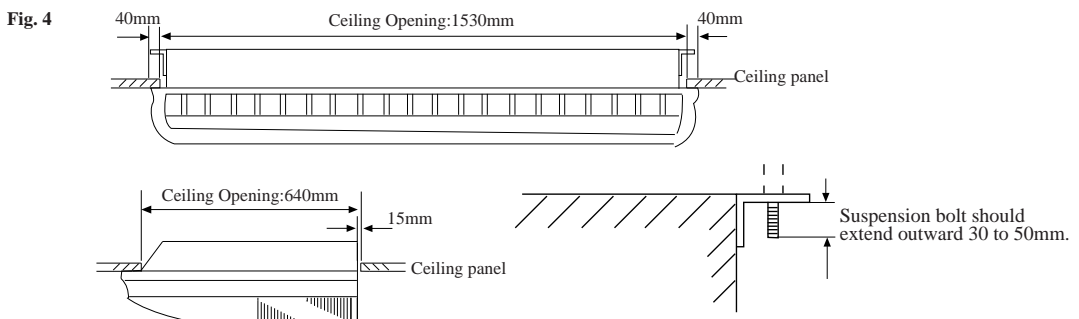

■ Installation of Indoor Unit

3. DRILLING THE HOLES AND ATTACHING THE SUAPENSION BOLTS

- (1) Drill **25mm holes at the suspension-bolt locations.
(The two special nuts are provided with the unit. The M10 nut must be obtained locally.)
Refer to Fig.5.
- (2) Install the bolts, then temporarily attach Special nuts A and B and a normal M10 nut to each bolt.

Fig. 5

| | |
|---------------|--------------------------------|
| Bolt Strength | 980 to 1470 N (100 TO 150 kgf) |
|---------------|--------------------------------|

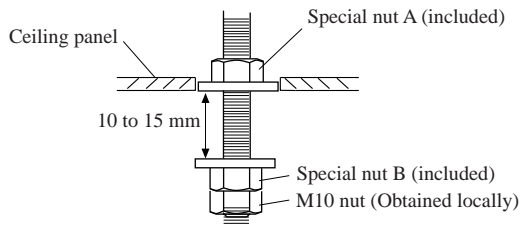

IF USING ANCHOR BOLTS

- (1) Drill holes for anchor bolts at the locations at which you will set the suspension bolts.
Note that anchor bolts (to be obtained locally).
- (2) Install the anchor bolts ,then temporarily attach special nut "B" (included) and a locally-procurde M10 nut to each of the bolts. (See Fig.6.)

Fig. 6

| | |
|----------------------|--------------------------------|
| Anchor-Bolt Strength | 980 to 1470 N (100 to 150 kgf) |
|----------------------|--------------------------------|

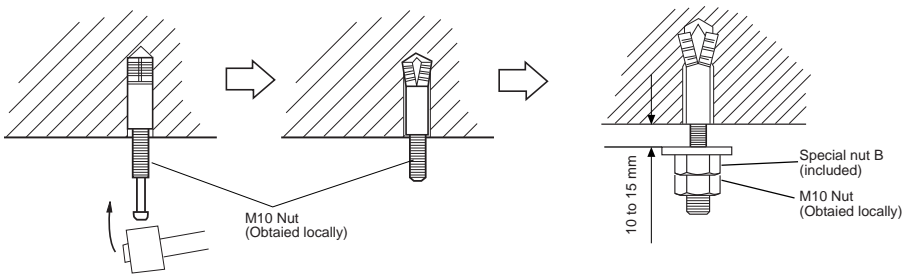

INSTALLING THE INDOOR UNIT

- (1) Lift unit so that suspension bolts pass through suspension fittings at the sides (four places),and slide the unit back.(See Fig.8.)

■ Installation of Indoor Unit

Fig. 7

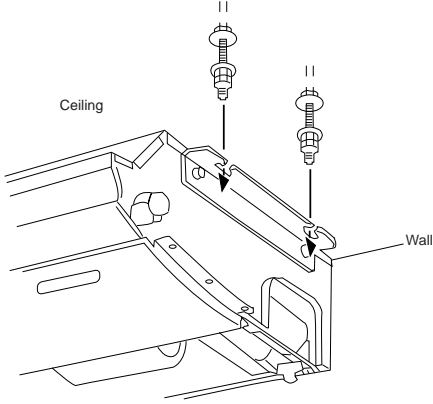
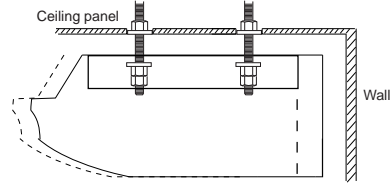

Fig. 8



(2) Fasten the indoor unit into place by tightening-up the special "B",blots and the M10 nuts. Make sure that unit is secure and willll not shift back and forth.

FOR HALF-CONCESLED INSTALLATION

When installing the indoor unit in a semi-concesled orientation, make sure to reinforce the insulation of the unit on all sides. Drops of water may fall from the unit if it is not thoroughly insulated.

Fig. 9

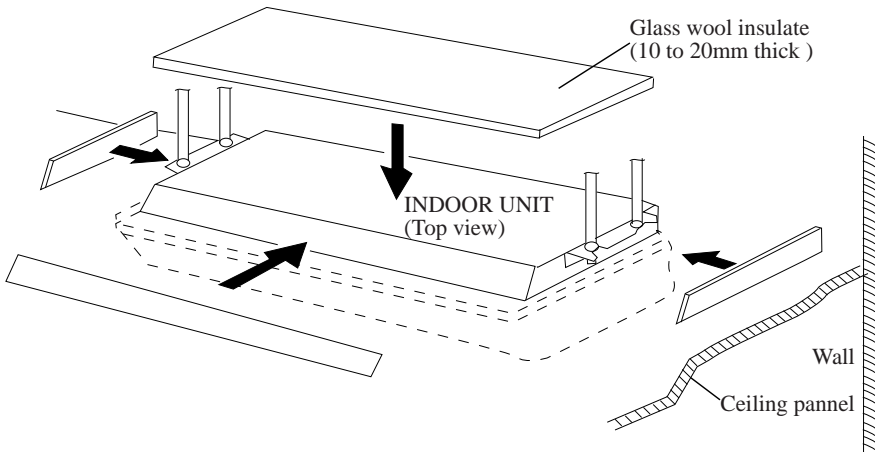

⚠ CAUTION

In order to check the drainage, be sure to use a level during installation of the indoor unit. If the installation site of the indoor unit is not level, water leskage may occur

■ Installation of Indoor Unit

INSTALLING THE COUPLER HEAT INSULATION

After checking for gas leaks, insulate by wrapping insulation around the two parts (large and small) of the indoor unit coupling, using the coupler heat insulation.

After installing the coupler heat insulation, wrap both ends with vinyl tape so that there is no gap.

Secure both ends of the heat insulation material using nylon fasteners.

Fig. 10

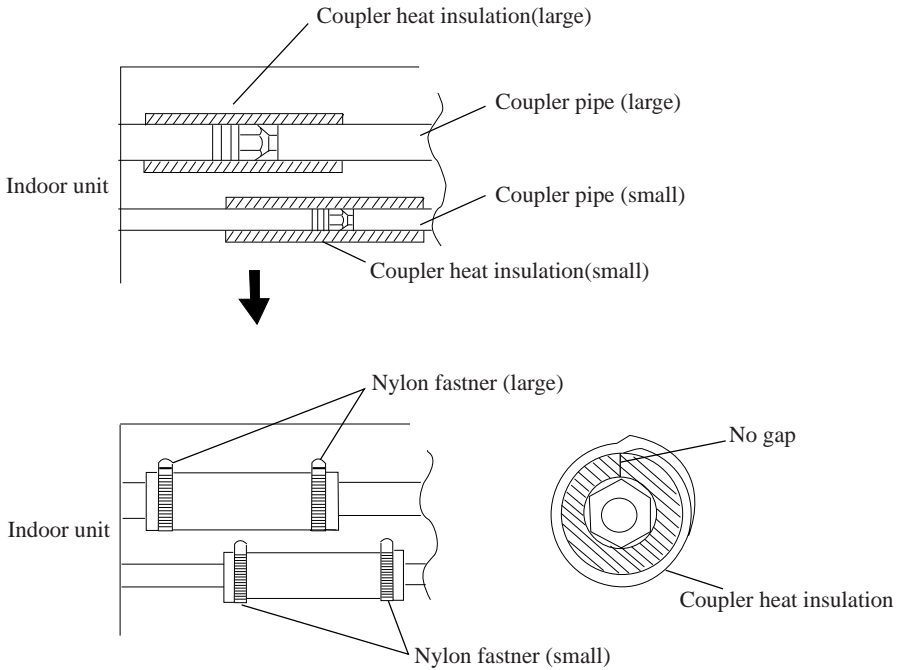

When using an auxiliary pipe, make sure that the fastener used is insulated in the same way.

⚠ Notice

When installing the unit on the floor, fix the four rubber base feet in the accessories on the bottom plate of the unit with four 4x16 screws and 4 flat washers, as the position in the figure.

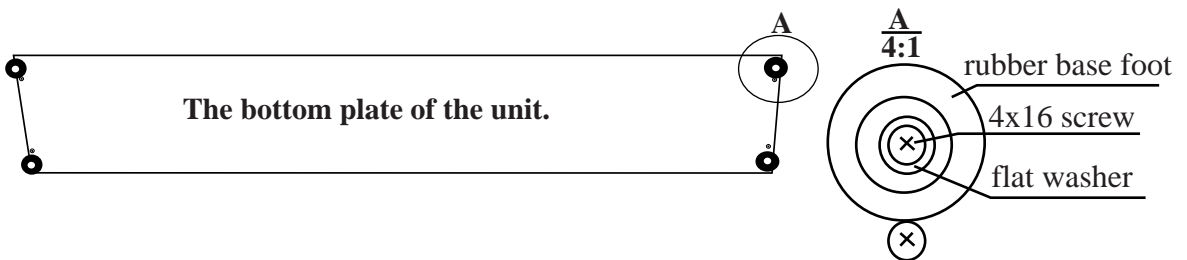

■ Installation of Indoor Unit

DRAIN PIPING

Install the drain pipe with downward gradient (1/50 to 1/100) and so there are no rises or traps in the pipe.

Use general hard polyvinyl chloride pipe (VP25)[outside diameter 38 mm.]

During installation of the drain pipe, be careful to avoid applying pressure to the drain point of the unit.

When the pipe is long, install supporters(Fig 11).

Do not perform air bleeding.

Always heat insulate (8mm or over thick) the indoor side of the drain pipe.

Fig. 11

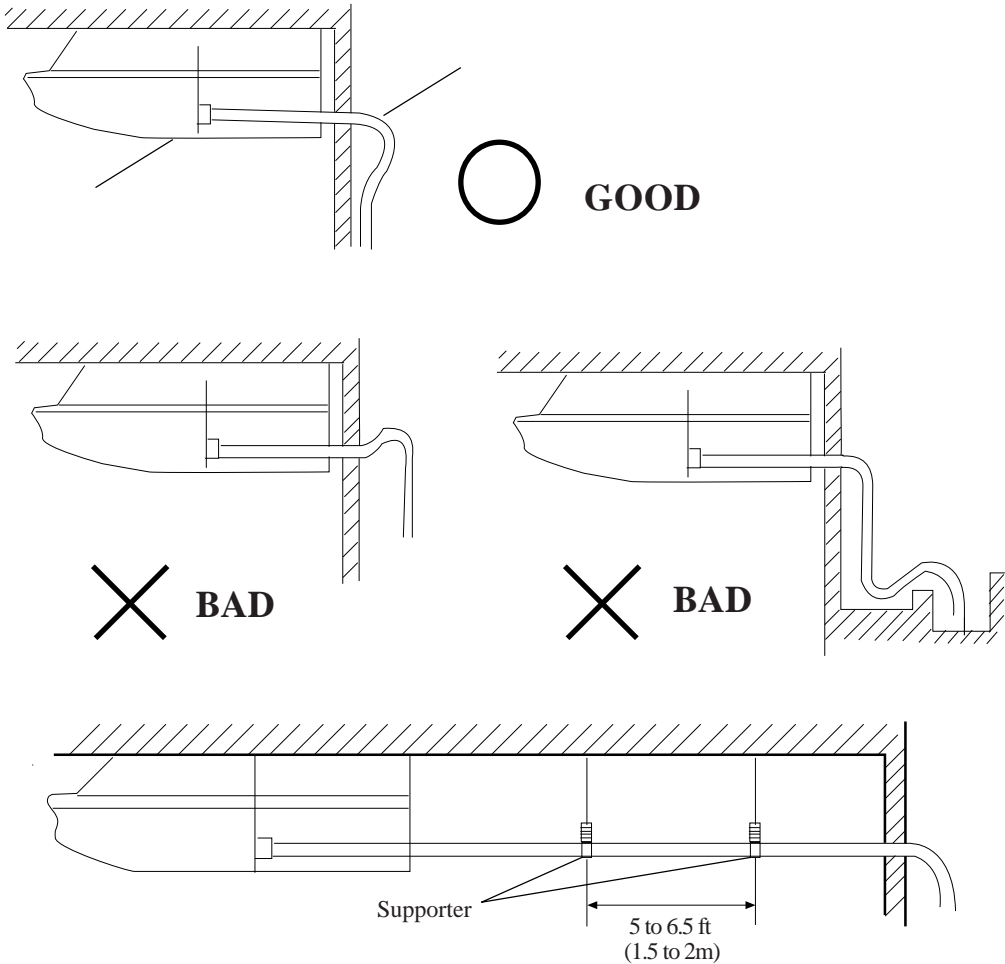

■ Installation of Indoor Unit

(1) Install insulation for the drain pipe.(See Fig.12 and 13)

Cut the included insulation material to an appropriate size and adhere it to the pipe.

Fig. 12

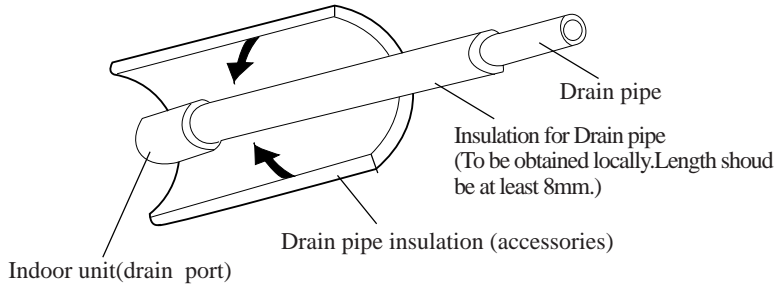
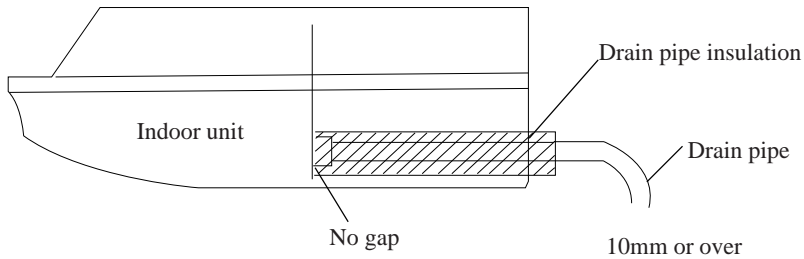

Fig. 13



(2) If "Right rear piping ":fasten the drain pipe with VT wires so that the pipe slopes correctly within the indoor unit.

■ Installation of Indoor Unit

ELECTRICAL WIRING

HOW TO CONNECT WIRING TO THE TERMINALS

A. For solid core wiring (or F-cable)

- (1) Cut the wire and with a wire cutter or wire-cutting pliers, then strip the insulation to about 15/16" (25mm) of expose the solid wire.
- (2) Using a screwdriver, remove the terminal screw(s) on the terminal board.
- (3) Using pliers, bend the solid wire to form a loop suitable for the terminal screw.

B. For strand wiring

- (1) Cut the wire and with a wire cutter or wire-cutting pliers, then strip the insulation to about 3/8" (10mm) of expose the solid wire.
- (2) Using a screwdriver, remove the terminal screw(s) on the terminal board.

Fig. 14

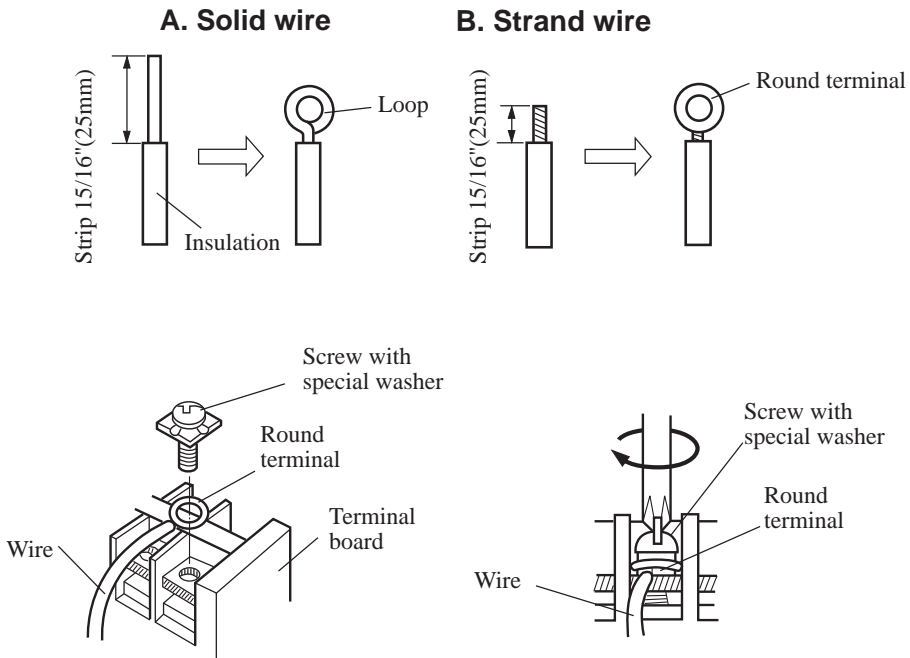

HOW TO FIXED CONNECTION CORD AND POWER CABLE AT THE CORD CLAMP

After passing the connection cord and power cable through the insulation tube, fasten it with the cord clamp, as shown in Fig.15

■ Installation of Indoor Unit

ELECTRICAL REQUIREMENT

• Electric wire size and fuse capacity:

Select wire sizes and circuit protection from table below. (This table shows 20 m length wires with less than 2% voltage drop.)

Table 5

| Item Model | Phase | Circuit breaker | | Power source wire size (minimum) (mm ²) | Earth leakage breaker | |
|-----------------------------|-------|-----------------------|---|--|-----------------------|---------------------|
| | | Switch breaker (A) | Overcurrent protector rated capacity (A) | | Switch breaker(A) | Leak current(mA) |
| For series 282, 362 | 1 | 40 | 26 | 6.0 | 40 | 30 |
| For series 282(EAA) 362 | 3 | 30 | 20 | 2.5 | 30 | 30 |
| For series 522, 482, 602 | 3 | 30 | 20 | 4.0 | 30 | 20 |

Fig. 15

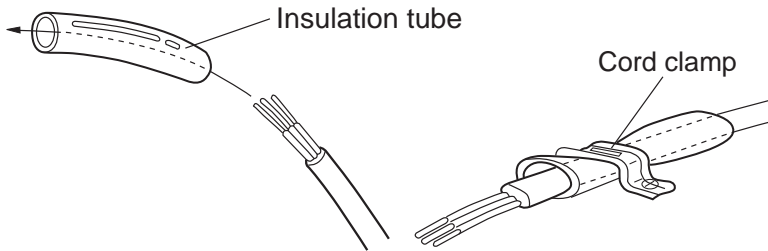

Use VW-1, 0.5 to 1.0 mm thick, PVC tube as the insulation tube.

⚠ CAUTION

- (1) Match the terminal block numbers and connection cord colors with those of the outdoor unit.
Erroneous wiring may cause burning of the electric parts.
- (2) Connect the connection cords firmly to the terminal block. Imperfect installation may cause a fire.
- (3) Always fasten the outside covering of the connection cord with the cord clamp.
(If the insulator is chafed, electric leakage may occur.)
- (4) Always connect the ground wire.

■ Installation of Indoor Unit

FRESH-AIR INTAKE

- (1) Open up the knockout hole for the fresh-air intake, as shown in Fig.16 (If using half-concealed installation, open up the top knockout hole instead)

Fig. 16

For half-concealed

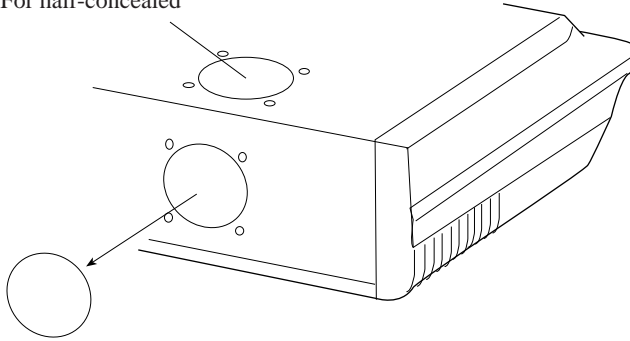

⚠ CAUTION

(1) When removing the cabinet (iron plate), be careful not to damage the indoor unit internal parts and surrounding area (outer case).

(2) When processing the cabinet (iron plate), be careful not to injure yourself with burrs, etc.

- (2) Fasten the round flange (optional) to the fresh air intake, as shown in Fig.17 (If using half-concealed installation, attach to the top.)

Fig. 17

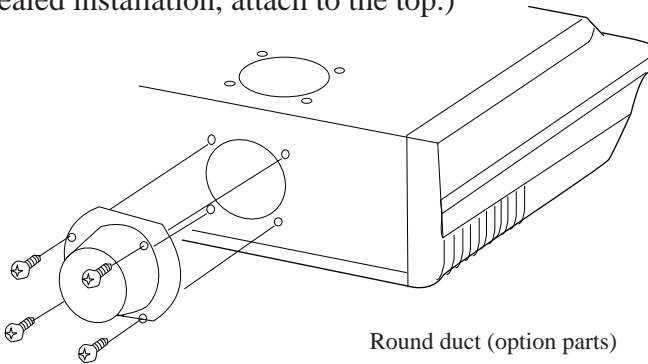

[After completing " INDOOR UNIT INSTALLATION"]

- (3) Connect the duct to the round flange.
(4) Seal with a band and vinyl tape, etc. so that air does not leak from the connection.

Fig. 18

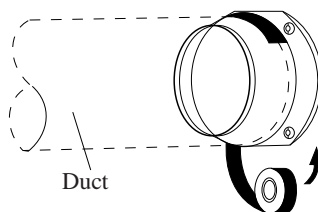

■ Installation of Indoor Unit

- (1) Remove the cord clamp.
- (2) Process the end of the connection cords to the dimensions shown in Fig.19.
- (3) Connect the end of the connection cord fully into the terminal block.
- (4) Fasten the connection cord with a cord clamp.
- (5) Fasten the end of the connection cord with the screw.
- (6) The power cable and connecting cable are self-provided.

Fig. 19 For three phase (380-400V, 3N~, 50Hz), outdoor unit.

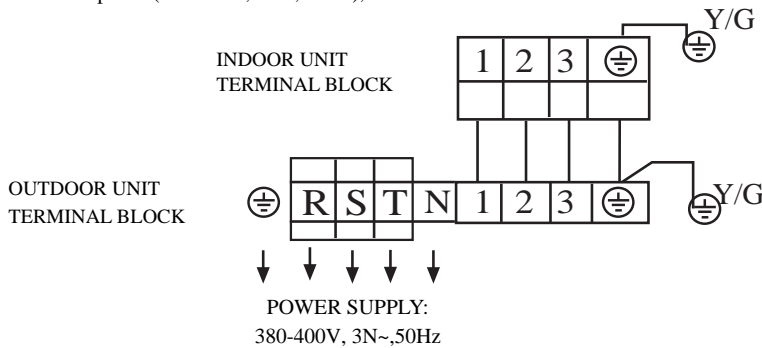

For single phase (1PH, 220-230V~, 50Hz), outdoor unit.

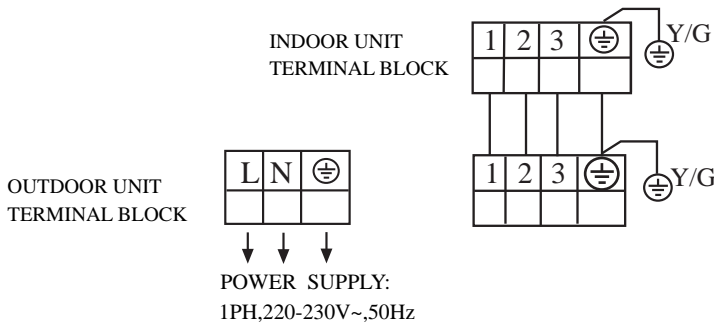

⚠ WARNING

- (1) Always use a special branch circuit and install a special receptacle to supply power to the room air conditioner.
- (2) Use a circuit breaker and receptacle matched to the capacity of the room air conditioner.
- (3) The circuit breaker is installed in the permanent wiring. Always use a circuit that can trip all the poles of the wiring and has an isolation distance of at least 3mm between the contacts of each pole.
- (4) Perform wiring work in accordance with standards so that the room air conditioner can be operated safely and positively.
- (5) Install a leakage circuit breaker in accordance with the related laws and regulations and electric company standards.

■ Installation of Indoor Unit

CAUTION

- (1) The power source capacity must be the sum of the room air conditioner current and the current of other electrical appliances. When the current contracted capacity is insufficient, change the contracted capacity.
- (2) When the voltage is low and the air conditioner is difficult to start, contact the power company the voltage raised.

TEST RUNNING

1. CHECK ITEMS

(1) INDOOR UNIT

- (1) Is operation of each button on the remote control unit normal?
- (2) Does each lamp light normally?
- (3) Do not air flow direction louvers operate normally?
- (4) Is the drain normal?

(2) OUTDOOR UNIT

- (1) Is there any abnormal noise and vibration during operation?
- (2) Will noise, wind, or drain water from the unit disturb the neighbors?
- (3) Is there any gas leakage?





CUSTOMER GUIDANCE

Explain the following to the customer in accordance with the operating manual:

- (1) Starting and stopping method, operation switching, temperature adjustment, timer, air flow switching, and other remote control unit operations.
- (2) Air filter removal and cleaning, and how to use air louvers.
- (3) Give the operating and installation manuals to the customer.



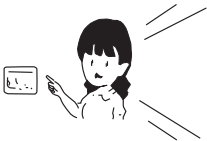





■ Trouble Shooting

Followings are not problems

| | |
|--|---|
| <p>Sound of water flowing is not a problem.</p>  | <p>During unit operation or at stop, a swishing or gurgling noise may be heard. This noise is generated by refrigerant flowing in the system.</p> |
| <p>Sound of cracking is heard.</p> | <p>During unit operation, a cracking noise may be heard. This noise is generated by the casing expanding or shrinking because of temperature changes.</p> |
| <p>Smell are generated.</p> | <p>This is because the system circulates smells from the interior air such as the smell of cigarettes or the painting on the furniture.</p> |
| <p>During operation, white fog or steam comes out from the indoor unit.</p> | <p>When unit is running at places like restaurant, etc. where dense edible oil fumes always exist, this will happen.</p> |
| <p>In cooling operation, unit switches to blowing operation.</p> | <p>To prevent frost from accumulating on indoor heat exchanger, unit will switch to blowing operation for a while then resume cooling operation.</p> |
| <p>Unit will not restart after stop.</p> <p>Won't start?</p>  | <p>Though ON/OFF button is set to ON, unit won't resume cooling, dry or heating operation in 3 min after it is stopped, this is because of 3-min-delay protection circuit.</p>  <p>Please wait 3 minutes</p> |
| <p>No outlet air or fan speed can't be changed in dry mode.</p> | <p>Unit will reduce fan speed repeatedly and automatically if room temp. is too low in dry operation.</p> |
| <p>In heating operation, water or steam are blown out of outdoor unit.</p>  | <p>This occurs when frost accumulated on the outdoor unit is removed. (during defrosting operation)</p>  |
| <p>In heating operation, indoor fan won't stop even if unit is stopped.</p> | <p>After unit stop, indoor fan will go on running until indoor unit cools down.</p> |

Trouble Shooting

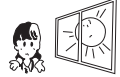
Before ask for services, please first check your unit against the following.

| Air conditioner won't start. | | |
|---|---|---|
| <p>Is power supply switch turned on?</p>  <p>Power supply switch is not set at ON.</p> | <p>Is city power supply normal?</p>  <p>Power failure?</p> | <p>Is leakage current breaker activated?</p> <p>This is very dangerous, please disconnect power supply immediately and contact your dealer.</p> |
| Poor cooling or heating | | |
| <p>Are operation control adjusted correctly as specified?</p>  <p>Proper temp</p> | <p>Is air filter too dirty?</p>  | <p>Are there any obstacles in inlet or outlet grill?</p>  |
| <p>Are horizontal louvers at up position (in heating mode)?</p> | <p>Any doors or windows left open?</p>  | |
| Poor cooling | | |
| <p>Is there any direct sunlight in the room?</p>  | <p>If there are unexpected heat sources in the room?</p>  | <p>Too many people in the room?</p>  |
| <p>Cold air blows out (in heating mode)</p> | | |
| <p>Is air conditioner in standby condition in heating mode?</p> | | |

If your unit still can't work properly after above mentioned checks, or following problems occur, please stop it immediately and contact your dealer.

- Fuses or circuit breakers often blow out.
- Water comes out in cooling/dry operation.
- Operation is abnormal or sound is heard.

Trouble Shooting

Error display (For ERA series)

| For remote type, flash on wired controller times | Failure code on wired controller | For central control, failure code | Failure description | Reason | Remarks |
|--|----------------------------------|-----------------------------------|---|---|--------------------------------------|
| 1 | 01(01H) | 01D | Indoor ambient temp. sensor failure | Sensor broken down or short circuit for more than 2m continuously | ○ |
| 2 | 02(02H) | 02D | Indoor coil temp. sensor failure | Sensor broken down or short circuit for more than 2m continuously | ○ |
| 3 | 74(4AH) | 11D | Outdoor ambient temp. sensor failure | Sensor broken down or short circuit for more than 2m continuously | ○ |
| 4 | 73(49H) | 12D | Outdoor coil temp. sensor failure (compressor discharging temp. sensor) | Sensor broken down or short circuit for more than 2m continuously | ○ |
| 5 | 72(48H) | 10D | Over-current protection | CT check abnormal 3 times in 30m | ✕ |
| 6 | 83(53H) | 14D | High pressure abnormal | High pressure switch acts 3 times in 30m | ✕ |
| 7 | 71(47H) | 2D | Power supply abnormal | Fault phase, short of phase, out of balance greatly | ✕ |
| 8 | 07(07H) | 06D | Communication between wired controller and indoor abnormal | Communication abnormal for more than 4m continuously | ○ |
| 9 | 06(06H) | 06D | Communication between indoor and outdoor abnormal | Communication abnormal for more than 4m continuously | ○ |
| 10 | 08(08H) | 21D | Drainage system abnormal | Float switch broken down for more than 25m continuously | ○ |
| 11 | 11(0BH) | 30D | Outside alarm signal input | Outside signal broken down for more than 10s | ○ |
| 12 | 03(03H) | 20D | Gas pipe temp. sensor abnormal | Sensor broken down or short circuit for more than 2m continuously | ○ |
| 13 | 13(0DH) | 31D | Temperature protection malfunction | Solenoid valve act incorrectly 3 times continuously | ✕ |
| 14 | 76(4CH) | 15D | Discharging temp. sensor abnormal | Sensor broken down or short circuit for more than 2m continuously | ○ |
| 15 | 05(05H) | 17D | EEPROM abnormal | EEPROM data missing | ○ |
| 16 | 84(54H) | 26D | Pressure abnormal(low pressure) | Low pressure switch acts in normal running | ✕ |
| 17 | 80(50H) | 15D | Compressor overheat | The discharging temperature is higher than 120degree | ○ Resumable if lower than 100 degree |
| 18 | 12(0CH) | 23D | Abnormal mode | Indoor operation mode is different with the running indoor unit. | ○ |
| 19 | 75(4BH) | 18D | Outdoor coil B(stuction temp sensor-for MRV II) | Sensor broken down or short circuit for more than 2m continuously | ○ |
| 20 | 77(4DH) | 15D | Outdoor discharging B(oil temp sensor-for MRV II) | Sensor broken down or short circuit for more than 2m continuously | ○ |
| 21 | 20(32D) | 07D | SPDU module temperature protection | Spdu module temperature is too high | ○ |

- shows resumable fault, * shows it is not resumable fault.

Trouble Shooting

Error display (For EAA series)

| For remote type, flash times | Failure code on wired controller | For central control, failure code | Failure description | Reason | Remarks |
|------------------------------|----------------------------------|-----------------------------------|--|---|--------------------------------------|
| 1 | 01(01H) | 01D | Indoor ambient temp. sensor failure | Sensor broken down or short circuit for more than 2m continuously | ○ |
| 2 | 02(02H) | 02D | Indoor coil temp. sensor failure | Sensor broken down or short circuit for more than 2m continuously | ○ |
| 3 | 74(4AH) | 11D | Outdoor ambient temp. sensor failure | Sensor broken down or short circuit for more than 2m continuously | ○ |
| 4 | 73(49H) | 12D | Outdoor coil temp. sensor failure/Compressor discharging temp. sensor abnormal | Sensor broken down or short circuit for more than 2m continuously | ○ |
| 5 | 72(48H) | 10D | Over-current protection | CT check abnormal 3 times in 30m | ✕ |
| 6 | 83(53H) | 14D | High/Low pressure abnormal | High pressure switch acts 3 times in 30m/Low pressure switch acts in normal running | ✕ |
| 7 | 71(47H) | 22D | Power supply abnormal | Fault phase, short of phase, out of balance greatly | ✕ |
| 8 | 07(07H) | 06D | Communication between wired controller and indoor abnormal | Communication abnormal for more than 4m continuously | ○ |
| 9 | 06(06H) | 06D | Communication between indoor and outdoor abnormal | Communication abnormal for more than 4m continuously | ○ |
| 10 | 08(08H) | 21D | Drainage system abnormal | Float switch broken down for more than 25m continuously | ○ |
| 11 | 11(0BH) | 30D | Outside alarm signal input | Outside signal broken down for more than 10s | ○ |
| 12 | 03(03H) | 20D | Gas pipe temp. sensor abnormal | Sensor broken down or short circuit for more than 2m continuously | ○ |
| 13 | 13(0DH) | 31D | Temperature protection malfunction | Solenoid valve act incorrectly 3 times continuously | ✕ |
| 15 | 05(05H) | 17D | EEPROM abnormal | EEPROM data missing | ○ |
| 17 | 80(50H) | 15D | Compressor overheat | The discharging temperature is higher than 120degree | ○ Resumable if lower than 100 degree |
| 18 | 12(0CH) | 23D | Abnormal mode | Indoor operation mode is different with the running indoor unit. | ○ |
| 19 | 75(4BH) | 18D | Outdoor coil B(suction temp sensor-for MRV II) | Sensor broken down or short circuit for more than 2m continuously | ○ |
| 20 | 77(4DH) | 15D | Outdoor discharging B(oil temp sensor-for MRV II) | Sensor broken down or short circuit for more than 2m continuously | ○ |

● shows resumable fault, * shows it is not resumable fault.

HAIER GROUP

Qingdao Haier Air Conditioner Electric Co., Ltd.

Address: Haier Garden ,Qianwangang Road , Economic Development Zone,
Qingdao ,Shandong 266500, P.R.China

Web Site: <http://www.haier.com>