

Honeywell

Heating, Air Conditioning or Heating/Air Conditioning Thermostats

INSTALLATION INSTRUCTIONS

The CT50A is for most gas and oil heating-only systems.

The CT50C is for most electric air conditioning-only systems.

The CT51A is for most gas, oil, or electric heating/electric air conditioning systems.

The CT53A is for millivoltage heating systems.

Do-it-yourself models
CT50A,C; CT51A; CT53A

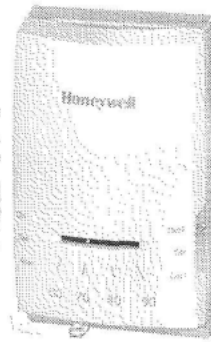

CT51A shown

YOUR NEW THERMOSTAT

Your new Honeywell CT50A Heating Thermostat will replace most 15 to 30 V, 2-wire heating system thermostats. The CT50A is suitable only for gas or oil heating systems (NOT for air conditioning, heating/air conditioning, heat pump or electric heating systems).

Your new CT50C Cooling Thermostat will replace most 15

to 30 V, 3-wire air conditioning system thermostats (NOT for heating, heating/air conditioning or heat pump systems).

Your new CT51A Heating/Cooling Thermostat will replace most 15 to 30 V, 4-wire, heating/cooling system thermostats. The CT51A is suitable for gas, oil or electric heating/electric air conditioning systems (NOT for heat pumps).

Your new CT53A Heating Thermostat is suitable for 250, 500 or 750 millivolt (mV) heating systems only.

CON

PREPA

THERM

REMOV

WIRE A

CHECK

THERM

TROUB

RECALI

1

PREPARATION

Proper installation of your new thermostat will occur if you follow instructions STEP-BY-STEP. It is recommended that as you read, understand and complete each step, you check it off with pencil or pen.

If you are unsure about wiring procedures, please call a qualified service technician for assistance.

Check thermostat suitability for your home's system by reviewing YOUR NEW THERMOSTAT section, above.

Assemble tools required, as shown left.

Make certain that your burner/air conditioner (where applicable) are working, especially if they have been inoperative for any length of time. If either does not work, contact your local heating/air conditioning dealer. Do NOT operate the air conditioning system if outdoor temperature is below 50° F [10° C].

Carefully unpack your new thermostat. Remove and discard the packing insert under the cover.

Save package of screws and instruction pages.



FLAT BLADE SCREWDRIVER

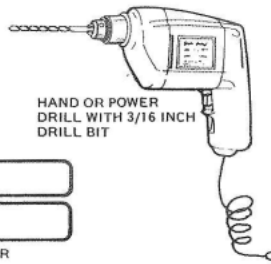

HAND OR POWER DRILL WITH 3/16 INCH DRILL BIT

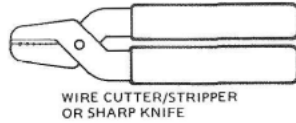

WIRE CUTTER/STRIPPER OR SHARP KNIFE

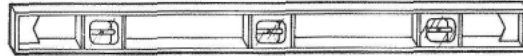

SPIRIT LEVEL OR PLUMB BOB AND LINE

11,953A

anticipator adjustment mechanism. (See last illustration under step 4 to help you recognize the heat anticipator.) Make a note here of that anticipator setting for future reference. The heat anticipator pointer, if adjustable, will be set at one of a series of numbers representing the (electrical) current rating of the primary control of your system in amps. The number will range from 0.18 to 1.0. If no heat anticipator/indication is showing, do not be concerned; move on to the next step.

Loosen screws holding thermostat base to subbase or wall, and lift away.

Disconnect wires from old thermostat or subbase. If your thermostat has more than 2 wires, as you disconnect each wire, tape the end and label it with the letter of the terminal designation to make reconnection to new thermostat easier. Take care that these wires do not fall back into the wall opening.

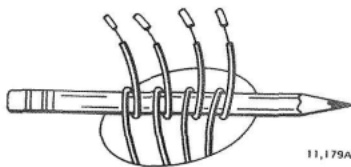

11,179A

Keep the old thermostat for reference purposes until your new thermostat is functioning smoothly.

4

WIRE AND MOUNT THERMOSTAT

For CT50A: Connect each wire from the wall to either terminal on the back of the thermostat. Tighten the screws.

For CT50C or CT51A: Connect wires

from the wall to matching terminals on back of thermostat. Tighten the screws.

NOTE: If terminal designations on old thermostat do not match those on new thermostat, refer to chart below.

OLD THERMOSTAT TERMINAL MARKED	FUNCTION	NEW THERMOSTAT TERMINAL MARKED
G or F	Fan	G
Y or C	Cooling	Y
W or H	Heating	W
RC, V, VC or B	Power	You have a 5-wire system, and cannot use this thermostat; we recommend a CT87B instead.
RH, M, VR, 4, A or R	Power	R

CAUTION

If using CT51A for ELECTRIC furnace systems, you may need to install a jumper between thermostat terminals 1 and 2. If your old subbase is a Q539G, Q539J, Q634D or Q634G, you need the jumper. If in doubt about old subbase number, see section 3. If jumper is needed and is not installed, the furnace could overheat, causing a fire hazard. Use 18 gauge insulated wire; strip ends before installing.

THER FE

CONTENTS

STEP

PREPARATION	1
THERMOSTAT FEATURES	2
REMOVING OLD THERMOSTAT	3
WIRE AND MOUNT NEW THERMOSTAT	4
CHECK OUT THE THERMOSTAT	5
THERMOSTAT SETTING	6
TROUBLESHOOTING	7
RECALIBRATE THERMOMETER	8

LIMITED ONE-YEAR WARRANTY

Honeywell warrants this product to be free from defects in workmanship or materials, under normal use and service, for a period of one (1) year from the date of purchase by the consumer. If, at any time during the warranty period, the product is defective or malfunctions, Honeywell shall repair or replace it (at Honeywell's option) within a reasonable period of time.

If the product is defective:

- return it, with a bill of sale, receipt, or other dated proof of purchase, to the dealer or contractor from which you purchased it, or
- package it carefully, along with a bill of sale, receipt, or other dated proof of purchase, and a short description of the malfunction, and mail it, postage prepaid, to the following address:

Honeywell Inc. Returned Goods Department 1050 Berkeley Lane Plymouth, MN 55441-4401	In Canada: Honeywell Limited/Honeywell Limitee 740 Ellesmere Road Scarborough, Ontario M1P2V9
--	--

This warranty does not cover removal or reinstallation costs. This warranty shall not apply if it is shown by Honeywell that the defect or malfunction was caused by damage which occurred while the product was in the possession of a consumer.

Honeywell's sole responsibility shall be to repair or replace the product within the terms listed above. HONEYWELL SHALL NOT BE LIABLE FOR ANY LOSS OR DAMAGE OF ANY KIND, INCLUDING ANY INCIDENTAL OR CONSEQUENTIAL DAMAGES RESULTING, DIRECTLY OR INDIRECTLY, FROM ANY BREACH OF ANY WARRANTY, EXPRESS OR IMPLIED, OR ANY OTHER FAILURE OF THIS PRODUCT. Some states do not allow the exclusion or limitation of consequential damages, so this limitation may not apply to you.

THIS WARRANTY IS THE ONLY EXPRESS WARRANTY HONEYWELL MAKES ON THIS PRODUCT. THE DURATION OF ANY IMPLIED WARRANTIES, INCLUDING THE WARRANTIES OF MERCHANTABILITY AND FITNESS FOR A PARTICULAR PURPOSE, IS HEREBY LIMITED TO THE ONE YEAR DURATION OF THIS WARRANTY. Some states do not allow limitations on how long an implied warranty lasts, so the above limitation may not apply to you.

This warranty gives you specific legal rights, and you may have other rights which vary from state to state. If you have any questions concerning this warranty, please write our Consumer Affairs department, Honeywell Inc., 1885 Douglas Drive North, Golden Valley, MN 55422-4386. In Canada—Honeywell Limited/Honeywell Limitee, 740 Ellesmere Road, Scarborough, Ontario M1P2V9, or call toll-free at 1-800-468-1992.

R.T.
Rev. 9-97

Printed in U.S.A.

Form Number 69-0514-2
©Honeywell Inc. 1997

2

THERMOSTAT FEATURES

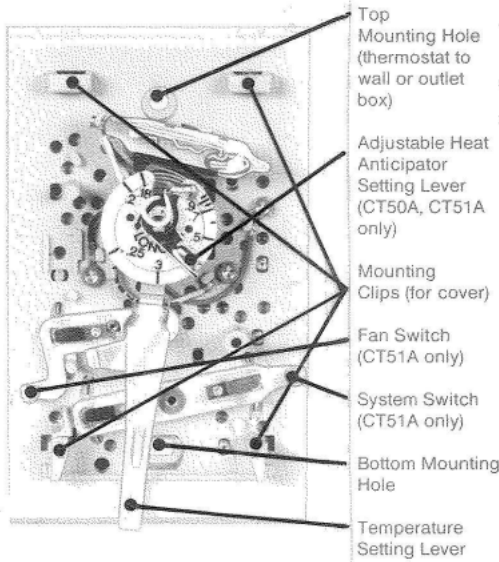

3

REMOVING OLD THERMOSTAT

If you have an electric furnace, you need to determine how your fan is controlled. Turn it on and adjust your present thermostat so the heat comes on, while observing

when the fan comes on. If the fan comes on immediately you need to add the jumper noted in section 4 between terminals 1 & 2. If there is a noticeable delay before the fan comes on, there is no need to add the jumper because your furnace controls the fan.

Begin by turning off power to the heating/air conditioning system at the main fuse panel. Most residential systems have a separate switch box or circuit breaker for disconnecting power to the furnace.

Remove cover of old thermostat—cover normally snaps off when pulled firmly from the bottom. If it resists, check for a screw that locks the cover on.

For CT50A or CT51A installation, before removing the old thermostat from the wall, look at it carefully to locate the heat

ostat.
not match

OSTAT
MARKED

5-wire
cannot
rmostat;
end a
lead.

R

you may
inals 1
634D or
old sub-
d and is
g a fire
s before

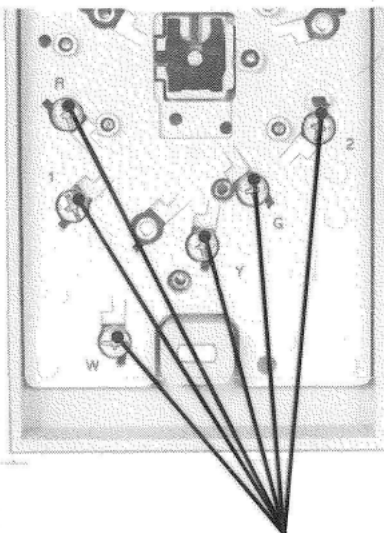

Terminal Screws
(CT51A shown)

For CT53A:
Connect wires to R and W for 750 mV systems. Connect to R and Y for 250 or 500 mV systems. Tighten the screws.

Push excess wire back into wall and plug hole with nonflammable insulation to prevent drafts from affecting thermostat operation.

Grasp the thermostat cover at the top and bottom with one hand. Pull outward on the bottom edge of the thermostat cover until it snaps free of the thermostat base.

Fasten thermostat to wall or vertical outlet box with a screw through the top mounting hole. See step 2 for hole location.

Place a bubble level or plumb line against the thermostat to find the level position. Start a screw in the center of the bottom mounting hole. Move the temperature setting lever if necessary to uncover the mounting hole.

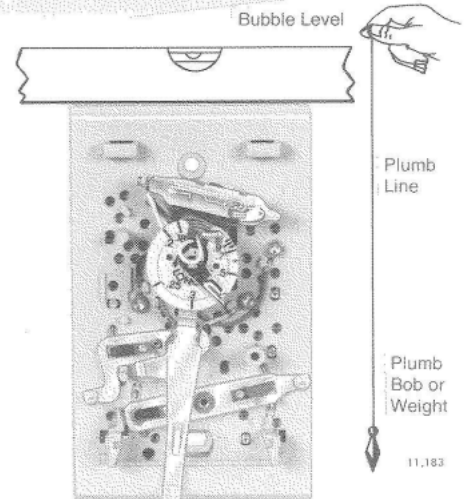

4 WIRE AND MOUNT THERMOSTAT (continued)

- Recheck for level positioning, and firmly tighten both mounting screws.
- If installing CT50A or CT51A, make sure you have the current (anticipator setting) for your system. This is the number you wrote in the box in step 3. If you were unable to find the current draw for step 3, this information can be found printed on the primary control at the furnace. The primary control is usually a gas valve, zone valve, or a relay or burner control box with the thermostat wires connected to it. For electric heat, you need to add the fan relay current, usually 0.2 to 0.4 A.

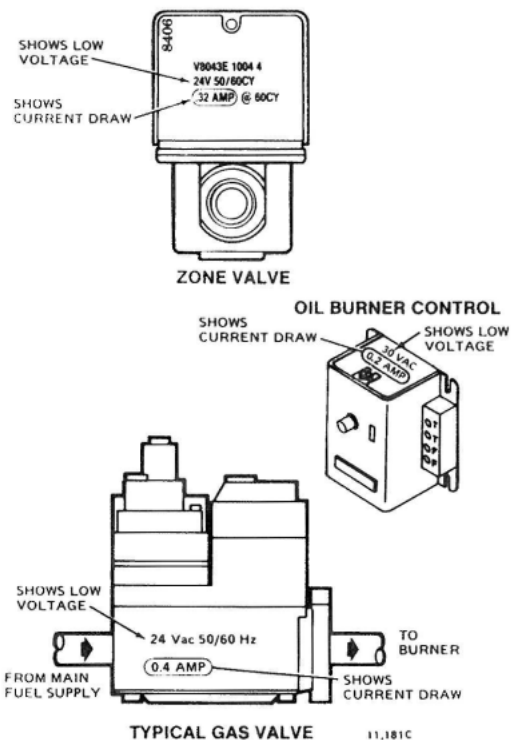

- On the CT50A or CT51A, set heat anticipator indicator at rating printed on primary control.

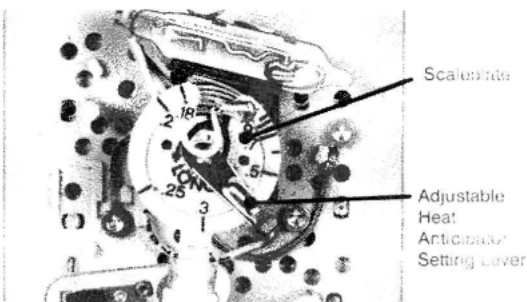

- Press the thermostat cover firmly onto the mounting clips.

CAUTION

1. If your anticipator is set too low, it may burn out.
2. Shorting out your valve or control could cause your anticipator to burn out.

5

CHECK OUT THE THERMOSTAT

CAUTION

To prevent possible compressor damage, do not operate air conditioning if outdoor temperature is below 50° F [10° C]. Once the air conditioner is off, do not turn it on for 5 minutes; this action will prevent compressor damage.

- On the CT51A, the system switch controls as follows:
 - HEAT—heating system only operates.
 - OFF—heating and air conditioning systems are disconnected.
 - COOL—air conditioning system only operates.The fan switch controls as follows:
 - AUTO—fan operates when heating or air conditioning system operates.

ON—fan operates continuously.

NOTE: In the following instruction, disregard heating or air conditioning directions if not applicable to your system.

- Turn on power to the heating/air conditioning system.
- Observe system operation for at least one cycle on both heating and air conditioning. To observe:
 - Place the system switch at HEAT position and fan switch at AUTO. Move the temperature setting lever 10° F [6° C] above room temperature. The heating equipment should turn on. A short warm-up period may be required before the system fan turns on.
 - Place system switch at COOL position and move temperature setting lever 10° F [6° C] below room temperature. The air conditioning equipment should turn on and the system fan should turn on.

NOTE: Some systems have a time delay that can prevent operation up to 5 minutes.

- Turn the fan switch to ON. The system fan should turn on, and operate continuously. The system blower should continue to operate at any system switch or thermostat setting.

6

THERMOSTAT SETTING

- On CT51A, place the system and fan switches at the desired settings for operation.
- On all models, move the temperature setting lever to the desired temperature comfort level.

7

TROUBLESHOOTING

Your Honeywell thermostat requires little or no attention. Most problems can generally be traced to the following:

NOTE: If your system is heating-only or air conditioning-only, disregard sections not applicable to your system.

SYMPTOM	PROBLEM	CORRECTIVE ACTION	SYMPTOM	PROBLEM	CORRECTIVE ACTION
No heat	System switch at OFF or COOL Position.	Move switch to HEAT position.	Thermostat setting and thermometer reading disagree.	Thermostat is not level.	Recheck the thermostat position on wall. Use a bubble level to make sure it's level. See step 4.
	Blown fuse or tripped circuit breaker.	Replace fuse or reset circuit breaker.		Thermostat affected by drafts or radiant heat.	Contact a qualified service technician to change the location. The thermostat should be about 5 ft [1.5 m] above the floor and on an inside wall.
	Furnace power switch is on OFF.	Switch to ON.		Thermostat is out of calibration.	Contact a qualified service technician to recalibrate the thermostat.
	No pilot flame.	Relight pilot flame per furnace manufacturer's instructions.		Thermometer is out of calibration.	Recalibrate. See step 8.
	Improper connections to thermostat.	With power to furnace OFF, tighten all mounting and terminal screws. Repair frayed or broken wires.		No air conditioning.	System switch in in OFF or HEAT position.
Furnace turns on and off.	Defective thermostat. (Here's how you tell: Remove the thermostat from the wall. Disconnect wire from W terminal. Touch W wire to R terminal. The thermostat is defective if the burner comes on.)	Exchange the thermostat (see Warranty).	Blown fuse or tripped circuit breaker.	Replace fuse or reset circuit breaker.	Replace fuse or reset circuit breaker.
	Other.	Contact a qualified service technician for assistance.	Compressor switch (located outdoors) is turned OFF.	Move switch to ON position.	Move switch to ON position.
Major swings in temperature (greater than 2° F [1° C] when outside temperature is stable).	Burner ON period is too short.	Remove the thermostat cover and move the heat anticipator lever COUNTERCLOCKWISE ↺ one scale mark. Replace the cover and wait several hours for the system to stabilize.	Improper connections to thermostat.	With power to furnace OFF, tighten all mounting and terminal screws. Repair broken wires.	With power to furnace OFF, tighten all mounting and terminal screws. Repair broken wires.
	Burner ON period is too long.	Remove the thermostat cover and move the heat anticipator lever CLOCKWISE ↻ one scale mark. Replace the cover and wait several hours for the system to stabilize.	Defective thermostat. (Here's how you tell: Remove the thermostat from wall. Disconnect wire from Y terminal. Touch Y wire to terminal R. The thermostat is defective if the compressor starts. Some systems have a time delay, so allow at least 5 minutes.) See caution in section 5.	Exchange the thermostat. See Warranty.	Exchange the thermostat. See Warranty.
			Other.	Contact service technician for assistance.	Contact service technician for assistance.

8

RECALIBRATE THERMOMETER

If the thermostat set point and the thermometer reading do not agree, the thermometer may need recalibration. Follow the procedure below.

- Remove thermostat cover.
- Set the cover on a table near an accurate thermometer.
- After allowing 5 or 10 minutes for stabilization, compare the readings.

If the readings are the same, replace cover and put the system into operation.

If the readings are different, insert a hex-head wrench in the thermometer shaft and turn it until the thermometers have the same reading.

Replace cover and put the system into operation.

