



## ***ARRAY APPLICATIONS MANUAL***

***FOR MODELS VT4889, VT4888, VT4887, VT4881, VT4880***



# TABLE OF CONTENTS

	PAGE
GENERAL AMPLIFICATION NOTES & REQUIREMENTS.....	3
SUBWOOFER WIRING NOTES.....	4
STANDARD AMPLIFICATION RACK	
LIMITER SETTINGS NOTES .....	5
VT4887 & VT4881 TRANSDUCER COMPLEMENT.....	5
AMPLIFIER CONFIGURATION OPTIONS	
VT4887 & VT4881 ARRAY WIRING.....	7
VT4888 TRANSDUCER COMPLEMENT.....	8
AMPLIFIER CONFIGURATION OPTIONS	
VT4888 ARRAY WIRING.....	10
VT4889 TRANSDUCER COMPLEMENT.....	11
AMPLIFIER CONFIGURATION OPTIONS	
VT4880 TRANSDUCER COMPLEMENT & AMPLIFIER CONFIGURATION..	12
VT4889 ARRAY WIRING .....	13
VERTEC SYSTEMS SUSPENSION HARDWARE AND ASSEMBLY NOTES.....	14
PARTS GUIDE: VERTEC SYSTEMS SUSPENSION HARDWARE.....	15
VERTEC VT4888, VT4887, VT4881: SYSTEM SUSPENSION FRAMES.....	16
VERTEC: SYSTEM SUSPENSION HINGE BARS.....	17
PICTURE: VT4889 WITH VT4887 HANG UNDER USING VT4800-DA.....	18
PICTURE: VT4887 CLUSTER SUSPENDED USING VT4887-AF.....	19
VERTEC SUPPORT TEAM AND WEBLINKS.....	20

## **GENERAL AMPLIFICATION NOTES & REQUIREMENTS**

- For the purpose of this discussion: Crown MA series amplifiers are used below. HF indicates High Frequency drivers, MF indicates Mid Frequency drivers, LF indicates Low Frequency drivers and VLF stands for Very Low Frequency drivers (subwoofers).
- Equivalent amplifiers can be used as substitutions.
- Users should observe differences in input sensitivity and maximum available power at a given impedance load.
- Users may choose to use the same size amplifier to power all components / passbands.
- DSP crossover presets provided by JBL assume that the same amplifier models with equal voltage gain, are used for each bandpass.
- If different gain settings or amplifiers models are used, users may need to adjust the output gains of the digital controller(s).

### **VT4889**

- 4 VT4889 can be powered with (4) MA-3600, although the MA-5002 is recommended.
  - Two boxes are wired in parallel per NL8 circuit.
  - (HF: CH1 & CH2, MF: CH1 & CH2, LO1: CH1 & CH2, LO2: CH1 & CH2)
- Using MA-5002's would provide enough power to drive up to 6 VT4889.
  - Three boxes are wired in parallel per NL8 circuit.
- MA-2402 or MA-3600 can be used for the HF section to power 2 or 3 boxes.

### **VT4888**

- 4 VT4888 can be powered with (4) MA-3600, although the MA-5002 is recommended.
  - Two boxes are wired in parallel per NL8 circuit.
  - (HF: CH1 & CH2, MF: CH1 & CH2, LO1: CH1 & CH2, LO2: CH1 & CH2)
- Using MA-5002's would provide enough power to drive up to 6 VT4888.
  - Three boxes are wired in parallel.
- MA-2402 or MA-3600 can be used for the HF section to power 2 or 3 boxes.

### **VT 4887**

- 4 VT4887 can be powered with one (1) MA-5002.
  - If four boxes are wired in parallel per NL8 circuit then  
CH1: LF @ 2 ohms & CH2: MH/HF @ 2 ohms.
- MA-2402 or MA-3600 or MA-36x12 can be used if 2 boxes are wired in parallel instead.

### **VT4880**

- 2 VT4880 are usually wired to (1) MA-3600 or (1) MA-5002.
  - If two boxes are wired in parallel using NL4 cables then  
CH1: 2258 left, pin 1± @ 4 ohms & CH2: 2258 right, pin 2± @ 4 ohms.
- Up to 3 boxes could be wired in parallel with loads of 2.7 ohms per amp channel.

### **VT4881**

- 2 VT4881 are usually wired to (1) MA-3600 or (1) MA-5002.
  - If two boxes are wired in parallel using NL8 cables then  
CH1: 2256G coil 1, pin 1± @ 4 ohms & CH2: 2256G coil 2, pin 2± @ 4 ohms.
- Up to 3 boxes could be wired in parallel with loads of 2.7 ohms per amp channel.
- Make parallel connections at amplifier rack to minimize cable losses.

## **NOTES ON SUBWOOFER WIRING**

- VT4880: Users may choose to wire both 2258 (18") components in parallel to one (1) channel of a MA-3600 or MA-5002 for (4) ohms load. In this case each amplifier channel drives one VT4880. If two VT4880 are wired in parallel, the load is two ohms and there will be no amplifier power headroom.
- VT4881: Users may choose to wire both coils in a single 2256G component in parallel to one (1) channel of a MA-3600 or MA-5002 for (4) ohms load. In this case each amplifier channel drives one VT4881. If two VT4881 are wired in parallel, the load is two ohms.

**USERS MUST NOT WIRE THE VOICE COILS ON A 2256G (VT4881) OUT OF POLARITY TO EACH OTHER.**

**NL8: PIN 1<sub>+</sub> = RED CONNECTOR A & BLACK CONNECTOR A**

**NL8: PIN 2<sub>+</sub> = RED CONNECTOR B & BLACK CONNECTOR B**

## **STANDARD AMPLIFICATION RACK**

For those users looking to minimize amplifier rack configurations, one rack with 4 MA-5002 and 2 NL8 output circuits can power up to:

- 4 to 6 VT4889 (2 or 3 boxes per circuits AMPS: HF, MF, LF1, LF2)
  - OR
- 4 to 6 VT4888 (2 or 3 boxes per circuits AMPS: HF, MF, LF1, LF2)
  - OR
- 8 VT4887 & 4 VT4881
  - (4 VT4887 & 2 VT4881 per circuit AMPS: MF/HF, LF, VLF1, VLF2)

This rack would use the same input signal path from the digital controller of choice. Users would only need to recall the appropriate DSP file on the unit.

- VT4889 or VT4888
  - DSP outputs: LO, MID, HIGH (stereo)
- VT4887 & VT4881
  - DSP outputs: SUB, LO, MID/HIGH (stereo)

## NOTES REGARDING LIMITER SETTINGS

- The recommended limiter threshold settings provide 3 dB of headroom before the component or bandpass peak voltage is reached.
- The component or bandpass peak voltage is 6 dB above the voltage used at continuous maximum power.
- These settings assume the use of a Crown MA-5002 in stereo mode with input sensitivity of 1.4V for a voltage gain of 37 dB. Amplifier limiter and Offset Integration switches are set to the off position.
- If a different amplifier is used or if the input sensitivity is changed, the limiter threshold must be re-calculated.
- Not all DSP controllers behave the same way. Please study your unit accordingly.
- Users must take into consideration that the digital controller gain outputs are not all “0” dB, i.e. for VT4889/4880, the VLF is at +6 dB, the LF is at 0 dB, the MF is at -2.5 dB and the HF is at -4 dB. Hence, the actual headroom before limiter threshold is effectively greater than it may seem from the above charts.
- Users should carefully test these settings, and lower or raise the thresholds for a given type of program material as required.

## VT4887 & VT4881 TRANSDUCER COMPLEMENT:

	Model	Speakon NL8 Terminals	Per box	Nominal Impedance per Transducer	Nominal Impedance per Passband	AES Power 100 HR Rating per Transducer	Peak Power Rating per Transducer	Recommended Power per Passband
HF	<b>2407H</b>	Pins 4± <sup>1</sup>	x 2	8Ω	8Ω	25W	100W	450W
MF	<b>2104H</b>	Pins 4± <sup>1</sup>	x 4	8Ω	8Ω	50W	200W	450W
LF	<b>2168J</b>	Pins 3± <sup>2</sup>	x 2	16Ω	8Ω	350W	1400W	1000W
VLF	<b>2256G</b>	Pins 1± & 2± <sup>3</sup>	x 1	2 x 8Ω	8Ω + 8Ω	600W	2400W	1200W

<sup>1</sup> PASSIVELY CROSSED OVER MID/HIGH FREQUENCY SECTION.

<sup>2</sup> LF SECTION HAS TWO 8” COMPONENTS WIRED IN PARALLEL.

<sup>3</sup> SINGLE COMPONENT WITH TWO VOICE COILS INDEPENDENTLY WIRED.

## AMPLIFIER CONFIGURATIONS: 4 x VT4887 & 2 VT4881 / 3 MA-5002

Amplifier Channel	Speakon NL8 Terminals	Driving	Nominal Impedance at Pins	Amplifier Power Rating at Nominal Impedance	Power Available to each Bandpass	Bandpass Peak Voltage Vac	Limiter Threshold dBu
Ch 1. MA-5002VZ Ch2.	Pins 4±	4 x 2407H & 8 x 2104H	4Ω	1800W	900W	54V	-3
	Pins 4±	4 x 2407H & 8 x 2104H	4Ω	1800W	900W	54V	-3
Ch 1. MA-5002VZ Ch2.	Pins 3±	4 x 2168J	4Ω	1800W	900W	134V	4
	Pins 3±	4 x 2168J	4Ω	1800W	900W	134V	4
Ch 1. MA-5002VZ Ch2.	Pins 1± & 2±	1 x 2256G	4Ω	1800W	900W	86V	-2*
	Pins 1± & 2±	1 X 2256G	4Ω	1800W	900W	86V	-2*

\* 6 dB of headroom required for extended bandpass.

## AMPLIFIER CONFIGURATIONS: 4 x VT4887 & 2 VT4881 / 3 MA-3600

Amplifier Channel	Speakon NL8 Terminals	Driving	Nominal Impedance at Pins	Amplifier Power Rating at Nominal Impedance	Power Available to each Bandpass	Bandpass Peak Voltage Vac	Limiter Threshold dBu
Ch 1. MA-3600 VZ Ch2.	Pins 4±	4 x 2407H & 8 x 2104H	4Ω	1120W	560W	54V	-3
	Pins 4±	4 x 2407H & 8 x 2104H	4Ω	1120W	560W	54V	-3
Ch 1. MA-3600 VZ Ch2.	Pins 3±	4 x 2168J	4Ω	1565W	783W	134V	4
	Pins 3±	4 x 2168J	4Ω	1565W	783W	134V	4
Ch 1. MA-3600 VZ Ch2.	Pins 1± & 2±	1 x 2256G	4Ω	1565W	1565W	86V	1
	Pins 1± & 2±	1 X 2256G	4Ω	1565W	1565W	86V	1

EASY:        1 X MA-3600 = 2 VT4887  
                   1 X MA-3600 = 2 VT4881

# JBL VERTEC VT4887 WITH VT4881

POWER AMPLIFIER CONFIGURATIONS - 4 + 2 BOX ARRAY

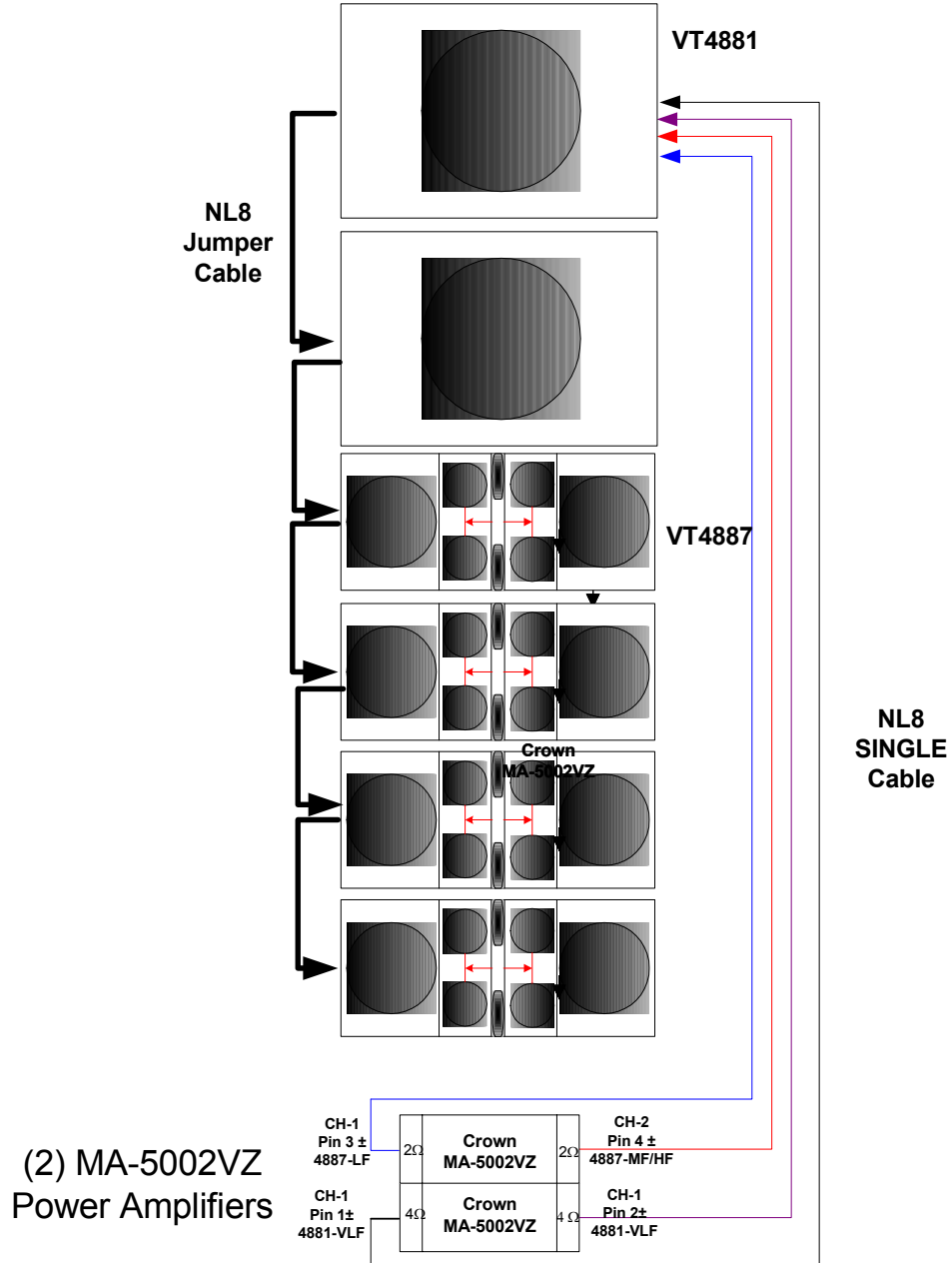

## IMPORTANT NOTES:

All wiring configurations shown above use 8-conductor speaker cables terminated with Neutrik NL8 "Speakons". Ensure that each conductor in the cable is a minimum of #13 AW (3-4 mm).

### JBL VT4887:

The MF & HF section of a VT4887 has an internal passive crossover network.

This network connects **two** 2407H HF drivers (8Ω) wired in series

and **four** 2104H MF (8Ω) wired in Series / Parallel.

The LF section of a VT4887 has **two** 2168J drivers (16Ω) wired in Parallel.

=8Ω

Pins 4±

=8Ω

Pins 3±

### JBL VT4881:

The single 15" 2256G VLF device has **two** 8Ω coils wired independently.

=8Ω/8Ω

Pins 1±, 2±

## VT4888 TRANSDUCER COMPLEMENT:

	Model	Speakon NL8 Terminals	Per box	Nominal Impedance per transducer	Nominal Impedance per Passband	AES Power 100 HR Rating per Transducer	Peak Power Rating per Transducer	Recommended Power per Passband
HF	2431H	Pins 4±	x 2	8Ω	16Ω	75W	300W	300W
MF	2106H	Pins 3±	x 4	8Ω	8Ω	100W	400W	800W
LF	2262H	Pins 1± & 2±	x 2	8Ω	8Ω + 8Ω	700W	2800W	2500W

## AMPLIFIER CONFIGURATIONS: 4 VT4888 / 3 MA-5002VZ

Amplifier Channel	Speakon NL8 Terminals	Driving	Nominal Impedance at Pins	Amplifier Power Rating at Nominal Impedance	Power Available to each Component	Bandpass Peak Voltage Vac	Limiter Threshold dBu
Ch 1. MA-5002VZ Ch2.	Pins 4±	4 x 2431H	8Ω	1300W	325W	56V	-3
	Pins 4±	4 x 2431H	8Ω	1300W	325W	56V	-3
Ch 1. MA-5002VZ Ch2.	Pins 3±	8 x 2106H	4Ω	2000W	250W	112V	3
	Pins 3±	8 x 2106H	4Ω	2000W	250W	112V	3
Ch 1. MA-5002VZ Ch2.	Pins 1± & 2±	4 x 2262H	2Ω	2500W	625W	130V	2
	Pins 1± & 2±	4 x 2262H	2Ω	2500W	625W	130V	2

## AMPLIFIER CONFIGURATIONS: 4 VT4888 / 4 MA-5002VZ

Amplifier Channel	Speakon NL8 Terminals	Driving	Nominal Impedance at Pins	Amplifier Power Rating at Nominal Impedance	Power Available to each Component	Bandpass Peak Voltage Vac	Limiter Threshold dBu
Ch 1. MA-5002VZ Ch2.	Pins 4±	4 x 2431H	8Ω	1300W	325W	56V	-3
	Pins 4±	4 x 2431H	8Ω	1300W	325W	56V	-3
Ch 1. MA-5002VZ Ch2.	Pins 3±	8 x 2106H	4Ω	2000W	250W	112V	3
	Pins 3±	8 x 2106H	4Ω	2000W	250W	112V	3
Ch 1. MA-5002VZ Ch2.	Pins 2±	2 x 2262H	4Ω	2000W	1000W	130V	2
	Pins 2±	2 x 2262H	4Ω	2000W	1000W	130V	2
Ch 1. MA-5002VZ Ch2.	Pins 1±	2 x 2262H	4Ω	2000W	1000W	130V	2
	Pins 1±	2 x 2262H	4Ω	2000W	1000W	130V	2



## AMPLIFIER CONFIGURATIONS: 6 VT4888 / 4 MA-5002VZ

Amplifier Channel	Speakon NL8 Terminals	Driving	Nominal Impedance at Pins	Amplifier Power Rating at Nominal Impedance	Power Available to each Component	Bandpass Peak Voltage Vac	Limiter Threshold dBu
<b>Ch 1. MA-5002VZ Ch2.</b>	Pins 4±	6 x 2431H	5.7Ω	1300W	216W	56V	-3
	Pins 4±	6 x 2431H	5.7Ω	1300W	216W	56V	-3
<b>Ch 1. MA-5002VZ Ch2.</b>	Pins 3±	12 x 2106H	2.7Ω	2000W	167W	112V	3
	Pins 3±	12 x 2106H	2.7Ω	2000W	167W	112V	3
<b>Ch 1. MA-5002VZ Ch2.</b>	Pins 2±	3 x 2262H	2.7Ω	2000W	667W	130V	2
	Pins 2±	3 x 2262H	2.7Ω	2000W	667W	130V	2
<b>Ch 1. MA-5002VZ Ch2.</b>	Pins 1±	3 x 2262H	2.7Ω	2000W	667W	130V	2
	Pins 1±	3 x 2262H	2.7Ω	2000W	667W	130V	2

**NOTE:**

If MA-3600 with 1.4V input sensitivity were used for the HF section, the same limiter threshold would apply. Users might need to re-adjust DSP output gain.

**Please refer to: NOTES REGARDING LIMITER SETTINGS on page 5.**

# JBL VERTEC VT4888 LINE ARRAY

## POWER AMPLIFIER CONFIGURATIONS - 4 BOX ARRAY

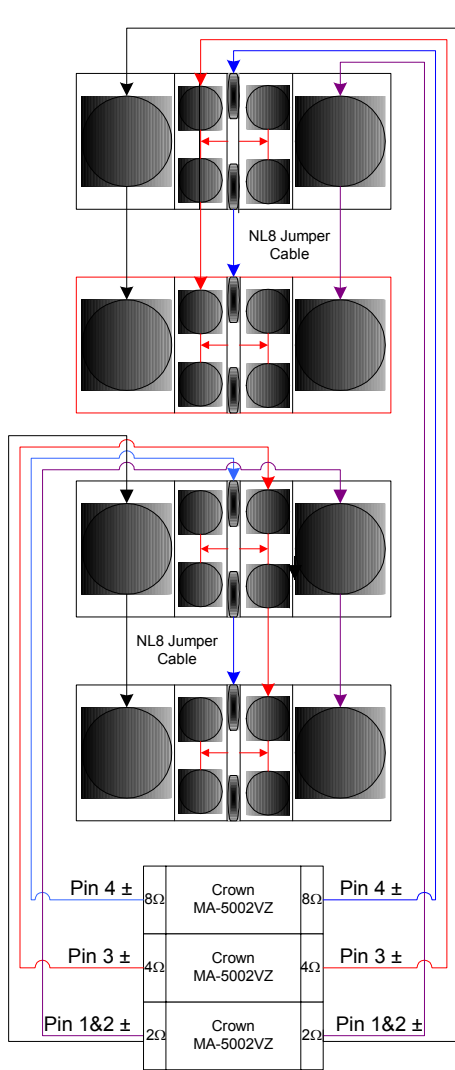

3 x Power Amplifiers  
(2Ω Load on LF Passband)

OR

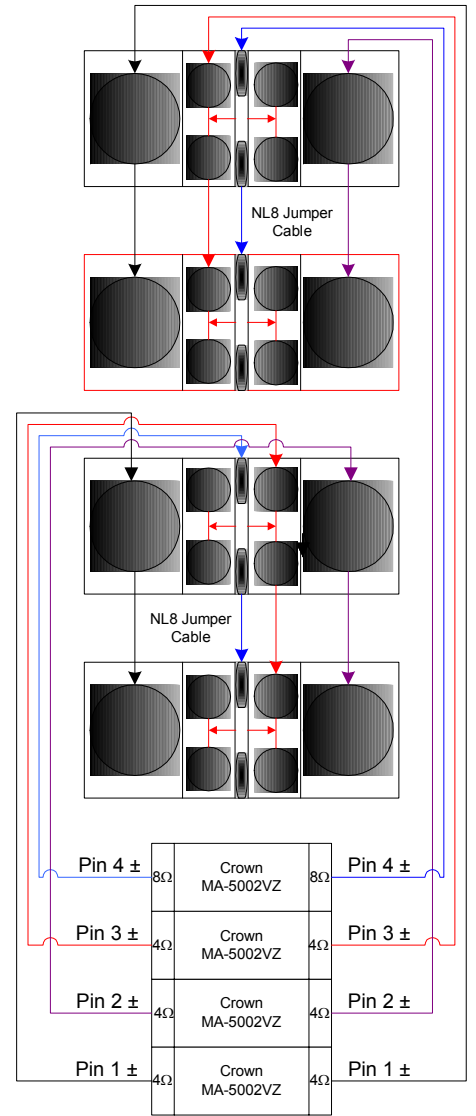

4 x Power Amplifiers  
(recommended)

### IMPORTANT NOTES:

All wiring configurations shown above use 8-conductor speaker cables terminated with Neutrik NL8 "Speakons". Ensure that each conductor in the cable is a minimum of #13 AWG gauge (3-4 mm).

### JBL VT4888:

The HF section of a VT4888 has **two** 2431H drivers (8Ω) wired in Series.

=16Ω

Pins 4±

The MF section of a VT4888 has **four** 2106H drivers (8Ω) wired in Series / Parallel.

=8Ω

Pins 3±

The LF section of a VT4888 has **two** 2262H drivers (8Ω) wired Independently.

=8Ω / 8Ω

Pins 1±, 2±

## VT4889 TRANSDUCER COMPLEMENT:

	Model	Speakon NL8 Terminals	Per box	Nominal Impedance per Transducer	Nominal Impedance per Passband	AES Power 100 HR Rating per Transducer	Peak Power Rating per Transducer	Recommended Power per Passband
HF	2435H	Pins 4±	x 3	5.3Ω	16Ω	75W	300W	300W
MF	2250H	Pins 3±	x 4	8Ω	8Ω	300W	1200W	1200W
LF	2255H	Pins 1± & 2±	x 2	8Ω	8Ω + 8Ω	600W	2400W	800W + 800W

## AMPLIFIER CONFIGURATIONS: 4 VT4889 / 3 MA-5002VZ

Amplifier Channel	Speakon NL8 Terminals	Driving	Nominal Impedance at Pins	Amplifier Power Rating at Nominal Impedance	Power Available to each Component	Bandpass Peak Voltage Vac	Limiter Threshold dBu
Ch 1. MA-5002VZ Ch2.	Pins 4±	6 x 2435H	8Ω	1300W	217W	100V	2.5
	Pins 4±	6 x 2435H	8Ω	1300W	217W	100V	2.5
Ch 1. MA-5002VZ Ch2.	Pins 3±	8 x 2250H	4Ω	2000W	250W	150V	2.5
	Pins 3±	8 x 2250H	4Ω	2000W	250W	150V	2.5
Ch 1. MA-5002VZ Ch2.	Pins 1± & 2±	4 x 2255H	2Ω	2500W	625W	120V	3.5
	Pins 1± & 2±	4 x 2255H	2Ω	2500W	625W	120V	3.5

## AMPLIFIER CONFIGURATIONS: 4 VT4889 / 4 MA-5002VZ

Amplifier Channel	Speakon NL8 Terminals	Driving	Nominal Impedance at Pins	Amplifier Power Rating at Nominal Impedance	Power Available to each Component	Bandpass Peak Voltage Vac	Limiter Threshold dBu
Ch 1. MA-5002VZ Ch2.	Pins 4±	6 x 2435H	8Ω	1300W	217W	100V	2.5
	Pins 4±	6 x 2435H	8Ω	1300W	217W	100V	2.5
Ch 1. MA-5002VZ Ch2.	Pins 3±	8 x 2250H	4Ω	2000W	250W	150V	2.5
	Pins 3±	8 x 2250H	4Ω	2000W	250W	150V	2.5
Ch 1. MA-5002VZ Ch2.	Pins 2±	2 x 2255H	4Ω	2000W	1000W	120V	3.5
	Pins 2±	2 x 2255H	4Ω	2000W	1000W	120V	3.5
Ch 1. MA-5002VZ Ch2.	Pins 1±	2 x 2255H	4Ω	2000W	1000W	120V	3.5
	Pins 1±	2 x 2255H	4Ω	2000W	1000W	120V	3.5

## **AMPLIFIER CONFIGURATIONS: 6 VT4889 / 4 MA-5002VZ**

Amplifier Channel	Speakon NL8 Terminals	Driving	Nominal Impedance at Pins	Amplifier Power Rating at Nominal Impedance	Power Available to each Component	Bandpass Peak Voltage Vac	Limiter Threshold dBu
Ch 1. MA-5002VZ Ch2.	Pins 4±	9 x 2435H	5.7Ω	1300W	145W	100V	2.5
	Pins 4±	9 x 2435H	5.7Ω	1300W	145W	100V	2.5
Ch 1. MA-5002VZ Ch2.	Pins 3±	12 x 2250H	2.7Ω	2000W	167W	150V	2.5
	Pins 3±	12 x 2250H	2.7Ω	2000W	167W	150V	2.5
Ch 1. MA-5002VZ Ch2.	Pins 2±	3 x 2255H	2.7Ω	2000W	667W	120V	3.5
	Pins 2±	3 x 2255H	2.7Ω	2000W	667W	120V	3.5
Ch 1. MA-5002VZ Ch2.	Pins 1±	3 x 2255H	2.7Ω	2000W	667W	120V	3.5
	Pins 1±	3 x 2255H	2.7Ω	2000W	667W	120V	3.5

## **VT4880 TRANSDUCER COMPLEMENT:**

	Model	Speakon NL4 Terminals	Per box	Nominal Impedance per Transducer	Nominal Impedance per Passband	AES Power 100 HR Rating per Transducer	Peak Power Rating per Transducer	Recommended Power per Passband
VLF	2 x 2258H	Pins 1± & 2±	x 2	8Ω	8Ω + 8Ω	800w	3200W	1600W

## **AMPLIFIER CONFIGURATIONS: 2 VT4880 / 1 MA-5002VZ**

Amplifier Channel	Speakon NL4 Terminals	Driving	Nominal Impedance at Pins	Amplifier Power Rating at Nominal Impedance	Power Available to each Bandpass	Bandpass Peak Voltage Vac	Limiter Threshold dBu
Ch 1. MA-5002VZ Ch2.	Pins 1± & 2±	2 x 2258H	4Ω	2000W	900W	120V	3.5
	Pins 1± & 2±	2 X 2258H	4Ω	2000W	900W	120V	3.5

**Please refer to: NOTES REGARDING LIMITER SETTINGS on page 5.**

# JBL VERTEC VT4889 LINE ARRAY

## POWER AMPLIFIER CONFIGURATIONS - 4 BOX ARRAY

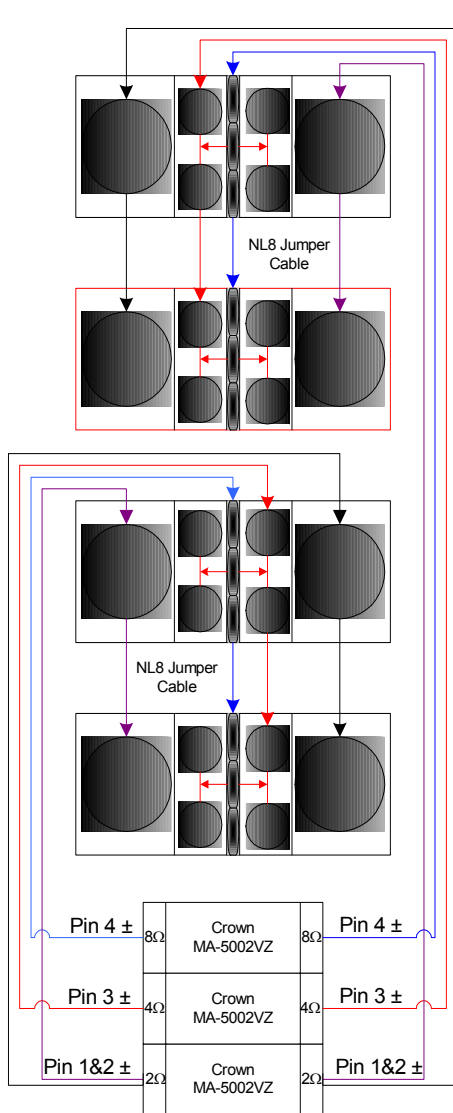

3 x Power Amplifiers  
(2Ω Load on LF Passband)

OR

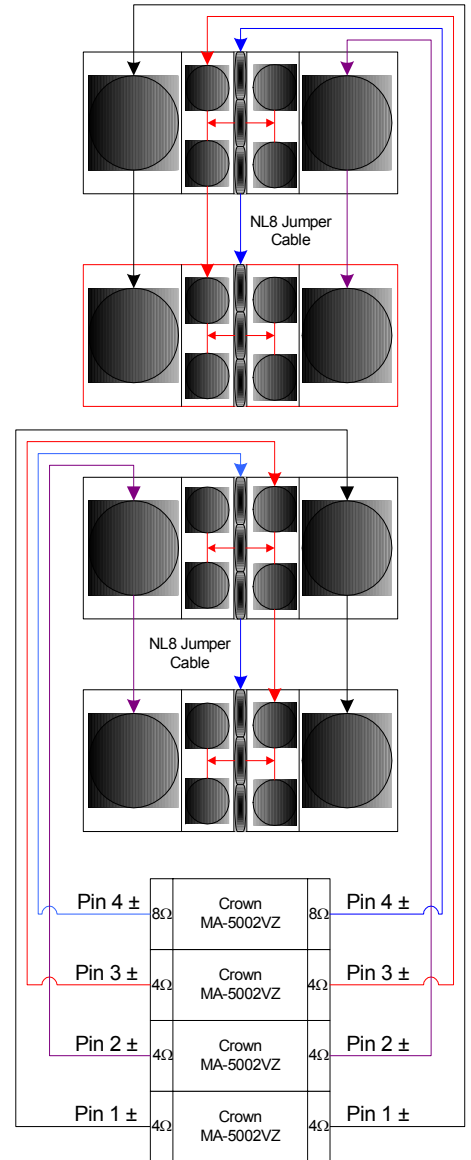

4 x Power Amplifiers  
(recommended)

### IMPORTANT NOTES:

All wiring configurations shown above use 8-conductor speaker cables terminated with Neutrik NL8 "Speakons". Ensure that each conductor in the cable is a minimum of #13 AWG gauge (3-4 mm).

### JBL VT4889:

The HF section of a VT4889 has **three** 2435H drivers (5.3Ω) wired in Series.

The MF section of a VT4889 has **four** 2250H drivers (8Ω) wired in Series / Parallel.

The LF section of a VT4889 has **two** 2255H drivers (8Ω) wired Independently.

=16Ω

=8Ω

=8Ω / 8Ω

Pins 4±

Pins 3±

Pins 1±, 2±

# **VERTEC SYSTEMS**

## **SUSPENSION HARDWARE & ASSEMBLY NOTES**

### **Arrays of similar VERTEC Model**

- Each VERTEC model uses the matching model of Array Frame (VT488X-AF) or Short Frame (VT488X-SF) to create clusters of the same model.
- These same frames can also be used to ground stack the various systems.

### **Arrays of Combined VERTEC Models**

- Clusters of combined models (i.e. VT4887s attached under a VT4889) use ADAPTER FRAMES to interconnect the various models.
- These frames are the:
  - VT4800-DA to adapt VT4887 under VT4889 or VT4880.
  - VT4800-CA to adapt VT4887 under VT4888.
  - VT4800-UA to adapt any model to any model.

### **Ground stacking capabilities**

- All VERTEC models can be ground stacked using the matching model of AF or SF frames.
- Up to 6 VERTEC cabinets can be safely stacked using the appropriate VERTEC AF frame and up to 4 cabinets when using the SF Frame.

### **General rigging recommendations**

- Only qualified personnel should perform suspension of audio systems!
- Users should inspect every component to be rigged every time the system is used.
- Users should verify that all Quick Release Pins in the VERTEC cabinets and in the suspension frames are properly locked when rigging the system.

## VERTEC SYSTEMS SUSPENSION FRAMES & HINGE BARS

<b>VERTEC MODEL</b>	<b>FRAME MODELS</b>	<b>NOTES</b>	<b>HINGE Part #</b>
<b>VT4889</b>	VT4889-AF VT4889-SF VT4800-UA VT4800-DA	Standard long frame. 16 VT4889 @ 7:1 DF* Standard short frame. 16 VT4889 @ 7:1 DF Universal frame to hang any model to any model. Adapter frame to hang 4 VT4887 under VT4889	336892-001 (4889 FRONT HINGE) 339693-001 (4889 REAR HINGE) 339644-001 (4889 REAR HINGE FOR UA ADAPTER)
<b>VT4880</b>	VT4889-AF VT4889-SF VT4800-UA VT4800-DA	Standard long frame. 18 VT4880 @ 7:1 DF Standard short frame. 18 VT4880 @ 7:1 DF Universal frame to hang any model to any model. Adapter frame to hang 4 VT4887 under VT4880	336892-001 (4889 FRONT HINGE) 339693-001 (4889 REAR HINGE) 339644-001 (4889 REAR HINGE FOR UA ADAPTER)
<b>VT4888</b>	VT4888-AF VT4888-SF VT4800-UA VT4800-CA	Standard long frame. 18 VT4888 @ 7:1 DF Standard short frame. 18 VT4888 @ 7:1 DF Universal frame to hang any model to any model. Adapter frame to hang VT4887 under VT4888	350597-001 (4888 FRONT HINGE) 338515-001 (4888 REAR HINGE) 339643-001 (4888 REAR HINGE FOR ADAPTERS)
<b>VT4887</b>	VT4887-AF VT4887-SF VT4800-UA VT4800-CA VT4800-DA	Standard long frame. 18 VT4887 @ 7:1 DF Standard short frame. 18 VT4887 @ 7:1 DF Universal frame to hang any model to any model. Adapter frame to hang VT4887 under VT4888 Adapter frame to hang 4 VT4887 under VT4889	350551-001 (4887/81 FRONT HINGE) 350342-001 (4887 REAR HINGE)
<b>VT4881</b>	VT4887-AF VT4887-SF VT4800-UA VT4800-CA	Standard long frame. 12 VT4881 @ 7:1 DF Standard short frame. 12 VT4881 @ 7:1 DF Universal frame to hang any model to any model. Adapter frame to hang VT4881 under VT4888 **VT4887 hang directly under the VT4881	350551-001 (4887/81 FRONT HINGE) 350552-001 (4881 REAR HINGE)

\* DF = Design Factor.

Please refer to JBL Technical Notes Volume 1, Number 14 *Basic Principles for Suspending Loudspeaker Systems* (available at [www.jblpro.com](http://www.jblpro.com)).

# VERTEC VT4888, VT4887, VT4881 SYSTEMS: SUSPENSION FRAMES

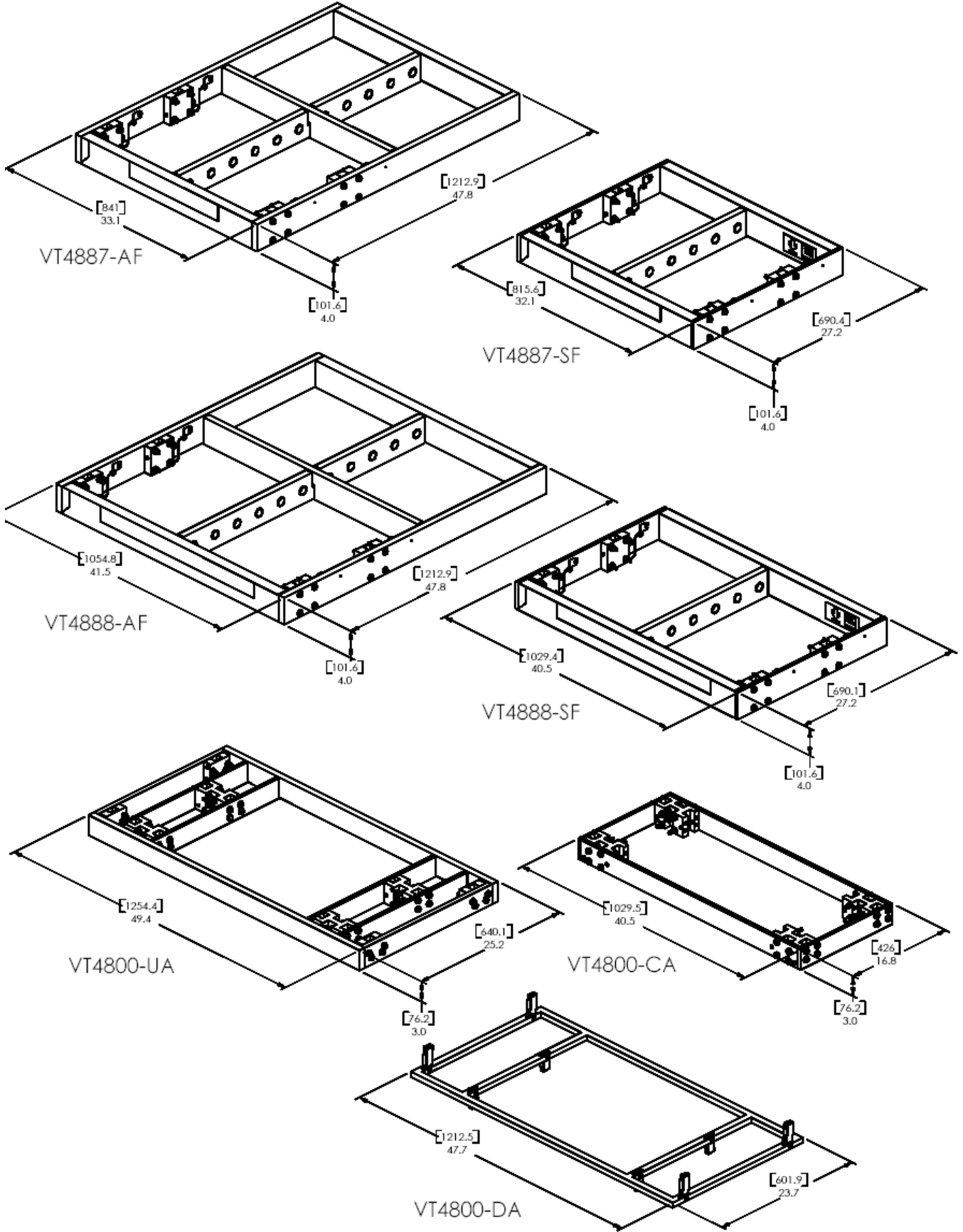



## VERTEC SYSTEMS: SUSPENSION HINGE BARS

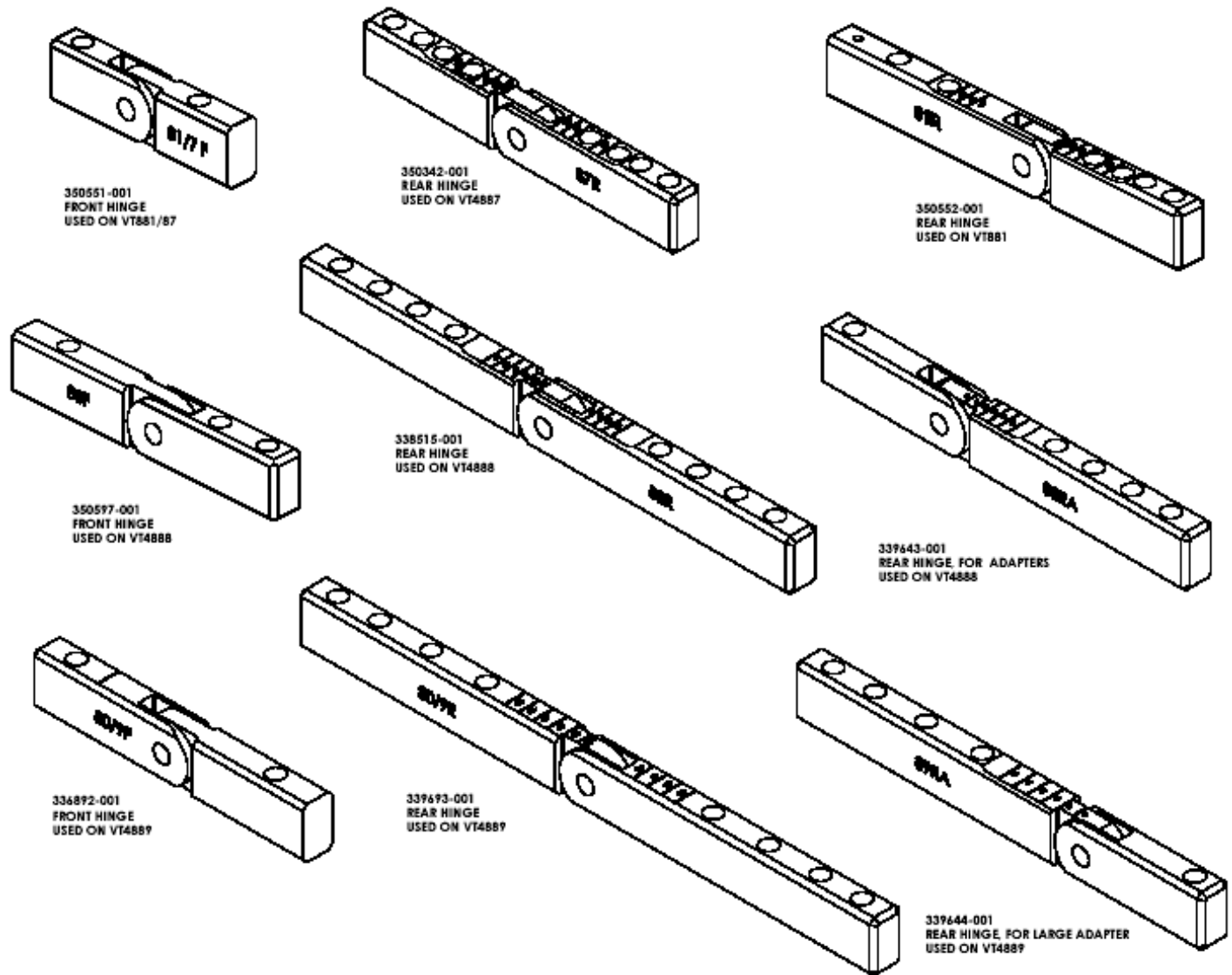

High-grade steel alloy hinge bars are used to couple adjacent boxes together. There are several different types. To ensure ease and proper inter-connection, make certain that the correct hinge bar model is matched to the appropriate Array Frame or Short Frame as well as the correct VERTEC model.

**VT4889 WITH VT4887 ATTACHED USING VT4800-DA**

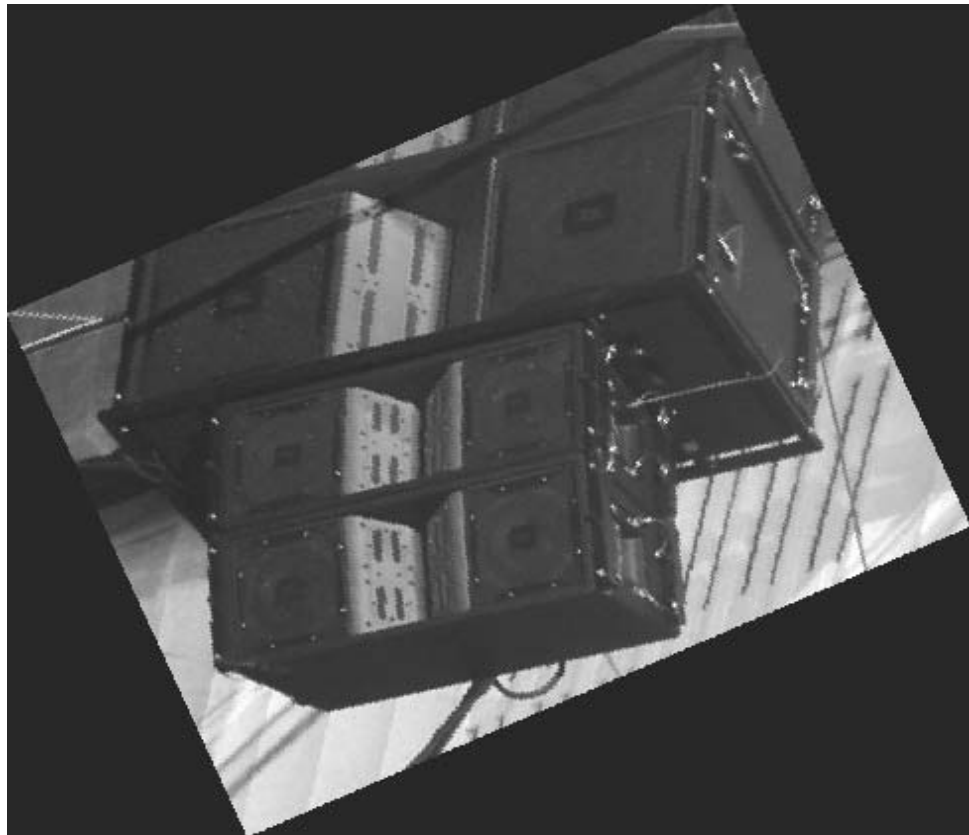

## TYPICAL 8-BOX HANGING ARRAY

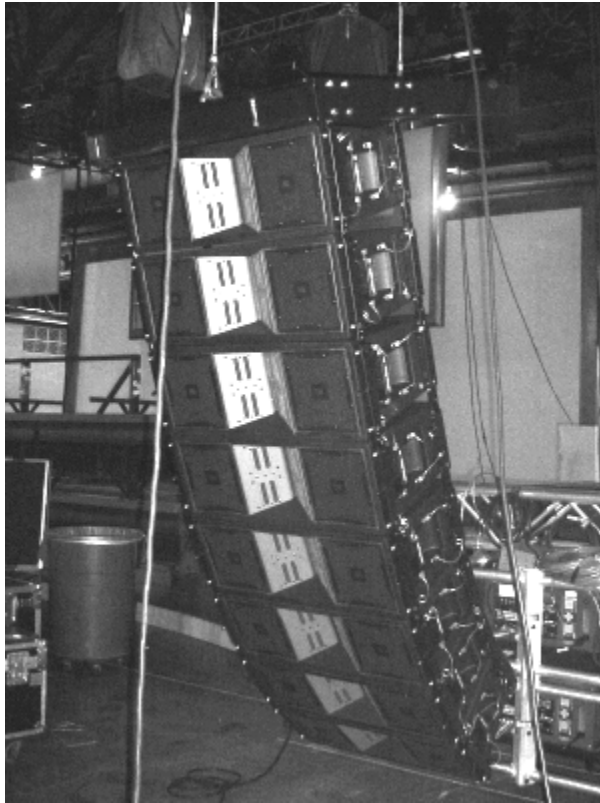

The VT4889 full size, the VT4888 mid size, and VT4887 compact line array elements can be suspended from either the “AF” (long) or “SF” (short) array frame. Shown here, eight VT4887 suspended from a VT4887-AF array frame.

## **VERTEC SUPPORT TEAM**

### **DIRECTOR, TOUR SOUND**

David Scheirman  
Office phone: (818) 895-3458  
Pager: (888) 861-1622  
Email address: [dscheirm@harman.com](mailto:dscheirm@harman.com)

### **TOUR SOUND PRODUCT MANAGER**

Raul Gonzalez  
Office phone: (818) 830-8749  
Mobile phone: (818) 802-9176  
Email address: [rgonzale@harman.com](mailto:rgonzale@harman.com)

### **DIRECTOR, SYSTEM DEVELOPMENT**

Mark Engebretson  
Office phone: (818) 895-5797  
Mobile phone: (818) 359-1594  
Email address: [mengebren@harman.com](mailto:mengebren@harman.com)

### **DIRECTOR, CUSTOM PROJECT MANAGEMENT**

Ted Leamy  
Office phone: (818) 830-8771  
Mobile phone: (818) 324-9389  
Email address: [tleamy@harman.com](mailto:tleamy@harman.com)

### **APPLICATIONS ENGINEERS**

#### **NORTH AMERICA**

Jay Fullmer, Applications Engineer  
Office phone: (818) 895-3473  
Mobile phone: (818) 324-8265  
Email address: [jfullmer@harman.com](mailto:jfullmer@harman.com)

#### **EUROPE**

Mark Bailey, Market Development Engineer  
Office phone: 44-173-764-4942  
Mobile phone: 44-777-581-6456  
Email address: [mbailey@harman.com](mailto:mbailey@harman.com)

#### **ASIA**

David Fuller, Market Development Engineer  
Office phone: 644-298-8669  
Mobile phone: 642-929-88669  
Email address: [dfuller@harman.com](mailto:dfuller@harman.com)

#### **SOUTH AMERICA & CARIBBEAN**

Rafael Quintero, Dir of Sales, Intercontinental  
Office phone: 818-895-3469  
Email address: [rquinter@harman.com](mailto:rquinter@harman.com)

## **WEBLINKS**

**JBL PROFESSIONAL:** [www.jblpro.com](http://www.jblpro.com)  
**VERTEC PRODUCTS:** [www.jblpro.com/vertec1/new\\_vertec/](http://www.jblpro.com/vertec1/new_vertec/)  
**JBL CUSTOMER SERVICE:** [www.jblproservice.com](http://www.jblproservice.com)

**VERTEC EMAIL ADDRESS:** [vertec@harman.com](mailto:vertec@harman.com)  
**CROWN AMPLIFIERS:** [www.crownaudio.com](http://www.crownaudio.com)



**PROFESSIONAL**

**JBL Professional**  
**8500 Balboa Blvd.**  
**Northridge, CA 91329**  
**818-894-8850**