

XNP693

XNP653

XNP553

SBX693

SBX653

SBX553



illuminITE™ XNP-SBX SERIES

INSTALLATION/OWNER'S MANUAL

Car Audio Speakers

DUAL AUDIO
LOUD & CLEAR







Getting Started

Thanks for choosing Dual. This manual is designed to provide information for the purchaser of Dual car audio products. Dual has attempted to make sure all the information in this manual is current. But, this information is subject to change without notice.

Safety

 **CAUTION** This symbol with "CAUTION" is intended to alert the user to the presence of important instructions. Failure to heed the instructions can result in injury or unit damage.

 **CAUTION** To prevent injury and damage to the unit, please read and follow the instructions in this manual.

 **CAUTION** If you feel unsure about installing this system yourself, have it installed by a qualified audio technician.

 **CAUTION** Before installation, disconnect the battery negative (-) terminal to prevent damage to the unit, fire and/or possible injury.

 **CAUTION** Do not connect Amplifier or any audio source to illumination inputs. Inputs are designed for 12 volt power source only. More than 3Vrms connected to illumination inputs may cause permanent damage to the lighting elements.

Installation

Please Note: Some Full Range Speakers are most often used as direct replacements for stock speakers and are shipped without grilles or grilles may not be required. Parts of the following instructions may not apply to your installation.

 **CAUTION** The installation instructions included here are basic. If you feel unsure about installing the speaker system, Dual recommends that you seek installation by a qualified auto sound technician.

Before installation, please follow these rules:

1. Be sure to carefully read and understand the instructions before attempting to install the product.
2. For safety, disconnect the negative lead from the battery prior to beginning the installation.
3. For easier assembly, we recommend that if additional wiring is required, that you run all wires prior to mounting your speaker in place.
4. Use the highest quality connectors for a reliable installation and to minimize signal or power loss.
5. Use caution before you drill or cut! Be careful not to cut or drill into gas tanks, fuel lines, brake or hydraulic lines, vacuum lines or electrical wiring when working on any vehicle.
6. Never run speaker wires underneath your vehicle. Running speaker wires inside the vehicle provides the best protection from exhaust heat and environmental elements.
7. Avoid running wires over, near, or through sharp edged surfaces. We suggest you also use rubber grommets to protect any wires routed through metal, especially the firewall.
8. Do not connect audio outputs from your amp or receiver to the Illuminite inputs of the speakers. This WILL DAMAGE the LED bulbs and WILL void your warranty.



illuminate™ Lighting Hook-Up Recommendations

The illuminate lighting elements of your XiN series products provide you with a unique custom touch to your vehicle. Dual's patent pending illuminate bulb system and control circuitry provides an extraordinary lighted-Hue illumination which allows great creative opportunities for the beginner and seasoned custom installer alike. The interior of your vehicle will never sound or look ordinary again. Let your imagination take you there.

The lighting features of all illuminate products require a 12 volt power source to operate. The speaker has two distinct sets of input terminals. The first is labeled audio input terminals and the second is labeled illuminate lighting inputs. The inputs are clearly marked with a label positioned directly above the terminal housing. The polarity (+ and -) indicators for each set of inputs also appear on these labels.

1. Do not connect Amplifier or any audio source to illuminate lighting inputs. Inputs are designed for switched 12 volt power source only. More than 3V rms connected to illumination inputs can cause permanent damage to the lighting elements.
2. See fig. 1a, (illustrates wiring diagram) be sure to maintain polarity. Be sure to connect to a constant switched 12 volt source. Correct connection would be the positive (+) 12 volt wire to the Positive (+) illuminate Lighting input terminal and connect the Negative (-) illuminate lighting input terminal to a good chassis ground.

Fig 1a

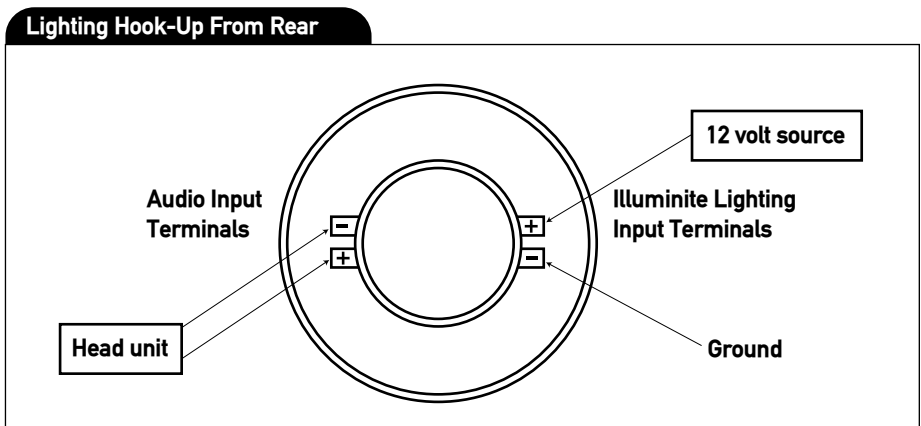

Notice: The illuminate™ series LED illumination elements are not removable. There are no serviceable parts inside or attached to the speaker assembly. The illuminate™ series products are sensitive electronic devices. Removal or tampering with any part or portion of the speaker and/or its assemblies will damage the product and void the limited warranty.

Mounting

1. Determine where the speakers will be mounted. Ensure an area large enough for the speaker to mount evenly. Be sure that the mounting location is deep enough for the speaker to fit.
2. Refer to the specification chart to determine the proper diameter hole to cut for your speaker model.
3. If supplied, use the plastic mounting ring as a template to mark the locations for the mounting screws. Drill the holes with a 1/8" bit.
4. Be sure to observe proper polarity when connecting the wires. The speaker's positive terminal is indicated with the "+" symbol.
5. Fit the ring and speaker to the cut-out. Mount them using the enclosed screws. If supplied, fit the grille inside the ring and press gently, but firmly, into place and attach with screws.

Standard Rear Deck Installation

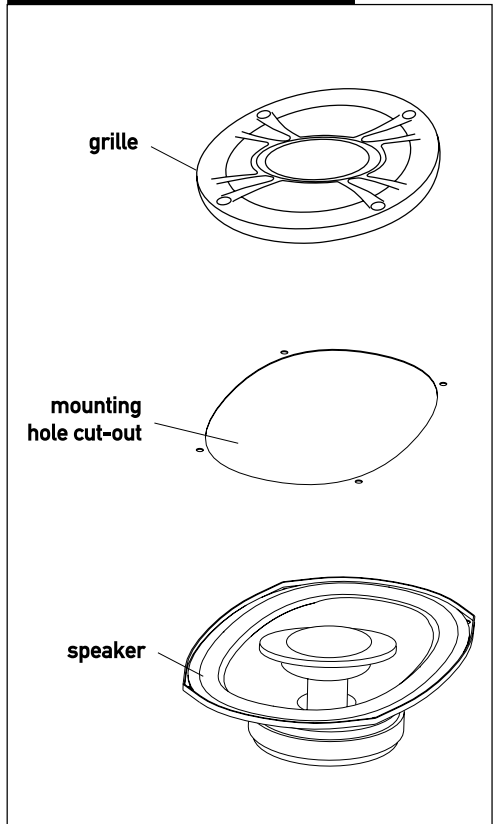

Standard Door Installation

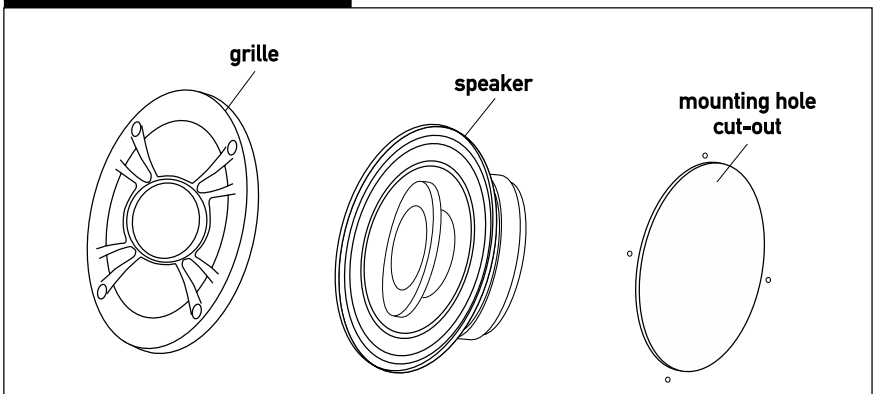



Mounting Legend

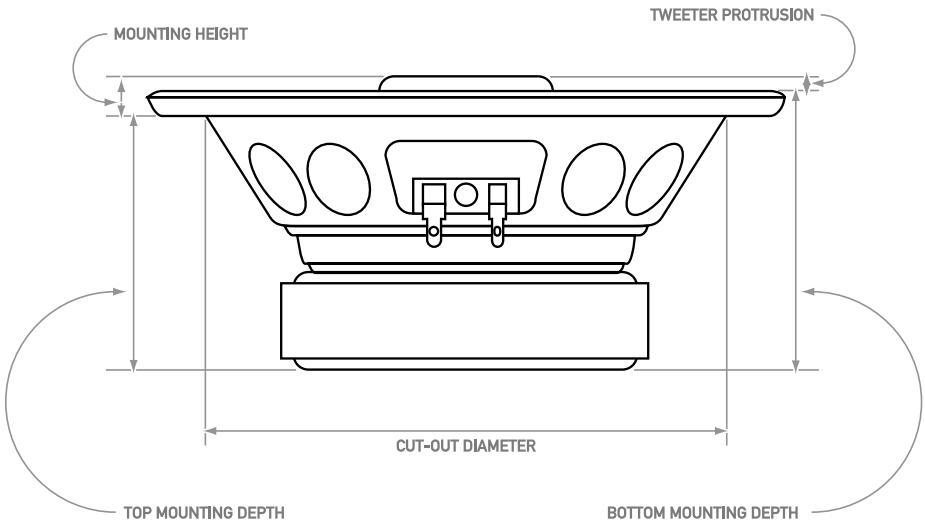



Notes



XNP - SBX SERIES WARRANTY

Limited One-Year Warranty

This warranty gives you specific legal rights. You may also have other rights which vary from state to state.

Namsung America Inc. warrants this product to the original purchaser to be free from defects in material and workmanship, under normal conditions, for a period of one year from the date of the original purchase.

Namsung America agrees, at our option, during the warranty period, to repair any defect in material or workmanship or to furnish an equal new or renewed product in exchange without charges, subject to verification of the defect or malfunction and proof of the date of purchase.

During the One-Year Warranty Period: For One Year from the date of purchase, your product will be replaced with a new, renewed or comparable product (whichever is deemed necessary) if it becomes defective or inoperative. This is done without charge to you. Replacement products are warranted for the balance of the original warranty period.

Who is covered? This warranty is extended to the original retail purchaser for products purchased and used in the U.S.A., in the 48 contiguous states ONLY.

What is covered? This warranty covers all defects in material and workmanship in this product. The following are not covered: installation/removal costs, damage resulting from accident, misuse, abuse, neglect, product modification, improper installation, incorrect line voltage, unauthorized repair or failure to follow instructions supplied with the product, or damage occurring during return shipment of the product.

What to do?

1. Before you call for service, check your operating instruction booklet. A slight adjustment of any custom controls discussed in your instruction booklet may save you a service call.
2. If you require service during the warranty period, you must carefully pack the product (preferably in the original package) and ship it by prepaid transportation with proof of the purchase date from the retailer to the Return Center address listed below.
3. Please describe your problem in writing and include your name, a return UPS shipping address (P.O. Box not acceptable), and a daytime phone number with your shipment.
4. DUAL will pay the return shipping charges if the product is returned to an address within the USA.

Namsung America Inc.
Attn: Returns Center
21318 64th Ave. South
Kent, WA 98032 U.S.A.
Toll Free: 1-866-626-7863

Exclusion of Certain Damages: This warranty is exclusive and in lieu of any and all other warranties, expressed or implied, including without limitation the implied warranties of merchantability and fitness for a particular purpose and any obligation, liability, right, claim or remedy in contract or tort, whether or not arising from the company's negligence, actual or imputed. No person or representative is authorized to assume for the company any other liability in connection with the sale of this product. In no event shall the company be liable for indirect, incidental or consequential damages.



Dual Electronics Corporation
21318 64th Avenue South
Kent, WA 98032 U.S.A
©2005 Dual Electronics Corp.
www.dualav.com