

Makita

Finishing Sander

MODEL B04550

MODEL B04550Z

Without dust bag
and punch plate

INSTRUCTION MANUAL



SPECIFICATIONS

Pad size	No load speed (OPM)	Dimensions (L x W x H)	Net weight
112 mm x 100 mm (4-3/8" x 4")	14,000	115 mm x 112 mm x 130 mm (4-1/2" x 4-3/8" x 5-1/8")	0.95 kg (2.1 lbs)

- Manufacturer reserves the right to change specifications without notice.
- Note: Specifications may differ from country to country.

IMPORTANT SAFETY INSTRUCTIONS

(For All Tools)

WARNING: WHEN USING ELECTRIC TOOLS, BASIC SAFETY PRECAUTIONS SHOULD ALWAYS BE FOLLOWED TO REDUCE THE RISK OF FIRE, ELECTRIC SHOCK, AND PERSONAL INJURY, INCLUDING THE FOLLOWING:

READ ALL INSTRUCTIONS.

- 1. KEEP WORK AREA CLEAN.** Cluttered areas and benches invite injuries.
- 2. CONSIDER WORK AREA ENVIRONMENT.** Don't use power tools in damp or wet locations. Keep work area well lit. Don't expose power tools to rain. Don't use tool in presence of flammable liquids or gases.
- 3. KEEP CHILDREN AWAY.** All visitors should be kept away from work area. Don't let visitors contact tool or extension cord.
- 4. STORE IDLE TOOLS.** When not in use, tools should be stored in dry, and high or locked-up place — out of reach of children.
- 5. DON'T FORCE TOOL.** It will do the job better and safer at the rate for which it was intended.
- 6. USE RIGHT TOOL.** Don't force small tool or attachment to do the job of a heavy-duty tool. Don't use tool for purpose not intended.
- 7. DRESS PROPERLY.** Don't wear loose clothing or jewelry. They can be caught in moving parts. Rubber gloves and non-skid footwear are recommended when working outdoors. Wear protective hair covering to contain long hair.
- 8. USE SAFETY GLASSES.** Also use face or dust mask if cutting operation is dusty.
- 9. DON'T ABUSE CORD.** Never carry tool by cord or yank it to disconnect from receptacle. Keep cord from heat, oil, and sharp edges.
- 10. SECURE WORK.** Use clamps or a vise to hold work. It's safer than using your hand and it frees both hands to operate tool.
- 11. DON'T OVERREACH.** Keep proper footing and balance at all times.
- 12. MAINTAIN TOOLS WITH CARE.** Keep tools sharp and clean for better and safer performance. Follow instructions for lubricating and changing accessories. Inspect tool cords periodically and if damaged, have repaired by authorized service facility. Inspect extension cords periodically and replace if damaged. Keep handles dry, clean, and free from oil and grease.
- 13. DISCONNECT TOOLS.** When not in use, before servicing, and when changing accessories, such as blades, bits, cutters.

14. **REMOVE ADJUSTING KEYS AND WRENCHES.** Form habit of checking to see that keys and adjusting wrenches are removed from tool before turning it on.
15. **AVOID UNINTENTIONAL STARTING.** Don't carry plugged-in tool with finger on switch. Be sure switch is OFF when plugging in.
16. **OUTDOOR USE EXTENSION CORDS.** When tool is used outdoors, use only extension cords intended for use outdoors and so marked.
17. **STAY ALERT.** Watch what you are doing, use common sense. Don't operate tool when you are tired.
18. **CHECK DAMAGED PARTS.** Before further use of the tool, a guard or other part that is damaged should be carefully checked to determine that it will operate properly and perform its intended function. Check for alignment of moving parts, binding of moving parts, breakage of parts, mounting, and any other conditions that may affect its operation. A guard or other part that is damaged should be properly repaired or replaced by an authorized service center unless otherwise indicated elsewhere in this instruction manual. Have defective switches replaced by authorized service center. Don't use tool if switch does not turn it on and off.
19. **GUARD AGAINST ELECTRIC SHOCK.** Prevent body contact with grounded surfaces. For example; pipes, radiators, ranges, refrigerator enclosures.
20. **REPLACEMENT PARTS.** When servicing, use only identical replacement parts.
21. **POLARIZED PLUGS:** To reduce the risk of electric shock, this equipment has a polarized plug (one blade is wider than the other). This plug will fit in a polarized outlet only one way. If the plug does not fit fully in the outlet, reverse the plug. If it still does not fit, contact a qualified electrician to install the proper outlet. Do not change the plug in any way.

VOLTAGE WARNING: Before connecting the tool to a power source (receptacle, outlet, etc.) be sure the voltage supplied is the same as that specified on the nameplate of the tool. A power source with voltage greater than that specified for the tool can result in **SERIOUS INJURY** to the user — as well as damage to the tool. If in doubt, **DO NOT PLUG IN THE TOOL.** Using a power source with voltage less than the name plate rating is harmful to the motor.

ADDITIONAL SAFETY RULES

1. Hold the tool firmly.
2. Do not leave the tool running. Operate the tool only when hand-held.
3. This tool has not been waterproofed, so do not use water on the workpiece surface.

SAVE THESE INSTRUCTIONS.

Attaching abrasive paper

CAUTION:

Always be sure that the tool is switched off and unplugged before installing or removing the paper.

Raise the lever. Insert the paper end into the clamber, aligning the paper edges even and parallel with the sides of the base. (Prebending the paper makes attachment easier.) Once the paper is in place, return the lever to its original position.

Repeat the same process for the other end of the base, maintaining the proper paper tension.

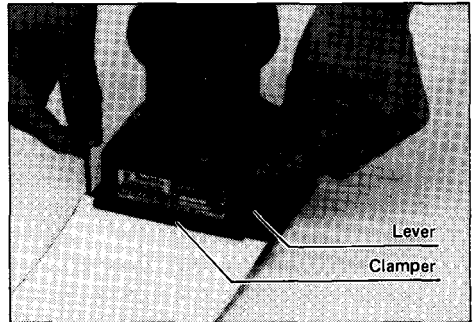

CAUTION:

After inserting the paper, make sure the teeth of the clamber hold it securely. Otherwise the paper will be loose and subject to slippage, resulting in uneven sanding operation.

Punch plate

(standard equipment for Model BO4550 optional accessory for Model BO4550Z)

When using the dust bag, make holes in the paper using the punch plate as follows: Hold the tool with the paper surface facing up. Place the punch plate over the paper so that the bent sides of the punch plate are flush with the paper edges. Then press the punch plate to make holes in the paper.

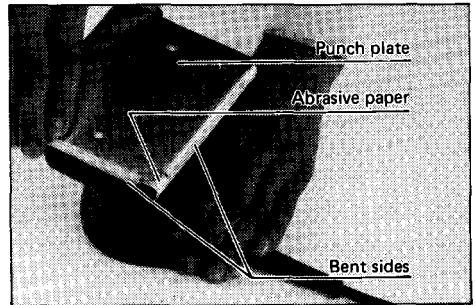

CAUTION:

Be sure to remove the punch plate before operation.

Dust bag

(standard equipment for Model BO4550 optional accessory for Model BO4550Z)

The use of the dust bag makes sanding operations clean and dust collection easy. To attach the dust bag, fit the bag's entry port onto the dust spout on the tool so that the hole in the entry port is just over the protrusion on the dust spout.

For the best results, empty the dust bag when it becomes about half full, tapping it lightly to remove as much dust as possible.

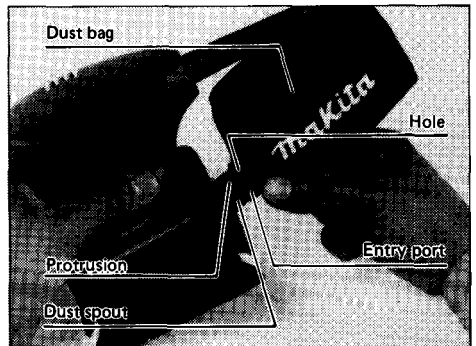

Switch action

To start the tool, move the switch to the "ON" position. To stop, move the switch to the "OFF" position.

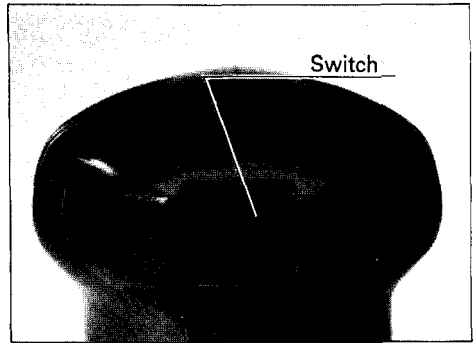

Operation

Hold the tool firmly. Turn the tool on and wait until it attains full speed. Then gently place the tool on the workpiece surface. A finishing sander is generally used to remove only a small amount of material at a time. Since the quality of the surface is more important than the amount of stock removed, do not bear down on the tool. Keep the base flush with the workpiece at all times. Excessive pressure may damage the paper and shorten tool life.



CAUTION:

- Do not block motor vent with your finger or hand.
- Never run the tool without paper. You may seriously damage the pad.

MAINTENANCE

CAUTION:

Always be sure that the tool is switched off and unplugged before attempting to perform inspection or maintenance.

The tool will stop when the carbon brushes wear to a certain length. When this occurs, both carbon brushes should be replaced.

To maintain product SAFETY and RELIABILITY, repairs, carbon brush inspection and replacement, any other maintenance or adjustment should be performed by Makita Authorized or Factory Service Centers, always using Makita replacement parts.

OPTIONAL ACCESSORIES

The accessories listed in this manual are available at an extra cost from your Makita distributor or Makita factory service center. Service centers are listed on the warranty card packed with your tool.

CAUTION:

These accessories or attachments are recommended for use with your Makita tool specified in this manual. The use of any other accessories or attachments might present a risk of injury to persons. The accessories or attachments should be used only in the proper and intended manner.

Abrasive papers

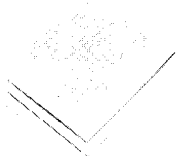

Grit	Part No.	use	Sheets per pack
60	742509-3	Coarse	10
100	742510-8	Medium	
150	742511-6	Fine	

• Dust bag

Part No. 166027-1



• Punch plate

Part No. 163247-8

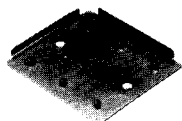

MODEL BO4550

ITEM NO.	NO. USED	DESCRIPTION	ITEM NO.	NO. USED	DESCRIPTION
<u>MACHINE</u>			<u>MACHINE</u>		
1	2	Bush Holder	17	4	Pan Head Screw M4x12 (With Washer)
2	2	Carbon Brush	18	1	Rubber Sleeve 48
3	1	Ball Bearing 626LLB	19	1	Flat Washer 6
4	1	ARMATURE ASSEMBLY (With Item 3, 4, 7, & 8)	20	1	Countersunk Head Screw M4x12
5	1	Housing Set (With Item 26)	21	2	Lever
6	1	FIELD ASSEMBLY	22	1	Base
7	1	Flat Washer 9	23	1	Dust Bag
8	1	Ball Bearing 629LLB	24	1	Cord
9	2	Tapping Screw BT 4x16	25	1	Switch
10	1	Name Plate	26	1	Housing Set (With Item 5)
11	1	Fan 63	27	1	Tapping Screw BT 4x40
12	1	Dust Seal 10	28	1	Tapping Screw BT 4x25
13	1	Ball Bearing 6200LLB	29	2	Tapping Screw BT 4x50
14	1	Fan Guide			
15	2	Foot			
16	2	Clamper			

FINISHING SANDER Model B04550 Model B04550Z

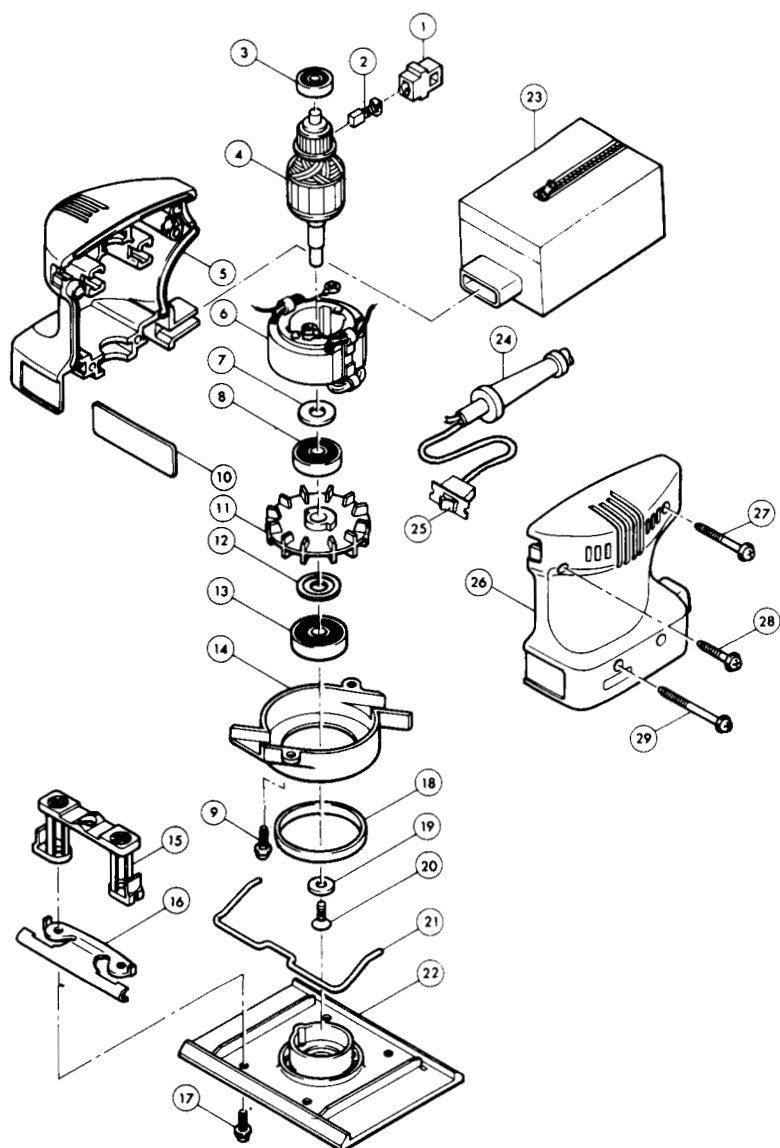

MAKITA LIMITED ONE YEAR WARRANTY

Warranty Policy

Every Makita tool is thoroughly inspected and tested before leaving the factory. It is warranted to be free of defects from workmanship and materials for the period of ONE YEAR from the date of original purchase. Should any trouble develop during this one-year period, return the COMPLETE tool, freight prepaid, to one of Makita's Factory or Authorized Service Centers. If inspection shows the trouble is caused by defective workmanship or material, Makita will repair (or, at our option, replace) without charge.

This Warranty does not apply where:

- repairs have been made or attempted by others
- repairs are required because of normal wear and tear
- the tool has been abused, misused or improperly maintained
- alterations have been made to the tool

In no event shall Makita be liable for any indirect, incidental or consequential damages from the sale or use of the product. This disclaimer applies both during and after the term of warranty.

Makita disclaims liability for any implied warranties, including implied warranties of "merchantability" and "fitness for a specific purpose", after the one-year term of this warranty.

This Warranty gives you specific legal rights, and you may also have the other rights which vary from state to state. Some states do not allow the exclusion or limitation of incidental or consequential damages, so the above limitation or exclusion may not apply to you. Some states do not allow limitation on how long an implied warranty lasts, so the above limitation may not apply to you.

Makita Corporation of America

2650 Gainesville Hwy., Buford, GA 30518