

Multi-CD control High power CD/MP3/WMA player with RDS tuner

Operation Manual

DEH-P4800MP

Visit www.pioneer.co.uk (or www.pioneer-eur.com)
to register your product

Pioneer *sound.vision.soul*

ENGLISH

Contents

Thank you for buying this Pioneer product

Please read through these operating instructions so you will know how to operate your model properly. After you have finished reading the instructions, keep this manual in a safe place for future reference.

Connecting the Units	3	RDS	11
Installation	5	Introduction of RDS operation	11
DIN Front/Rear-mount	5	Switching the RDS display	12
DIN Front-mount	5	Selecting alternative frequencies	12
• Installation with the rubber bush	5	• Using PI Seek	12
• Removing the Unit	5	• Using Auto PI Seek for	12
DIN Rear-mount	5	preset stations to regional	12
• Installation using the screw	5	programming	12
holes on the side of the unit	5	Receiving traffic announcements	12
Fixing the front panel	6	Receiving PTY alarm broadcasts	13
Before You Start	6	PTY list	13
About this unit	6	Built-in CD Player	14
About this manual	7	Playing a CD	14
In case of trouble	7	Introduction of advanced built-in	14
Features	7	CD player operation	14
About WMA	7	Repeating play	14
Visit our website	7	Playing tracks in random order	15
Protecting your unit from theft	8	Scanning tracks of a CD	15
• Removing the front panel	8	Pausing CD playback	15
• Attaching the front panel	8	Using compression and BMX	15
What's What	8	Selecting the search method	15
Head unit	8	Searching every 10 tracks in the	15
Optional remote control	9	current disc	15
Power ON/OFF	9	Using disc title functions	16
Turning the unit on	9	• Entering disc titles	16
Selecting a source	9	• Displaying disc titles	16
Turning the unit off	9	Using CD TEXT functions	16
Tuner	10	• Displaying text information on	16
Listening to the radio	10	CD TEXT discs	16
Introduction of advanced tuner	10	• Scrolling text information	16
operation	10	in the display	16
Storing and recalling broadcast	10	MP3/WMA/WAV Player	17
frequencies	10	Playing MP3/WMA/WAV	17
Tuning in strong signals	11	Introduction of advanced built-in	17
Storing the strongest broadcast	11	player (MP3/WMA/WAV) operation	17
frequencies	11	Repeating play	18
		Playing tracks in random order	18
		Scanning folders and tracks	18
		Pausing MP3/WMA/WAV playback	18
		Using compression and BMX	19
		Selecting the search method	19
		Searching every 10 tracks in the	19
		current folder	19
		Displaying text information on	19
		MP3/WMA/WAV disc	19
		• When playing back an	19
		MP3/WMA disc	19
		• When playing back a WAV disc	20
		Scrolling text information in the display	20

Multi-CD Player	20	Initial Settings	28
Playing a CD	20	Adjusting initial settings	28
50-disc multi-CD player	21	Setting the FM tuning step	28
Introduction of advanced multi-CD	21	Switching Auto PI Seek	29
player operation	21	Switching the auxiliary setting	29
Repeating play	21	Setting the rear output and subwoofer	29
Playing tracks in random order	21	controller	29
Scanning CDs and tracks	21	Saving the battery consumption	29
Pausing CD playback	22	Other Functions	30
Using ITS playlists	22	Using the AUX source	30
• Creating a playlist with ITS	22	• About AUX1 and AUX2	30
programming	22	• Selecting AUX as the source	30
• Playback from your ITS playlist	22	• Setting the AUX title	30
• Erasing a track from your	22	Additional Information	31
ITS playlist	22	Understanding built-in CD player	31
• Erasing a CD from your	22	error messages	31
ITS playlist	23	Sound muting	31
Using disc title functions	23	CD player and care	31
• Entering disc titles	23	CD-R/CD-RW discs	31
• Displaying disc titles	23	MP3, WMA and WAV files	32
Using CD TEXT functions	23	• MP3 additional information	32
• Displaying text information on	24	• WMA additional information	32
CD TEXT discs	24	• WAV additional information	33
• Scrolling text information	24	About folders and MP3/WMA/WAV files	33
in the display	24	Terms	33
Using compression and bass	24	Specifications	34
emphasis	24		
Audio Adjustments	24		
Introduction of audio adjustments	24		
Using balance adjustment	25		
Using the equalizer	25		
• Recalling equalizer curves	25		
• Adjusting equalizer curves	25		
• Fine-adjusting equalizer curve	26		
Adjusting loudness	26		
Using subwoofer output	26		
• Adjusting subwoofer settings	27		
Using the high pass filter	27		
Boosting the bass	27		
Front image enhancer (F.I.E.)	27		
Adjusting source levels	28		

Connecting the Units

Notes

- This unit is for vehicles with a 12-volt battery and negative grounding. Before installing it in a recreational vehicle, truck, or bus, check the battery voltage.
- To avoid shorts in the electrical system, be sure to disconnect the \ominus battery cable before beginning installation.
- Refer to the owner's manual for details on connecting the power amp and other units, then make connections correctly.
- Secure the wiring with cable clamps or adhesive tape. To protect the wiring, wrap adhesive tape around them where they lie against metal parts.
- Route and secure all wiring so it cannot touch any moving parts, such as the gear shift, handbrake and seat rails. Do not route wiring in places that get hot, such as near the heater outlet. If the insulation of the wiring melts or gets torn, there is a danger of the wiring short-circuiting to the vehicle body.
- Do not pass the yellow lead through a hole into the engine compartment to connect to the battery. This will damage the lead insulation and cause a very dangerous short.
- Do not shorten any leads. If you do, the protection circuit may fail to work when it should.
- Never feed power to other equipment by cutting the insulation of the power supply lead of the unit and tapping into the lead. The current capacity of the lead will be exceeded, causing overheating.
- When replacing the fuse, be sure to only use a fuse of the rating prescribed on this product.
- Since a unique BPTL circuit is employed, never wire so the speaker leads are directly grounded or the left and right \ominus speaker leads are common.
- Speakers connected to this unit must be highpower with minimum rating of 50 W and impedance of 4 to 8 ohms. Connecting speakers with output and/or impedance values other than those noted here may result in the speakers catching fire, emitting smoke or becoming damaged.
- When this product's source is switched ON, a control signal is output through the blue/white lead. Connect to an external power amp's system remote control or the car's Auto-antenna relay control terminal (max. 300 mA 12 V DC). If the car features a glass antenna, connect to the antenna booster power supply terminal.

- When an external power amp is being used with this system, be sure not to connect the blue/white lead to the amp's power terminal. Likewise, do not connect the blue/white lead to the power terminal of the auto-antenna. Such connection could cause excessive current drain and malfunction.
- To avoid short-circuiting, cover the disconnected lead with insulating tape. Insulate the unused speaker leads without fail. There is a possibility of a short-circuiting if the leads are not insulated.
- To prevent incorrect connection, the input side of the IP-BUS connector is blue, and the output side is black. Connect the connectors of the same colors correctly.
- If this unit is installed in a vehicle that does not have an ACC (accessory) position on the ignition switch, the red lead of the unit should be connected to a terminal coupled with ignition switch ON/OFF operations. If this is not done, the vehicle battery may be drained when you are away from the vehicle for several hours.



ACC position



No ACC position

- The black lead is ground. Please ground this lead separately from the ground of high-current products such as power amps. If you ground the products together and the ground becomes detached, there is a risk of damage to the products or fire.

• Cords for this product and those for other products may be different colors even if they have the same function. When connecting this product to another product, refer to the supplied manuals of both products and connect cords that have the same function.

ENGLISH

Connecting the Units

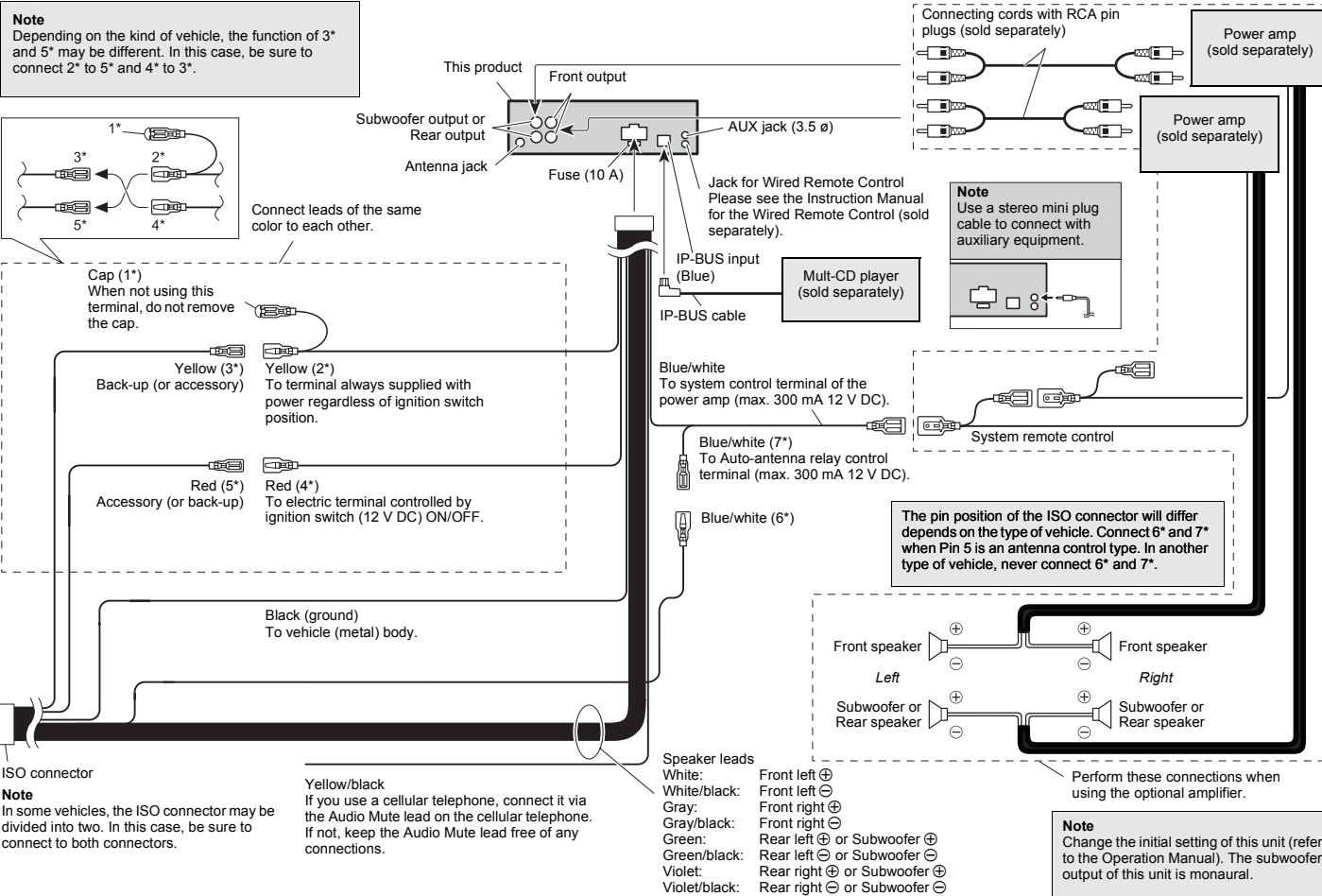

Installation

Notes

- Before making a final installation of the unit, temporarily connect the wiring to confirm that the connections are correct and the system works properly.
- Use only the parts included with the unit to ensure proper installation. The use of unauthorized parts can cause malfunctions.
- Consult with your nearest dealer if installation requires the drilling of holes or other modifications of the vehicle.
- Install the unit where it does not get in the driver's way and cannot injure the passenger if there is a sudden stop, like an emergency stop.
- The semiconductor laser will be damaged if it overheats, so don't install the unit anywhere hot – for instance, near a heater outlet.
- If installation angle exceeds 60° from horizontal, the unit might not give its optimum performance.

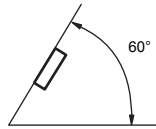

DIN Front/Rear-mount

This unit can be properly installed either from "Front" (conventional DIN Front-mount) or "Rear" (DIN Rear-mount installation, utilizing threaded screw holes at the sides of unit chassis). For details, refer to the following illustrated installation methods.

DIN Front-mount

Installation with the rubber bush

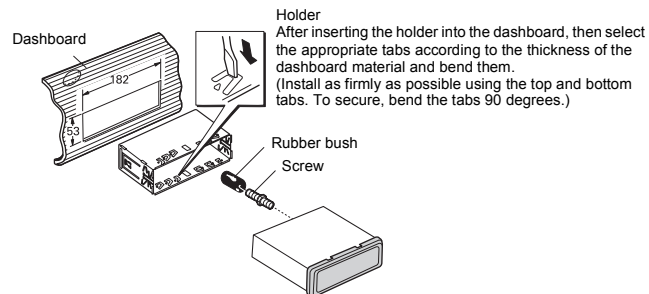

Removing the Unit

To remove the frame, extend top and bottom of the frame outwards in order to unlock it. (When reattaching the frame, point the side with a groove downwards and attach it.)

- It becomes easy to remove the frame if the front panel is released.

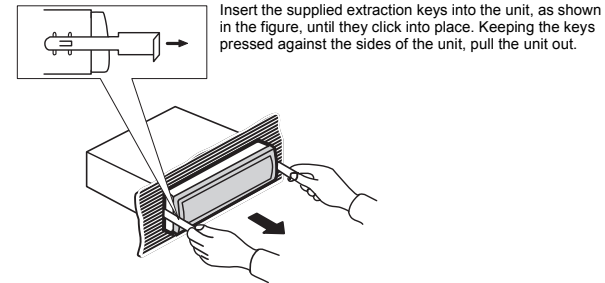

DIN Rear-mount

Installation using the screw holes on the side of the unit

1. Remove the frame.

To remove the frame, extend top and bottom of the frame outwards in order to unlock it. (When reattaching the frame, point the side with a groove downwards and attach it.)

- It becomes easy to remove the frame if the front panel is released.

Installation

2. Fastening the unit to the factory radio mounting bracket.

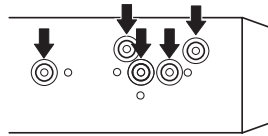

Select a position where the screw holes of the bracket and the screw holes of the head unit become aligned (are fitted) and tighten the screws at 2 places on each side. Use either truss screws (5 x 8 mm) or flush surface screws (5 x 9 mm), depending on the shape of the screw holes in the bracket.

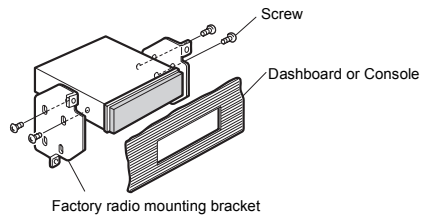

Fixing the front panel

If you do not operate the Removing and Attaching the Front Panel Function, use the supplied fixing screws and fix the front panel to this unit.

1. Fix the front panel to the unit using fixing screws.

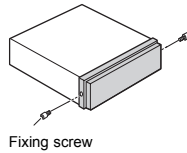

Before You Start



If you want to dispose this product, do not mix it with general household waste. There is a separate collection system for used electronic products in accordance with legislation that requires proper treatment, recovery and recycling.

Private households in the 25 member states of the EU, in Switzerland and Norway may return their used electronic products free of charge to designated collection facilities or to a retailer (if you purchase a similar new one).

For countries not mentioned above, please contact your local authorities for the correct method of disposal.

By doing so you will ensure that your disposed product undergoes the necessary treatment, recovery and recycling and thus prevent potential negative effects on the environment and human health.

About this unit

The tuner frequencies on this unit are allocated for use in Western Europe, Asia, the Middle East, Africa and Oceania. Use in other areas may result in poor reception. The RDS (radio data system) function operates only in areas with FM stations broadcasting RDS signals.

⚠ CAUTION

- Do not allow this unit to come into contact with liquids. Electrical shock could result. Also, this unit damage, smoke, and overheat could result from contact with liquids.
- "CLASS 1 LASER PRODUCT"
- This product contains a laser diode of higher class than 1. To ensure continued safety, do not remove any covers or attempt to gain access to the inside of the product. Refer all servicing to qualified personnel.
- The Pioneer CarStereo-Pass is for use only in Germany.
- Keep this manual handy as a reference for operating procedures and precautions.
- Always keep the volume low enough so that you can hear sounds from outside the vehicle.
- Protect this unit from moisture.
- If the battery is disconnected or discharged, the preset memory will be erased and must be reprogrammed.

Before You Start

About this manual

This unit features a number of sophisticated functions ensuring superior reception and operation. All the functions have been designed for the easiest possible use, but many are not self-explanatory. This operation manual will help you benefit fully from this unit's potential and to maximize your listening enjoyment.

We recommend that you familiarize yourself with the functions and their operation by reading through the manual before you begin using this unit. It is especially important that you read and observe **WARNINGS** and **CAUTIONS** in this manual.

In case of trouble

Should this product fail to operate properly, contact your dealer or nearest authorized Pioneer Service Station.

Features

CD playback

Music CD/CD-R/CD-RW playback is possible.

MP3 file playback

You can play back MP3 files recorded on CD-ROM/CD-R/CD-RW (ISO9660 Level 1/ Level 2 standard recordings).

- Supply of this product only conveys a license for private, non-commercial use and does not convey a license nor imply any right to use this product in any commercial (i.e. revenue-generating) real time broadcasting (terrestrial, satellite, cable and/or any other media), broadcasting/streaming via internet, intranets and/or other networks or in other electronic content distribution systems, such as pay-audio or audio-on-demand applications. An independent license for such use is required. For details, please visit <http://www.mp3licensing.com>.

WMA file playback

You can play back WMA files recorded on CD-ROM/CD-R/CD-RW (ISO9660 Level 1/ Level 2 standard recordings).

WAV file playback

You can play back WAV files recorded on CD-ROM/CD-R/CD-RW (ISO9660 Level 1/ Level 2 standard recordings).

About WMA



The Windows Media™ logo printed on the box indicates that this unit can play back WMA data.

WMA is short for Windows Media™ Audio and refers to an audio compression technology that is developed by Microsoft Corporation. WMA data can be encoded by using Windows Media Player version 7 or later.

Windows Media and the Windows logo are trademarks or registered trademarks of Microsoft Corporation in the United States and/or other countries.

Notes

- This unit may not operate correctly depending on the application used to encode WMA files.
- Depending on the version of Windows Media Player used to encode WMA files, album names and other text information may not be correctly displayed.
- There may be a slight delay when starting playback of WMA files encoded with image data.

Visit our website

Visit us at the following site:

www.pioneer.co.uk

- Register your product. We will keep the details of your purchase on file to help you refer to this information in the event of an insurance claim such as loss or theft.
- We offer the latest information about Pioneer Corporation on our website.

ENGLISH

Before You Start

Protecting your unit from theft

The front panel can be detached from the head unit and stored in the provided protective case to prevent theft.

Important

- Never use force or grip the display and the buttons too tightly when removing or attaching.
- Avoid subjecting the front panel to excessive shocks.
- Keep the front panel out of direct sunlight and high temperatures.

Removing the front panel

1. Press DETACH to release the front panel.

Press **DETACH** and the right side of the panel is released from the head unit.

2. Grab the front panel and remove.

Grab the right side of the front panel and pull away to the left. The front panel will be detached from the head unit.

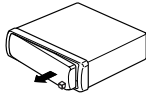

3. Put the front panel into provided protective case for safe keeping.

Attaching the front panel

1. Place the front panel flat against the head unit.

2. Press the front panel into the face of the head unit until it is firmly seated.

What's What

Head unit

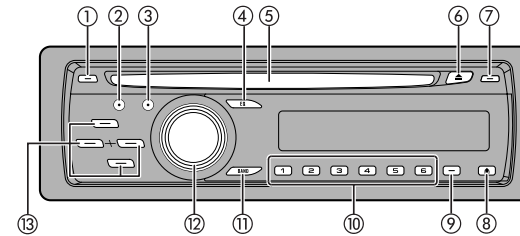

- | | |
|---|---|
| <p>① TA button
Press to turn TA function on or off. Press and hold to turn AF function on or off.</p> <p>② AUDIO button
Press to select various sound quality controls.</p> <p>③ FUNCTION button
Press to select functions.</p> <p>④ EQ button
Press to select various equalizer curves.</p> <p>⑤ Disc loading slot
Insert a disc to play.</p> <p>⑥ EJECT button
Press to eject a CD from your built-in CD player.</p> <p>⑦ DISPLAY button
Press to select different displays.</p> <p>⑧ DETACH button
Press to remove the front panel from the head unit.</p> | <p>⑨ SW button
Press to select the subwoofer setting menu. Press and hold to select the bass boost setting menu.</p> <p>⑩ 1-6 buttons
Press for preset tuning and disc number search when using a multi-CD player.</p> <p>⑪ BAND button
Press to select among three FM bands and MW/LW bands and to cancel the control mode of functions.</p> <p>⑫ SOURCE button, VOLUME
This unit is turned on by selecting a source. Press to cycle through all the available sources.
Rotate it to increase or decrease the volume.</p> <p>⑬ ▲/▼/▶/◀ buttons
Press to perform manual seek tuning, fast forward, reverse and track search controls. Also used for controlling functions.</p> |
|---|---|

What's What

Optional remote control

The remote control CD-R310 is sold separately.

Operation is the same as when using the buttons on the head unit. See the explanation of the head unit about the operation of each button with the exception of **ATT**, which is explained below.

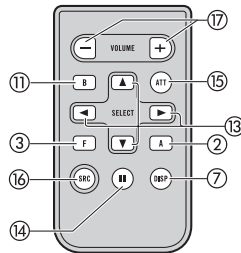

14 PAUSE button

Press to turn pause on or off.

15 ATT button

Press to quickly lower the volume level, by about 90%. Press once more to return to the original volume level.

16 SOURCE button

Press to cycle through all the available sources. Press and hold to turn the source off.

17 VOLUME button

Press to increase or decrease the volume.

Power ON/OFF

Turning the unit on

- Press **SOURCE** to turn the unit on.

When you select a source, the unit is turned on.

Selecting a source

You can select a source you want to listen to. To switch to the built-in CD player, load a disc in the unit (refer to page 14).

- Press **SOURCE** to select a source.

Press **SOURCE** repeatedly to switch between the following sources:

Tuner – Television – Built-in CD player – Multi-CD player – External unit 1 – External unit 2 – AUX1 – AUX2

Notes

- In the following cases, the sound source will not change:
 - When there is no unit corresponding to the selected source connected to this unit.
 - When there is no disc in the unit.
 - When there is no magazine in the multi-CD player.
 - When the AUX (auxiliary input) is set to off (refer to page 29).
- External unit refers to a Pioneer product (such as one available in the future) that, although incompatible as a source, enables control of basic functions by this unit. Two external units can be controlled by this unit. When two external units are connected, the allocation of them to external unit 1 or external unit 2 is automatically set by this unit.
- When this unit's blue/white lead is connected to the vehicle's auto-antenna relay control terminal, the vehicle's antenna extends when this unit's source is turned on. To retract the antenna, turn the source off.

Turning the unit off

- Press **SOURCE** and hold until the unit turns off.

ENGLISH

Tuner

Listening to the radio

These are the basic steps necessary to operate the radio. More advanced tuner operation is explained starting on this page.

This unit's AF (alternative frequencies search) function can be turned on and off. AF should be off for normal tuning operation (refer to page 12).

- ① **Band indicator**
Shows which band the radio is tuned to, MW/LW or FM.
- ② **Preset number indicator**
Shows which preset has been selected.
- ③ **Frequency indicator**
Shows the frequency to which the tuner is tuned.
- ④ **Stereo (◐) indicator**
Shows when the selected frequency is being broadcast in stereo.

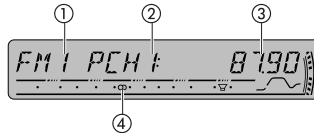

1. Press SOURCE to select the tuner.

Press **SOURCE** until you see **TUNER** displayed.

2. Use VOLUME to adjust the sound level.

Rotate it to increase or decrease the volume.

3. Press BAND to select a band.

Press **BAND** until the desired band is displayed, **FM1**, **FM2** for FM or **MW/LW**.

4. To perform manual tuning, briefly press ◀ or ▶.

The frequencies move up or down step by step.

5. To perform seek tuning, press and hold ◀ or ▶ for about one second and release.

The tuner will scan the frequencies until a broadcast strong enough for good reception is found.

- You can cancel seek tuning by briefly pressing ◀ or ▶.
- If you press and hold ◀ or ▶ you can skip stations. Seek tuning starts as soon as you release the button.

Note

- When the frequency selected is being broadcast in stereo the stereo (◐) indicator will light.

Introduction of advanced tuner operation

- ① **Function display**
Shows the function status.
- ② **LOC indicator**
Shows when local seek tuning is on.

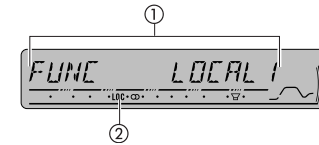

• Press FUNCTION to display the function names.

Press **FUNCTION** repeatedly to switch between the following functions:

BSM (best stations memory) – **REG** (regional) – **LOCAL** (local seek tuning) – **TA** (traffic announcement standby) – **AF** (alternative frequencies search)

- To return to the frequency display, press **BAND**.
- If MW/LW band is selected, you can only select **BSM** or **LOCAL**.

Note

- If you do not operate the function within about 30 seconds, the display is automatically returned to the frequency display.

Storing and recalling broadcast frequencies

If you press any of the preset tuning buttons **1–6** you can easily store up to six broadcast frequencies for later recall with the touch of a button.

• When you find a frequency that you want to store in memory, press one of preset tuning buttons 1–6 and hold until the preset number stops flashing.

The number you have pressed will flash in the preset number indicator and then remain lit. The selected radio station frequency has been stored in memory.

The next time you press the same preset tuning button the radio station frequency is recalled from memory.

Notes

- Up to 18 FM stations, six for each of the three FM bands, and six MW/LW stations can be stored in memory.
- You can also use ▲ and ▼ to recall radio station frequencies assigned to preset tuning buttons **1–6**.

Tuner

Tuning in strong signals

Local seek tuning lets you tune in only those radio stations with sufficiently strong signals for good reception.

1. Press FUNCTION to select LOCAL.

Press **FUNCTION** until **LOCAL** appears in the display.

2. Press ▲ to turn local seek tuning on.

Local seek sensitivity (e.g., **LOCAL 2**) appears in the display.

3. Press ◀ or ▶ to set the sensitivity.

There are four levels of sensitivity for FM and two levels for MW/LW:

FM: **LOCAL 1 – LOCAL 2 – LOCAL 3 – LOCAL 4**

MW/LW: **LOCAL 1 – LOCAL 2**

The **LOCAL 4** setting allows reception of only the strongest stations, while lower settings let you receive progressively weaker stations.

4. When you want to return to normal seek tuning, press ▼ to turn local seek tuning off.

LOCAL:OFF appears in the display.

Storing the strongest broadcast frequencies

BSM (best stations memory) lets you automatically store the six strongest broadcast frequencies under preset tuning buttons 1–6. Once stored you can tune in to those frequencies with the touch of button.

1. Press FUNCTION to select BSM.

Press **FUNCTION** until **BSM** appears in the display.

2. Press ▲ to turn BSM on.

BSM begins to flash. While **BSM** is flashing the six strongest broadcast frequencies will be stored under preset tuning buttons 1–6 in the order of their signal strength. When finished, **BSM** stops flashing.

- To cancel the storage process, press ▼.

Note

- Storing broadcast frequencies with BSM may replace broadcast frequencies you have saved using buttons 1–6.

RDS

Introduction of RDS operation

RDS (radio data system) is a system for providing information along with FM broadcasts. This inaudible information provides such features as program service name, program type, traffic announcement standby and automatic tuning, and is intended to aid radio listeners in finding and tuning in to a desired station.

① **Program service name**

Shows the name of broadcast program.

② **TP indicator**

Shows when a TP station is tuned in.

③ **TA :ON indicator**

Shows when TA (traffic announcement standby) function is on.

④ **AF indicator**

Shows when AF (alternative frequencies search) function is on.

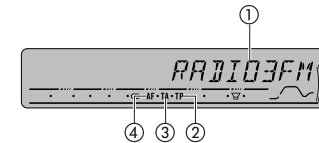

• **Press FUNCTION to display the function names.**

Press **FUNCTION** repeatedly to switch between the following functions:

BSM (best stations memory) – **REG** (regional) – **LOCAL** (local seek tuning) – **TA** (traffic announcement standby) – **AF** (alternative frequencies search)

- To return to the frequency display, press **BAND**.
- If MW/LW band is selected, you can only select **BSM** or **LOCAL**.

Notes

- If you do not operate the function within about 30 seconds, the display is automatically returned to the frequency display.
- RDS service may not be provided by all stations.
- RDS functions such as AF and TA are only active when your radio is tuned to an RDS station.

RDS

Switching the RDS display

When you tune in an RDS station its program service name is displayed. Switch the display to find out the frequency.

- Press **DISPLAY**.

Press **DISPLAY** repeatedly to switch between the following settings:

Program service name – PTY information – Frequency

- The frequency of the current station appears on the display for eight seconds.

Selecting alternative frequencies

If you are listening to a broadcast and the reception becomes weak or there are other problems, the unit will automatically search for a different station in the same network which is broadcasting a stronger signal.

- The default setting for AF is on.

1. Press **FUNCTION** to select **AF**.

Press **FUNCTION** until **AF** appears in the display.

2. Press **▲** to turn **AF** on.

Press **▲** and **AF :ON** is displayed.

3. Press **▼** to turn **AF** off.

Press **▼** and **AF :OFF** is displayed.

Notes

- Only RDS stations are tuned in during seek tuning or BSM when AF is on.
- When you recall a preset station, the tuner may update the preset station with a new frequency from the station's AF list. (This is only available when using presets on the **FM1** or **FM2** bands.) No preset number appears on the display if the RDS data for the station received differs from that for the originally stored station.
- Sound may be temporarily interrupted by another program during an AF frequency search.
- AF can be turned on or off independently for each FM band.

Using PI Seek

If the unit fails to find a suitable alternative frequency, or if you are listening to a broadcast and the reception becomes weak, the unit will automatically search for a different station with the same programming. During the search, **PI SEEK** is displayed and the output is muted. The muting is discontinued after completion of the PI Seek, whether or not a different station is found.

Using Auto PI Seek for preset stations

When preset stations cannot be recalled, as when travelling long distances, the unit can be set to perform PI Seek during preset recall.

- The default setting for Auto PI Seek is off. See "Switching Auto PI Seek" on page 29.

Limiting stations to regional programming

When AF is used to automatically retune frequencies, the regional function limits the selection to stations broadcasting regional programs.

1. Press **FUNCTION** to select **REG**.

Press **FUNCTION** until **REG** appears in the display.

2. Press **▲** to turn the regional function on.

Press **▲** and **REG :ON** is displayed.

3. Press **▼** to turn the regional function off.

Press **▼** and **REG :OFF** is displayed.

Notes

- Regional programming and regional networks are organized differently depending on the country (i.e., they may change according to the hour, state or broadcast area).
- The preset number may disappear on the display if the tuner tunes in a regional station which differs from the originally set station.
- The regional function can be turned on or off independently for each FM band.

Receiving traffic announcements

TA (traffic announcement standby) lets you receive traffic announcements automatically, no matter what source you are listening to. TA can be activated for both a TP station (a station that broadcasts traffic information) or an enhanced other network's TP station (a station carrying information which cross-references TP stations).

1. Tune in a TP or enhanced other network's TP station.

When you are tuned into a TP or enhanced other network's TP station the **TP** indicator will light.

2. Press **TA** to turn traffic announcement standby on.

Press **TA** and **TA :ON** appears in the display. The tuner will stand-by for traffic announcements.

- To turn traffic announcements standby off, press **TA** again.

RDS

3. Use **VOLUME** to adjust the TA volume when a traffic announcement begins.

Rotate it to increase or decrease the volume.

The newly set volume is stored in memory and recalled for subsequent traffic announcements.

4. Press **TA** while a traffic announcement is being received to cancel the announcement.

The tuner returns to the original source but remains in the standby mode until **TA** is pressed again.

- You can also cancel the announcement by pressing **SOURCE**, **BAND**, **▲**, **▼**, **◀** or **▶** while a traffic announcement is being received.

Notes

- You can also turn the TA function on or off in the menu that appears with the pressing of **FUNCTION**.
- The system switches back to the original source following traffic announcement reception.
- Only TP and enhanced other network's TP stations are tuned in during seek tuning or BSM when TA is on.

Receiving PTY alarm broadcasts

PTY alarm is a special PTY code for announcements regarding emergencies such as natural disasters. When the tuner receives the radio alarm code, **ALARM** appears on the display and the volume adjusts to the TA volume. When the station stops broadcasting the emergency announcement, the system returns to the previous source.

- An emergency announcement can be canceled by pressing **TA**.
- You can also cancel an emergency announcement by pressing **SOURCE**, **BAND**, **▲**, **▼**, **◀** or **▶**.

PTY list

Specific	Type of program
NEWS	News
AFFAIRS	Current affairs
INFO	General information and advice
SPORT	Sports
WEATHER	Weather reports/meteorological information
FINANCE	Stock market reports, commerce, trading, etc.
POP MUS	Popular music
ROCK MUS	Contemporary modern music
EASY MUS	Easy listening music
OTH MUS	Non-categorized music
JAZZ	Jazz
COUNTRY	Country music
NAT MUS	National music
OLDIES	Oldies, golden oldies
FOLK MUS	Folk music
L. CLASS	Light classical music
CLASSIC	Classical music
EDUCATE	Educational programs
DRAMA	Radio plays and serials
CULTURE	National or regional culture
SCIENCE	Nature, science and technology
VARIED	Light entertainment
CHILDREN	Children's
SOCIAL	Social affairs
RELIGION	Religious affairs or services
PHONE IN	Phone in
TOURING	Travel programs; not for traffic announcements
LEISURE	Hobbies and recreational activities
DOCUMENT	Documentaries

Built-in CD Player

Playing a CD

These are the basic steps necessary to play a CD with your built-in CD player. More advanced CD operation is explained starting on this page.

- ① **Track number indicator**
Shows the track currently playing.
- ② **Play time indicator**
Shows the elapsed playing time of the current track.

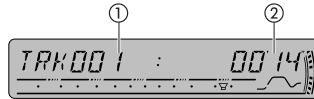

1. Insert a CD into the CD loading slot.

Playback will automatically start.

- You can eject a CD by pressing **EJECT**.
- To avoid a malfunction, make sure that no metal object comes into contact with the terminals when the front panel is open.

2. Use **VOLUME** to adjust the sound level.

Rotate it to increase or decrease the volume.

3. To perform fast forward or reverse, press and hold ◀ or ▶.

- If you select **ROUGH**, pressing and holding ◀ or ▶ enables you to search every 10 tracks in the current disc. (Refer to "Selecting the search method" on page 15.)

4. To skip back or forward to another track, press ◀ or ▶.

Pressing ▶ skips to the start of the next track. Pressing ◀ once skips to the start of the current track. Pressing again will skip to the previous track.

Notes

- The built-in CD player plays one standard, 12-cm or 8-cm CD at a time. Do not use an adapter when playing 8-cm CDs.
- Do not insert anything other than a CD into the CD loading slot.
- If you cannot insert a disc completely or if after you insert a disc the disc does not play, check that the label side of the disc is up. Press **EJECT** to eject the disc, and check the disc for damage before inserting it again.
- If an error message such as **ERROR-11** is displayed, refer to "Understanding built-in CD player error messages" on page 31.
- When a CD TEXT disc is inserted, the disc and track titles begin to scroll to the left automatically.

Introduction of advanced built-in CD player operation

- ① **Function display**
Shows the function status.
- ② **RPT indicator**
Shows when repeat play is turned on.

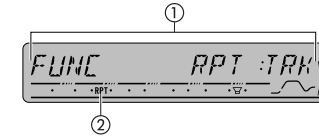

• Press **FUNCTION** to display the function names.

Press **FUNCTION** repeatedly to switch between the following functions:

RPT (repeat play) – **RDM** (random play) – **SCAN** (scan play) – **PAUSE** (pause) – **COMP** (compression and BMX) – **FF/REV** (search method)

- To return to the playback display, press **BAND**.

Note

- If you do not operate the function within about 30 seconds, the display is automatically returned to the playback display.

Repeating play

Repeat play lets you hear the same track or disc over again.

1. Press **FUNCTION** to select **RPT**.

Press **FUNCTION** until **RPT** appears in the display.

2. Press ◀ or ▶ to select the repeat range.

This switches you to the selected setting.

- **DSC** – Repeat the current disc
- **TRK** – Repeat just the current track

Note

- If you perform track search or fast forward/reverse during **TRK**, the repeat play range changes to **DSC**.

Built-in CD Player

Playing tracks in random order

Random play lets you play back tracks on the CD in a random order.

1. **Press FUNCTION to select RDM.**
Press **FUNCTION** until **RDM** appears in the display.
2. **Press ▲ to turn random play on.**
RDM :ON appears in the display. Tracks will play in a random order.
3. **Press ▼ to turn random play off.**
RDM :OFF appears in the display. Tracks will continue to play in order.

Scanning tracks of a CD

Scan play lets you hear the first 10 seconds of each track on the CD.

1. **Press FUNCTION to select SCAN.**
Press **FUNCTION** until **SCAN** appears in the display.
2. **Press ▲ to turn scan play on.**
SCAN :ON appears in the display. The first 10 seconds of each track is played.
3. **When you find the desired track press ▼ to turn scan play off.**
SCAN :OFF appears in the display. The track will continue to play.
 - If the display has automatically returned to the playback display, select **SCAN** again by pressing **FUNCTION**.

Note

- After scanning of a CD is finished, normal playback of the tracks will begin again.

Pausing CD playback

Pause lets you temporarily stop playback of the CD.

1. **Press FUNCTION to select PAUSE.**
Press **FUNCTION** until **PAUSE** appears in the display.
2. **Press ▲ to turn pause on.**
PAUSE:ON appears in the display. Play of the current track pauses.
3. **Press ▼ to turn pause off.**
PAUSE:OFF appears in the display. Play will resume at the same point that you turned pause on.

Using compression and BMX

Using the COMP (compression) and BMX functions let you adjust the sound playback quality of this player. Each of the functions has a two-step adjustment. The COMP function balances the output of louder and softer sounds at higher volumes. BMX controls sound reverberations to give playback a fuller sound. Listen to each of the effects as you select through them and use the one that best enhances the playback of the track or CD that you are listening to.

1. **Press FUNCTION to select COMP.**
Press **FUNCTION** until **COMP** appears in the display.
2. **Press ▲ or ▼ to select your favorite setting.**
Press **▲** or **▼** repeatedly to switch between the following settings:
COMP OFF – COMP 1 – COMP 2 – COMP OFF – BMX 1 – BMX 2

Selecting the search method

You can switch the search method between fast forward/reverse and searching every 10 tracks.

1. **Press FUNCTION to select FF/REV.**
Press **FUNCTION** until **FF/REV** appears in the display.
 - If the search method **ROUGH** has been previously selected, **ROUGH** will be displayed.
2. **Press ◀ or ▶ to select the search method.**
Press **◀** or **▶** until the desired search method appears in the display.
 - **FF/REV** – Fast forward and reverse
 - **ROUGH** – Searching every 10 tracks

Searching every 10 tracks in the current disc

If a disc contains over 10 tracks, you can search every 10 tracks. When a disc contains many tracks, you can roughly search for the track you want to play.

1. **Select the search method ROUGH.**
Refer to "Selecting the search method" on this page.
2. **Press and hold ◀ or ▶ to search every 10 tracks on a disc.**
 - If a disc contains less than 10 tracks, pressing and holding **▶** recalls the last track of the disc. Also, if the remaining number of tracks after searching every 10 tracks is less than 10, pressing and holding **▶** recalls the last track of the disc.

Built-in CD Player

- If a disc contains less than 10 tracks, pressing and holding ◀ recalls the first track of the disc. Also, if the remaining number of tracks after searching every 10 tracks is less than 10, pressing and holding ◀ recalls the first track of the disc.

Using disc title functions

You can input CD titles and display the title. The next time you insert a CD for which you have entered a title, the title of that CD will be displayed.

Entering disc titles

Use the disc title input feature to store up to 48 CD titles in the unit. Each title can be up to 8 characters long.

1. **Play the CD that you want to enter a title for.**
2. **Press FUNCTION and hold until TITLE IN appears in the display.**
 - When playing a CD TEXT disc, you cannot switch to **TITLE IN**. The disc title will have already been recorded on a CD TEXT disc.
3. **Press ▲ or ▼ to select a letter of the alphabet.**

Each press of ▲ will display a letter of the alphabet in **A B C ... X Y Z**, numbers and symbols in **1 2 3 ... > []** order. Each press of ▼ will display a letter in the reverse order, such as **Z Y X ... C B A** order.



4. **Press ► to move the cursor to the next character position.**

When the letter you want is displayed, press ► to move the cursor to the next position and then select the next letter. Press ◀ to move backwards in the display.
5. **Move the cursor to the last position by pressing ► after entering the title.**

When you press ► one more time, the entered title is stored in memory.
6. **Press BAND to return to the playback display.**

Notes

- Titles remain in memory, even after the disc has been removed from the unit, and are recalled when the disc is reinserted.
- After data for 48 discs has been stored in memory, data for a new disc will overwrite the oldest one.
- If you connect a multi-CD player, you can input disc titles for up to 100 discs.

Displaying disc titles

You can display the text information of any disc that has had a disc title entered.

- **Press DISPLAY.**

Press **DISPLAY** repeatedly to switch between the following settings:
Play time – **DISC TITLE** (disc title)

When you select **DISC TITLE**, the title of the currently playing disc is shown in the display.

 - If no title has been entered for the currently playing disc, **NO DISC TITLE** is displayed.

Using CD TEXT functions

Some discs have certain information encoded on the disc during manufacture. These discs may contain such information as the CD title, track title, artist's name and playback time and are called CD TEXT discs. Only these specially encoded CD TEXT discs support the functions listed below.

Displaying text information on CD TEXT discs

- **Press DISPLAY.**

Press **DISPLAY** repeatedly to switch between the following settings:
Play time – **DISC TITLE** (disc title) – **DISC ARTIST** (disc artist name) – **TRACK TITLE** (track title) – **TRACK ARTIST** (track artist name)

 - If specific information has not been recorded on a CD TEXT disc, **NO XXXX** will be displayed (e.g., **NO TRACK TITLE**).

Scrolling text information in the display

This unit can display the first 16 letters only of **DISC TITLE**, **DISC ARTIST**, **TRACK TITLE** and **TRACK ARTIST**. When the recorded information is longer than 16 letters, you can scroll the text to the left so that the rest of the title can be seen.

- **Press DISPLAY and hold until the title begins to scroll to the left.**

The rest of the title will appear in the display.

MP3/WMA/WAV Player

Playing MP3/WMA/WAV

These are the basic steps necessary to play an MP3/WMA/WAV with your built-in CD player. More advanced MP3/WMA/WAV operation is explained starting on this page.

- ① **Track number indicator**
Shows the track (file) currently playing.
- ② **Folder number indicator**
Shows the number of folder currently playing.
- ③ **Play time indicator**
Shows the elapsed playing time of the current track (file).
- ④ **WMA indicator**
Shows when a WMA file is playing.
- ⑤ **MP3 indicator**
Shows when an MP3 file is playing.

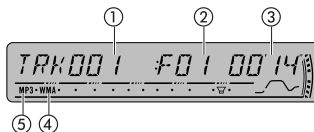

1. Insert a CD-ROM into the CD loading slot.

Playback will automatically start.

- You can eject a CD-ROM by pressing **EJECT**.
- To avoid a malfunction, make sure that no metal object comes into contact with the terminals when the front panel is open.

2. Use **VOLUME** to adjust the sound level.

Rotate it to increase or decrease the volume.

3. Press **▲** or **▼** to select a folder.

- You cannot select a folder that does not have an MP3/WMA/WAV file recorded in it.
- To return to folder 01 (ROOT), press and hold **BAND**. However, if folder 01 (ROOT) contains no files, playback commences with folder 02.

4. To perform fast forward or reverse, press and hold **◀** or **▶**.

- This is fast forward and reverse operation only for the file being played.
- If you select **ROUGH**, pressing and holding **◀** or **▶** enables you to search every 10 tracks in the current folder. (Refer to "Selecting the search method" on page 19.)

5. To skip back or forward to another track, press **◀** or **▶**.

Pressing **▶** skips to the start of the next track. Pressing **◀** once skips to the start of the current track. Pressing again will skip to the previous track.

Notes

- When playing discs with MP3/WMA/WAV files and audio data (CD-DA) such as CD-EXTRA and MIXED-MODE CDs, both types can be played only by switching mode between MP3/WMA/WAV and CD-DA with **BAND**.
- If you have switched between playback of MP3/WMA/WAV files and audio data (CD-DA), playback starts at the first track on the disc.
- The built-in CD player can play back an MP3/WMA/WAV file recorded on CD-ROM. (Refer to page 32 for files that can be played back.)
- Do not insert anything other than a CD into the CD loading slot.
- There is sometimes a delay between starting up CD playback and the sound being issued. When being read, **FORMAT READ** is displayed.
- If you cannot insert a disc completely or if after you insert a disc the disc does not play, check that the label side of the disc is up. Press **EJECT** to eject the disc, and check the disc for damage before inserting it again.
- Playback is carried out in order of file number. Folders are skipped if they contain no files. (If folder 01 (ROOT) contains no files, playback commences with folder 02.)
- When playing back files recorded as VBR (variable bit rate) files, the play time will not be correctly displayed if fast forward or reverse operations are used.
- If the inserted disc contains no files that can be played back, **NO AUDIO** is displayed.
- If the inserted disc contains WMA files that are protected by digital rights management (DRM), **SKIPPED** is displayed while the protected file is skipped.
- If all the files on the inserted disc are secured by DRM, **PROTECT** is displayed.
- There is no sound on fast forward or reverse.
- If an error message such as **ERROR-11** is displayed, refer to "Understanding built-in CD player error messages" on page 31.
- When an MP3/WMA/WAV disc is inserted, folder name and file name begin to scroll to the left automatically.

Introduction of advanced built-in CD player (MP3/WMA/WAV) operation

- ① **Function display**
Shows the function status.
- ② **RPT indicator**
Shows when repeat range is selected to current track (file).

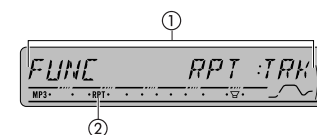

● Press **FUNCTION** to display the function names.

Press **FUNCTION** repeatedly to switch between the following functions:

RPT (repeat play) – **RDM** (random play) – **SCAN** (scan play) – **PAUSE** (pause) – **COMP** (compression and BMX) – **FF/REV** (search method)

- To return to the playback display, press **BAND**.

Note

- If you do not operate the function within about 30 seconds, the display is automatically returned to the playback display.

MP3/WMA/WAV Player

Repeating play

For MP3/WMA/WAV playback, there are three repeat play ranges: **FLD** (folder repeat), **TRK** (one-track repeat) and **DSC** (repeat all tracks).

1. Press FUNCTION to select RPT.

Press **FUNCTION** until **RPT** appears in the display.

2. Press ◀ or ▶ to select the repeat range.

Press **◀** or **▶** until the desired repeat range appears in the display.

- **FLD** – Repeat the current folder
- **TRK** – Repeat just the current track
- **DSC** – Repeat all tracks

Notes

- If you select another folder during repeat play, the repeat play range changes to **DSC**.
- If you perform track search or fast forward/reverse during **TRK**, the repeat play range changes to **FLD**.
- When **FLD** is selected, it is not possible to play back a subfolder of that folder.
- When you select **FLD** for the repeating range and return to the playback display, **FRPT** is displayed.

Playing tracks in random order

Random play lets you play back tracks in a random order within the repeat range, **FLD** and **DSC**.

1. Select the repeat range.

Refer to "Repeating play" on this page.

2. Press FUNCTION to select RDM.

Press **FUNCTION** until **RDM** appears in the display.

3. Press ▲ to turn random play on.

RDM :ON appears in the display. Tracks will play in a random order within the previously selected **FLD** or **DSC** ranges.

4. Press ▼ to turn random play off.

RDM :OFF appears in the display. Tracks will continue to play in order.

Note

- If you turn random play on during **FLD** and then return to the playback display, **FRDM** appears in the display.

Scanning folders and tracks

While you are using **FLD**, the beginning of each track in the selected folder plays for about 10 seconds. When you are using **DSC**, the beginning of the first track of each folder is played for about 10 seconds.

1. Select the repeat range.

Refer to "Repeating play" on this page.

2. Press FUNCTION to select SCAN.

Press **FUNCTION** until **SCAN** appears in the display.

3. Press ▲ to turn scan play on.

SCAN :ON appears in the display. The first 10 seconds of each track of the current folder (or the first track of each folder) is played.

4. When you find the desired track (or folder) press ▼ to turn scan play off.

SCAN :OFF appears in the display. The track (or disc) will continue to play.

- If the display has automatically returned to the playback display, select **SCAN** again by pressing **FUNCTION**.

Notes

- After track or folder scanning is finished, normal playback of the tracks will begin again.
- If you turn scan play on during **FLD** and then return to the playback display, **FSCN** appears in the display.

Pausing MP3/WMA/WAV playback

Pause lets you temporarily stop playback of the MP3/WMA/WAV.

1. Press FUNCTION to select PAUSE.

Press **FUNCTION** until **PAUSE** appears in the display.

2. Press ▲ to turn pause on.

PAUSE:ON appears in the display. Play of the current track pauses.

3. Press ▼ to turn pause off.

PAUSE:OFF appears in the display. Play will resume at the same point that you turned pause on.

MP3/WMA/WAV Player

Using compression and BMX

Using the COMP (compression) and BMX functions let you adjust the sound playback quality of this player. Each of the functions has a two-step adjustment. The COMP function balances the output of louder and softer sounds at higher volumes. BMX controls sound reverberations to give playback a fuller sound. Listen to each of the effects as you select through them and use the one that best enhances the playback of the track or CD that you are listening to.

1. Press FUNCTION to select COMP.

Press **FUNCTION** until **COMP** appears in the display.

2. Press ▲ or ▼ to select your favorite setting.

Press ▲ or ▼ repeatedly to switch between the following settings:

COMP OFF – COMP 1 – COMP 2 – COMP OFF – BMX 1 – BMX 2

Selecting the search method

You can switch the search method between fast forward/reverse and searching every 10 tracks.

1. Press FUNCTION to select FF/REV.

Press **FUNCTION** until **FF/REV** appears in the display.

- If the search method **ROUGH** has been previously selected, **ROUGH** will be displayed.

2. Press ◀ or ▶ to select the search method.

Press ◀ or ▶ until the desired search method appears in the display.

- **FF/REV** – Fast forward and reverse
- **ROUGH** – Searching every 10 tracks

Searching every 10 tracks in the current folder

If the current folder contains over 10 tracks, you can search every 10 tracks. When one folder contains a lot of tracks, you can roughly search for the track you want to play.

1. Select the search method **ROUGH**.

Refer to "Selecting the search method" on this page.

2. Press and hold ◀ or ▶ to search every 10 tracks in the current folder.

- If the current folder contains less than 10 tracks, pressing and holding ▶ recalls the last track of the folder. Also, if the remaining number of tracks after searching every 10 tracks is less than 10, pressing and holding ▶ recalls the last track of the folder.
- If the current folder contains less than 10 tracks, pressing and holding ◀ recalls the first track of the folder. Also, if the remaining number of tracks after searching every 10 tracks is less than 10, pressing and holding ◀ recalls the first track of the folder.

Displaying text information on MP3/WMA/WAV disc

Text information recorded on an MP3/WMA/WAV disc can be displayed.

When playing back an MP3/WMA disc

• Press **DISPLAY**.

Press **DISPLAY** repeatedly to switch between the following settings:

Play time – **FOLDER** (folder name) – **FILE** (file name) – **TRACK TITLE** (track title) – **ARTIST** (artist name) – **ALBUM** (album title) – **COMMENT** (comment) – Bit rate

- When playing back MP3 files recorded as VBR (variable bit rate) files, the bit rate value is not displayed even after switching to bit rate.
- When playing back WMA files recorded as VBR (variable bit rate) files, the average bit rate value is displayed.
- If specific information has not been recorded on an MP3/WMA disc, **NO XXXX** will be displayed (e.g., **NO NAME**).
- Depending on the version of iTunes® used to write MP3 files onto a disc, comment information may not be correctly displayed.
- iTunes® is a trademark of Apple Computer, Inc., registered in the U.S. and other countries.
- Depending on the version of Windows Media Player used to encode WMA files, album names and other text information may not be correctly displayed.

MP3/WMA/WAV Player

When playing back a WAV disc

- Press **DISPLAY**.
Press **DISPLAY** repeatedly to switch between the following settings:
Play time – **FOLDER** (folder name) – **FILE** (file name) – Sampling frequency
- If specific information has not been recorded on a WAV disc, **NO XXXX** will be displayed (e.g., **NO NAME**).
- You can only play back WAV files in the frequencies 16 kHz, 22.05 kHz, 24 kHz, 32 kHz, 44.1 kHz and 48 kHz (LPCM), or 22.05 kHz and 44.1 kHz (MS ADPCM).
The sampling frequency shown in the display may be rounded.

Scrolling text information in the display

This unit can display the first 16 letters only of **FOLDER**, **FILE**, **TRACK TITLE**, **ARTIST**, **ALBUM** and **COMMENT**. When the recorded information is longer than 16 letters, you can scroll the text to the left so that the rest of the text information can be seen.

- Press **DISPLAY** and hold until the text information begins to scroll to the left.
The rest of the text information will appear in the display.

Note

- Unlike MP3 and WMA file format, WAV files display only **FOLDER** and **FILE**.

Multi-CD Player

Playing a CD

You can use this unit to control a multi-CD player, which is sold separately.

These are the basic steps necessary to play a CD with your multi-CD player. More advanced CD operation is explained starting on page 21.

- ① **Track number indicator**
Shows the track currently playing.
- ② **Disc number indicator**
Shows the disc currently playing.
- ③ **Play time indicator**
Shows the elapsed playing time of the current track.

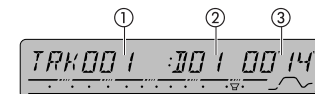

1. Press **SOURCE** to select the multi-CD player.
Press **SOURCE** until you see **MULTI CD** displayed.
2. Use **VOLUME** to adjust the sound level.
Rotate it to increase or decrease the volume.
3. Select a disc you want to listen to with the 1–6 buttons.
For discs 1 to 6, press the corresponding button number.
For discs 7 to 12, press and hold the corresponding numbers, such as **1** for disc 7, until the disc number appears in the display.
 - You can also sequentially select a disc by pressing **▲/▼**.
4. To perform fast forward or reverse, press and hold **◀** or **▶**.
5. To skip back or forward to another track, press **◀** or **▶**.
Pressing **▶** skips to the start of the next track. Pressing **◀** once skips to the start of the current track. Pressing again will skip to the previous track.

Notes

- When the multi-CD player performs the preparatory operations, **READY** is displayed.
- If an error message such as **ERROR-11** is displayed, refer to the multi-CD player owner's manual.
- If there are no discs in the multi-CD player magazine, **NO DISC** is displayed.
- When you select a CD TEXT disc on a CD TEXT compatible multi-CD player, the disc and track titles begin to scroll to the left automatically.

Multi-CD Player

50-disc multi-CD player

Only those functions described in this manual are supported by 50-disc multi-CD players.

Introduction of advanced multi-CD player operation

① **Function display**

Shows the function status.

② **RPT indicator**

Shows when repeat range is selected to current track.

● **Press FUNCTION to display the function names.**

Press **FUNCTION** repeatedly to switch between the following functions:

RPT (repeat play) – **RDM** (random play) – **SCAN** (scan play) – **ITS-P** (ITS play) – **PAUSE** (pause) – **COMP** (compression and DBE)

- To return to the playback display, press **BAND**.

Note

- If you do not operate the function within about 30 seconds, the display is automatically returned to the playback display.

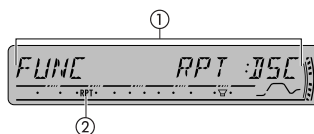

Repeating play

There are three repeat play ranges for the multi-CD player: **MCD** (multi-CD player repeat), **TRK** (one-track repeat) and **DSC** (disc repeat).

1. Press FUNCTION to select RPT.

Press **FUNCTION** until **RPT** appears in the display.

2. Press ◀ or ▶ to select the repeat range.

Press **◀** or **▶** until the desired repeat range appears in the display.

- **MCD** – Repeat all discs in the multi-CD player magazine
- **TRK** – Repeat just the current track
- **DSC** – Repeat the current disc

Notes

- If you select other discs during repeat play, the repeat play range changes to **MCD**.
- If you perform track search or fast forward/reverse during **TRK**, the repeat play range changes to **DSC**.
- When you select **DSC** for the repeating range and return to the playback display, **DRPT** is displayed.

Playing tracks in random order

Random play lets you play back tracks in random order within the repeat range, **MCD** and **DSC**.

1. Select the repeat range.

Refer to "Repeating play" on this page.

2. Press FUNCTION to select RDM.

Press **FUNCTION** until **RDM** appears in the display.

3. Press ▲ to turn random play on.

RDM :ON appears in the display. Tracks will play in a random order within the previously selected **MCD** or **DSC** ranges.

4. Press ▼ to turn random play off.

RDM :OFF appears in the display. Tracks will continue to play in order.

Note

- If you turn random play on during **DSC** and then return to the playback display, **DRDM** appears in the display.

Scanning CDs and tracks

While you are using **DSC**, the beginning of each track on the selected disc plays for about 10 seconds. When you are using **MCD**, the beginning of the first track of each disc is played for about 10 seconds.

1. Select the repeat range.

Refer to "Repeating play" on this page.

2. Press FUNCTION to select SCAN.

Press **FUNCTION** until **SCAN** appears in the display.

3. Press ▲ to turn scan play on.

SCAN :ON appears in the display. The first 10 seconds of each track of the current disc (or the first track of each disc) is played.

Multi-CD Player

4. When you find the desired track (or disc) press ▼ to turn scan play off.

SCAN :OFF appears in the display. The track (or disc) will continue to play.

- If the display has automatically returned to the playback display, select **SCAN** again by pressing **FUNCTION**.

Notes

- After track or disc scanning is finished, normal playback of the tracks will begin again.
- If you turn scan play on during **DSC** and then return to the playback display, **DSCN** appears in the display.

Pausing CD playback

Pause lets you temporarily stop playback of the CD.

1. Press **FUNCTION** to select **PAUSE**.

Press **FUNCTION** until **PAUSE** appears in the display.

2. Press ▲ to turn pause on.

PAUSE:ON appears in the display. Play of the current track pauses.

3. Press ▼ to turn pause off.

PAUSE:OFF appears in the display. Play will resume at the same point that you turned pause on.

Using ITS playlists

ITS (instant track selection) lets you make a playlist of favorite tracks from those in the multi-CD player magazine. After you have added your favorite tracks to the playlist you can turn on ITS play and play just those selections.

Creating a playlist with ITS programming

You can use ITS to enter and play back up to 99 tracks per disc from up to 100 discs (with the disc titles). (With multi-CD players sold before the CDX-P1250 and CDX-P650, up to 24 tracks can be stored in the playlist.)

1. Play a CD that you want to program.

Press ▲ or ▼ to select the CD.

2. Press **FUNCTION** and hold until **TITLE IN** appears in the display, then press **FUNCTION** to select ITS.

After **TITLE IN** is displayed, press **FUNCTION** repeatedly, the following functions appear in the display:

TITLE IN (disc title input) – **ITS** (ITS programming)

3. Select the desired track by pressing ◀ or ▶.

4. Press ▲ to store the currently playing track in the playlist.

ITS IN is displayed briefly and the currently playing selection is added to your playlist. The display then shows **ITS** again.

5. Press **BAND** to return to the playback display.

Note

- After data for 100 discs has been stored in memory, data for a new disc will overwrite the oldest one.

Playback from your ITS playlist

ITS play lets you listen to the tracks that you have entered into your ITS playlist. When you turn on ITS play, tracks from your ITS playlist in the multi-CD player will begin to play.

1. Select the repeat range.

Refer to "Repeating play" on page 21.

2. Press **FUNCTION** to select **ITS-P**.

Press **FUNCTION** until **ITS-P** appears in the display.

3. Press ▲ to turn ITS play on.

ITS-P:ON appears in the display. Playback begins of those tracks from your playlist within the previously selected **MCD** or **DSC** ranges.

- If no tracks in the current range are programmed for ITS play, then **EMPTY** is displayed.

4. Press ▼ to turn ITS play off.

ITS-P:OFF appears in the display. Playback will continue in normal order from the currently playing track and CD.

Erasing a track from your ITS playlist

You can delete a track from your ITS playlist if ITS play is on.

If ITS play is already on, skip to step 2. If ITS play is not already on, press **FUNCTION**.

1. Play the CD with the track you want to delete from your ITS playlist, and turn ITS play on.

Refer to "Playback from your ITS playlist" on this page.

2. Press **FUNCTION** and hold until **TITLE IN** appears in the display, then press **FUNCTION** to select ITS.

After **TITLE IN** is displayed, press **FUNCTION** until **ITS** appears in the display.

Multi-CD Player

3. Select the desired track by pressing ◀ or ▶.
4. Press ▼ to erase the track from your ITS playlist.
The currently playing selection is erased from your ITS playlist and playback of the next track from your ITS playlist begins.
 - If there are no tracks from your playlist in the current range, **EMPTY** is displayed and normal play resumes.
5. Press **BAND** to return to the playback display.

Erasing a CD from your ITS playlist

You can delete all tracks of a CD from your ITS playlist if ITS play is off.

1. **Play the CD that you want to delete.**
Press ▲ or ▼ to select the CD.
2. **Press FUNCTION and hold until TITLE IN appears in the display, then press FUNCTION to select ITS.**
After **TITLE IN** is displayed, press **FUNCTION** until **ITS** appears in the display.
3. **Press ▼ to erase all tracks on the currently playing CD from your ITS playlist.**
All tracks on the currently playing CD are erased from your playlist and **ITS CLR** is displayed.
4. Press **BAND** to return to the playback display.

Using disc title functions

You can input CD titles and display the titles. Then you can easily search for and play a desired disc.

Entering disc titles

Use the disc title input feature to store up to 100 CD titles (with ITS playlist) into the multi-CD player. Each title can be up to 8 characters long.

1. **Play the CD that you want to enter a title for.**
Press ▲ or ▼ to select the CD.
2. **Press FUNCTION and hold until TITLE IN appears in the display.**
After **TITLE IN** is displayed, press **FUNCTION** repeatedly, the following functions appear in the display:

TITLE IN (disc title input) – **ITS** (ITS programming)

 - When playing a CD TEXT disc on a CD TEXT compatible multi-CD player, you cannot switch to **TITLE IN**. The disc title has already been recorded on a CD TEXT disc.

3. Press ▲ or ▼ to select a letter of the alphabet.

Each press of ▲ will display a letter of the alphabet in **A B C ... X Y Z**, numbers and symbols in **1 2 3 ... > []** order. Each press of ▼ will display a letter in the reverse order, such as **Z Y X ... C B A** order.



4. **Press ▶ to move the cursor to the next character position.**
When the letter you want is displayed, press ▶ to move the cursor to the next position and then select the next letter. Press ◀ to move backwards in the display.
5. **Move the cursor to the last position by pressing ▶ after entering the title.**
When you press ▶ one more time, the entered title is stored in memory.
6. Press **BAND** to return to the playback display.

Notes

- Titles remain in memory, even after the disc has been removed from the magazine, and are recalled when the disc is reinserted.
- After data for 100 discs has been stored in memory, data for a new disc will overwrite the oldest one.

Displaying disc titles

You can display the text information of any disc that has had a disc title entered.

- **Press DISPLAY.**
Press **DISPLAY** repeatedly to switch between the following settings:
Play time – **DISC TITLE** (disc title)
When you select **DISC TITLE**, the title of the currently playing disc is shown in the display.
 - If no title has been entered for the currently playing disc, **NO DISC TITLE** is displayed.

Using CD TEXT functions

You can use these functions only with a CD TEXT compatible multi-CD player.

Some discs have certain information encoded on the disc during manufacture. These discs may contain such information as the CD title, track title, artist's name and playback time and are called CD TEXT discs. Only these specially encoded CD TEXT discs support the functions listed below.

Multi-CD Player

Displaying text information on CD TEXT discs

- Press **DISPLAY**.
Press **DISPLAY** repeatedly to switch between the following settings:
Play time – **DISC TITLE** (disc title) – **DISC ARTIST** (disc artist name) – **TRACK TITLE** (track title) – **TRACK ARTIST** (track artist name)
- If specific information has not been recorded on a CD TEXT disc, **NO XXXX** will be displayed (e.g., **NO TRACK TITLE**).

Scrolling text information in the display

This unit can display the first 16 letters only of **DISC TITLE**, **DISC ARTIST**, **TRACK TITLE** and **TRACK ARTIST**. When the recorded information is longer than 16 letters, you can scroll the text to the left so that the rest of the title can be seen.

- Press **DISPLAY** and hold until the title begins to scroll to the left.
The rest of the title will appear in the display.

Using compression and bass emphasis

You can use these functions only with a multi-CD player that supports them.

Using **COMP** (compression) and **DBE** (dynamic bass emphasis) functions lets you adjust the sound playback quality of the multi-CD player. Each of the functions has a two-step adjustment. The **COMP** function balances the output of louder and softer sounds at higher volumes. **DBE** boosts bass levels to give playback a fuller sound. Listen to each of the effects as you select them and use the one that best enhances the playback of the track or CD that you are listening to.

1. Press **FUNCTION** to select **COMP**.

Press **FUNCTION** until **COMP** appears in the display.

- If the multi-CD player does not support **COMP/DBE**, **NO COMP** is displayed when you attempt to select it.

2. Press **▲** or **▼** to select your favorite setting.

Press **▲** or **▼** repeatedly to switch between the following settings:

COMP OFF – **COMP 1** – **COMP 2** – **COMP OFF** – **DBE 1** – **DBE 2**

Audio Adjustments

Introduction of audio adjustments

- ① **Audio display**
Shows the audio adjustment status.
- ② **CUSTOM indicator**
Shows when custom equalizer curve is currently selected.
- ③ **SW indicator**
Shows when the subwoofer output is turned on.
- ④ **Bass booster indicator**
Shows when the bass boost is in effect.
- ⑤ **Loudness indicator**
Appears in the display when loudness is turned on.
- ⑥ **FIE indicator**
Shows when the front image enhancer is turned on.

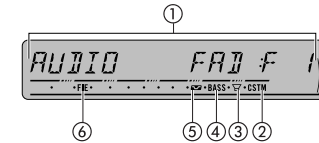

• Press **AUDIO** to display the audio function names.

Press **AUDIO** repeatedly to switch between the following audio functions:

FAD (balance adjustment) – **EQ** (equalizer curve adjustment) – **LOUD** (loudness) – **SUB W** (subwoofer on/off setting) – **80: 0** (subwoofer setting) – **HPF** (high pass filter) – **BASS** (bass boost) – **FIE** (front image enhancer) – **SLA** (source level adjustment)

- When the subwoofer controller setting is **P/O :FUL**, you cannot switch to **SUB W**. (Refer to page 29.)
- You can select the **80: 0** only when subwoofer output is turned on in **SUB W**.
- When selecting the FM tuner as the source, you cannot switch to **SLA**.
- To return to the display of each source, press **BAND**.

Note

- If you do not operate the audio function within about 30 seconds, the display is automatically returned to the source display.

Audio Adjustments

Using balance adjustment

You can select a fader/balance setting that provides an ideal listening environment in all occupied seats.

1. Press AUDIO to select FAD.

Press **AUDIO** until **FAD** appears in the display.

- If the balance setting has been previously adjusted, **BAL** will be displayed.

2. Press ▲ or ▼ to adjust front/rear speaker balance.

Each press of **▲** or **▼** moves the front/rear speaker balance towards the front or the rear.

FAD : F15 – FAD : R15 is displayed as the front/rear speaker balance moves from front to rear.

- **FAD : 0** is the proper setting when only two speakers are used.
- When the rear output setting is **R-SP : S/W**, you cannot adjust front/rear speaker balance. Refer to "Setting the rear output and subwoofer controller" on page 29.

3. Press ◀ or ▶ to adjust left/right speaker balance.

When you press **◀** or **▶**, **BAL : 0** is displayed. Each press of **◀** or **▶** moves the left/right speaker balance towards the left or the right.

BAL : L15 – BAL : R15 is displayed as the left/right speaker balance moves from left to right.

Using the equalizer

The equalizer lets you adjust the equalization to match car interior acoustic characteristics as desired.

Recalling equalizer curves

There are six stored equalizer curves which you can easily recall at any time. Here is a list of the equalizer curves:

Display	Equalizer curve
SUPER BASS	Super bass
POWERFUL	Powerful
NATURAL	Natural
VOCAL	Vocal
CUSTOM	Custom
EQ FLAT	Flat

- **CUSTOM** is an adjusted equalizer curve that you create. If you make adjustments to an equalizer curve, the equalizer curve setting will be memorized in **CUSTOM**.
- When **EQ FLAT** is selected no supplement or correction is made to the sound. This is useful to check the effect of the equalizer curves by switching alternatively between **EQ FLAT** and a set equalizer curve.
- **Press EQ to select the equalizer.**

Press **EQ** repeatedly to switch between the following equalizers:

SUPER BASS – POWERFUL – NATURAL – VOCAL – CUSTOM – EQ FLAT

Adjusting equalizer curves

You can adjust the currently selected equalizer curve setting as desired. Adjusted equalizer curve settings are memorized in **CUSTOM**.

1. Press AUDIO to select EQ.

Press **AUDIO** until **EQ** appears in the display.

2. Press ◀ or ▶ to select the equalizer band to adjust.

Each press of **◀** or **▶** selects equalizer bands in the following order:

EQ-L (low) – **EQ-M** (mid) – **EQ-H** (high)

3. Press ▲ or ▼ to adjust the level of the equalizer band.

Each press of **▲** or **▼** increases or decreases the level of the equalization band.

+6 – -6 is displayed as the level is increased or decreased.

- You can then select another band and adjust the level.

Note

- If you make adjustments, **CUSTOM** curve is updated.

Audio Adjustments

Fine-adjusting equalizer curve

You can adjust the center frequency and the Q factor (curve characteristics) of each currently selected curve band (**EQ-L/EQ-M/EQ-H**).

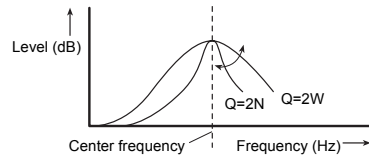

1. Press **AUDIO** and hold until frequency and the Q factor (e.g., **F- 80:Q1W**) appears in the display.
2. Press **AUDIO** to select the band for adjustment from among low, mid and high.
Press **AUDIO** repeatedly to switch between the following functions:
Low – Mid – High
3. Press **◀** or **▶** to select the desired frequency.
Press **◀** or **▶** until the desired frequency appears in the display.
Low: **40 – 80 – 100 – 160** (Hz)
Mid: **200 – 500 – 1k – 2k** (Hz)
High: **3k – 8k – 10k – 12k** (Hz)
4. Press **▲** or **▼** to select the desired Q factor.
Press **▲** or **▼** until the desired Q factor appears in the display.
2N – 1N – 1W – 2W

Note

- If you make adjustments, **CUSTOM** curve is updated.

Adjusting loudness

Loudness compensates for deficiencies in the low- and high-sound ranges at low volume.

1. Press **AUDIO** to select **LOUD**.
Press **AUDIO** until **LOUD** appears in the display.
2. Press **▲** to turn loudness on.
Loudness level (e.g., **LOUD :MID**) appears in the display.
3. Press **◀** or **▶** to select a desired level.
Each press of **◀** or **▶** selects level in the following order:
LOW (low) – **MID** (mid) – **HI** (high)
4. Press **▼** to turn loudness off.
LOUD :OFF appears in the display.

Using subwoofer output

This unit is equipped with a subwoofer output which can be turned on or off.

1. Press **SW** to select **SUB W**.
SUB W appears in the display.
 - You can also select the subwoofer setting menu by pressing **AUDIO** on the unit.
 - When the subwoofer controller setting is **P/O :FUL**, you cannot select **SUB W**.
2. Press **▲** to turn subwoofer output on.
SUB W:NOR appears in the display. Subwoofer output is now on.
 - If the subwoofer output phase has been set to the reverse, **SUB W:REV** will be displayed.
 - To turn subwoofer output off, press **▼**.
3. Press **◀** or **▶** to select the phase of subwoofer output.
Press **◀** to select reverse phase and **REV** appears in the display. Press **▶** to select normal phase and **NOR** appears in the display.

Audio Adjustments

Adjusting subwoofer settings

When the subwoofer output is on, you can adjust the cut-off frequency and the output level of the subwoofer.

1. Press SW to select 80: 0.

Press **SW** until **80: 0** appears in the display.

- You can also select the subwoofer setting menu by pressing **AUDIO** on the unit.
- When the subwoofer output is on, you can select **80: 0**.
- If the subwoofer setting has been previously adjusted, the frequency of that previously selected will be displayed instead of **80**.

2. Press ◀ or ▶ to select cut-off frequency.

Each press of ◀ or ▶ selects cut-off frequencies in the following order:

50 – 63 – 80 – 100 – 125 (Hz)

Only frequencies lower than those in the selected range are outputted from the subwoofer.

3. Press ▲ or ▼ to adjust the output level of the subwoofer.

Each press of ▲ or ▼ increases or decreases the level of the subwoofer. **+6 – –24** is displayed as the level is increased or decreased.

Using the high pass filter

When you do not want low sounds from the subwoofer output frequency range to play from the front or rear speakers, turn on the HPF (high pass filter). Only frequencies higher than those in the selected range are outputted from the front or rear speakers.

1. Press AUDIO to select HPF.

Press **AUDIO** until **HPF** appears in the display.

2. Press ▲ to turn high pass filter on.

HPF : 80 appears in the display. High pass filter is now on.

- If the high pass filter has been previously adjusted, the frequency of that previously selected will be displayed instead of **HPF : 80**.
- To turn high pass filter off, press ▼.

3. Press ◀ or ▶ to select cut-off frequency.

Each press of ◀ or ▶ selects cut-off frequencies in the following order:

50 – 63 – 80 – 100 – 125 (Hz)

Only frequencies higher than those in the selected range are outputted from the front or rear speakers.

Boosting the bass

Bass boost function boosts the bass level of sound lower than 100 Hz. The more the bass level is increased, the more the bass sound is emphasized and the entire sound becomes powerful. When using this function with the subwoofer, the sound under the cut-off frequency is boosted.

1. Press AUDIO to select BASS.

Press **AUDIO** until **BASS** appears in the display.

- You can also select the bass boost setting by pressing and holding **SW**.

2. Press ▲ or ▼ to select a desired level.

0 – 6 is displayed as the level is increased or decreased.

Front image enhancer (F.I.E.)

The F.I.E. (Front Image Enhancer) function is a simple method of enhancing front imaging by cutting mid- and high-range frequency output from the rear speakers, limiting their output to low-range frequencies. You can select the frequency you want to cut.

Precaution

When the F.I.E. function is deactivated, the rear speakers output sound of all frequencies, not just bass sounds. Reduce the volume before disengaging F.I.E. to prevent a sudden increase in volume.

1. Press AUDIO to select FIE.

Press **AUDIO** until **FIE** appears in the display.

- When the rear output setting is **R-SP :S/W**, you cannot select F.I.E. function.

2. Press ▲ to turn F.I.E. on.

- To turn F.I.E. off, press ▼.

3. Press ◀ or ▶ to select a desired frequency.

Each press of ◀ or ▶ selects frequency in the following order:

100 – 160 – 250 (Hz)

Notes

- After turning the F.I.E. function on, use the balance adjustment (refer to page 25) and adjust front and rear speaker volume levels until they are balanced.
- Turn the F.I.E. function off when using a 2-speaker system.

Audio Adjustments

Adjusting source levels

SLA (source level adjustment) lets you adjust the volume level of each source to prevent radical changes in volume when switching between sources.

- Settings are based on the FM tuner volume level, which remains unchanged.

1. Compare the FM tuner volume level with the level of the source you wish to adjust.
2. Press **AUDIO** to select SLA.
Press **AUDIO** until **SLA** appears in the display.
3. Press **▲** or **▼** to adjust the source volume.

Each press of **▲** or **▼** increases or decreases the source volume.

SLA : +4 – SLA : -4 is displayed as the source volume is increased or decreased.

Notes

- Since the FM tuner volume is the control, it is not possible to apply source level adjustments to the FM tuner.
- The MW/LW tuner volume level can also be adjusted with source level adjustments.
- The built-in CD player and the multi-CD player are set to the same source level adjustment volume automatically.
- External unit 1 and external unit 2 are set to the same source level adjustment volume automatically.

Initial Settings

Adjusting initial settings

Using the initial settings, you can customize various system settings to achieve optimal performance from this unit.

- ① **Function display**
Shows the function status.

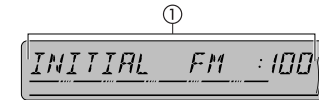

1. Press **SOURCE** and hold until the unit turns off.
2. Press **SOURCE** and hold again until function name appears in the display.
3. Press **FUNCTION** to select one of the initial settings.

Press **FUNCTION** repeatedly to switch between the following settings:

FM (FM tuning step) – **A-PI** (auto PI seek) – **AUX1** (auxiliary input1) – **AUX2** (auxiliary input2) – **R-SP** (rear output and subwoofer controller) – **SAVE** (power save)

- To cancel initial settings, press **BAND**.
- You can also cancel initial settings by holding down **SOURCE** until the unit turns off.

Setting the FM tuning step

Normally the FM tuning step employed by seek tuning is 50 kHz. When AF or TA is on, the tuning step automatically changes to 100 kHz. It may be preferable to set the tuning step to 50 kHz when AF is on.

1. Press **FUNCTION** to select **FM**.

Press **FUNCTION** repeatedly until **FM** appears in the display.

2. Press **◀** or **▶** to select the FM tuning step.

Pressing **◀** or **▶** will switch the FM tuning step between 50 kHz and 100 kHz while AF or TA is on. The selected FM tuning step will appear in the display.

Note

- The tuning step remains at 50 kHz during manual tuning.

Initial Settings

Switching Auto PI Seek

The unit can automatically search for a different station with the same programming, even during preset recall.

1. Press FUNCTION to select A-PI.

Press **FUNCTION** repeatedly until **A-PI** appears in the display.

2. Press ▲ or ▼ to turn A-PI on or off.

Pressing **▲** or **▼** will turn **A-PI** on or off and that status will be displayed (e.g., **A-PI :ON**).

Switching the auxiliary setting

Auxiliary equipments connected to this unit can be activated individually. Set each AUX source to ON when using. About connecting or using auxiliary equipments, refer to "Using the AUX source" on page 30.

1. Press FUNCTION to select AUX1/AUX2.

Press **FUNCTION** repeatedly until **AUX1/AUX2** appears in the display.

2. Press ▲ or ▼ to turn AUX1/AUX2 on or off.

Pressing **▲** or **▼** will turn **AUX** on or off and that status will be displayed (e.g., **AUX1 :ON**).

Setting the rear output and subwoofer controller

This unit's rear output (rear speaker leads output and RCA rear output) can be used for full-range speaker (**R-SP :FUL**) or subwoofer (**R-SP :S/W**) connection. If you switch the rear output setting to **R-SP :S/W**, you can connect a rear speaker lead directly to a subwoofer without using an auxiliary amp.

Initially, the unit is set for rear full-range speaker connection (**R-SP :FUL**). When rear output is connected to full range speakers (when **R-SP :FUL** is selected), you can connect other full range speakers (**P/O :FUL**) or a subwoofer (**P/O :S/W**) to the RCA rear output.

1. Press FUNCTION to select R-SP.

Press **FUNCTION** repeatedly until **R-SP** appears in the display.

2. Press ▲ or ▼ to switch the rear output setting.

Pressing **▲** or **▼** will switch between **R-SP :FUL** (full-range speaker) and **R-SP :S/W** (subwoofer) and that status will be displayed.

- When no subwoofer is connected to the rear output, select **R-SP :FUL**.
- When a subwoofer is connected to the rear output, set for subwoofer **R-SP :S/W**.
- When the rear output setting is **R-SP :S/W**, you cannot operate the following procedure.

3. Press ◀ or ▶ to switch the subwoofer output or rear output.

Pressing **◀** or **▶** will switch between **P/O :S/W** and **P/O :FUL** and that status will be displayed.

Notes

- Even if you change this setting, there is no output unless you turn the subwoofer output on (refer to "Using subwoofer output" on page 26).
- If you change this setting, subwoofer output in the audio menu return to the factory settings.

Saving the battery consumption

Even when this unit is switched off, the microcomputer inside still uses a small amount of power in order to enable a quick restart. Switching on the Power Save mode will prevent the microcomputer from running unnecessarily, thereby saving the battery in your vehicle.

- With Power Save mode on, you cannot insert or eject a disc when power to the unit is off. Press **SOURCE** to switch the unit on, then try again.

Important

If the battery in your vehicle is disconnected the Power Save mode is canceled. Turn on Power Save again once the battery has been reconnected. If the ignition switch in your vehicle doesn't have an ACC (accessory) position, it is possible depending on the connection method that when Power Save is off, the unit will draw power from the battery.

- 1. Press FUNCTION to select SAVE.**
- 2. Press ▲ or ▼ to turn power save on or off.**

ENGLISH

Other Functions

Using the AUX source

This unit can control up to two auxiliary equipments such as VCR or portable devices (sold separately). When connected, auxiliary equipments are automatically read in as AUX sources and assigned to **AUX1** or **AUX2**. The relationship between **AUX1** and **AUX2** sources is explained below.

About AUX1 and AUX2

You have two methods to connect auxiliary equipments to this unit.

AUX1 source:

When connecting auxiliary equipment using a stereo mini plug cable

- **Insert the stereo mini plug into the input jack on this unit.**

For more details, refer to the installation manual.

The allocation of this auxiliary equipment is automatically set to **AUX1**.

AUX2 source:

When connecting auxiliary equipment using an IP-BUS-RCA Interconnector (sold separately)

- **Use an IP-BUS-RCA Interconnector such as the CD-RB20/CD-RB10 (sold separately) to connect this unit to auxiliary equipment featuring RCA output.**

For more details, refer to the IP-BUS-RCA Interconnector owner's manual.

The allocation of this auxiliary equipment is automatically set to **AUX2**.

- You can only make this type of connection if the auxiliary equipment has RCA outputs.

Selecting AUX as the source

- **Press SOURCE to select AUX (AUX1 or AUX2) as the source.**

Press **SOURCE** until **AUX** appears in the display.

- If the auxiliary setting is not turned on, **AUX** cannot be selected. For more details, see "Switching the auxiliary setting" on page 29.

Setting the AUX title

The title displayed for each **AUX1** or **AUX2** source can be changed.

- 1. After you have selected AUX as the source, press FUNCTION and hold until TITLE IN appears in the display.**

- 2. Press ▲ or ▼ to select a letter of the alphabet.**

Each press of ▲ will display a letter of the alphabet in **A B C ... X Y Z**, numbers and symbols in **1 2 3 ... > []** order. Each press of ▼ will display a letter in the reverse order, such as **Z Y X ... C B A** order.



- 3. Press ► to move the cursor to the next character position.**

When the letter you want is displayed, press ► to move the cursor to the next position and then select the next letter. Press ◀ to move backwards in the display.

- 4. Move the cursor to the last position by pressing ► after entering the title.**

When you press ► one more time, the entered title is stored in memory.

- 5. Press BAND to return to the playback display.**

Additional Information

Understanding built-in CD player error messages

When you contact your dealer or your nearest Pioneer Service Center, be sure to record the error message.

Message	Cause	Action
ERROR-11, 12, 17, 30	Dirty disc	Clean disc.
ERROR-11, 12, 17, 30	Scratched disc	Replace disc.
ERROR-15	The inserted disc does not contain any data	Replace disc.
ERROR-10, 11, 12, 15, 17, 30, A0	Electrical or mechanical	Turn the ignition ON and OFF, or switch to a different source, then back to the CD player.
ERROR-22, 23	The CD format cannot be played back	Replace disc.
NO AUDIO	The inserted disc does not contain any files that can be played back	Replace disc.
SKIPPED	The inserted disc contains WMA files that are protected by DRM	Replace disc.
PROTECT	All the files on the inserted disc are secured by DRM	Replace disc.

Sound muting

Sound from this unit is muted automatically in the following cases:

- When a call is made or received using a cellular telephone connected to this unit.
- When the voice guidance is output from a Pioneer navigation unit connected to this unit.

The sound is turned off, **MUTE** is displayed and no audio adjustments, except volume control, are possible. Operation returns to normal when the phone connection or the voice guidance is ended.

CD player and care

- Use only CDs that have either of the two Compact Disc Digital Audio marks as shown below.



- Use only normal, round CDs. If you insert irregular, non-round, shaped CDs they may jam in the CD player or not play properly.



- Check all CDs for cracks, scratches or warping before playing. CDs that have cracks, scratches or are warped may not play properly. Do not use such discs.
- Avoid touching the recorded (non-printed) surface when handling the disc.
- Store discs in their cases when not in use.
- Keep discs out of direct sunlight and do not expose the discs to high temperatures.
- Do not attach labels, write on or apply chemicals to the surface of the discs.
- To clean a CD, wipe the disc with a soft cloth outward from the center.



- If the heater is used in cold weather, moisture may form on components inside the CD player. Condensation may cause the CD player to malfunction. If you think that condensation is a problem turn off the CD player for an hour or so to allow it to dry out and wipe any damp discs with a soft cloth to remove the moisture.
- Road shocks may interrupt CD playback.

CD-R/CD-RW discs

- When CD-R/CD-RW discs are used, playback is possible only for discs which have been finalized.
- It may not be possible to play back CD-R/CD-RW discs recorded on a music CD recorder or a personal computer because of disc characteristics, scratches or dirt on the disc, or dirt, condensation, etc., on the lens of this unit.
- Playback of discs recorded on a personal computer may not be possible, depending on the application settings and the environment. Please record with the correct format. (For details, contact the manufacturer of the application.)
- Playback of CD-R/CD-RW discs may become impossible in case of direct exposure to sunlight, high temperatures, or the storage conditions in the vehicle.
- Titles and other text information recorded on a CD-R/CD-RW disc may not be displayed by this unit (in the case of audio data (CD-DA)).

Additional Information

- If you insert a CD-RW disc into this unit, time to playback will be longer than when you insert a conventional CD or CD-R disc.
- Read the precautions with CD-R/CD-RW discs before using them.

MP3, WMA and WAV files

- MP3 is short for MPEG Audio Layer 3 and refers to an audio compression technology standard.
- WMA is short for Windows Media™ Audio and refers to an audio compression technology that is developed by Microsoft Corporation. WMA data can be encoded by using Windows Media Player version 7 or later.
- WAV is short for waveform. It is a standard audio file format for Windows®.
- This unit may not operate correctly depending on the application used to encode WMA files.
- Depending on the version of Windows Media Player used to encode WMA files, album names and other text information may not be correctly displayed.
- There may be a slight delay when starting playback of WMA files encoded with image data.
- This unit allows playback of MP3/WMA/WAV files on CD-ROM, CD-R and CD-RW discs. Disc recordings compatible with level 1 and level 2 of ISO9660 and with the Romeo and Joliet file system can be played back.
- It is possible to play back multi-session compatible recorded discs.
- MP3/WMA/WAV files are not compatible with packet write data transfer.
- The maximum number of characters which can be displayed for a file name, including the extension (.mp3, .wma or .wav), is 64, from the first character.
- The maximum number of characters which can be displayed for a folder name is 64.
- In case of files recorded according to the Romeo file system, only the first 64 characters can be displayed.
- When playing discs with MP3/WMA/WAV files and audio data (CD-DA) such as CD-EXTRA and MIXED-MODE CDs, both types can be played only by switching mode between MP3/WMA/WAV and CD-DA.
- The folder selection sequence for playback and other operations becomes the writing sequence used by the writing software. For this reason, the expected sequence at the time of playback may not coincide with the actual playback sequence. However, there also is some writing software which permits setting of the playback order.

- Some audio CDs contain tracks that merge into one another without a pause. When these discs are converted to MP3/WMA/WAV files and burned to a CD-R/CD-RW/CD-ROM, the files will be played back on this player with a short pause between each one, regardless of the length of the pause between tracks on the original audio CD.

Important

- When naming an MP3/WMA/WAV file, add the corresponding filename extension (.mp3, .wma or .wav).
- This unit plays back files with the filename extension (.mp3, .wma or .wav) as an MP3/WMA/WAV file. To prevent noise and malfunctions, do not use these extensions for files other than MP3/WMA/WAV files.

MP3 additional information

- Files are compatible with the ID3 Tag Ver. 1.0, 1.1, 2.2, 2.3 and 2.4 formats for display of album (disc title), track (track title), artist (track artist) and comments. Ver. 2.x of ID3 Tag is given priority when both Ver. 1.x and Ver. 2.x exist.
- The emphasis function is valid only when MP3 files of 32 kHz, 44.1 kHz and 48 kHz frequencies are played back. (16 kHz, 22.05 kHz, 24 kHz, 32 kHz, 44.1 kHz, 48 kHz sampling frequencies can be played back.)
- There is no m3u playlist compatibility.
- There is no compatibility with the MP3i (MP3 interactive) or mp3 PRO formats.
- The sound quality of MP3 files generally becomes better with an increased bit rate. This unit can play recordings with bit rates from 8 kbps to 320 kbps, but in order to be able to enjoy sound of a certain quality, we recommend using only discs recorded with a bit rate of at least 128 kbps.

WMA additional information

- This unit plays back WMA files encoded by Windows Media Player version 7, 7.1, 8, 9 and 10.
- You can only play back WMA files in the frequencies 32 kHz, 44.1 kHz and 48 kHz.
- The sound quality of WMA files generally becomes better with an increased bit rate. This unit can play recordings with bit rates from 48 kbps to 320 kbps (CBR) or from 48 kbps to 384 kbps (VBR), but in order to be able to enjoy sound of a certain quality, we recommend using discs recorded with a higher bit rate.
- This unit doesn't support the following formats.
 - Windows Media Audio 9 Professional (5.1 ch)
 - Windows Media Audio 9 Lossless
 - Windows Media Audio 9 Voice

Additional Information

WAV additional information

- This unit plays back WAV files encoded in Linear PCM (LPCM) format or MS ADPCM format.
- You can only play back WAV files in the frequencies 16 kHz, 22.05 kHz, 24 kHz, 32 kHz, 44.1 kHz and 48 kHz (LPCM), or 22.05 kHz and 44.1 kHz (MS ADPCM). The sampling frequency shown in the display may be rounded.
- The sound quality of WAV files generally becomes better with a larger number of quantization bits. This unit can play recordings with 8 and 16 (LPCM) or 4 (MS ADPCM) quantization bits, but in order to be able to enjoy sound of a certain quality, we recommend using discs recorded with the larger number of quantization bits.

About folders and MP3/WMA/WAV files

- An outline of a CD-ROM with MP3/WMA/WAV files on it is shown below. Subfolders are shown as folders in the folder currently selected.

Notes

- This unit assigns folder numbers. The user cannot assign folder numbers.
- It is not possible to check folders that do not include MP3/WMA/WAV files. (These folders will be skipped without displaying the folder number.)
- MP3/WMA/WAV files in up to 8 tiers of folders can be played back. However, there is a delay in the start of playback on discs with numerous tiers. For this reason we recommend creating discs with no more than 2 tiers.
- It is possible to play back up to 99 folders on one disc.

- ① First level
- ② Second level
- ③ Third level

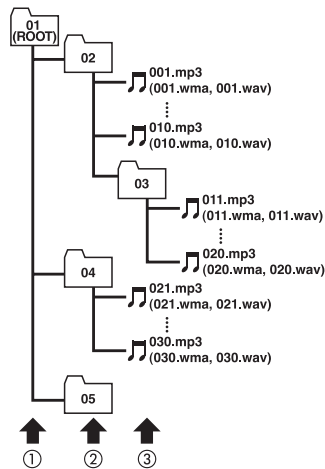

Terms

Bit rate

This expresses data volume per second, or bps (bits per second) units. The higher the rate, the more information is available to reproduce the sound. Using the same encoding method (such as MP3), the higher the rate, the better the sound.

ID3 tag

This is a method of embedding track-related information in an MP3 file. This embedded information can include the track title, the artist's name, the album title, the music genre, the year of production, comments and other data. The contents can be freely edited using software with ID3 Tag editing functions. Although the tags are restricted as to the number of characters, the information can be viewed when the track is played back.

ISO9660 format

This is the international standard for the format logic of CD-ROM folders and files. For the ISO9660 format, there are regulations for the following two levels.

Level 1:

The file name is in 8.3 format (the name consists of up to 8 characters, half-byte English capital letters and half-byte numerals and the “_” sign, with a file-extension of three characters).

Level 2:

The file name can have up to 31 characters (including the separation mark “.” and a file extension). Each folder contains less than 8 hierarchies.

Extended formats

Joliet: File names can have up to 64 characters.

Romeo: File names can have up to 128 characters.

Linear PCM (LPCM)/Pulse code modulation

This stands for linear pulse code modulation, which is the signal recording system used for music CDs and DVDs.

m3u

Playlists created using the “WINAMP” software have a playlist file extension (.m3u).

Additional Information

MP3

MP3 is short for MPEG Audio Layer 3. It is an audio compression standard set by a working group (MPEG) of the ISO (International Standards Organization). MP3 is able to compress audio data to about 1/10th the level of a conventional disc.

MS ADPCM

This stands for Microsoft adaptive differential pulse code modulation, which is the signal recording system used for the multimedia software of Microsoft Corporation.

Multi-session

Multi-session is a recording method that allows additional data to be recorded later. When recording data on a CD-ROM, CD-R or CD-RW, etc., all data from beginning to end is treated as a single unit or session. Multi-session is a method of recording more than 2 sessions on one disc.

Number of quantization bits

The number of quantization bits is one factor in the overall sound quality; the higher the "bit-depth", the better the sound quality. However, increasing the bit-depth also increases the amount of data and therefore storage space required.

Packet write

This is a general term for a method of writing on CD-R, etc., at the time required for a file, just as is done with files on floppy or hard discs.

VBR

VBR is short for variable bit rate. Generally speaking CBR (constant bit rate) is more widely used. But by flexibly adjusting the bit rate according to the needs of audio compression, it is possible to achieve compression-priority sound quality.

WAV

WAV is short for waveform. It is a standard audio file format for Windows®.

WMA

WMA is short for Windows Media™ Audio and refers to an audio compression technology that is developed by Microsoft Corporation. WMA data can be encoded by using Windows Media Player version 7 or later.

Windows Media and the Windows logo are trademarks or registered trademarks of Microsoft Corporation in the United States and/or other countries.

Specifications

General

Power source 14.4 V DC (10.8 – 15.1 V allowable)
Grounding system Negative type
Max. current consumption 10.0 A
Dimensions (W × H × D):	
DIN	
Chassis 178 × 50 × 157 mm
Nose 188 × 58 × 19 mm
D	
Chassis 178 × 50 × 162 mm
Nose 170 × 48 × 14 mm
Weight 1.3 kg

Audio

Maximum power output 50 W × 4 50 W × 2/4 Ω + 70 W × 1/2 Ω (for subwoofer)
Continuous power output 27 W × 4 (DIN 45324, +B=14.4 V)
Load impedance 4 – 8 Ω × 4 4 – 8 Ω × 2 + 2 Ω × 1
Preout max output level/ output impedance 2.2 V/1 kΩ
Equalizer (3-Band Parametric Equalizer):	
Low	
Frequency 40/80/100/160 Hz
Q Factor 0.35/0.59/0.95/1.15 (+6 dB when boosted)
Gain ±12 dB
Mid	
Frequency 200/500/1k/2k Hz
Q Factor 0.35/0.59/0.95/1.15 (+6 dB when boosted)
Gain ±12 dB
High	
Frequency 3.15k/8k/10k/12.5k Hz
Q Factor 0.35/0.59/0.95/1.15 (+6 dB when boosted)
Gain ±12 dB
Loudness contour:	
Low +3.5 dB (100 Hz), +3 dB (10 kHz)
Mid +10 dB (100 Hz), +6.5 dB (10 kHz)
High +11 dB (100 Hz), +11 dB (10 kHz) (volume: -30 dB)
HPF:	
Frequency 50/63/80/100/125 Hz
Slope -12 dB/oct

Note

- Specifications and the design are subject to possible modifications without notice due to improvements.

Subwoofer:

Frequency 50/63/80/100/125 Hz
Slope -18 dB/oct
Gain +6 – -24 dB
Phase/Reverse Normal/Reverse
Bass boost:	
Gain +12 – 0 dB

CD player

System Compact disc audio system
Usable discs Compact disc
Signal format:	
Sampling frequency 44.1 kHz
Number of quantization bits 16; linear
Frequency characteristics 5 – 20 000 Hz (±1 dB)
Signal-to-noise ratio 94 dB (1 kHz) (IEC-A network)
Dynamic range 92 dB (1 kHz)
Number of channels 2 (stereo)
MP3 decoding format MPEG-1 & 2 Audio Layer 3
WMA decoding format Ver. 7, 7.1, 8, 9, 10 (2ch audio)
WAV signal format Linear PCM & MS ADPCM (Windows Media Player)

FM tuner

Frequency range 87.5 – 108.0 MHz
Usable sensitivity 8 dBf (0.7 μV/75 Ω mono, S/N: 30 dB)
50 dB quieting sensitivity 10 dBf (0.9 μV/ 75 Ω, mono)
Signal-to-noise ratio 75 dB (IEC-A network)
Distortion 0.3 % (at 65 dBf, 1 kHz, stereo) 0.1 % (at 65 dBf, 1 kHz, mono)
Frequency response 30 – 15 000 Hz (±3 dB)
Stereo separation 45 dB (at 65 dBf, 1 kHz)
Selectivity 80 dB (±200 kHz)

MW tuner

Frequency range 531 – 1 602 kHz (9 kHz)
Usable sensitivity 18 μV (S/N: 20 dB)
Signal-to-noise ratio 65 dB (IEC-A network)

LW tuner

Frequency range 153 – 281 kHz
Usable sensitivity 30 μV (S/N: 20 dB)
Signal-to-noise ratio 65 dB (IEC-A network)

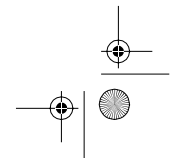
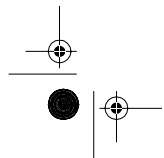
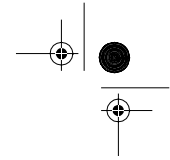
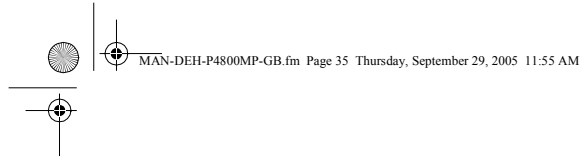



PIONEER CORPORATION
4-1, MEGURO 1-CHOME, MEGURO-KU, TOKYO 153-8654, JAPAN

PIONEER ELECTRONICS (USA) INC.
P.O. Box 1540, Long Beach, California 90801-1540, U.S.A.
TEL: (800) 421-1404

PIONEER EUROPE NV
Haven 1087, Keerbergaan 1, B-9120 Meisele, Belgium

TEL: (0) 3/570.05.11

PIONEER ELECTRONICS ASIACENTRE PTE. LTD.
253 Alexandra Road, #04-01, Singapore 159936

TEL: 65-6472-7555

PIONEER ELECTRONICS AUSTRALIA PTY. LTD.
178-184 Boundary Road, Braeside, Victoria 3195, Australia

TEL: (03) 9586-6300

PIONEER ELECTRONICS OF CANADA, INC.
300 Alstair Parkway, Markham, Ontario L3R 0P2, Canada

TEL: 1-877-283-5901

PIONEER ELECTRONICS DE MEXICO, S.A. de C.V.
Bvd. Manuel Avila Camacho 138 10 piso

Col. Lomas de Chapultepec, Mexico, D.F. 11000

TEL: 55-9178-4270

先鋒股份有限公司

總公司: 台北市中山北路二段44號13樓

電話: (02) 2521-3388

先鋒電子(香港)有限公司

香港九龍尖沙咀海城世界商業中心9樓901-6室

電話: (0852) 2848-6488

Published by Pioneer Corporation.
Copyright © 2005 by Pioneer Corporation.
All rights reserved.

Printed in Belgium
MAN-DEH-P480MP-GB

