

# ALTUSCEN™

Enterprise KVM Solutions by ATEN

## Power over the NET™ PN0108 User Manual



## FCC Information

---

This is an FCC Class A product. In a domestic environment this product may cause radio interference in which case the user may be required to take adequate measures.

This equipment has been tested and found to comply with the limits for a Class A digital device, pursuant to Part 15 of the FCC Rules. These limits are designed to provide reasonable protection against harmful interference when the equipment is operated in a commercial environment. This equipment generates, uses and can radiate radio frequency energy and, if not installed and used in accordance with the instruction manual, may cause harmful interference to radio communications. Operation of this equipment in a residential area is likely to cause harmful interference in which case the user will be required to correct the interference at his own expense.

## RoHS

---

This product is RoHS compliant.



## User Notice

---

All information, documentation, and specifications contained in this manual are subject to change without prior notification by the manufacturer. The manufacturer makes no representations or warranties, either expressed or implied, with respect to the contents hereof and specifically disclaims any warranties as to merchantability or fitness for any particular purpose. Any of the manufacturer's software described in this manual is sold or licensed 'as is'. Should the programs prove defective following their purchase, the buyer (and not the manufacturer, its distributor, or its dealer), assumes the entire cost of all necessary servicing, repair and any incidental or consequential damages resulting from any defect in the software.

The manufacturer of this system is not responsible for any radio and/or TV interference caused by unauthorized modifications to this device. It is the responsibility of the user to correct such interference.

The manufacturer is not responsible for any damage incurred in the operation of this system if the correct operational voltage setting was not selected prior to operation. **PLEASE VERIFY THAT THE VOLTAGE SETTING IS CORRECT BEFORE USE.**

## Safety Instructions

---

### General

- ◆ Read all of these instructions. Save them for future reference.
- ◆ Follow all warnings and instructions marked on the device.
- ◆ Do not place the device on any unstable surface (cart, stand, table, etc.). If the device falls, serious damage will result.
- ◆ Do not use the device near water.
- ◆ Do not place the device near, or over, radiators or heat registers.
- ◆ The device cabinet is provided with slots and openings to allow for adequate ventilation. To ensure reliable operation, and to protect against overheating, these openings must never be blocked or covered.
- ◆ The device should never be placed on a soft surface (bed, sofa, rug, etc.) as this will block its ventilation openings. Likewise, the device should not be placed in a built in enclosure unless adequate ventilation has been provided.
- ◆ Never spill liquid of any kind on the device.
- ◆ Unplug the device from the wall outlet before cleaning. Do not use liquid or aerosol cleaners. Use a damp cloth for cleaning.
- ◆ The device should be operated from the type of power source indicated on the marking label. If you are not sure of the type of power available, consult your dealer or local power company.
- ◆ The device is equipped with a 3-wire grounding type plug. This is a safety feature. If you are unable to insert the plug into the outlet, contact your electrician to replace your obsolete outlet. Do not attempt to defeat the purpose of the grounding-type plug. Always follow your local/national wiring codes.
- ◆ Do not allow anything to rest on the power cord or cables. Route the power cord and cables so that they cannot be stepped on or tripped over.
- ◆ If an extension cord is used with this device make sure that the total of the ampere ratings of all products used on this cord does not exceed the extension cord ampere rating. Make sure that the total of all products plugged into the wall outlet does not exceed 15 amperes.
- ◆ To help protect your system from sudden, transient increases and decreases in electrical power, use a surge suppressor, line conditioner, or uninterruptible power supply (UPS).

- ◆ Position system cables and power cables carefully; Be sure that nothing rests on any cables.
- ◆ When connecting or disconnecting power to hot pluggable power supplies, observe the following guidelines:
- ◆ Install the power supply before connecting the power cable to the power supply.
- ◆ Unplug the power cable before removing the power supply.
- ◆ If the system has multiple sources of power, disconnect power from the system by unplugging all power cables from the power supplies.
- ◆ Never push objects of any kind into or through cabinet slots. They may touch dangerous voltage points or short out parts resulting in a risk of fire or electrical shock.
- ◆ Do not attempt to service the device yourself. Refer all servicing to qualified service personnel.
- ◆ If the following conditions occur, unplug the device from the wall outlet and bring it to qualified service personnel for repair.
  - ◆ The power cord or plug has become damaged or frayed.
  - ◆ Liquid has been spilled into the device.
  - ◆ The device has been exposed to rain or water.
  - ◆ The device has been dropped, or the cabinet has been damaged.
  - ◆ The device exhibits a distinct change in performance, indicating a need for service.
  - ◆ The device does not operate normally when the operating instructions are followed.
- ◆ Only adjust those controls that are covered in the operating instructions. Improper adjustment of other controls may result in damage that will require extensive work by a qualified technician to repair.

## **Rack Mounting**

- ◆ Before working on the rack, make sure that the stabilizers are secured to the rack, extended to the floor, and that the full weight of the rack rests on the floor. Install front and side stabilizers on a single rack or front stabilizers for joined multiple racks before working on the rack.
- ◆ Always load the rack from the bottom up, and load the heaviest item in the rack first.
- ◆ Make sure that the rack is level and stable before extending a device from the rack.
- ◆ Use caution when pressing the device rail release latches and sliding a device into or out of a rack; the slide rails can pinch your fingers.
- ◆ After a device is inserted into the rack, carefully extend the rail into a locking position, and then slide the device into the rack.
- ◆ Do not overload the AC supply branch circuit that provides power to the rack. The total rack load should not exceed 80 percent of the branch circuit rating.
- ◆ Ensure that proper airflow is provided to devices in the rack.
- ◆ Do not step on or stand on any device when servicing other devices in a rack.

## **Power Cords**

Use the cables supplied with this package. If it becomes necessary to replace the cables supplied with this package, be sure to use cables of at least the same standard as the ones provided.

### **Power Cord:**

For models with a 220 - 240 V AC power supply, use a tandem (T blade) type attachment plug with ground connector power cord that meets the respective European country's safety regulations, such as VDE for Germany. The plug should comply with the VDE 0620 specification; the connector should comply with the VDE 0625 specification. A minimum 10 A, 0.75 mm<sup>2</sup> x 3G power cord (H05VV-F or VW-1) should be used.

### **Power Outlet Cords:**

For models with a 220 - 240 V AC power supply, the connector should comply with the VDE 0625 or EN60320 specification. A minimum 10 A, 0.75 mm<sup>2</sup> x 3G power cord (H05VV-F or VW-1) should be used.

## Package Contents

---

The PN0108 package consists of:

- 1 PN0108 Station
- 1 AC Source Power Cord
- 8 Power Outlet Power Cords
- 8 Safe Shutdown Cables
- 1 PON Cable (DB9 F to DB9 M)
- 1 Rack Mount Kit (Brackets and Phillips head hex M3 x 8 screws)
- 1 Foot Pad Set (4 pcs.)
- 1 Software CD
- 1 User Manual\*
- 1 Quick Start Guide
- 1 Warranty Registration Card

Check to make sure that all of the components are present and in good order. If anything is missing, or was damaged in shipping, contact your dealer.

Read this manual thoroughly and follow the installation and operation procedures carefully to prevent any damage to the switch or to any other devices on the PN0108 installation.

---

\* Features may have been added to the PN0108 since this manual was printed. Please visit our website to download the most up-to-date version of the manual.

---

Copyright © 2004-2007 ATEN® International Co., Ltd.  
Manual Part No. PAPE-0239-3AXG  
Printing Date:02/2007

Altusen and the Altusen logo are registered trademarks of ATEN International Co., Ltd. All rights reserved.  
All other brand names and trademarks are the registered property of their respective owners.



# Contents

---

FCC Information . . . . .	ii
RoHS . . . . .	ii
User Notice . . . . .	iii
Safety Instructions . . . . .	iv
General . . . . .	iv
Rack Mounting . . . . .	vi
Power Cords . . . . .	vii
Package Contents . . . . .	viii
About This Manual . . . . .	xii
Overview . . . . .	xii
Conventions . . . . .	xiii
ALTUSEN Information . . . . .	xiv
Online Registration . . . . .	xiv
Technical Support . . . . .	xiv
Product Information . . . . .	xv

## **Chapter 1.**

### **Introduction**

Overview . . . . .	1
Features . . . . .	1
Requirements . . . . .	2
Components . . . . .	3
Front View . . . . .	3
Rear View . . . . .	5

## **Chapter 2.**

### **Hardware Setup**

Before You Begin . . . . .	7
Stacking and Rack Mounting . . . . .	7
Stacking . . . . .	7
Rack Mounting . . . . .	8
Single Stage Installation . . . . .	10
Daisy Chaining . . . . .	12

## **Chapter 3.**

### **Browser Operation**

Logging In . . . . .	13
The PN9108 Main Screen . . . . .	14
Device Selector . . . . .	15
Device Control . . . . .	15
The Power Status Screen . . . . .	16
The Top Panel . . . . .	16
The Bottom Panel . . . . .	18

## **Chapter 4.**

### **Administration**

Working Environment Configuration . . . . .	19
General . . . . .	19
Network . . . . .	21
Date / Time . . . . .	24
Firmware . . . . .	25
Logout . . . . .	25
Power Management Configuration . . . . .	26
Configuration . . . . .	26
Schedule . . . . .	31
User Management . . . . .	32
Monitor . . . . .	33
Log . . . . .	34

## **Chapter 5.**

### **Safe Shutdown and Reboot**

Overview . . . . .	37
Automated Setup . . . . .	38
Installation . . . . .	38
Uninstalling . . . . .	39
Manual Setup . . . . .	40
Windows 2000 / XP / Server 2003: . . . . .	40
NT: . . . . .	42

## **Chapter 6.**

### **Out of Band Operation**

OOB Configuration . . . . .	43
Computer Connection . . . . .	44
Modem Connection . . . . .	45
Dialog Box Buttons . . . . .	47
Direct Terminal Connection (HyperTerminal) . . . . .	48
HyperTerminal Setup . . . . .	48
Logging In . . . . .	51
Indirect Terminal Connection (HyperTerminal) . . . . .	52
Connection Setup . . . . .	52
Final Check . . . . .	53
Logging In . . . . .	54
Direct Dial In Connection (PPP) . . . . .	55
Connection Setup . . . . .	55
Finishing Up . . . . .	58
Logging In . . . . .	59
Indirect Dial In Connection (PPP) . . . . .	60
Connection Setup . . . . .	60
Finishing Up . . . . .	61
Logging In . . . . .	61

---

Dial Out Connection . . . . .	62
Connection Setup . . . . .	62
Logging In . . . . .	63
Telnet . . . . .	64
Terminal Access . . . . .	64
Browser Access . . . . .	64

## **Chapter 7.**

### **Upgrading The Firmware**

Preparation . . . . .	65
Starting the Upgrade . . . . .	66

## **Appendix**

IP Address Determination . . . . .	67
Troubleshooting . . . . .	70
Trusted Certificates . . . . .	73
Overview . . . . .	73
Installing the Certificate . . . . .	74
Certificate Trusted . . . . .	75
Administrator Login Failure . . . . .	76
Specifications . . . . .	77
Null Modem Cable Diagrams . . . . .	78
Battery Replacement . . . . .	78
Limited Warranty . . . . .	79

## About This Manual

---

This User Manual is provided to help you get the most from your PN0108 system. It covers all aspects of installation, configuration and operation. An overview of the information found in the manual is provided below.

### Overview

**Chapter 1, Introduction**, introduces you to the PN0108 system. Its purpose, features and benefits are presented, and its front and back panel components are described.

**Chapter 2, Hardware Setup**, provides step-by-step instructions for setting up your installation.

**Chapter 3, Logging In**, describes the various methods that can be used to access the PN0108.

**Chapter 4, Operation**, explains how to set up and operate the PN0108 once you are logged in.

**Chapter 5, Administration**, describes the administrative procedures that are employed to configure the PN0108's working environment.

**Chapter 6, Safe Shutdown and Reboot**, shows you how to safely close a system down and reboot your devices without involving the danger to the file systems that simply killing the power supply does.

**Chapter 7, Upgrading The Firmware**, explains how to upgrade the PN0108's firmware with the latest available versions.

**An Appendix**, provides specifications and other technical information regarding the PN0108.

## **Conventions**

This manual uses the following conventions:

- |   |  |
|---|--|
| Monospaced  | Indicates text that you should key in.   |
| [ ]   | Indicates keys you should press. For example, [Enter] means to press the <b>Enter</b> key. If keys need to be chorded, they appear together in the same bracket with a plus sign between them: [Ctrl+Alt]. |
| 1.  | Numbered lists represent procedures with sequential steps.   |
| ◆   | Bullet lists provide information, but do not involve sequential steps.   |
| →   | Indicates selecting the option (on a menu or dialog box, for example), that comes next. For example, Start → Run means to open the <i>Start</i> menu, and then select <i>Run</i> .                         |
|  | Indicates critical information.  |

## ALTUSEN Information

---

### Online Registration

You can register your ALTUSEN product at our online e-Support Center:  
<http://support.aten.com>.

### Technical Support

North America Technical Phone Support	Registered ALTUSEN product owners are entitled to telephone technical support. Call the ALTUSEN Technical Support Center: 949-453-8885.
International Technical Phone Support	8. Contact your local dealer. 9. Call the ALTUSEN Technical Support Center:(886-2) 8692-6959.
Email Support	Email your questions and concerns to: support@aten.com
Online Support <ul style="list-style-type: none"> <li>◆ Technical Support</li> <li>◆ Troubleshooting</li> <li>◆ Documentation</li> <li>◆ Software Updates</li> </ul>	10. Online technical support is available to ALTUSEN customers through our e-Support Center: <a href="http://support.aten.com">http://support.aten.com</a> .  11. Online troubleshooting that describes the most commonly encountered problems and offers possible solutions to them; online documentation (including electronically available manuals); and the latest drivers and firmware for your product are available at the ALTUSEN website: <a href="http://www.aten.com">http://www.aten.com</a>

When you contact ALTUSEN technical support with a problem, please have the following information ready beforehand:

- ◆ Product model number, serial number, and date of purchase.
- ◆ Your computer configuration, including operating system, revision level, expansion cards, and software.
- ◆ Any error messages displayed at the time the error occurred.
- ◆ The sequence of operations that led up to the error.
- ◆ Any other information you feel may be of help

## **Product Information**

For information about all of ALTUSEN's products and how they can help you connect without limits, visit ALTUSEN on the web or contact an ALTUSEN Authorized Reseller.

- ◆ In the United States of America, call: 866-ALTUSEN (258-8736)
- ◆ In Canada and South America, call: 949-453-8885
- ◆ In all other locations, call: 886-2-8692-6789
- ◆ Visit ALTUSEN on the web at <http://www.aten.com> for a list of locations and telephone numbers

This Page Intentionally Left Blank



# Chapter 1 Introduction

## Overview

---

The PN0108 Power Over the NET™ is a control unit that offers remote power management for up to eight devices (computers, hubs, routers, etc.). When connected to an ATEN or Altusen TCP/IP accessible module via its PON (RS232) port – see the diagram below – it allows administrators from any computer connected to the internet, whether down the hall, or half way around the world – to control the power off, power on, and reboot status for each attached device. See *Supported Devices*, page 62 for a list of compatible ATEN/ALTUSEN devices.

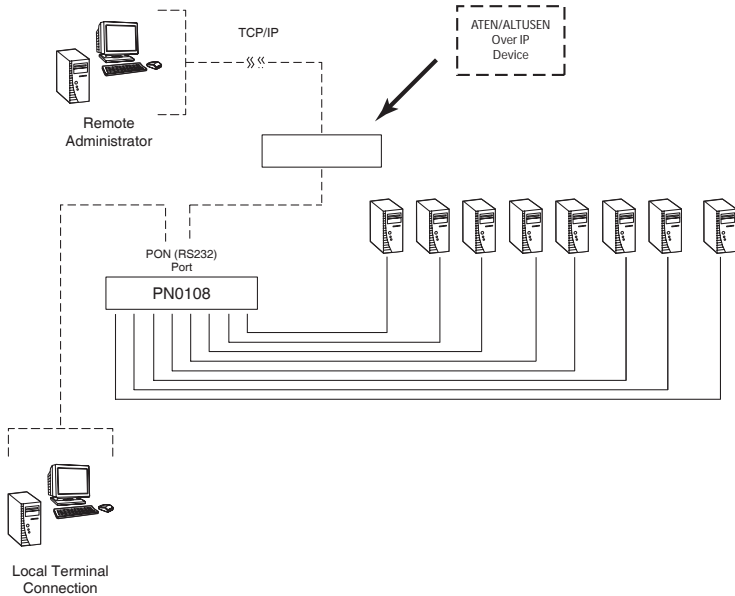

For flexibility, the PON port can also be used to administer the PN0108 locally via a serial terminal session.

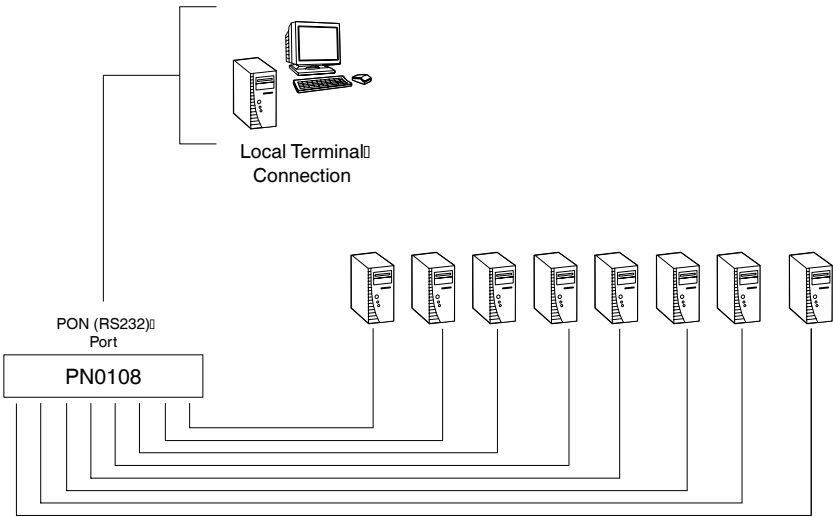

Up to 15 additional PN0108 units can be daisy chained down from the original unit, providing remote power management for up to 128 devices. Installation is fast and easy: plugging cables into their appropriate ports and a simple setup is all that is entailed.

Since the PN0108's firmware is upgradeable, you can stay current with the latest functionality improvements simply by downloading firmware updates from our website as they become available.

With its advanced features and ease of operation, the PN0108 is the most convenient, most reliable, and most cost effective way to remotely manage power access for multiple computer installations.

## Features

---

- ◆ Remote power on/off/reboot control for eight outlets via TCP/IP and a built in RS-232 PON (Power over the Net™) port
- ◆ Local power on/off/reboot control via the PN0108's PON port to the computer's RS-232 port
- ◆ Daisy chain up to 15 additional stations to control up to 128 outlets
- ◆ Manual switching between Local and Remote access for each port via front panel push button switches
- ◆ Individual control of each port – users can set the power on sequence and delay time for each port to allow equipment to be turned on in the proper order
- ◆ Easy setup and operation via a GUI interface
- ◆ Provides three configuration/management methods: Browser; Telnet; or Console Terminal
- ◆ Safe shutdown and rebooting for Windows systems\*
- ◆ Overcurrent protection and recovery for each AC port (110 V model only); total port overcurrent protection (both models) – remote users can monitor the current status via the GUI interface
- ◆ Separate circuits for the unit's power and the power to the devices – the power control status menu is still accessible even when an overcurrent condition trips the devices' circuit breaker
- ◆ On/Off scheduling – allows everything from a one-time start/shutdown, to daily, weekly, etc. starts/shutdowns at user-specified times
- ◆ Port grouping – perform the same action on a specified group of ports
- ◆ LEDs for easy status monitoring
- ◆ Two level (Administrator and User) security
- ◆ Configuration can be reset
- ◆ Firmware upgradeable – daisy chained stations receive the upgrade via the daisy chain bus

---

\* Safe shutdown and rebooting is supported if the *Power Monitor* utility has been installed (see *Automated Setup*, page 48).

---

## Requirements

---

- ◆ Browsers accessing the PN0108 must support SSL 128 bit encryption.
- ◆ For the Java access, you must have Java J2RE (1.4 or higher) installed on your computer. Java is available for free download from the Sun Java website: *http://java.sun.com*
- ◆ For cold booting of attached computers, the computer's BIOS must support this feature.
- ◆ For Safe Shutdown:
  - ◆ The computer must be running Windows (Windows 98 or higher).
  - ◆ The computer's BIOS must support Safe Shutdown – see *Overview*, page 47, for detailed information.
  - ◆ There must be an available COM port on the computer for the Safe Shutdown cable to plug into.

# Components

## Front View

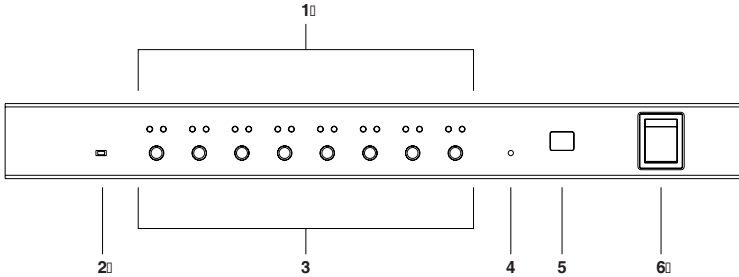

No.	Item	Description
1	Port LEDs	<p>The Port LEDs provide status information about their corresponding AC outlet ports. There is one pair of LEDs for each port. The one on the left is the <i>Remote Access LED</i>; the one on the right is the <i>Power LED</i>:</p> <ul style="list-style-type: none"> <li>◆ A <i>Remote Access LED</i> lights GREEN to indicate that the device attached to its corresponding port is capable of being controlled remotely.</li> <li>◆ A <i>Power LED</i> lights ORANGE to indicate that there is electricity going to its corresponding outlet. The LED flashes under the following conditions: <ul style="list-style-type: none"> <li>◆ If <i>Modem Ring Resume</i> is enabled (see <i>Modem Ring Resume*</i>, page 39), the outlet still receives electricity even when it is OFF. The Power LED blinks OFF, then ON for 8 seconds, then repeats this sequence to indicate this situation.</li> <li>◆ When a power status change is pending, the LED flashes until the change has taken place.</li> </ul> </li> <li>◆ If both LEDs flash it indicates that there is either an overcurrent situation, or the relay has failed. See <i>Flashing Lightbulb</i>, page 33, for more details.</li> </ul>
2	Firmware Upgrade Switch	<p>During normal operation this switch is in the NORMAL position. The RECOVER position is used when performing a firmware upgrade. See <i>Upgrading The Firmware</i>, page 53, for upgrading details.</p>

(Continues on next page.)

(Continued from previous page.)

No.	Item	Description
3	Power Control Buttons	<p>Each button (A to H), controls the power status of its corresponding AC output port as follows:</p> <ul style="list-style-type: none"><li>◆ Pressing the button for less than 3 seconds toggles the port between Remote Access enabled and Remote Access disabled (Local Mode). If Remote Access is disabled, the switch does not allow the port to be managed from a remote connection. (The Remote Access LED is off when Remote Access Mode has been disabled for its corresponding port.)</li><li>◆ Under Local Mode, pressing and holding the button in for more than 3 seconds switches the power to its corresponding port On or Off.</li></ul>
4	Reset Switch	Pressing and holding this switch in for more that three seconds resets the PN9108 to its factory default settings. This switch is recessed and must be pushed with a thin object, such as the end of a paper clip, or a ballpoint pen.
5	Station ID LED	The PN0108's Station ID displays here. If this is a Single Station installation (See <i>Single Stage Installation</i> , page 11, or the First Station on a Daisy Chained installation (see <i>Daisy Chaining</i> , page 13), the PN0108 has a Station ID of <b>01</b> .
6	Power Switch	This standard rocker switch powers the PN0108 On and Off.

## Rear View

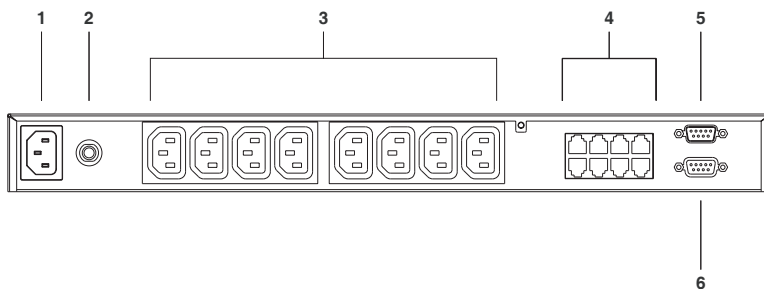

No.	Item	Description
1	Power Socket	The power cable from the AC source plugs in here.
2	Circuit Breaker	Press to reset the circuit.
3	AC Power Outlets	The power cables that connect to the computers plug in here.
4	Safe Shutdown Ports	Provides safe shutdown and rebooting for Windows 98SE, ME, NT, 2000, XP and 2003 Server systems.
5	PON (Power over the NET™) Output Port	When daisy chaining PN9108 Stations, this is the Chain Out port. See p. 13 for daisy chaining details.
6	PON Input Port	<ul style="list-style-type: none"> <li>◆ For a single unit installation, or for the first station of a daisy chained installation, the PON cable that connects to the CN-6000 (or other compatible device - see <i>Supported Devices</i>, page 62), plugs in here.</li> <li>◆ In a daisy chained installation, the PON cable from the Chain Out port of the parent unit plugs in here.</li> <li>◆ When performing a firmware upgrade, the PON cable that connects the PN0108 to the computer that will transfer the upgraded firmware (see <i>Preparation</i>, page 53), plugs in here.</li> </ul>

This Page Intentionally Left Blank



# Chapter 2

## Hardware Setup

### Before You Begin

---



1. Important safety information regarding the placement of this device is provided on page iv. Please review it before proceeding.
2. Make sure that power to all the devices you will be connecting up have been turned off. You must unplug the power cords of any computers that have the Keyboard Power On function.

### Stacking and Rack Mounting

---

#### Stacking

The PN0108 can be placed on any appropriate level surface that can safely support its weight plus the weight of its attached cables. To place or stack the PN0108, remove the backing material from the bottom of the rubber feet that came with this package, and stick them onto the switch's bottom panel at the corners, as shown in the diagram, below

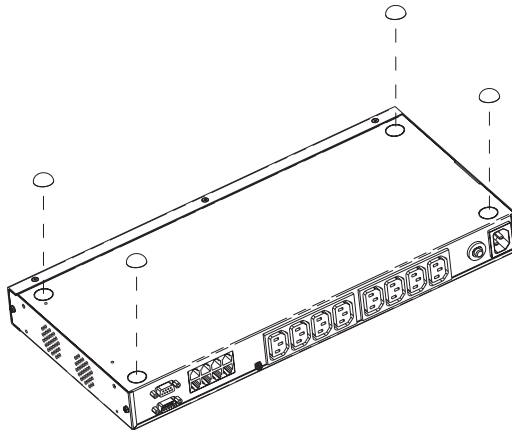

---

**Note:** To ensure adequate ventilation, allow at least 5.1 cm on each side, and 12.7cm at the back for power cord and cable clearance.

---

## **Rack Mounting**

The PN0108 can be installed in most standard 19" (1U) racks. To rack mount the unit do the following:

1. Use the screws supplied with your rack mounting kit to attach the rack mounting brackets to each side of the device:

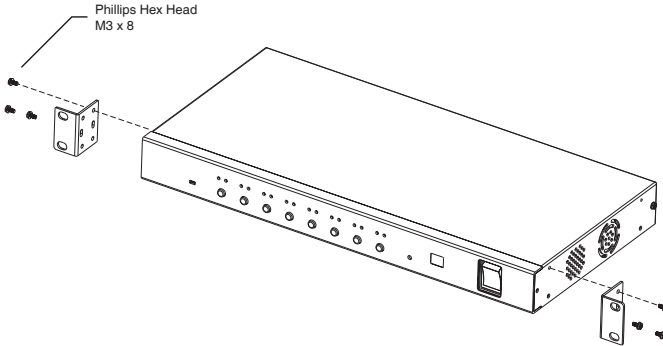

---

**Note:** The unit can be installed either at the front or the back of the rack. To install it at the back, simply screw the brackets into the holes at the rear of the unit.

---

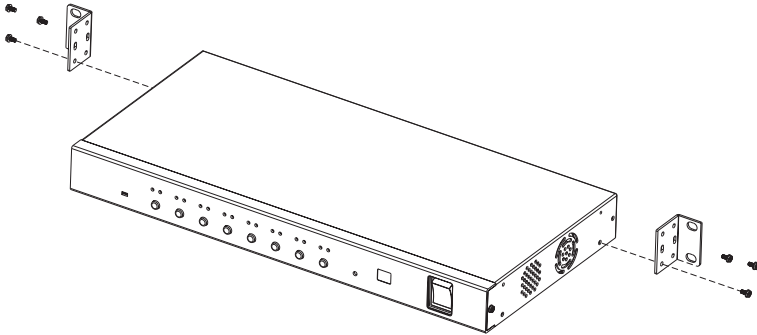

2. Position the device in the rack and align the holes in the mounting brackets with the hole in the rack.
3. Screw the mounting brackets to the rack.

---

**Note:** Cage nuts are provided for racks that are not prethreaded.

---

## Single Stage Installation

---

In a Single Stage installation, there are no additional PN0108s daisy chained down from the first unit. To set up a single stage installation, refer to the installation diagram below (the numbers in the diagram correspond to the numbered steps), and do the following:

1. Use the PON cable that was provided with this package to connect the PN0108's PON **IN** port to the CN-6000's (or other compatible device - see *Supported Devices*, page 62) PON port.
2. For each device, use one of the AC Outlet power cords supplied with this package to connect from any available PN0108 output port to the device's AC socket. See *Power Cords*, page vii, for power cord safety information.
3. Safe Shutdown is supported for computers running Windows 98SE, ME, NT, 2000, XP, and Windows Server 2003.

If you choose to utilize the Safe Shutdown feature (use of this feature is optional), for each computer use a Safe Shutdown cable to connect from the PN0108's Safe Shutdown port to the computer's serial port.

---

**Note:** You must connect the computer to the same letter designation for both the AC Outlet and Safe Shutdown ports.

---

4. Use the AC power cord provided with this package to connect the PN0108's Power Socket to an AC power source. See *Power Cords*, page vii, for power cord safety information.
5. Turn on the PN0108.
6. Turn on the devices.

## Single Stage Installation Diagram

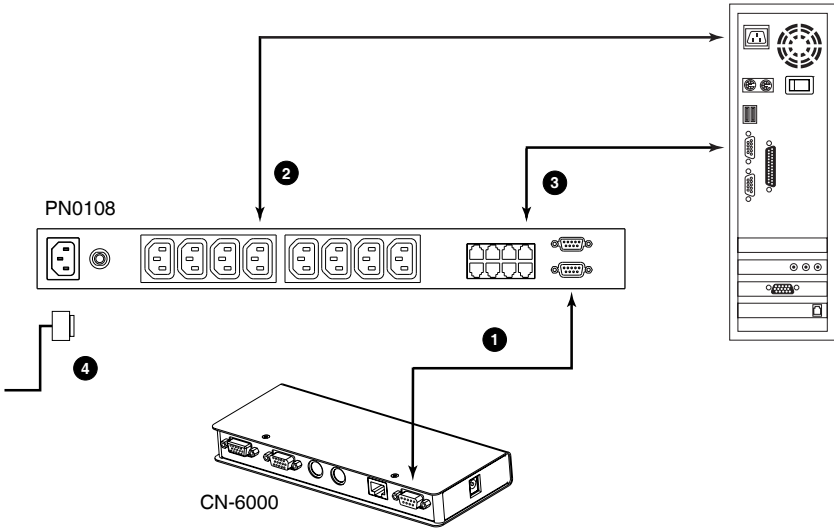



This Page Intentionally Left Blank

# Chapter 3

## Logging In

### Overview

---

Depending on your installation's components, the PN0108 can be accessed in various ways: via a browser connection to an ATEN/ALTUSEN internet enabled KVM switch (see *Supported Devices*, page 62 for a list of supported switches); a browser connection to a PN9108 or SN0108/SN0116; or from a local computer using a terminal program (such as Hyperterminal), or a Java application. The sections that follow explain how to connect with each method.

### CN-6000 Browser Login

---

#### Logging In

Remote operation of the PN0108 via a CN6000 (or other internet enabled KVM switch), is browser based. It involves invoking a java program by clicking an icon on the switch's web page.

For example purposes, we will access a PN0108 connected to a CN6000 KVM on the NET™ module.

---

**Note:** 1. The browser must support 128 bit SSL encryption.

2. You must have Java 1.4 or higher installed on your computer. Java is available for free download from the Sun Java website:

<http://java.sun.com>

---

1. In the browser's URL location bar, specify the IP address of the CN6000 that the PN0108 you want to access is connected to. (If you don't know the IP address, get it from the CN6000 administrator.)

- When the Security Alert dialog box appears, accept the certificate – it can be trusted. (See *Trusted Certificates*, page 64, for details.) The Login page appears:



- Provide a valid Username and Password (set by the CN-6000 administrator), then Click **Login** to continue.
- After you have successfully logged in, Click the *Power Management* icon.

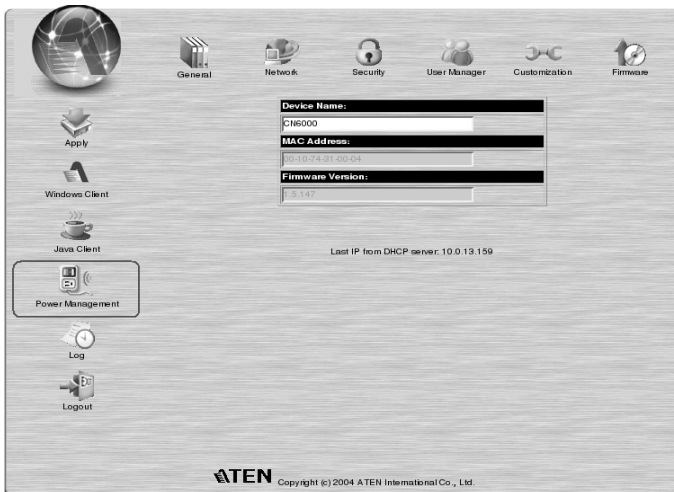



5. A *File Download* dialog box comes up asking what you want to do with the `PowerMan.jar` file. You can either run it from your browser (click *Open*), or save it to disk and run it from your computer. If your browser permits, run it from your browser.
6. If you save the file and run it from your computer, **with your browser still open**, go to the directory where the `PowerMan.jar` file resides and either double click its icon, or, from a command window, enter the following command:

```
java -jar PowerMan.jar
```

7. The PN0108 login dialog box comes up:



The image shows a login dialog box titled "PN0108 Login". It features two input fields labeled "Username:" and "Password:". Below these fields are two buttons: "Login" and "Reset". At the bottom of the dialog, the ALTUSCN logo is displayed with the tagline "Connect Without Limits™".

Provide a valid Username and Password (set by the PN0108 administrator), then Click **Login** to continue.

---

**Note:** If you are the administrator, and are logging in for the first time, use the default Username: *administrator*; and the default Password: *password*. For security purposes, we strongly recommend you remove these and give yourself a unique Username and Password (see *System Setup*, page 37).

---

PN0108 operating procedures are discussed in Chapter 4, *Operation*.

## PN9108 Browser Operation

---

### Logging In

Remote operation of the PN0108 via a PN9108 is browser based. It involves logging into the PN9108's web page, and selecting the PN0108 from the PN9108's Device Selector list.

---

**Note:** The browser must support 128 bit SSL encryption.

---

1. In the browser's URL location bar, specify the IP address of the PN9108 that the PN0108 you want to access is connected to. (If you don't know the IP address, get it from the PN9108 administrator.)
2. When the Security Alert dialog box appears, accept the certificate – it can be trusted. (See *Trusted Certificates*, page 64, for details.)
3. A login dialog box, like the one below, appears:

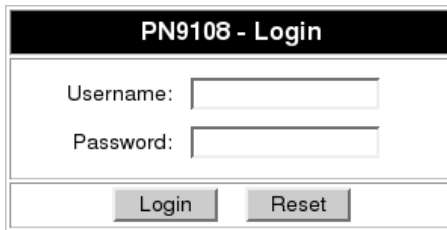

The image shows a login dialog box titled "PN9108 - Login". It contains two input fields: "Username:" and "Password:". Below the input fields are two buttons: "Login" and "Reset".

4. Provide a valid Username and Password (set by the PN9108 administrator), then Click **Login** to continue.

## The PN9108 Main Screen

After you have successfully logged in, the PN9108 Main Screen appears:

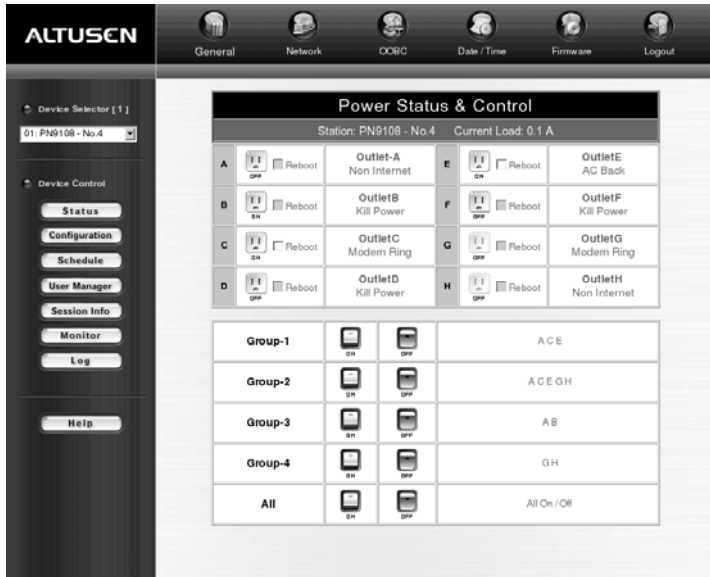

Select the PN0108 that you want to access from the PN9108's Device Selector list.



PN0108 operating procedures are discussed in Chapter 4, *Operation*.

## SN0108 / SN0116 Browser Operation

---

### Logging In

Remote operation of the PN0108 via a SN0108 / SN0116 is browser based. The first step involves logging into the SN0108 / SN0116's web page, as follows:

---

**Note:** 1. The browser must support 128 bit SSL encryption.

2. You must set the port parameters on the SN0108 / SN0116 port that the PN0108 connects to as follows: Bps: 384000; Data bits: 8; Parity: None; Stop bits: 1; Flow control: None.

---

1. In the browser's URL location bar, specify the IP address of the SN0108 / SN0116 that the PN0108 you want to access is connected to. (If you don't know the IP address, get it from the SN0108 / SN0116 administrator.)
2. When the Security Alert dialog box appears, accept the certificate – it can be trusted. (See *Trusted Certificates*, page 64, for details.)
3. A login dialog box, like the one below, appears:

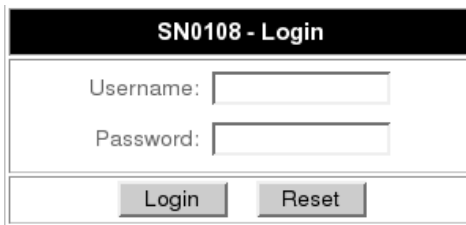

The image shows a login dialog box titled "SN0108 - Login". It contains two input fields: "Username:" and "Password:". Below the input fields are two buttons: "Login" and "Reset".

4. Provide a valid Username and Password (set by the SN0108 / SN0116 administrator), then Click **Login** to continue.

## The SN0108 / SN0116 Main Screen

After you have successfully logged in, the SN0108 / SN0116 Main Screen appears:

The screenshot shows the ALTUSCN main screen. The top navigation bar includes icons for General, Network, Radius, ODBC, Date/Time, Firmware, and Logout. The left sidebar contains buttons for Status, Telnet (circled in red), Port Config, User Manager, Sessions Info, Sys Info, Log, and Help. The main content area displays the 'Serial Port Status' table.

Port Number	Port Name	Status	TCP Port	Tx Bytes	Rx Bytes	Online
COM1	Console	-	5001	4153407	0	Off
COM2	COM2	-	5002	0	0	Off
COM3	COM3	-	5003	0	0	Off
COM4	Mandrake Linux	-	5004	96	14941	On
COM5	COM5	-	5005	0	0	Off
COM6	COM6	-	5006	0	0	Off
COM7	COM7	-	5007	0	0	Off
COM8	COM8	-	5008	0	0	Off
COM9	COM9	-	5009	0	0	Off
COM10	COM10	-	5010	0	0	Off

The PN0108 is accessed through the Telnet function.

*(Continues on next page.)*

(Continued from previous page.)

1. Click the **Telnet** button to bring up the *Telnet Selection screen*:

Telnet Selection			
Select	Port Number	Port Name	TCP Port
<input type="radio"/>	Local	-	23
<input type="radio"/>	COM2	COM2	5002
<input type="radio"/>	COM3	COM3	5003
<input type="radio"/>	COM4	COM4	5004
<input type="radio"/>	COM5	COM5	5005
<input type="radio"/>	COM6	COM6	5006
<input type="radio"/>	COM7	COM7	5007
<input type="radio"/>	COM8	COM8	5008
<input type="radio"/>	COM9	COM9	5009
<input type="radio"/>	COM10	COM10	5010
<input type="radio"/>	COM11	COM11	5011
<input type="radio"/>	COM12	COM12	5012
<input type="radio"/>	COM13	COM13	5013
<input type="radio"/>	COM14	COM14	5014
<input type="radio"/>	COM15	COM15	5015
<input checked="" type="radio"/>	COM16	PN0108	5016

2. Select the port that the PN0108 is connected to.

---

**Note:** 1. You must have permission in order to access a port. Port permission is set by the SN0108 / SN0116 administrator.

2. If you want to view the port history, click the *View History* button. A screen showing the Telnet activity that took place on the device connected to the port appears. Click the browser's *Back* button to return to the Telnet page.
-

### 3. Click **Connect**.

The SN0108 / SN0116 opens a Telnet session and a screen similar to the one below appears:



```
Welcome to the ALTUSEN SN0108/SN0116
Copyright (c) 2004 ATEN International Co., Ltd.
Login: █
```

Connected to 10.0.0.163 5016 online

### 4. Log in with your SN0108 / SN0116 Username and Password. A telnet connection to the device is established:

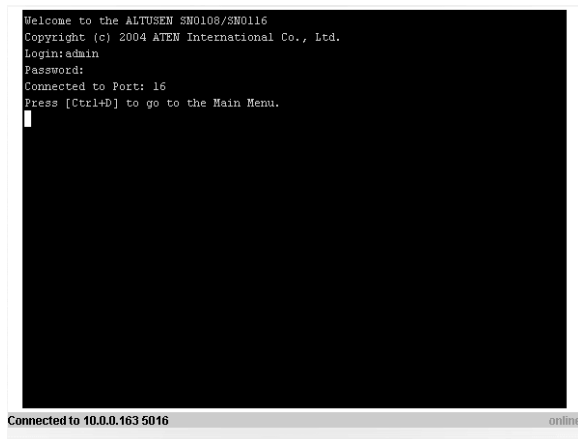

```
Welcome to the ALTUSEN SN0108/SN0116
Copyright (c) 2004 ATEN International Co., Ltd.
Login: admin
Password:
Connected to Port: 16
Press [Ctrl+D] to go to the Main Menu.
█
```

Connected to 10.0.0.163 5016 online

5. At the telnet prompt, key in: ??? to bring up the PN0108's menu:

```
*****
*****
**                               **
**          ALTUSEN -- PN0108 Power Manager          **
**                               **
*****
*****
1. PN0108RPSwitch
T. Set System Time
X. Exit
====>
```

Select **1** to switch to the PN0108 configuration and control functions. These are the text based equivalents of the browser configuration and control functions.

The descriptions and explanations for the Browser Operations discussed in Chapter 4, *Operation*, apply to the functions presented here, as well.

- 
- Note:**
1. As with the browser version, access to many of the submenus are restricted to the administrator or users with configuration permission. If you select a submenu that you are not authorized for, nothing will happen.
  2. Some of the submenus do not have an *Exit* choice. In these cases, you can return to the previous menu without making any changes by pressing **Enter**.
  3. You can bring up the Main Menu at any time during your session.
- 

When you have finished with your session, bring up the Main Menu and press **X** to log out.



---

## Local Console Operation

---

Local console operation can be accomplished through a VT100 terminal program, such as Hyperterminal, or with the Java application supplied on the software CD that came with this package.

### Hyperterminal

1. Use the PON cable that came with this package to connect a COM port on the PC to the PN0108's RS-232 port. (Refer back to the installation diagram on page 12, if necessary.)
2. On your PC, run the HyperTerminal program:

Start → Programs → Accessories → Communications →  
Hyper Terminal → Hypertrm.exe

The following dialog box appears:

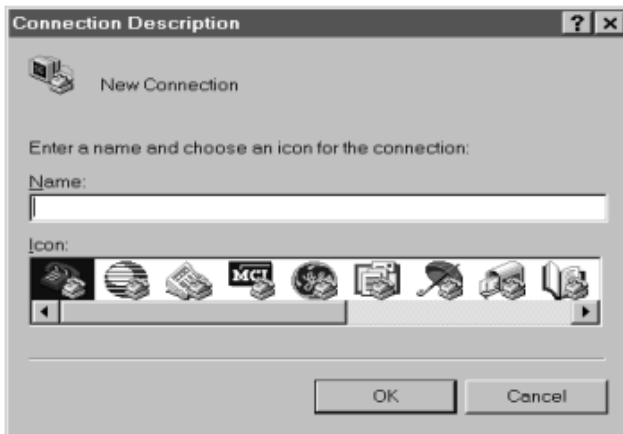

3. Key a name to describe the connection in the *Name* field (we used Com1Test); select an icon to represent the connection; then click **OK**.

---

**Note:** In the examples that follow we use COM1. If you use a different COM port, change the settings accordingly.

---

The following dialog box comes up:

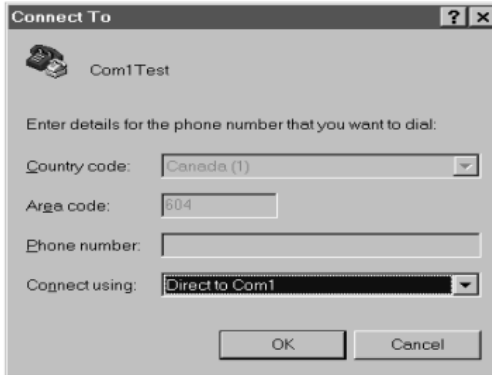

4. For the *Connect using:* field, select *Direct to COM1* (assuming you are using COM1 on your computer), then click **OK**. A *Port Setting* dialog box similar to the one below comes up:

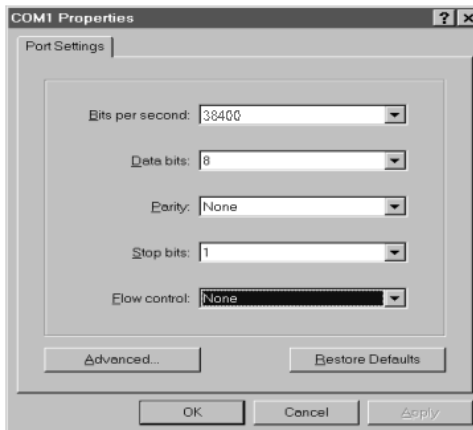

- The PN0108's serial port settings and the computer's COM port settings must be the same. Change the settings in your dialog box (if necessary), so that they match the PN0108's COM Port settings, then click **OK**.

---

**Note:** The PN0108's default settings are 38400 bps; 8 Data bits; No Parity; 1 Stop bit.

---

- When the HyperTerminal screen appears, open the File menu and select: Properties → Settings. The following dialog box displays:

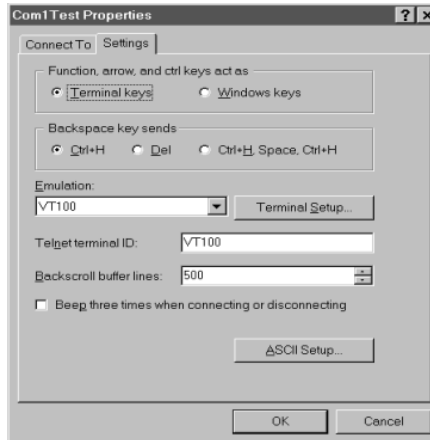

- Change the settings (if necessary), so that they match the settings shown in the diagram, then click **ASCII Setup...** The ASCII Setup dialog box comes up:



8. Change the settings (if necessary), so that they match the settings shown in the diagram, then click **OK**.
9. Close the HyperTerminal Window. When Windows asks if you want to disconnect, click **Yes**. When Windows asks if you want to save the session, click **Yes**.

This completes the HyperTerminal setup. For Windows NT, 2000, XP and Windows Server 2003 systems, a HyperTerminal icon that connects you to the PN0108 is created on the desktop. For Windows 98 and ME, you must access HyperTerminal from the Windows Start Menu.

### **Logging In:**

1. Double click the HyperTerminal icon on your desktop.
2. In the VT100 terminal window, key in:  
???  
A login prompt appears.
3. Key in your Username and Password to bring up the PN0108's main menu.

## **Java Application**

To use this application you must have the Java Runtime Environment (JRE) version 1.4.0 or higher installed on the computer that connects to the PN0108. If you don't already have the proper version of Java installed, go to the Java Sun website to download and install the latest JRE.

### **Windows Setup:**

This application makes use of several Java COM support files for Windows. The files can be found on the software CD that came with this package. They must be copied to the appropriate subdirectories under your JRE directory as follows:

1. Copy *comm.jar* to the JRE \lib\ext directory  
(e.g., C:\Program Files\Java\j2re1.4.2\_06\lib\ext)
2. Copy *win32com.dll* to the JRE\bin directory
3. Copy *javax.comm.properties* to the JRE\lib directory
4. Copy the Java Client program (*PowerMan.jar*) to a convenient location on your PC.

## Running the Application:

1. Use the PON cable that came with this package to connect a COM port on the PC to the PN0108's RS-232 port. (Refer back to the installation diagram on page 12, if necessary.)
2. Open a Command Line (DOS) prompt.
3. Change to the directory that PowerMan.jar is located in.
4. Issue the following command:

```
java -jar powerman.jar
```

The PN0108 Login dialog box appears:



The image shows a screenshot of a Java-based login dialog box. The title bar is black with the text 'PN0108 Login' in white. The main area has a light gray background. It contains two labels, 'Username:' and 'Password:', each followed by a white rectangular text input field. Below these fields are two gray buttons with white text: 'Login' and 'Reset'. At the bottom of the dialog, centered, is the ALTUSCN logo in a bold, black, sans-serif font, with the tagline 'Connect Without Limits' in a smaller font below it.

5. Log in with your username and password.

## The PN0108 Main Screen

After you have successfully logged in, the PN0108 Main Screen appears:

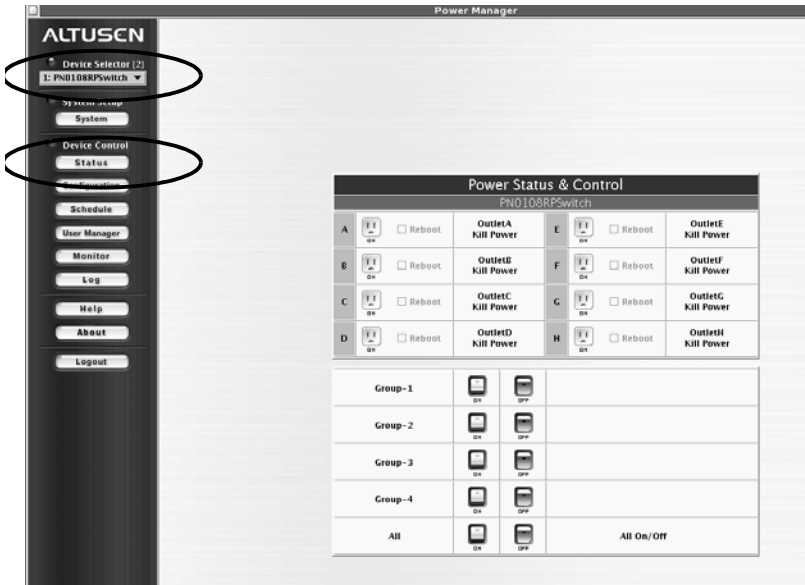

- ◆ When you first start up, the *Power Status & Control* screen of the First Station appears in the large central panel. The power management operations for the devices attached to the Station's outlets are made here.
- ◆ The bar along the left side is used to configure and control each of the PN0108 Stations on your installation. Regular users manage the devices they have permission for with the Device Selector and the Status button. The other buttons in this bar are for the administrator. Administrator functions are discussed in Chapter 5.

## Device Selector

Since up to 16 PN0108 Stations can be daisy chained, this panel lists each of the Stations on your installation. The number in brackets, to the right of the title, indicates the total number of stations on the installation.



The names of the Stations are listed in the list box below the title. To select a Station for power management, click on the arrow to drop the list down; then click to select the Station you want to work with. When you select a Station, its *Power Status & Control* screen displays in the large central panel.

- 
- Note:**
1. Each PN0108's *Station ID* is displayed in the Station ID LED on its front panel (see *Station ID LED*, page 6).
  2. The outlets in the *Power Status & Control* screen are only in effect for the Station that is selected in the Device Selector.
- 

## Device Control

With the exception of *Status*, the buttons in the *Device Control* panel are used by the Administrator to configure the power management options of the Station that is currently selected in the *Device Selector* panel. These functions are explained in Chapter 5, *Administration*.









Clicking the Status button brings up the Power Status screen for the currently selected device (see *Device Selector*, above). The Power Status Screen is discussed in the next section.





## The Power Status Screen

### ■ The Top Panel

Power Status & Control					
PN0108RPSwitch					
A	 <input type="checkbox"/> Reboot	OutletA Kill Power	E	 <input type="checkbox"/> Reboot	OutletE Kill Power
B	 <input type="checkbox"/> Reboot	OutletB Kill Power	F	 <input type="checkbox"/> Reboot	OutletF Kill Power
C	 <input type="checkbox"/> Reboot	OutletC Kill Power	G	 <input type="checkbox"/> Reboot	OutletG Kill Power
D	 <input type="checkbox"/> Reboot	OutletD Kill Power	H	 <input type="checkbox"/> Reboot	OutletH Kill Power

### Power Sockets:

The top panel of the Power Status screen is divided into eight subareas which correspond to the A- H outlets on the PN0108's rear panel.

Each subarea is composed of a *socket icon* that functions as the Power Button for its corresponding outlet, and an *information panel* to its right. Clicking the socket icon turns the power status of the computer attached to its outlet On or Off. The icon and the label under it inform you of the power status as shown in the following table:

Indication	Status
Steady Gray	Power to the outlet is OFF.
Flashing Gray	Power to the outlet is OFF but <i>Modem Ring Resume</i> has been specified as the remote power option (see <i>Modem Ring Resume*</i> , page 39, for details).
Flashing Yellow	A change in the outlet's power status is pending. See <i>Modem Ring Resume*</i> and <i>System after AC back*</i> , page 39, for details.
Steady Amber	Power to the outlet is ON.
Flashing Lightbulb	Indicates that the outlet is either experiencing an overcurrent situation, or the relay has failed. Click the icon to recover. If the port recovers successfully, it returns to the status it was at before it failed, and the icon changes to reflect the recovered status. If the port cannot recover, contact Altusen technical support.

If *Reboot* is enabled (by putting a check in the checkbox), the computer attached to the Outlet's corresponding port will reboot instead of shutting off when the Power Button is clicked to turn the outlet off. This selection is disabled (grayed out) if the Outlet isn't configured for a Safe Shutdown capable option. See *Configuration*, page 38, for further details.

---











**Note:** This function only works with computers capable of a Safe Power Shutdown. See step 3 of *Single Stage Installation*, page 11, and *Overview*, page 47.

---

### **The Information Panel:**

The information panel, just to the right of the socket icon panel, shows the Outlet's name and currently selected power option. These parameters are set by the Administrator with the *Configuration* function (see *Configuration*, page 38, for details).

## ■ The Bottom Panel

Group-1			
Group-2			
Group-3			
Group-4			
All			All On/Off

The bottom panel allows you to control the power status of your outlet groups.

Outlets can be placed into groups so that Power On/Off actions can be carried out on the entire outlet group at the same time, rather than performing the same action on each outlet individually. Clicking the group's *On* or *Off* Power Button (the rocker switch icons) performs the power action that was set by the administrator for each of the outlets.

- 
- Note:**
1. Users must have permission to operate all the ports in a group in order to use this function. If a user doesn't have permission to operate any port in the group, clicking the Power Button has no effect.
  2. If some ports in a group are ON and some are OFF, and you click the OFF button, the ports that are ON turn OFF. The ports that are OFF remain OFF. Likewise, if you click the ON button, the ports that are OFF turn ON, while the ports that are ON remain ON.
- 

Details about creating and configuring power outlet groups are described in the *Configuration* section of the Administration chapter (see page 38).

This Page Intentionally Left Blank

# Chapter 5 Administration

## System Setup

---

Clicking the *System* button brings up the System dialog box:

System	
<b>Administrator</b>	
User Name:	administrator
Password:	*****
Confirm Password:	*****
<b>Connection Control</b>	
Session Timeout:	3 minute(s)
	<input checked="" type="checkbox"/> No timeout on monitoring
Save      Restore	

### Administrator

This section sets the administrator's login name and password. For security purposes, we strongly recommend you change the default value to something unique. The minimum number of alphanumeric characters for both entries is 4; the maximum number is 15.

### Connection Control

- ◆ *Session Timeout* sets a timeout value. If there is no input from the logged in operator for the amount of time set with this function, the operator is automatically logged out and the session is terminated. Valid settings are from 2 ~ 99 minutes. The default is 3 minutes.
- ◆ If *No timeout on monitoring* is enabled, the system will not time out when you are using the Monitor function to view the power status of your installation (see *Monitor*, page 44, details).

## Device Control

The *Device Control* panel allows the PN0108 administrator to configure the PN0108's power management parameters. The functions provided by each of the buttons are explained in the sections that follow.

**Note:** On multi-station installations, you must perform a separate set up for each of the Stations.

## Configuration

Clicking the *Configuration* button brings up the Configuration screen:

Configuration							
Station: PN0108RPSwitch F/W Ver: 1.6.152							
Station Name		PN0108RPSwitch					
Outlet	Name	Modem Ring Resume	System After AC	Kill the Power	Confirmati... Required	Power On Delay	Power Off Delay
A	OutletA	<input type="radio"/>	<input type="radio"/>	<input checked="" type="radio"/>	<input type="checkbox"/>	0 sec	0 sec
B	OutletB	<input type="radio"/>	<input type="radio"/>	<input checked="" type="radio"/>	<input type="checkbox"/>	0 sec	0 sec
C	OutletC	<input type="radio"/>	<input type="radio"/>	<input checked="" type="radio"/>	<input type="checkbox"/>	0 sec	0 sec
D	OutletD	<input type="radio"/>	<input type="radio"/>	<input checked="" type="radio"/>	<input type="checkbox"/>	0 sec	0 sec
E	OutletE	<input type="radio"/>	<input type="radio"/>	<input checked="" type="radio"/>	<input type="checkbox"/>	0 sec	0 sec
F	OutletF	<input type="radio"/>	<input type="radio"/>	<input checked="" type="radio"/>	<input type="checkbox"/>	0 sec	0 sec
G	OutletG	<input type="radio"/>	<input type="radio"/>	<input checked="" type="radio"/>	<input type="checkbox"/>	0 sec	0 sec
H	OutletH	<input type="radio"/>	<input type="radio"/>	<input checked="" type="radio"/>	<input type="checkbox"/>	0 sec	0 sec

Outlet Groups									
Group	Name	Outlets in Each Group							
Group-1	Group-1	<input type="checkbox"/> A	<input type="checkbox"/> B	<input type="checkbox"/> C	<input type="checkbox"/> D	<input type="checkbox"/> E	<input type="checkbox"/> F	<input type="checkbox"/> G	<input type="checkbox"/> H
Group-2	Group-2	<input type="checkbox"/> A	<input type="checkbox"/> B	<input type="checkbox"/> C	<input type="checkbox"/> D	<input type="checkbox"/> E	<input type="checkbox"/> F	<input type="checkbox"/> G	<input type="checkbox"/> H
Group-3	Group-3	<input type="checkbox"/> A	<input type="checkbox"/> B	<input type="checkbox"/> C	<input type="checkbox"/> D	<input type="checkbox"/> E	<input type="checkbox"/> F	<input type="checkbox"/> G	<input type="checkbox"/> H
Group-4	Group-4	<input type="checkbox"/> A	<input type="checkbox"/> B	<input type="checkbox"/> C	<input type="checkbox"/> D	<input type="checkbox"/> E	<input type="checkbox"/> F	<input type="checkbox"/> G	<input type="checkbox"/> H

## Outlet Configuration:

The top panel allows you to set up a power management configuration for each outlet. These settings determine what takes place when you click the Power Button On or Off. The meanings of the field headings are given in the following table:

Heading	Meaning
Station Name	To make things more convenient on a multi-station installation, each station can be given a distinctive name. To name a station key in the name of your choice - up to 15 letters and numbers.
Outlet Name	Each outlet can be given a distinctive name. The maximum number of characters is 15.
Modem Ring Resume*	<p>This is a Safe Shutdown and Reboot option (see <i>Overview</i>, page 47). If this option is selected, when the Outlet's Power Button is clicked OFF, the PN0108 waits for the amount time set in the <i>Power Off Delay</i> dialog box (see below), and then performs a Safe Shutdown on the computer attached to its Outlet. When the Power Button is clicked ON, the PN0108 waits for the amount time set in the <i>Power On Delay</i> field (see below), and then restarts the computer. The front panel LEDs flash while the action is pending.</p> <p><b>Note:</b> With this option, although the computer has been turned off, it is still receiving power through the outlet. Therefore, the computer can be locally (physically) turned on or off - in which case the computer's status may not correspond with the Outlet Status display. The gray "socket" icon flashes (instead of remains steady) to remind you of this. To make sure that the computer is in sync with the display, click the power On/Off/On (or Off/On/Off) when making a power status change.</p>
System after AC back*	<p>This is a Safe Shutdown option (see <i>Overview</i>, page 47). If this option is selected, when the Outlet's Power Button is clicked OFF, the PN0108 waits for the amount time set in the <i>Power Off Delay</i> dialog box (see below), and then performs a Safe Shutdown on the computer attached to its Outlet.</p> <p>When the Power Button is clicked ON the PN0108 waits for the amount time set in the <i>Power On Delay</i> field (see below), and then restarts the computer.</p> <p><b>Note:</b> With this option power through the Outlet is cut off. Although it was safely shutdown, the computer does not receive any power through the outlet.</p>

(Continued from previous page.)

Heading	Meaning
Kill the Power	If this option is selected, the PN0108 waits for the amount time set in the <i>Power Off Delay</i> field (see below), and then turns the Outlet's power OFF when its Power Button is clicked to turn off the power. Turning the power off performs a cold (non-safe) shutdown. Selecting this function disables the Reboot checkbox on the main screen.
Confirmation Required	If this option is enabled (there is a check in the checkbox), a dialog box comes up asking you to confirm the operation before it is performed. If it is disabled (there is no check in the checkbox), the operation is performed without confirmation.
Power On Delay	Sets the amount of time the PN0108 waits after the Power Button is clicked before it turns on the computer attached to the corresponding outlet.
Power Off Delay	Sets the amount of time the PN0108 waits after the Power Button is clicked before it shuts down the computer attached to the corresponding outlet.  For the <i>System after AC Back</i> option, after the delay time expires, the PN0108 waits another fifteen seconds, then shuts the computer down.  The minimum (and default) delay time is 15 seconds. The maximum delay time is 999 seconds.

To save your settings, Click **Save**. To exit without saving your changes, use your browser's *Back* function to go back to the Main web page, or click another button on the page to go to a different function.

---

\* This function only works with computers capable of a Safe Power Shutdown. See step 3 of *Single Stage Installation*, page 11, and Chapter 6, *Safe Shutdown and Reboot*.

---

## Outlet Groups:

Outlet groups allow power control actions to be carried out on the entire group at the same time, rather than repeatedly performing the same action on each individual outlet. You can have four outlet groups per station, and each group can be given a distinctive name. The maximum number of characters for the name is 15.

The bottom Configuration panel lets you select the outlets that you want to put together as an outlet group.



Outlet Groups		
Group	Name	Outlets in Each Group
Group-1	<input type="text" value="Group-1"/>	<input type="checkbox"/> A <input type="checkbox"/> B <input type="checkbox"/> C <input type="checkbox"/> D <input type="checkbox"/> E <input type="checkbox"/> F <input type="checkbox"/> G <input type="checkbox"/> H
Group-2	<input type="text" value="Group-2"/>	<input type="checkbox"/> A <input type="checkbox"/> B <input type="checkbox"/> C <input type="checkbox"/> D <input type="checkbox"/> E <input type="checkbox"/> F <input type="checkbox"/> G <input type="checkbox"/> H
Group-3	<input type="text" value="Group-3"/>	<input type="checkbox"/> A <input type="checkbox"/> B <input type="checkbox"/> C <input type="checkbox"/> D <input type="checkbox"/> E <input type="checkbox"/> F <input type="checkbox"/> G <input type="checkbox"/> H
Group-4	<input type="text" value="Group-4"/>	<input type="checkbox"/> A <input type="checkbox"/> B <input type="checkbox"/> C <input type="checkbox"/> D <input type="checkbox"/> E <input type="checkbox"/> F <input type="checkbox"/> G <input type="checkbox"/> H
<input type="button" value="Save"/>		

To set up an Outlet Group, give it a Name, then put a check in the boxes of the outlets you want in the group.

---

**Note:** Outlets can belong to more than one group. For example, Group 1 can consist of outlets A, B, C, and D, while Group 2 consists of outlets B, D, E, G, and H.

---

## **Finishing Up**

- ◆ When you have finished making your settings selections, click **Save** to save your changes.
- ◆ To leave this screen after you have saved your changes, click on another button in the Device Control List.
- ◆ To abandon any changes and keep the original settings, click on another button in the Device Control List without saving this screen.

## Schedule

Schedule			
Station: PN0108RPSwitch		OutletA:OutletA	
<input type="button" value="OutletA"/>		<input type="button" value="OutletB"/>	
<input type="button" value="OutletC"/>		<input type="button" value="OutletD"/>	
<input type="button" value="OutletE"/>		<input type="button" value="OutletF"/>	
<input type="button" value="OutletG"/>		<input type="button" value="OutletH"/>	
Date	Enable/Disable	Shutdown Time (HH:MM)	Restart Time (HH:MM)
MON	<input type="checkbox"/>	0 : 0	0 : 0
TUE	<input type="checkbox"/>	0 : 0	0 : 0
WED	<input type="checkbox"/>	0 : 0	0 : 0
THU	<input checked="" type="checkbox"/>	17 : 15	17 : 16
FRI	<input type="checkbox"/>	0 : 0	0 : 0
SAT	<input type="checkbox"/>	0 : 0	0 : 0
SUN	<input type="checkbox"/>	0 : 0	0 : 0
<input type="button" value="Save"/>			

The *Schedule* dialog box allows you to set up a scheduled Power On/Off configuration for each of the outlets. To do so:

1. Select your outlet from the buttons in the upper panel.
2. Put a check in the *Enable/Disable* checkbox to enable scheduling for the desired day.
3. Key in the Shutdown and Restart times.
4. Click **Save**.
5. Repeat for additional outlets.

## Finishing Up

- ◆ To leave this screen after you have saved your changes, click on another button in the Device Control List.
- ◆ To abandon any changes and keep the original settings, click on another button in the Device Control List without saving this screen.

## User Management

User Management									
Station: PN0108RPSwitch									
Username	Password	A	B	C	D	E	F	G	H
<input type="text" value="rjf111"/>	<input type="password" value="*****"/>	<input checked="" type="checkbox"/>	<input checked="" type="checkbox"/>	<input checked="" type="checkbox"/>	<input checked="" type="checkbox"/>	<input checked="" type="checkbox"/>	<input checked="" type="checkbox"/>	<input checked="" type="checkbox"/>	<input checked="" type="checkbox"/>
<input type="text" value="alice"/>	<input type="password" value="*****"/>	<input checked="" type="checkbox"/>	<input type="checkbox"/>	<input checked="" type="checkbox"/>	<input checked="" type="checkbox"/>	<input type="checkbox"/>	<input checked="" type="checkbox"/>	<input type="checkbox"/>	<input checked="" type="checkbox"/>
<input type="text" value="sandy"/>	<input type="password" value="*****"/>	<input checked="" type="checkbox"/>	<input checked="" type="checkbox"/>	<input checked="" type="checkbox"/>	<input type="checkbox"/>	<input checked="" type="checkbox"/>	<input type="checkbox"/>	<input checked="" type="checkbox"/>	<input type="checkbox"/>
<input type="text" value="archibald"/>	<input type="password" value="*****"/>	<input checked="" type="checkbox"/>	<input type="checkbox"/>	<input type="checkbox"/>	<input type="checkbox"/>	<input checked="" type="checkbox"/>	<input type="checkbox"/>	<input type="checkbox"/>	<input checked="" type="checkbox"/>
<input type="button" value="Save"/>									

















The *User Manager* dialog box allows the Administrator to set up Usernames and Passwords that operators must provide in order to log into the PN0108. The minimum number of characters for each field is 4; the maximum is 15.

The Administrator also uses this dialog box to set the outlets that a User can control. A check mark in the box under the Outlet allows a User to control that Outlet.

### Finishing Up

- ◆ When you have finished making your settings selections, click **Save** to save your changes.
- ◆ To leave this screen after you have saved your changes, click on another button in the Device Control List.
- ◆ To abandon any changes and keep the original settings, click on another button in the Device Control List without saving this screen.

## Monitor

Device Monitor									
ID	Name	Outlet Status							
		A	B	C	D	E	F	G	H
01	PN0108RPSwitch								
02	PN0108RPSwitch								

The *Device Monitor* displays the power status of your entire installation. You can see at a glance what the On/Off status of each outlet is.

---

**Note:** If the *No timeout on monitoring* function is enabled in the *System* dialog box (see *System Setup*, page 37), the PN0108 will not time out when this function is being used.

---

To leave this screen, click on another button in the Device Control List.

## Log

Event Log	
Station: PN0108RPSwitch	
<input checked="" type="radio"/> <b>Today</b> <input type="radio"/> <b>All</b> <input type="radio"/> <b>Selected</b>	
<b>From: YYYY/MM/DD</b>	<input type="text" value="2005/1/7"/>
<b>To: YYYY/MM/DD</b>	<input type="text" value="2005/1/7"/>
<input type="button" value="OK"/>	

The PN0108 maintains a log file of the last 100 events that took place on it. This dialog box allows you to select the range of events you wish to view:

- ♦ Choose **Today** then click **OK** to see a listing of only today's events.
- ♦ Choose **All** then click **OK** to see a listing of events for the entire log file.
- ♦ Choose **Selected**; key in the desired range of dates in the *From* and *To* fields; then click **OK** to see a listing of events for a specific time period.

Once you make a choice and click OK an Event Log List, similar to the one below, appears:

Event Log List				
Station: PN0108RPSwitch				
No.	Date/Time	User	Message	
66.	2005/01/10 16:06:07	administ	Turned off Group All (Outlet: A)	
67.	2005/01/10 16:06:07	administ	Turned off Group All (Outlet: B)	
68.	2005/01/10 16:06:07	administ	Turned off Group All (Outlet: C)	
69.	2005/01/10 16:06:07	administ	Turned off Group All (Outlet: D)	
70.	2005/01/10 16:06:07	administ	Turned off Group All (Outlet: E)	
71.	2005/01/10 16:06:07	administ	Turned off Group All (Outlet: F)	
72.	2005/01/10 16:06:07	administ	Turned off Group All (Outlet: G)	
73.	2005/01/10 16:06:07	administ	Turned off Group All (Outlet: H)	
74.	2005/01/10 16:08:35	administ	Logged in	
75.	2005/01/10 16:12:01	administ	Logged in	
76.	2005/01/10 16:19:48	administ	Logged in	
77.	2005/01/10 16:22:07	administ	Logged in	
78.	2005/01/10 16:24:44	administ	Logged in	
79.	2005/01/10 16:27:47	administ	Logged out	
80.	2005/01/10 16:37:42	administ	Logged in	
81.	2005/01/10 16:41:41	administ	Logged out	
82.	2005/01/10 19:28:53	administ	Logged in	
83.	2005/01/10 19:29:12	administ	Logged out	
84.	2005/01/11 14:38:28	administ	Logged in	
85.	2005/01/11 14:38:34	administ	Turned on (Outlet: A)	
86.	2005/01/11 14:38:35	administ	Turned on (Outlet: B)	

When you have finished viewing the event list:

- ◆ If you want to return to the Event Log dialog box, click **Back**.
- ◆ If you want to erase the contents of the entire log file, click **Clear All**.
- ◆ To exit, select a different Device Control function.

# Chapter 6

## Safe Shutdown and Reboot

### Overview

---

The PN0108's *Safe Shutdown and Reboot* functions are available for systems running Windows. Safe shutdown and reboot lets you safely close a system down and reboot it without involving the danger to the file systems that simply killing the power supply does. In order to use this function:

- ◆ You must connect a Safe Shutdown Cable from the PN0108 to the computer (see *Single Stage Installation*, page 11).
- ◆ You must enable either *Modem Ring Resume* or *System after AC back* (but not both) in the computer BIOS' Power Management settings.
- ◆ The settings you select in the BIOS must match the settings you made in the Outlet *Configuration* dialog box (see *Configuration*, page 38).
- ◆ If you choose *Modem Ring Resume*: 1) your system BIOS must support this function; and 2) check your computer manual to be sure the system supports the COM port External Modem Wakeup function, since some BIOS versions only support this function with an internal PCI card modem.
- ◆ If your BIOS doesn't support the COM port External Modem Wakeup function, you cannot use *Modem Ring Resume*.
- ◆ The wording for the *Modem Ring Resume* function may vary somewhat from system to system. For example:
  - ◆ Wake On LAN / Ring Connector
  - ◆ Modem Ring On
  - ◆ Power On By External ModemIn the BIOS settings, choose **Enabled**.
- ◆ The wording for the *System after AC back* function may vary somewhat from system to system. For example:
  - ◆ AC Loss Auto Restart
  - ◆ Restore on AC Power LossIn the BIOS settings, choose **Power On (Full On)**.
- ◆ NT systems must use the *System after AC back* function.

## Automated Setup

---

There are two methods to set up safe shutdown and rebooting: Automated, and Manual. This section discusses an automated setup. Manual setup, is discussed on page 50. Automated setup is made possible with the use of the *Power Monitor* utility supplied on the software CD that came with this package.

---



**Note:** Power Monitor only works with Windows systems.

---

Power Monitor watches the computer's power status via the UPS signal. If the UPS signals a power failure and a low battery condition, a dialog box pops up to inform you that the utility will perform a safe shutdown in a few seconds.

### Installation

To install the Power Monitor, simply execute the self extracting setup program (PMonitorSetup.exe). A copy of PMonitor.exe is placed in the Windows Startup folder so that it executes each time the system is booted.

When monitoring is in effect, a monitoring icon in the form of lightning bolt (  ) is placed in the Windows taskbar to indicate so. When monitoring is temporarily disabled, a canceled lightning bolt icon (  ) is displayed.

- ◆ You can switch between enabled and disabled by right clicking the icon and selecting *Start Monitor* or *Stop Monitor* from the pop up context menu.
- ◆ You can exit the program by right clicking on the icon and selecting *Exit* from the pop up context menu.



By default, PMonitor monitors the COM1 port. If the utility displays an error message stating that it is unable to open the COM1 port, it means that the port is already being used by another utility.

You can either stop the other utility, and try again, or use a different COM port for the PMonitor program. If you choose to use a different COM port:

1. Stop the PMonitor program
2. Connect your safe shutdown cable to a different COM port
3. Right click on the *Monitoring Disabled* icon, and select *Options* from the context menu that appears. A dialog box, similar to the one below appears:

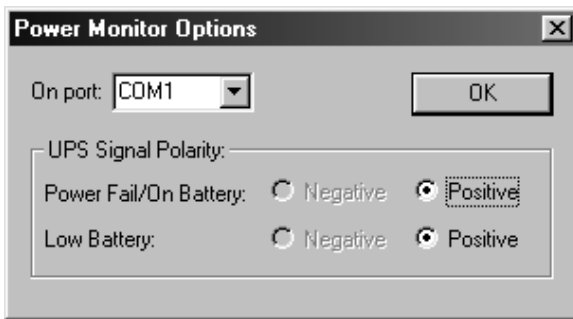

4. Open the list of COM ports, and select the COM port that the safe shutdown cable is connected to.

---

**Note:** Only changes to the COM port selection can be made in this dialog box. Since the utility only monitors the Positive UPS signals, the other settings are fixed.

---

## **Uninstalling**

To uninstall the utility:

1. Exit the Power Monitor program.
2. Open the Windows Start menu.
3. Choose Programs → Power Monitor → Uninstall Power Monitor.

## Manual Setup

---

Windows NT, 2000, XP, and Server 2003 can be manually configured for safe shutdown and rebooting instead of using the *Power Monitor* utility. The following sections explain the procedures involved.

### **Windows 2000 / XP / Server 2003:**

To set up Windows 2000, XP, or Server 2003 for safe shutdown and rebooting, do the following:

1. Go to the Control Panel; open *Power Options*; open the *UPS* page; in the Details panel, click **Select**. A dialog box similar to the one below appears:

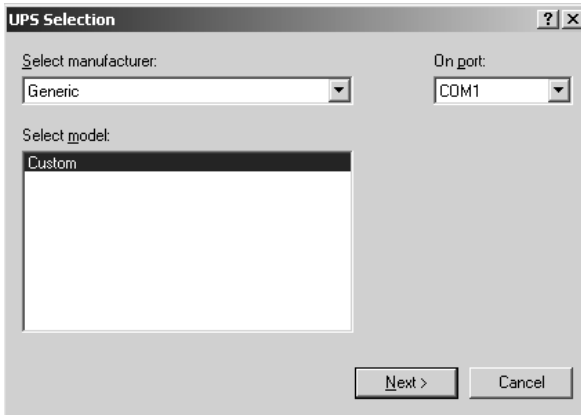

- a) For the COM port entry, select the COM port on the computer that the Safe Shutdown Cable is plugged into.
- b) Match the other options to the values shown in the figure above.

- Click **Next**. A dialog box similar to the one below appears:

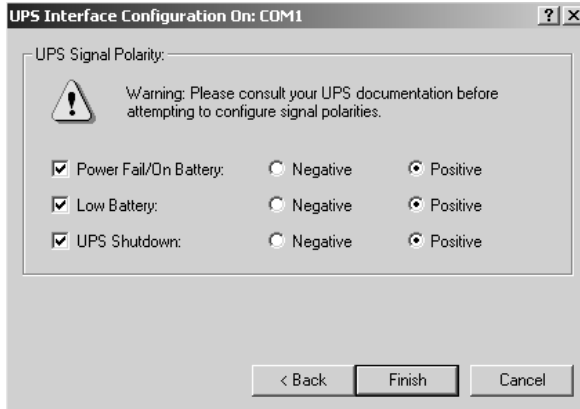

Select the options in the dialog box so that they match the settings shown in the figure above.

- Click **Finish**; click **OK**.

To check that the setup is working:

- Navigate through the following folders: Control Panel → Administrative Tools → Services.
- In Services, scroll down until you see the *Uninterruptible Power Supply* entry with *Started* for its status, as shown in the figure below:

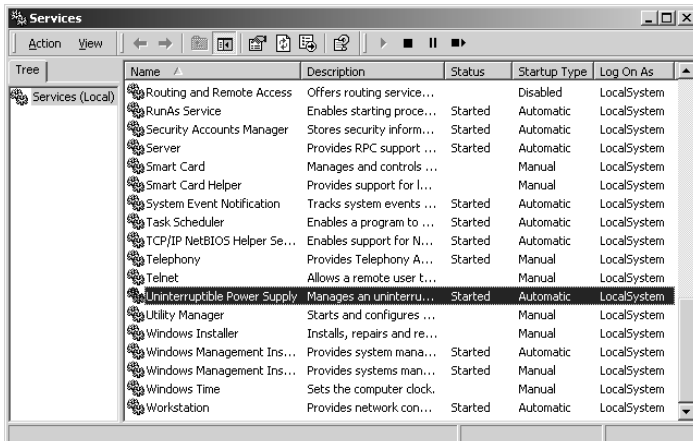

**NT:**

1. Go to the Control Panel; open the *UPS* entry. A dialog box similar to the one below appears:

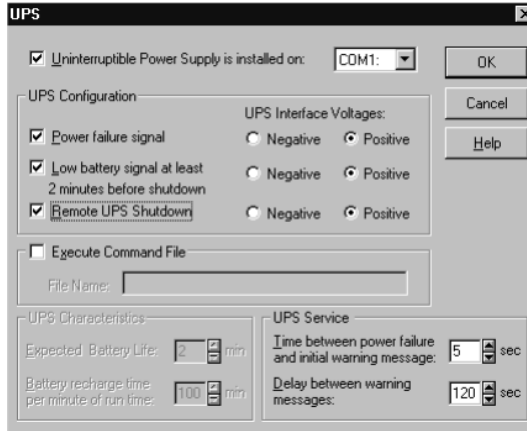

- a) For the COM port entry, select the COM port on the computer that the Safe Shutdown Cable is plugged into.
- b) Match the other options to the values shown in the figure above.

2. Click **OK** to finish

To check that the setup is working:

1. Navigate through the following folders: Control Panel → Administrative Tools → Services.
2. In Services, scroll down until you see the *Uninterruptible Power Supply* entry with *Started* for its status, as shown in the figure below:

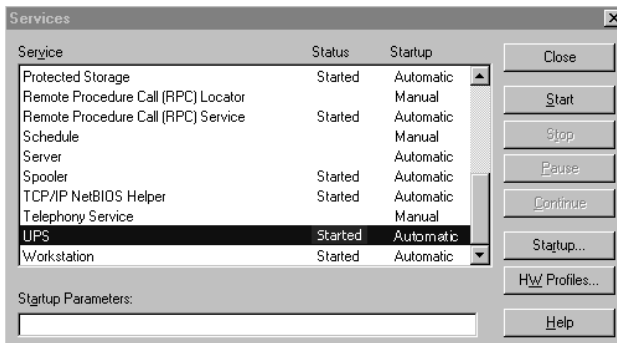

# Chapter 7

## Upgrading The Firmware

The Windows-based Firmware Upgrade Utility (FWUpgrade.exe) provides a smooth, automated process for upgrading the PN0108's firmware. The Utility comes as part of a Firmware Upgrade Package that is specific for each device. New firmware upgrade packages are posted on our web site as they become available. Check the Altusen web site regularly to find the latest packages:

---

**Note:** If the PN0108 is connected to a PN9108, it is not necessary to upgrade the firmware directly, since it will automatically receive a firmware upgrade when the PN9108 is upgraded.

---

### Preparation

---

1. Go to our Internet support site and choose the model name that relates to your device (PN0108) to get a list of available Firmware Upgrade Packages.
2. Choose the Firmware Upgrade Package you want to install (usually the most recent), and download it to your computer.
3. Use the PON Cable provided with this unit, to connect a COM port on your computer to the PN0108's PON In port.

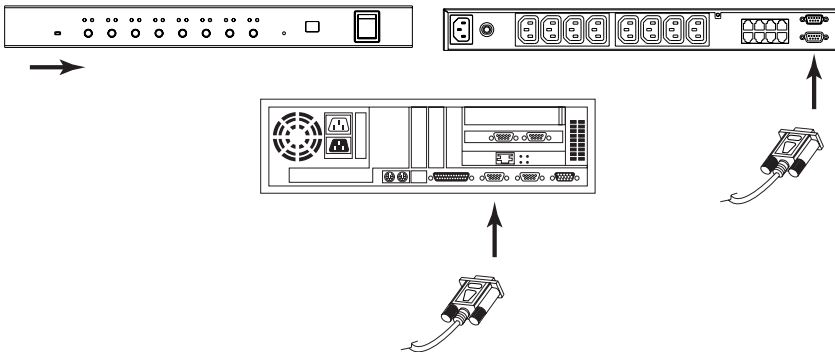

4. Slide the First Station's Firmware Upgrade switch to the RECOVER position.
  - a) Its Port LEDs blink at half second intervals.
  - b) The STATION ID LEDs display the word, **UP**, and blink at half second intervals.
5. Slide the First Station's Firmware Upgrade switch back to the NORMAL position.
  - a) The First Station's STATION ID LEDs display the Station ID's of all the daisy chained stations in sequence (01, 02, 03...)
  - b) After the First Station has run through the sequence, its STATION ID LEDs display the word, **UP**, and blink at 1 second intervals. Its Port LEDs also blink at 1 second intervals.
  - c) Next, all the Port LEDs on the daisy chained stations blink at 1 second intervals, and their STATION ID LEDs display the word, **UP**, which also blinks at 1 second intervals.
  - d) Finally, all STATION ID LEDs return to displaying their Station ID numbers, indicating that they are ready for the firmware upgrade procedure, and you may start the upgrade.

- 
- Note:**
1. Each station is upgraded in turn. The STATION ID LEDs of the station currently receiving the upgrade display the word, **UP**, and blink at 1 second intervals. All other STATION ID LEDs display their station numbers, and also blink at 1 second intervals.
  2. All stations restart automatically after they have been successfully upgraded.
-

## Starting the Upgrade

To upgrade your firmware:

1. Run the downloaded Firmware Upgrade Package file - either by double clicking the file icon, or by opening a command line and entering the full path to it.

The Firmware Upgrade Utility *Welcome* screen appears:

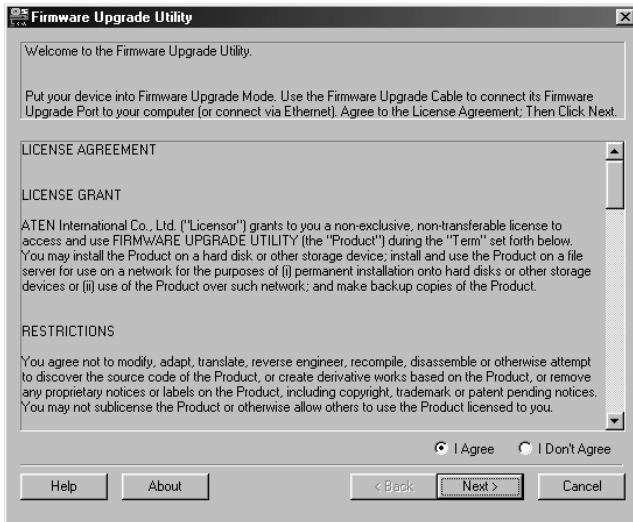

2. Read and *Agree* to the License Agreement (enable the I Agree radio button).

3. Click Next to continue. The Firmware Upgrade Utility main screen appears.

The Utility inspects your installation. All the devices capable of being upgraded by the package are listed in the *Device List* panel.

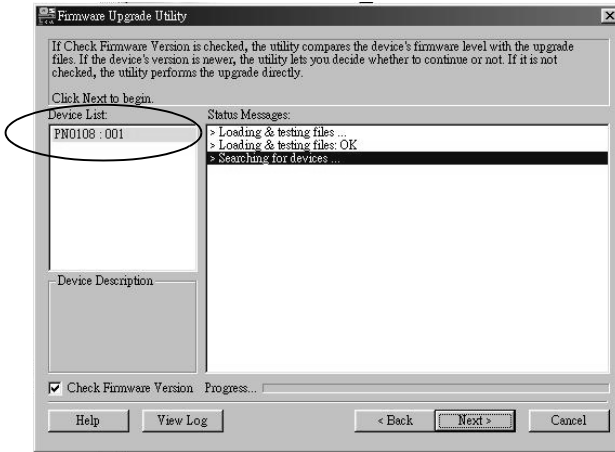

A blue background behind the device name indicates that it is ready to be upgraded.

4. After you have made your device selection(s), Click **Next** to perform the upgrade.

If you enabled *Check Firmware Version*, the Utility compares the device's firmware level with that of the upgrade files. If it finds that the device's version is higher than the upgrade version, it brings up a dialog box informing you of the situation and gives you the option to Continue or Cancel.

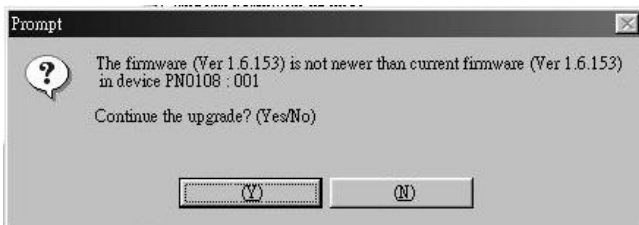



If you didn't enable *Check Firmware Version*, the Utility installs the upgrade files without checking whether they are a higher level, or not.

As the Upgrade proceeds status messages appear in the Status Messages panel, and the progress toward completion is shown on the *Progress* bar.

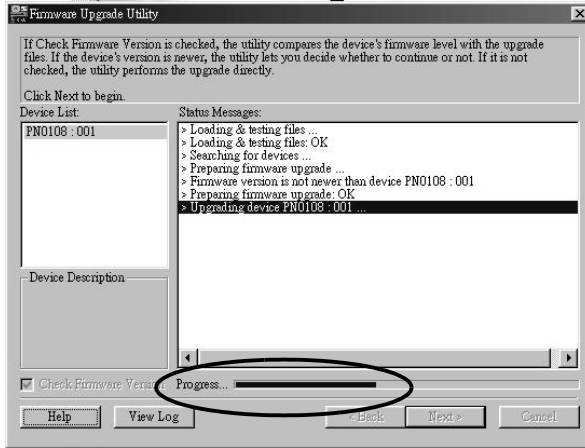

## Upgrade Succeeded

---

After the upgrade has completed, a screen appears to inform you that the procedure was successful:

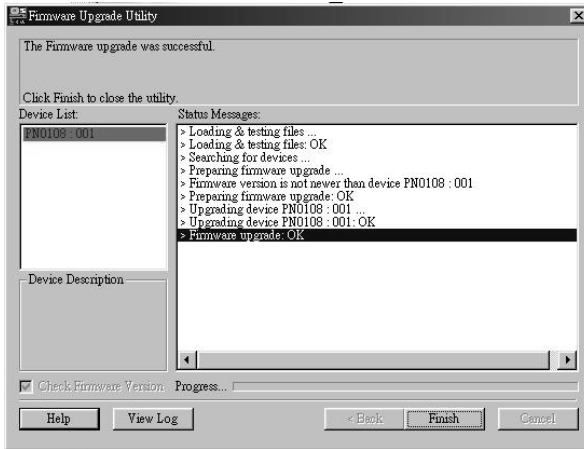

Click **Finish** to close the Firmware Upgrade Utility.

---

**Note:** On a daisy chained installation, all stations restart automatically after they have been successfully upgraded.

---

## Upgrade Failed

If the upgrade failed to complete successfully a dialog box appears asking if you want to retry. Click **Yes** to retry. If you Click **No**, the *Upgrade Failed* screen appears:

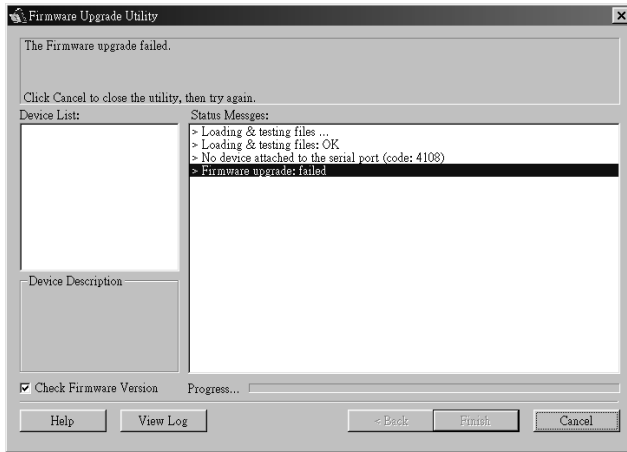

Click **Cancel** to close the Firmware Upgrade Utility. See the next section, *Firmware Upgrade Recovery*, for how to proceed.

## **Firmware Upgrade Recovery**

---

### **Single Station Recovery**

To perform a firmware upgrade recovery, do the following:

1. Power the PN0108 OFF.
2. Slide the Firmware Upgrade switch to the RECOVER position.
3. Power the PN0108 back ON.
4. Repeat the upgrade procedure from the beginning.
5. After the upgrade, power the PN0108 OFF.
6. Slide the Firmware Upgrade switch to the NORMAL position.
7. Power the PN0108 back ON.

### **Daisy Chained Station Recovery**

If any of the Stations on a daisy chained installation fails to complete the upgrade procedure successfully:

1. Disconnect it from the chain.
2. Connect your computer to its PON In port (with the PON Cable).
3. Perform the upgrade recovery procedure on it as for a single station recovery.

After the upgrade completes, connect it back into the chain.

## Troubleshooting

---

### Problem 1:

On a safe shutdown and reboot operation, when rebooting, the computer stops at the logon screen and waits for a Username and Password instead of automatically logging on.

### Solution:

Configure the Autologon function for the computer as follows:

1. For Win NT, run *regedit.exe*; for Win 2000 or XP, run *regedt32*
2. Select the following:  
HKEY\_LOCAL\_MACHINE\SOFTWARE\Microsoft\Windows NT\Current Version\Winlogon
3. Under the *Edit* menu, select **Add Value**.
4. Add the variables and values as shown in the table below:

Name	Value
DefaultDomainName	[domain name for this computer]
DefaultUserName	[user name for this computer]
DefaultPassword	[user password for this computer]
AutoAdminLogon	1

---

**Note:** Remove the brackets and replace the text inside the brackets with suitable values for yourself on this computer.

---

5. Close the Registry Editor.

---

**Note:** Make sure you have a real password (not blank) configured for logging on to your system.

---

**Problem 2:**

The computer has an older mainboard that doesn't support APM in the BIOS. What can I do to get Safe Shutdown and Reboot working?

**Solution:**

If you are running Windows 2000, XP, or Server 2003, you can do the following:

1. Open Control Panel → Power Options.
2. Open Properties → APM.
3. Enable Advanced Power Management support.

**Problem 3:**

When I log in, the browser generates a *CA Root certificate is not trusted*, or a *Certificate Error* response.

**Solution:**

The certificate's name is not found on Microsoft's list of Trusted Authorities. The certificate can be trusted, however. See *Trusted Certificates*, page 64, for details.

## Supported Devices

---

The following is a list of supported devices that can be used with the PN0108.

- ◆ CN6000
- ◆ KN2108 / KN2116
- ◆ KN9116
- ◆ PN9108
- ◆ SN0108 / SN0116

## Administrator Login Failure

If you are unable to perform an Administrator login (because the Username and Password information has become corrupted, or you have forgotten it, for example), you can clear the login information with the following procedure:

1. Power off the PN0108 and remove its cover.
2. Short the jumper labeled J4.

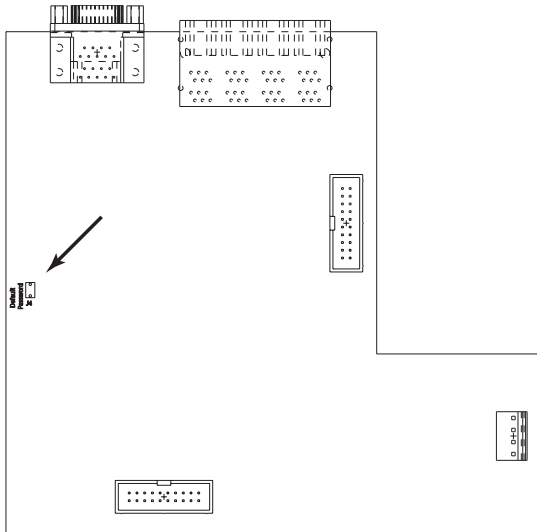

3. Power on the switch.
4. Wait 5 seconds, then power off the switch.
5. Remove the jumper cap from J4.
6. Close the housing and start the PN0108 back up.

After you start back up, you can use the default Username and Password to log in (see page 63).

## Trusted Certificates

---

### Overview

When you try to log in to the device from your browser, a Security Alert message appears to inform you that the device's certificate is not trusted, and asks if you want to proceed.

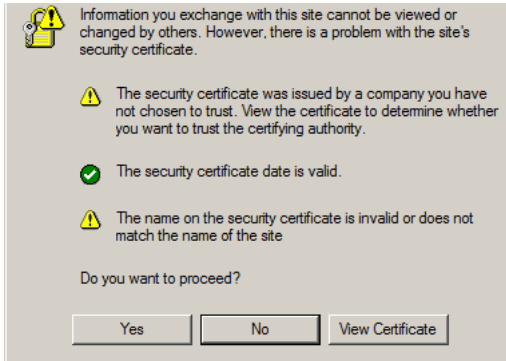

The certificate can be trusted, but the alert is triggered because the certificate's name is not found on Microsoft list of Trusted Authorities. You have two options: 1) you can ignore the warning and click **Yes** to go on; or 2) you can install the certificate and have it be recognized as trusted.

- ◆ If you are working on a computer at another location, accept the certificate for just this session by clicking **Yes**.
- ◆ If you are working at your own computer, install the certificate on your computer (see below for details). After the certificate is installed, it will be recognized as trusted.



## Installing the Certificate

To install the certificate, do the following:

1. In the *Security Alert* dialog box, click **View Certificate**. The *Certificate Information* dialog box appears:

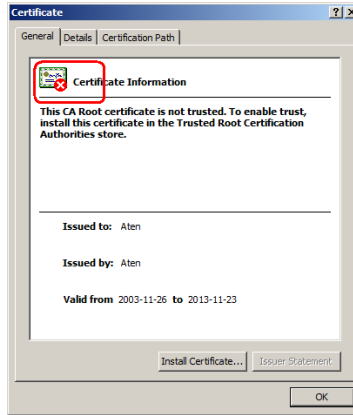

**Note:** There is a red and white X logo over the certificate to indicate that it is not trusted.

2. Click **Install Certificate**.
3. Follow the Installation Wizard to complete the installation. Unless you have a specific reason to choose otherwise, accept the default options.
4. When the Wizard presents a caution screen:

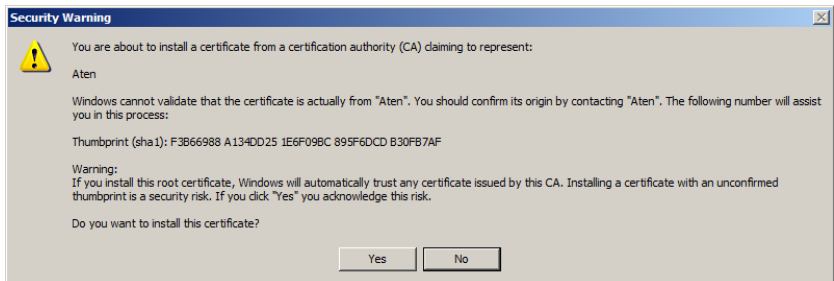

Click **Yes**.

- Next, click **Finish** to complete the installation; then click **OK** to close the dialog box.

## Certificate Trusted

The certificate is now trusted:

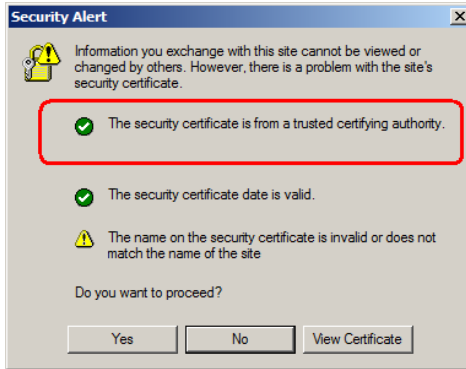

When you click *View Certificate*, you can see that the red and white **X** logo is no longer present – further indication that the certificate is trusted:

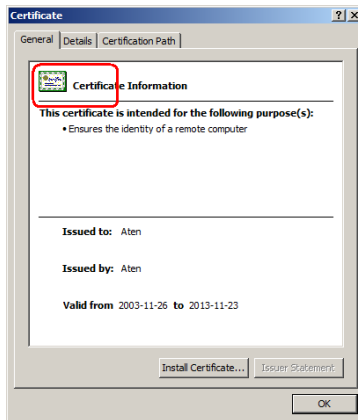

## Specifications

Function		Specification
Power Inlets		1 x IEC 60320/C14 (M)
Power Outlets		8 x IEC 60320/C13 (F)
LEDs	Outlet Power	8 (orange)
	Remote Access	8 (green)
	Station ID	2 x 7 segment (yellow)
Connectors	PON In	1 x DB-9 (F)
	PON Out	1 x DB-9 (M)
	Safe Shutdown	8 x 6-pin Safe Shutdown Jacks (F)
Switches	Power	1 x Rocker
	Outlet On / Off Remote On / Off	8 x Pushbutton
	FW Upgrade	1 x 2 position slide
	Reset	1 x Semi hidden
I/P Rating (Total input)		100 ~ 120V, 50/60Hz, 12A (max) 220 ~ 240V, 50/60Hz, 10A (max)
O/P Rating	Per Port	100 ~ 120V, 50/60Hz, 9A (max) 220 ~ 240V, 50/60Hz, 9A (max)
	Total	100 ~ 120V, 50/60Hz, 11A (max) 220 ~ 240V, 50/60Hz, 9A (max)
Power Consumption	No Load	120V; 60Hz; 15W 230V; 50Hz; 15W
	Max Load	120V; 60Hz; 1440W 230V; 50Hz; 2300W
Environment	Operating Temp.	0—40°C
	Storage Temp.	-20—60°C
	Humidity	0—80% RH Noncondensing
Physical Properties	Housing	Metal
	Weight	3.7 kg
	Dimensions (LxWxH)	43.2 x 21 x 4.4 cm

## Limited Warranty

---

ATEN warrants this product against defects in material or workmanship for a period of one (1) year from the date of purchase. If this product proves to be defective, contact ATEN's support department for repair or replacement of your unit. ATEN will not issue a refund. Return requests can not be processed without the original proof of purchase.

When returning the product, you must ship the product in its original packaging or packaging that gives an equal degree of protection. Include your proof of purchase in the packaging and the RMA number clearly marked on the outside of the package.

This warranty becomes invalid if the factory-supplied serial number has been removed or altered on the product.

This warranty does not cover cosmetic damage or damage due to acts of God, accident, misuse, abuse, negligence or modification of any part of the product. This warranty does not cover damage due to improper operation or maintenance, connection to improper equipment, or attempted repair by anyone other than ATEN. This warranty does not cover products sold AS IS or WITH FAULTS.

IN NO EVENT SHALL ATEN'S LIABILITY EXCEED THE PRICE PAID FOR THE PRODUCT. FURTHER, ATEN SHALL NOT BE RESPONSIBLE FOR DIRECT, INDIRECT, SPECIAL, INCIDENTAL OR CONSEQUENTIAL DAMAGES RESULTING FROM THE USE OF THE PRODUCT, ITS ACCOMPANYING SOFTWARE, OR ITS DOCUMENTATION. ATEN SHALL NOT IN ANY WAY BE RESPONSIBLE FOR, WITHOUT LIMITATION, LOSS OF DATA, LOSS OF PROFITS, DOWNTIME, GOODWILL, DAMAGE OR REPLACEMENT OF EQUIPMENT OR PROPERTY, AND ANY EXPENSES FROM RECOVERY, PROGRAMMING, AND REPRODUCTION OF ANY PROGRAM OR DATA.

ATEN makes no warranty or representation, expressed, implied, or statutory with respect to its products, contents or use of this documentation and all accompanying software, and specifically disclaims its quality, performance, merchantability, or fitness for any particular purpose.

ATEN reserves the right to revise or update its product, software or documentation without obligation to notify any individual or entity of such revisions, or update.

For details about extended warranties, please contact one of our dedicated value added resellers.

## A

- Administration, 37
- Administrator Login Failure, 63
- ALTUSEN Information, xiv

## C

- Components
  - Front view, 5
  - Rear view, 7
- Corrupt Password, 63

## D

- Default Login, 17
- Device control, 32
  - configuration, 38
  - Log, 45
  - monitor, 44
  - power status, 33
  - schedule, 42
  - user management, 43

## F

- FCC Information, ii
- Features, 3
- Firmware upgrade, 53
- Forgotten Password, 63

## H

- Hardware Setup
  - Rear View, 7
- Hyperterminal, 25

## I

- Installation
  - Single stage, 11

## L

- LEDs
  - Port, 5
- Log, 45
- Logging in, 18, 20
  - CN6000, 15
- Login failure, 63

## M

- Main Screen, 31
  - PN9108, 19
  - SN0108/SN0116, 21
- Monitor, 44

## O

- Operation
  - Hyperterminal, 25
  - Java Application, 29
  - Local console, 25
  - PN9108 Browser, 18
  - SN0108/SN0116 Browser, 20
- Outlet configuration, 38
- Overview, 1

## P

- Port
  - LEDs, 5
- Power status screen
  - Bottom panel, 35
  - Top panel, 33

## R

- Rack Mounting, 10
- Rack mounting, 10
- Requirements, 4

## **S**

Safety Instructions

General, iv

Rack Mounting, vi

Schedule, 42

Single stage installation, 11

Stacking, 9

Supported KVM switches, 62

## **T**

Trusted Certificates, 64

## **U**

User management, 43

User Notice, iii