



ALPHASONIK®

Owner's Manual

**Alpha 800 Series
Subwoofers**

PSW810E / PSW812E / PSW815E

ALPHASONIK WAS FOUNDED IN 1976 WITH ONE MISSION, TO BRING STATE OF THE ART PERFORMANCE TO THE CAR AUDIO ENTHUSIAST.

In those early years we pioneered such ground-breaking technologies as amplifier fan cooling and high voltage signal transfer which remain a benchmark in high-end audio.

Today, the new Alphasonik is committed to pushing the envelope with regard to technology, quality and value. Our electronics feature audiophile parts and circuit topology designed to let the full musical experience come through, loud and clear. Our loudspeakers employ the latest high technology materials and processes such as carbon reinforced woven glass and titanium vapor deposition to deliver your music with tremendous impact, dynamics and resolution.

We stand behind our quality with one of the best warranties in consumer electronics. Compare Alphasonik car audio products against anything competition has to offer. We're confident you will come to one conclusion...



Introduction.....3

Features and Specifications.....4-5

Building an Enclosure.....6-10

Subwoofer Parameters.....11

Wiring Diagrams.....12-14

Troubleshooting.....15

Warning / Disclaimer.....16

Warranty.....17 - 18

Thank you for purchasing this Alphasonik product. Alphasonik products are specifically engineered and designed for the mobile audio environment. This manual contains important information about installation, set-up procedures and integrating your new Alphasonik product into your vehicle. With proper care and installation, your new product will provide you with many years of high performance listening enjoyment. We recommend having an Authorized Alphasonik Dealer install your new product for optimal performance and to take advantage of our warranty program. Before installing your new product, please read through the manual to fully understand the application.

Before making any electrical connections, make sure that you disconnect the battery's ground cable to prevent the possibility of short circuits or damage to your electronic equipment. If your vehicle's stereo (head unit) comes with an Anti-theft code, DO NOT disconnect the battery. If you have the access code for the stereo (head unit), please refer to the vehicle's owner's manual.

All Alphasonik 800 Series cast basket subwoofers feature our patent pending input and output terminals. Configure voice coils or drivers in series or parallel with no fuss and no cramped or frayed wires. Terminals are audiophile grade nickel-plated, machined brass – compression fit with Allen head setscrews

PROPRIETARY HEAT SINK

All Alphasonik 800 Series subwoofers have motor structures encased in patent pending, cast aluminum, machine finished heat sinks. Power handling is enhanced because excess heat is quickly absorbed and transferred to the environment. The music may get hot but our subs run cool.

BASKET WEAVE, KEVLAR® REINFORCED KRAFT PULP CONE

All Alphasonik 800 Series subwoofers use our environmentally treated Kevlar reinforced, Kraft pulp cone – the most neutral sounding material in the industry. Virgin, long-fiber Kraft pulp is air cured and strengthened with Kevlar®. If you beat on our subs, they hit back.

HIGH TENSILE STRENGTH DUAL LAYER SURROUND

All Alphasonik 800 Series subwoofers feature a massive 2-layer, high-travel surround for reliability and control at maximum excursion

PSW810E

10" ALPHA 800 SERIES SUBWOOFER

Proprietary Cast Aluminum Alloy Machine Cut "Alpha" Basket
 Proprietary Cooling Rings for Motor Assembly (Patent Pending)
 Kevlar® Reinforced Composite Balanced & Laminated Cone
 High Tensile Strength Two-Layer Surround for Enhanced Control
 Flat Progressive Rate Nomex® Damper w/ Spiral-Woven Leads
 135 oz. Double Stack Magnet
 Rated at 800 Watts RMS
 89dB Efficiency
 Frequency Response of 29Hz to 500Hz
 Dual 4 ohm 2 1/2" Voice Coils
 8-Gauge Sure-Lok Input and Output Terminals (Patent Pending)
 Mounting Dimensions — Depth: 154mm / 6 1/8"
 Through Hole: 225mm / 8 7/8" Diameter: 258mm / 10 3/16"

PSW812E

12" ALPHA 800 SERIES SUBWOOFER

Proprietary Cast Aluminum Alloy Machine Cut "Alpha" Basket
 Proprietary Cooling Rings for Motor Assembly (Patent Pending)
 Kevlar® Reinforced Composite Balanced & Laminated Cone
 High Tensile Strength Two-Layer Surround for Enhanced Control
 Flat Progressive Rate Nomex® Damper w/ Spiral-Woven Leads
 135 oz. Double Stack Magnet
 Rated at 900 Watts RMS
 92dB Efficiency
 Frequency Response of 28Hz to 500Hz
 Dual 4 ohm 2 1/2" Voice Coils
 8-Gauge Sure-Lok Input and Output Terminals (Patent Pending)
 Mounting Dimensions — Depth: 168mm / 6 5/8"
 Through Hole: 275mm / 10 7/8" Diameter: 312mm / 12 5/16"

PSW815E

15" ALPHA 800 SERIES SUBWOOFER

Proprietary Cast Aluminum Alloy Machine Cut "Alpha" Basket
 Proprietary Cooling Rings for Motor Assembly (Patent Pending)
 Kevlar® Reinforced Composite Balanced & Laminated Cone
 High Tensile Strength Two-Layer Surround for Enhanced Control
 Flat Progressive Rate Nomex® Damper w/ Spiral-Woven Leads
 150 oz. Double Stack Magnet
 Rated at 1000 Watts RMS
 94dB Efficiency
 Frequency Response of 24Hz to 500Hz
 Dual 4 ohm 3 " Voice Coils
 8-Gauge Sure-Lok Input and Output Terminals (Patent Pending)
 Mounting Dimensions — Depth: 201mm / 8"
 Through Hole: 351mm / 13 7/8" Diameter: 388mm / 15 1/16"

Now that you know about subwoofer specifications it's time to learn about building subwoofer boxes. If you've done any woodworking you shouldn't have much trouble when building a subwoofer enclosure. One of the main differences will probably be the material used in building subwoofer boxes as compared to other woodworking projects. When building a custom subwoofer box you will want to use minimal MDF (medium density fiberboard).

TOOLS REQUIRED TO BUILD AN ENCLOSURE

Safety goggles

Table saw or circular saw

Powered screw gun

Router or jig saw

Variety of sizes of drill bits

Wood glue

Silicone

Wood screws

To ensure your safety while building an enclosure, please read all manuals for the power tools you will be using, as they will include valuable information on handling the tools and safety tips.

If you're planning to build your own enclosure and are confused in what type of enclosure best suits your needs this page will help you choose what enclosure fits your needs. There are many different types of enclosures. The two most common used enclosures are sealed and vented enclosure. This page will show the advantages and disadvantages of the two enclosures.

Advantages of a sealed enclosures

- *High power handling capability
- *Great transient response
- *Tolerant of minor enclosure size variation
- *Easy to construct
- *Smooth rolloff (12dB/octave)

Disadvantages of a sealed enclosures

- *Requires a woofer with a long excursion for better low bass frequency response.
- *Can have lower sensitivity than ported enclosures.
- *When using high power and small enclosures, the woofer is not in an ideal cooling environment.
- *Less low bass as compared to a properly tuned vented enclosure above the ported tuning frequency.

Advantages of a vented enclosure

- *Increased output around vented tuning
- *Higher power handling above the port tuning frequency
- *Extended frequency response
- *Magnet is in a good cooling environment
- *Handles higher bass frequencies with less distortion

Disadvantages of a vented enclosure

- *Vented enclosure transient response is not as good as sealed boxes because of the resonant effect of the vent tuning
- *Midrange sound coming from inside the enclosure through the vent can produce unpleasant sound coloration.
- *Loss of cone movement control below vent tuning, which can result in high distortion and mechanical failure of the driver.
- *Lower power handling below the port tuning frequency.

Calculating speaker enclosure volume is a five step procedure.
 (Make sure you do not forget to subtract the thickness of the wood that you have selected to use to build your enclosure.)

- Step One: Measure Height
- Step Two: Measure Width
- Step Three: Measure Depth
- Step Four: Height x Width x Depth
- Step Five: Divide the results were in step four by 1728
 (12" x 12" x 12"=1728 which equals to 1.0 cu ft.)

Complete formula should look like this
 Height x Width x Depth / 1728 = _____

Below are illustrated versions of all the steps that you should take.
 (FOR EXAMPLE ONLY)

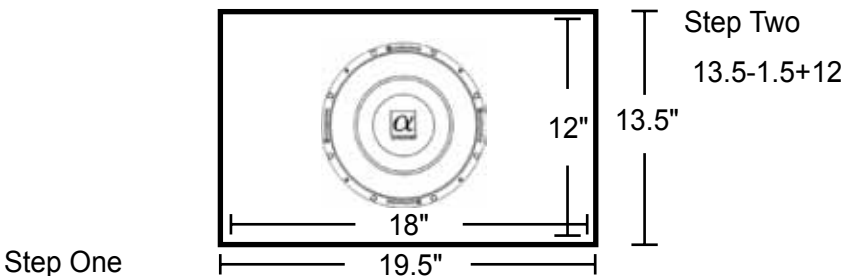

The wood that we are using is 0.75" thick
 The 1.5 that you see in the formula is the thickness of the wood.

Step Three
 Side View

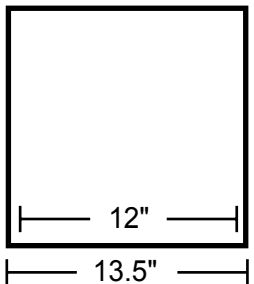

Calculating thickness of wood:
 Measure how thick the wood is then multiply by two.
 The reason that you are multiplying by two is each side of the enclosure.

- Left + Right=1.5
- Top + Bottom=1.5
- Front + Back=1.5

$$.75 \times 2 = 1.50$$

$$18 \times 12 \times 12 = 2592$$

$$2592 / 1728 = 1.5$$

1.5 cu. ft. is the results for this enclosure

Calculating speaker enclosure volume is a five step procedure.
(Make sure you do not forget to subtract the thickness of the wood and port displacement that you used.)

Step One: Measure Height

Step Two: Measure Width

Step Three: Measure Depth

Step Four: Height x Width x Depth

Step Five: Divide the results in step four by 1728
(12" x 12" x 12"=1728 which equals to 1.0 cu ft.)

Complete formula should look like this

Height x Width x Depth / 1728 = _____

Below are illustrated versions of all the steps that you should take.
(FOR EXAMPLE ONLY)

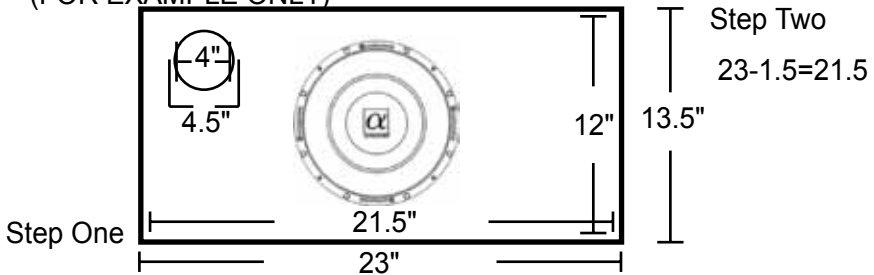

The wood that we are using is 0.75" thick

The 1.5 that you see in the formula is the thickness of the wood.

To calculate the thickness of the wood.

Step Three
Side View

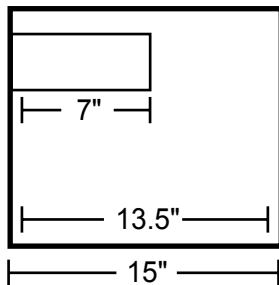

$$15 - 1.5 = 13.5$$

Left + Right=1.5

Top + Bottom=1.5

Front + Back=1.5

$.75 \times 2 = 1.50$

$21.5 \times 13.5 \times 12 = 3483$

$3483 / 1728 = 2.01$

2.01 cu. ft. is the result for this enclosure.

Formula to calculate port displacement

$3.14 \times \text{Radius} \times \text{Radius} \times \text{Depth} =$

_____ / 1728 = port displacement

$3.14 \times 2.25 \times 2.25 \times 7 = 111.27$ sq. in.

$111.27 / 1728 = .06$ is the displacement of the port

$2.01 - 0.06 = 1.95$ cu.ft. is the final result for this enclosure.

Converting a round port to a slot port.

Calculate the area of the round port(s) being used, then use the square root function of your calculator to get the interior dimensions of an equivalent square port. The length (or depth) of the slot port will be the same as that of the round port.

To calculate area: (Area is a two dimensional measurement)

Circle = $3.14 \times \text{Radius} \times \text{Radius}$

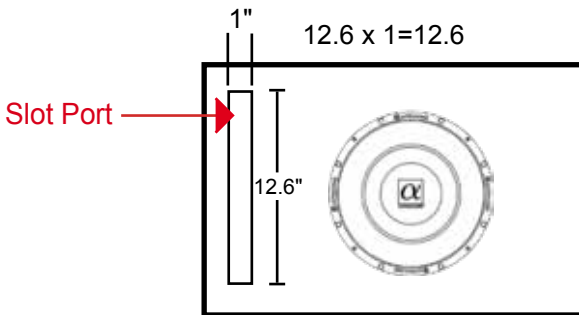
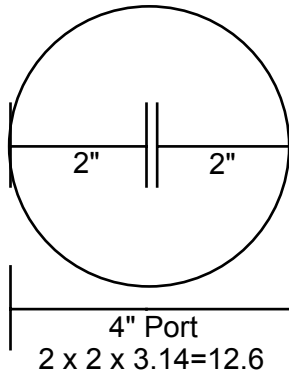
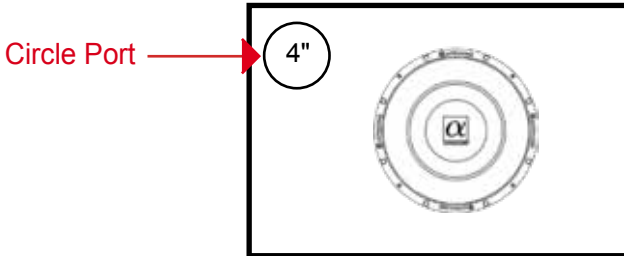

800 Series

Model #	PSW810E	PSW812E	PSW815E
Fs	28	25	20
Qts	0.38	0.42	0.35
Qes	0.4	0.44	0.35
Qms	7.2	0.45	7.2
Vas (liters)	28	42	1.41
Vas (Cu. Ft.)	1	1.5	5
Re	3.6 x 2	3.6 x 2	3.6 x 2
Rms	800	900	1000
Xmax +/- (mm)	14.5	14	15
Le	0.85	1.3	1.05
Sd	0.033	0.044	0.075
SPL	89	92	94
EBP	70	57	57
Mmd	180	240	300
Freq. Resp.	29Hz-500Hz	28Hz-500Hz	24Hz-500Hz

Mounting Dimensions

Depth (mm)	155mm	168mm	203mm
Depth (Inches)	6 1/8"	6 5/8"	8"
Through Hole (mm)	225mm	276mm	352mm
Through Hole (Inches)	8 7/8"	10 7/8"	13 7/8"
Diameter (mm)	258mm	312mm	383mm
Diameter (Inches)	10 3/16"	12 5/16"	15 1/16"
Displacement	.156 Cu.Ft.	.203 Cu.Ft.	.328 Cu.Ft.

Sealed Enclosures

Minimum Sealed	0.5	0.75	1.25
Sensitivity/dB	N/A	84	N/A
Maximum Sealed	1.25	1.5	2
Sensitivity/dB	N/A	84	N/A

Vented Enclosures

Minimum Vented	2	2.5	3.5
Internal Volume	1.8	2.1	3.1
Port Dia/Inches	4	2x4	2x4
Port Length/Inches	12	11	9.5
(-3dB)	30	35	33
Tuning Freq.	35	45	40
Port Displacement	0.08	0.15	0.12
Maximum Vented	3	4	5
Internal Volume	2.8	3.6	4.6
Port Dia/Inches	4	2x4	2x4
Port Length/Inches	10.25	10.75	12
(-3dB)	26	28	25
Tuning Freq.	30	35	30
Port Displacement	0.06	0.14	0.16

Parallel-Parallel Dual 4 Ohm

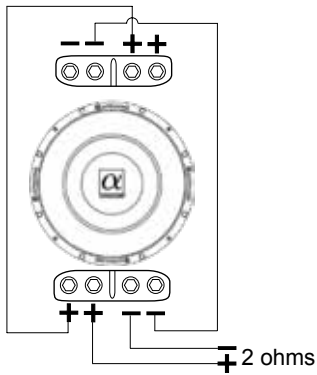
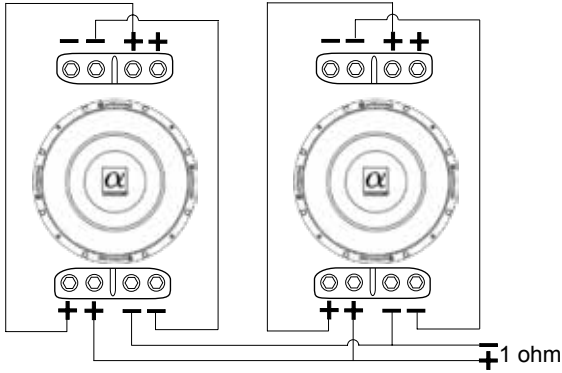
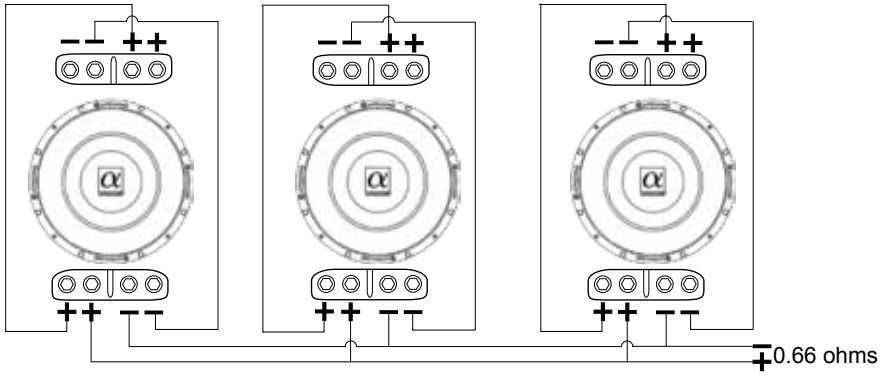

Patent No: US D478,556 S
Patent No: US 6,601,645 B1
Patent No: US 6,656,000 B2

Series-Parallel Dual 4 Ohm

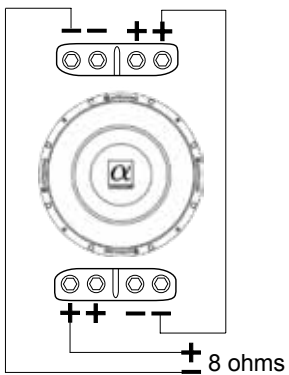
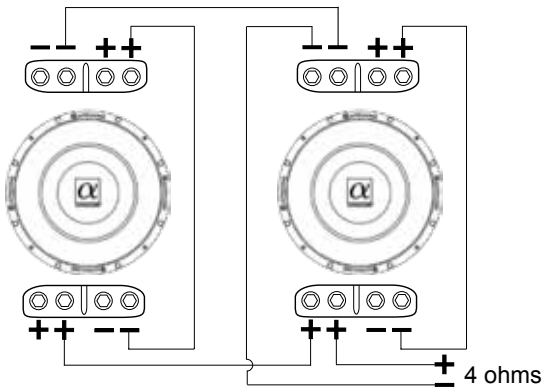
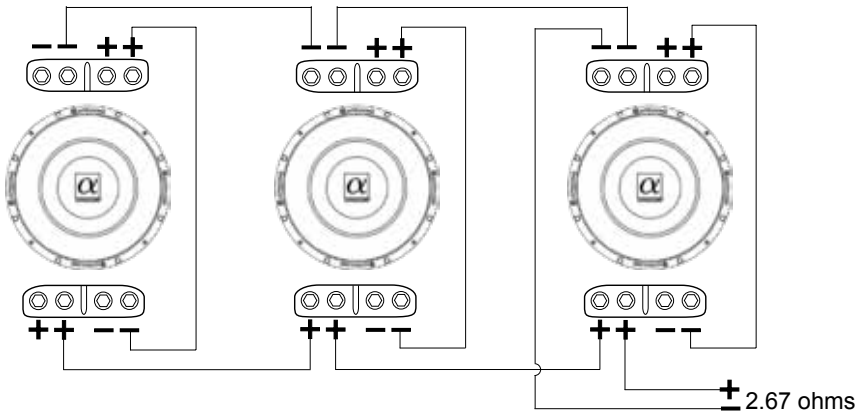

Patent No: US D478,556 S
Patent No: US 6,601,645 B1
Patent No: US 6,656,000 B2

Series-Series Dual 4 Ohm

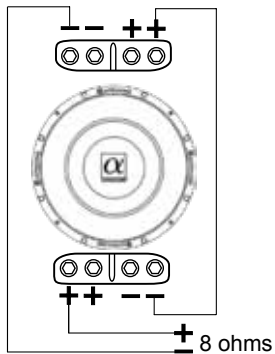
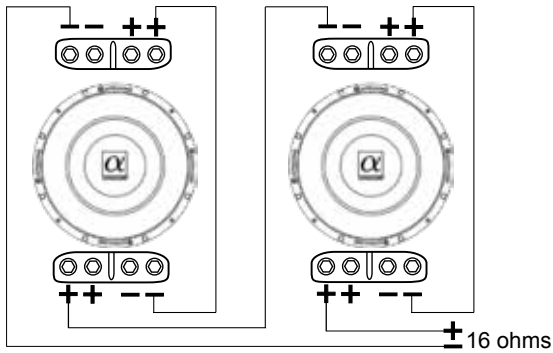
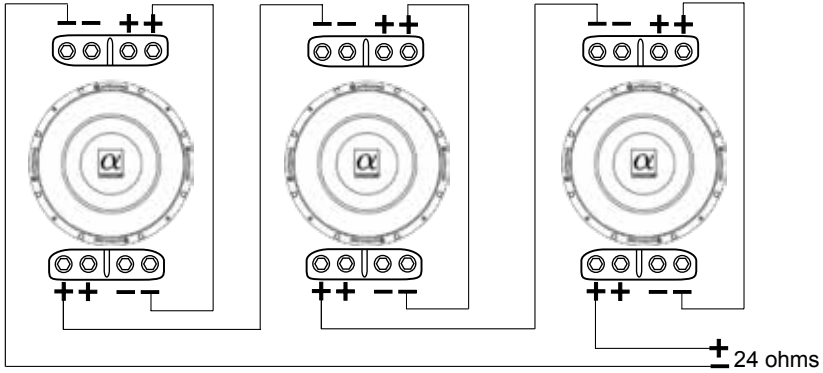

Patent No: US D478,556 S
Patent No: US 6,601,645 B1
Patent No: US 6,656,000 B2

SYMPTOM	CHECK POINT	CURE
No sound	Is the amplifier power LED illuminated?	<ol style="list-style-type: none"> 1. Check fuses in amplifier 2. Check turn-on lead 3. Check signal leads 4. Check gain control 5. Check source unit volume 6. Clean contacts on fuse holders
	Is the amplifier overload LED illuminated?	Check speaker for short or amplifier for overheating
	Check impedance with Ohm meter	If no reading, replace speaker
	Check that the speaker moves freely	If speaker won't move, replace speaker
<hr/>		
Speaker is making a rattling noise	Check that speaker is secured properly and tightened with screws	Tighten mounting screws
	Check enclosure construction	Check that the enclosure is debris free
	Check speaker polarity	Correct polarity
<hr/>		
No sound from one coil	Check speaker leads	<ol style="list-style-type: none"> 1. Inspect for short circuits 2. Check for open connections
		Reverse left and right speaker leads to determine if it is occurring before the speaker
<hr/>		
Speaker is distorting at high volume levels	Check speaker load impedance capabilities for the amplifier	Confirm that the speaker load impedance recommendations are followed. Check the wiring configuration of the speakers. (To verify proper load impedance, use an OHM meter to measure the total load for each channel of the amplifier.
	Verify that amplifier and/or crossover settings are correct	Select low-pass setting

Investigate the layout of your vehicle thoroughly before drilling or cutting. Take care when you work near the gas tank, gas lines, hydraulic lines, electrical components and electrical wiring. Do not use the equipment unmounted. Attach this system securely to prevent damage, particularly in the event of an accident or aggressive driving. Do not mount the system so that wire connections are unprotected or are subjected to pinching or damage from nearby objects. Before connecting or disconnecting power connections at the system power terminals, disconnect the +12V DC wire at the battery end. Confirm that your source unit and other equipment are turned off while connecting the input terminals. If you need to replace the power fuse, replace it only with a fuse identical to the provided fuse. Using a fuse of different type or rating may result in damage to the system, which is not covered by the manufacturer's warranty. Do not install any product where it may be subjected to excessive heat, moisture and dust or where it may be repeatedly kicked, brushed or bumped. Make absolutely sure that the terminals for the products are connected to the proper inputs and outputs from the music source. Never run the wiring on the outside of the vehicle or under it where it can be damaged by road hazards or any moving parts of the vehicle. Use existing wire channels, sills, panels and molding strips inside the vehicle to hide the wiring for safety and a neat appearance.

DISCLAIMER

IMPORTANT: Never cut any metal that is an integral part of the vehicle's safety or structural support system. If you are unsure, it is best to have the product professionally installed by an Authorized Alphasonik Dealer. Never sacrifice your safety for sound.

Alphasonik, Inc. warrants this product against all defects in material and workmanship for a period of one (1) year from the date of original purchase provided it was purchased from an Authorized Alphasonik, Inc. Dealer.

The conditions of this warranty and the extent of the responsibility of Alphasonik, Inc. under this warranty are as follows:

1. DATED PROOF OF PURCHASE IS REQUIRED FOR WARRANTY SERVICE OF THIS PRODUCT. Information about Alphasonik, Inc. authorized warranty service may also be obtained at www.alphasonikinc.com or by contacting or writing Alphasonik, Inc. at the address listed on the back of this booklet.

2. This warranty will become void if service is performed by any one other than an approved Alphasonik, Inc. Warranty Service Center.

3. This warranty does not apply to any product which has been subjected to misuse, neglect or accident, or which has had the warranty seal broken, serial number altered, defaced or removed, or which has been connected, installed adjusted or repaired other than in accordance with the instructions furnished by Alphasonik, Inc.

4. This warranty does not cover car static, electrical interference, adjustments or labor costs for the removal or reinstallation of the unit for repair.

5. The sole responsibility of Alphasonik, Inc. under this warranty shall be limited to the repair or replacement thereof, at the sole discretion of Alphasonik, Inc.

6. If it becomes necessary to send the product or any defective part to Alphasonik, Inc. or an authorized service station, the product must be shipped in its original or equivalent carton, fully insured, with shipping charges prepaid. Alphasonik, Inc. will not assume any responsibility for any loss or damage incurred in shipping.

7. This warranty is not transferable and protects the original purchaser provided they reside and made their purchase in the United States. International consumers may contact their local retailer or distributor for warranty information.

8. ALL IMPLIED WARRANTIES, EXCEPT TO THE EXTENT PROHIBITED BY APPLICABLE LAW, SHALL HAVE NO GREATER DURATION THAN THE WARRANTY PERIOD SET FORTH ABOVE. UNDER NO CIRCUMSTANCES SHALL ALPHASONIK INC. BE LIABLE FOR ANY LOSS OR DAMAGE, DIRECT OR CONSEQUENTIAL, ARISING OUT OF THE USE OR INABILITY TO USE THE PRODUCT. BECAUSE SOME STATES DO NOT ALLOW LIMITATIONS ON HOW LONG AN IMPLIED WARRANTY LASTS OR EXCLUSIONS OR LIMITATIONS OF INCIDENTAL OR CONSEQUENTIAL DAMAGES, THE ABOVE LIMITATIONS OR EXCLUSIONS MAY NOT APPLY TO YOU.

9. THIS WARRANTY GIVES YOU SPECIFIC LEGAL RIGHTS AND YOU MAY ALSO HAVE OTHER RIGHTS THAT VARY FROM STATE TO STATE.

10. Should you have any difficulties with the performance of this product during warranty or with any Alphasonik, Inc. authorized service center, you may contact the Alphasonik, Inc. National Service Manager at the address listed on the back of the booklet card or call 714.670.8950 for a listing of Authorized Warranty Service Centers in your area.

INSTALLED WARRANTY

(When purchased from and installed by an Authorized Alphasonik, Inc. Dealer)

Speaker and Accessories: 1-year over-the-counter defective exchange plus 1-year repair or replacement at the sole discretion of Alphasonik, Inc.

Electronics: 1-year over-the-counter defective exchange, plus 1-year repair or replacements at the sole discretion of Alphasonik, Inc.

An Alphasonik Extended Warranty Registration Card must be submitted to Alphasonik, Inc. within 30 days of purchase. To process any warranty claim, Alphasonik, Inc. will require the dated proof of purchase, which must specifically show the model and serial number and that installation was provided for the product in question. All other terms per Alphasonik, Inc.'s standard one-year warranty apply.



ALPHASONIK®

PROUD MEMBER OF



**ALPHASONIK INC.
7050 VILLAGE DRIVE BLDG. G
BUENA PARK, CALIFORNIA. 90621
TEL: (714)670-8950 · FAX: (714)670-8959**

www.alphasonikinc.com