

TOPFIELD

TF 7700 HSCI

User Guide

*High Definition
Digital Satellite Receiver
Common Interface*



DVB
Digital Video
Broadcasting

Contents

1	Introduction	1
1.1	Features	1
1.2	Controlling the digital receiver	2
1.2.1	The front panel	2
1.2.2	The remote control	4
1.3	What is common interface?	6
2	Setup	7
2.1	Unpacking	7
2.2	Safety precautions	7
2.3	Rear panel connections	9
2.4	Connecting up your digital receiver	10
2.4.1	Connecting the antenna	10
2.4.2	Connecting to your television	11
2.4.3	Connecting to your video cassette recorder	13
2.4.4	Inserting batteries in the remote control	14
3	Preference Settings	15
3.1	Language settings	15
3.2	Video and audio settings	16
3.2.1	Colour model	16

3.2.2	Video cassette recorder	17
3.2.3	Television aspect ratio	17
3.2.4	High definition television	18
3.2.5	Sound mode	19
3.3	Local time setting	19
3.4	Parental control	22
3.5	Adjusting the on-screen display	23
4	Service Search	24
4.1	Searching broadcasting services	24
4.1.1	Configuring LNB settings	24
4.1.2	Configuring DiSEqC 1.2 settings	26
4.1.3	Configuring USALS settings	28
4.1.4	Searching services	29
4.2	Editing the transponder list	32
4.3	Resetting to factory settings	33
4.4	Resetting to installer settings	33
5	Daily Usage	35
5.1	Volume control	35
5.2	Watching television	35
5.2.1	The services list	35
5.2.2	The favourite services list	38
5.2.3	Viewing programme information	39
5.2.4	Selecting audio tracks	40
5.2.5	Selecting subtitle tracks	40
5.2.6	Viewing teletext	40
5.3	Viewing electronic programme guide	40
5.4	Watching multifeed programme	42
5.5	Making timer events	42

6	Listing Services	44
6.1	Editing the services list	44
6.2	Editing the favourite list	46
6.3	How to use on-screen keyboard	48
6.4	Transferring receiver data	48
7	Firmware Update	50
7.1	From a USB storage	51
7.2	From your computer via RS-232 port	51
7.3	From another digital receiver via RS-232 port	52
	Index	54

Chapter 1

Introduction

The TF 7700 HSCI digital receiver is fully compliant with the international Digital Video Broadcasting (DVB) standard, and can receive digital broadcasts. For its operation, you need an antenna, which must be installed appropriately.

NOTE

In general we equate a channel with a frequency. However, unlike analogue broadcasts, digital broadcasts are not all assigned to their own frequencies; instead, multiple television broadcasts are transmitted through a single frequency. The frequency in digital broadcasting is usually called transponder. To reduce confusion in this manual, the word **service** is preferably used than **channel** as a term to indicate one television or radio broadcast.

1.1 Features

The TF 7700 HSCI digital receiver has the following features:

- Supports DiSEqC 1.0, DiSEqC 1.1, DiSEqC 1.2 and USALS.

- Can store up to 5000 television and radio services.
- You can edit the services list.
- You can make a favourite list with your favourite services.
- You can view information about the current television or radio programme.
- Has an electronic programme guide that provides an overview of programme schedules for next few hours.
- You can update the firmware of the digital receiver to the latest version, which will be provided by the manufacturer.

1.2 Controlling the digital receiver

The digital receiver can be operated with the remote control and the buttons on the front panel.

NOTE

When the digital receiver is off but plugged into a wall outlet, we say that it is in standby mode; on the other hand, when it is on, it is in operation mode. Even when you are not using the digital receiver, you should keep it plugged into a wall outlet to be in standby mode so that it can run timer events at any time.

1.2.1 The front panel

The front panel of the digital receiver has buttons to control the digital receiver, and specific lamps and a display to indicate its status. The following indicates what they mean.

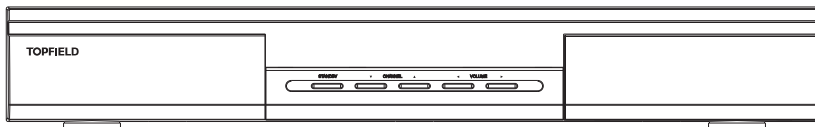

STANDBY button switches the digital receiver between standby mode and operation mode.

CHANNEL ▲, ▼ buttons move to the next or previous service. They are also used to navigate in the menus and interactive screens.

VOLUME ◀, ▶ buttons increase and decrease the volume. They are also used to change options for a menu item.

Front display displays the current time in standby mode, and displays the current service in operation mode.



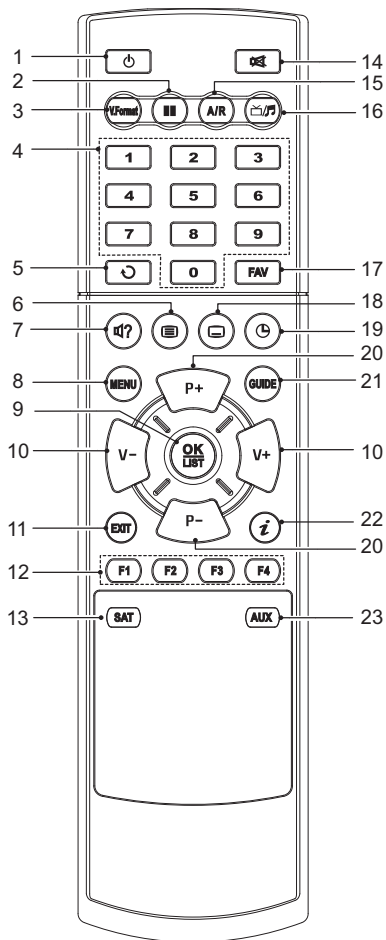









1.2.2 The remote control



- ① button switches the digital receiver between standby mode and operation mode.
- ② button pauses live television.
- ③ button changes video resolution. See § 3.2.4 for more details.
- ④ Numeric buttons are used to enter service numbers and menu options.
- ⑤ button switches between the current service and the previously viewed one.
- ⑥ button displays teletext.
- ⑦ button is used to select an audio track and sound mode, or a video track of multifeed programme.
- ⑧ button displays the main menu. It is also used to return to the previous menu from a sub-menu.
- ⑨ button displays the services list. It is also used to select menu items. See § 5.2.1 for more details.

⑩ , buttons increase and decrease the volume. They are also used to change options for a menu item.

⑪ button is used to leave the current screen.

- ⑫ These buttons have different functions per menu. They will be guided by on-screen help.
- ⑬  button displays the satellite list.
- ⑭  button mutes the sound. Press again to switch it back on.
- ⑮  button changes aspect ratio. See § 3.2.3 for more details.
- ⑯  button switches between television services and radio services.
- ⑰  button displays the favourite list.
- ⑱  button is used to select a subtitle track.
- ⑲  button sets a sleep timer.
- ⑳  ,  buttons move to the next or previous service. They are also used to navigate in the menus and interactive screens.
- ㉑  button displays the electronic programme guide.
- ㉒  button displays more information about the current programme or a programme highlighted in the electronic programme guide.
- ㉓  button switches the output of the TV SCART socket between the digital receiver and the device connected to the VCR SCART socket. See § 3.2.2 for more details.

1.3 What is common interface?

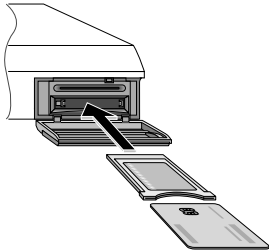

Some broadcasts are scrambled so that only paid subscribers can enjoy them. Scrambled services can only be viewed with a Conditional Access Module (CAM) and a subscription card belonging with the scrambling system.

Common Interface (CI) is an interface for conditional access modules. The front of the digital receiver has two common interface slots.

To watch a pay service, you should take the following steps:

1. Purchase a conditional access module and a subscription card for the pay service you want to watch.
2. Insert the subscription card into the conditional access module.
3. Insert the conditional access module into the common interface slot on the front of the digital receiver.



To view the information about the module and subscription card inserted into the digital receiver, select the Common Interface menu.

Chapter 2

Setup

2.1 Unpacking

Before going any further, check that you have received the following items with your digital receiver.

- Remote control unit
- Two batteries for the remote control (AAA 1.5 V)
- One component cable
- One HDMI cable (optional)
- A copy of this user guide

NOTE

Accessories may vary according to your local area.

2.2 Safety precautions

Please read the following safety precautions carefully.

- The mains power must be 90 to 250 volt. Check it before connecting the digital receiver to the wall outlet. For

the power consumption of the digital receiver, refer to Table 2.1.

- The wall outlet should be near the equipment. Do not run an extension lead to the unit.
- Do not expose the digital receiver to any moisture. The digital receiver is designed for use indoors only. Use dry cloth when cleaning the digital receiver.
- Place the digital receiver on a firm and level surface.
- Do not place the digital receiver close to heat emitting units or in direct sunlight, as this will impair cooling. Do not lay any objects such as magazines on the digital receiver. When placed in a cabinet, make sure there is a minimum space of 10 centimetres around it. For the physical specification of the digital receiver, refer to Table 2.2.
- Protect the power cord from being walked on or pinched. If wires are exposed or cord is damaged, do not use the digital receiver and get cord replaced.
- Never open the digital receiver casing under any circumstances. Warranty will be void.
- Refer all servicing to a qualified service technician.

Table 2.1: Power specification

Input voltage	90 to 250 V AC, 50/60 Hz
Power consumption	37 W at maximum in operation 8 W in standby

Table 2.2: Physical specification

Size	430× 60× 265 mm
Weight	2.9 kg
Operating temperature	0 to 45 °C
Storage relative humidity	5 to 95 %

2.3 Rear panel connections

The TF 7700 HSCI has some connections on the back panel.

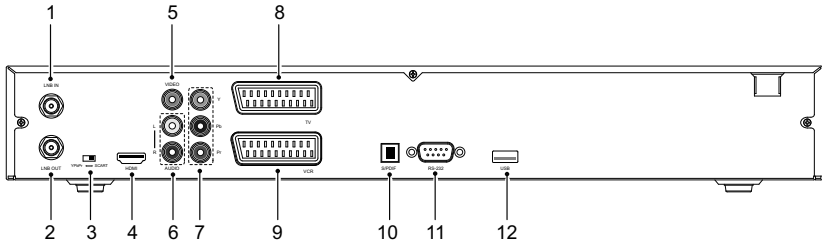

Check what connections your television set has in comparison with the digital receiver.

- ① LNB IN Satellite broadcasting signal input socket.
- ② LNB OUT Satellite broadcasting signal output socket through the LNB IN socket for another digital receiver.
- ③ YPbPr ↔ SCART Video output selection switch. See § 3.2.4 for more details.
- ④ HDMI Audio and video output socket for the high definition television set.
- ⑤ VIDEO Composite video output socket for the television set. (yellow)
- ⑥ AUDIO L/R Stereo audio output socket for the television set or audio system. (white/red)
- ⑦ Y/Pb/Pr Component video output socket for the television set. (green/blue/red)
- ⑧ TV Audio and video output socket for the television set.
- ⑨ VCR Audio and video input/output socket for the video cassette recorder or suchlike.

- ⑩ S/PDIF Dolby digital output socket for the audio system.
- ⑪ RS-232 Serial port for firmware update and data transfer.
- ⑫ USB USB port for firmware update and data transfer.

Table 2.3: Connectors specification

HDMI	High definition video output Left & right audio output Dolby digital audio output
VIDEO	composite video (CVBS) output
AUDIO	Left & right audio output
YPbPr	Component video (YUV) output
TV	CVBS/S-Video/RGB/YUV video output Left & right audio output
VCR	CVBS video output Left & right audio output CVBS/S-Video/RGB/YUV video input for bypass Left & right audio input for bypass
S/PDIF	Dolby digital audio output
RS-232	115.2 kbps at maximum
USB	2.0

2.4 Connecting up your digital receiver

There are several ways to set up the digital receiver. Set up the digital receiver suitably to your television and other appliances. If you have any problem with your setup or need help, contact your dealer.

2.4.1 Connecting the antenna

Whatever sort of connection you have between the digital receiver and the television, you need to connect the digital receiver to your television antenna so that it can receive digital television services.

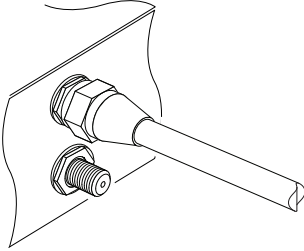

Connect the antenna cable to the LNB IN socket.

If you have another digital receiver, link it from the LNB OUT connector.

2.4.2 Connecting to your television

Between all the following connectors of your digital receiver, we recommend you use the first connector to get best picture quality. If your television does not have the matching connector then use the next connector in the following order for best picture quality.

1. HDMI connector (HDMI)
2. SCART connector (TV)
3. Component connector (YPbPr)
4. Composite connector (VIDEO)

You should configure audio and video settings after connecting up the digital receiver. See § 3.2 for detailed description.

To use the HDMI connector

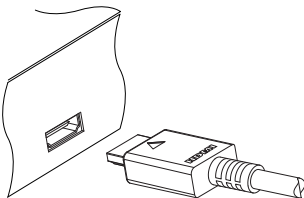

If you have a high definition television set, you should use a HDMI cable for best results. Plug one end of the cable into the HDMI socket on the digital receiver, and the other end into the matching socket on your television. In this case, you do not have to make audio connections because the HDMI connector can output stereo audio or Dolby digital audio.

To use the SCART connector

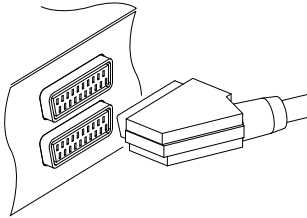

For best results with a standard television set, you should use a SCART cable, plugging one end into the TV socket on the digital receiver and the other end into a free SCART socket on your television.

Some televisions have inputs via Component or S-Video connectors rather than SCART.

If you have such a television, use an appropriate conversion cable to link the TV socket on the digital receiver to the matching socket on your television.

If you connect with a standard SCART cable, you do not have to make audio connections because the SCART connector can output stereo audio. But if you use a conversion cable, such as SCART-to-Component, you have to make audio connections.

NOTE

You cannot view high definition video with the SCART connector.

To use the component video connector

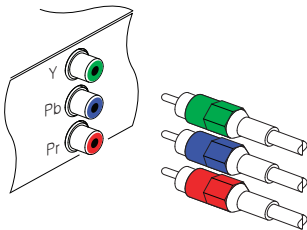

You will need to obtain a component video cable (RCA cable) to use the component video connector. Plug one end of the cables into the Y (green), Pb (blue) and Pr (red) sockets on the digital receiver, and the other end into the matching sockets on your television.

To use the composite video connector

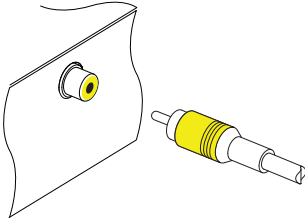

You will need to obtain a composite video cable (RCA cable) to use the composite video connector. Plug one end of the cable into the VIDEO (yellow) socket on the digital receiver, and the other end into the matching socket on your television.

NOTE

You cannot view high definition video with the composite video connector.

To connect the audio connectors

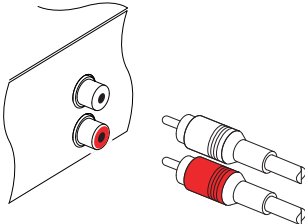

You will need to obtain an audio cable (RCA cable) to connect the audio connectors. Plug one end of the cable into the AUDIO L (white) and AUDIO R (red) sockets on the digital receiver, and the other end into the matching sockets on your television or audio system.

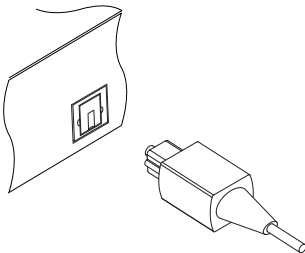

To enjoy Dolby digital audio, your television or audio system must be able to decode Dolby digital audio, and you will need to obtain a S/PDIF cable. Plug one end of the cable into the S/PDIF socket on the digital receiver, and the other end into the matching socket on your audio system.

2.4.3 Connecting to your video cassette recorder

The digital receiver can also output video to another appliance such as a video cassette recorder or video receiver through an auxiliary SCART connector.

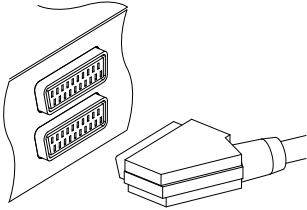

You will need to obtain a SCART cable to use the auxiliary SCART connector. Plug one end of the cable into the VCR socket on the digital receiver, and the other end into the matching socket on your video cassette recorder or suchlike.

2.4.4 Inserting batteries in the remote control

To insert the batteries, open the battery compartment by removing the lid, and then insert the batteries observing the polarity, which is marked on the base of the battery compartment.

If the digital receiver no longer reacts properly to remote control commands, the batteries may be flat. Be sure to remove used batteries. The manufacturer accepts no liability for damage resulting from leaking batteries.

NOTE

Batteries, including those which contain no heavy metals, may not be disposed of with household waste. Please dispose of used batteries in an environmentally sound manner. Find out about the legal regulations which apply in your area.

Chapter 3

Preference Settings

3.1 Language settings

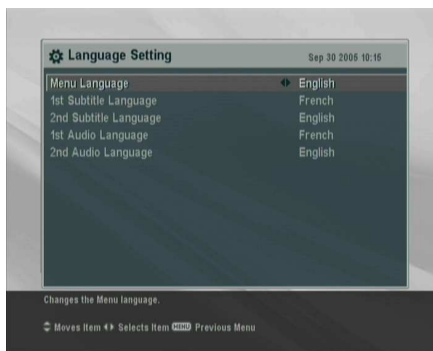

You can select the language in which the menu would be displayed. In addition to that, you can select which language of audio track as well as of subtitle track to be output.

Select the **System Setting** > **Language Setting** menu. You should see a screen like the left figure.

Menu language

The digital receiver supports many menu languages: Dutch, English, German, French, Italian, Russian, Turkish and so forth. Set the **Menu Language** option to your desired language. Once you select a language, the menu will be immediately displayed in the selected language.

Subtitle language

Set the Subtitle Language option to your desired language. When you watch a programme, the subtitle track of the selected language will be displayed if available.

Apart from this setting, you can select a subtitle track with the  button. See § 5.2.5 for further information.

Audio language

Set the Audio Language option to your desired language. When you watch a programme, the audio track of the selected language will be output if available.

Apart from this setting, you can select an audio track with the  button. See § 5.2.4 for further information.

3.2 Video and audio settings



You have to configure the video and audio settings appropriately to your television set and appliances.

Select the System Setting > A/V Output Setting menu. You should see a screen like the left figure.

3.2.1 Colour model

Through the TV SCART connector, the digital receiver is able to output video in various colour models. If you have the digital receiver linked to your television via this connector, you should set the SCART Output option to your desired colour model. If you have connected via the RCA connector labeled

VIDEO on the back panel, you do not have to set this option because the digital receiver outputs CVBS video through the RCA connector independent of SCART connector.

It is known in general that the RGB colour model provides the best video quality with little difference from the YUV colour model but the CVBS colour model does the least. So RGB would be most desirable for this option.

3.2.2 Video cassette recorder

You can have the digital receiver linked to your video cassette recorder or such an appliance via the VCR SCART connector. In that case, the digital receiver will operate differently depending on the setting of the VCR Scart Type option. If the option is set to Standard, the digital receiver will pass the video from the video cassette recorder to your television when it starts playback. But if the option is set to External A/V, the digital receiver will not pass the video automatically. To pass it, you have to press the **AUX** button.

3.2.3 Television aspect ratio

If you have a wide-screen television, set the TV Aspect Ratio option to 16:9.

Otherwise, if you have a normal-screen television, set the TV Aspect Ratio option to 4:3.

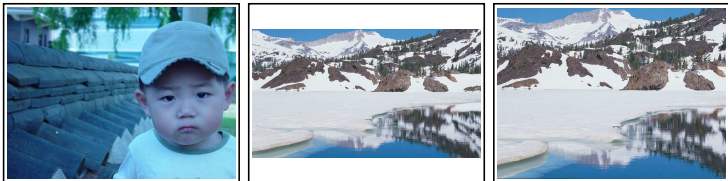

You cannot fully enjoy wide-screen programmes with your normal-screen television as the above figures show. The left figure shows a normal picture displayed in the normal screen. To watch wide-screen programmes in the shape like the center

figure, set the 16:9 Display Format option to Letter Box. Wide-screen pictures then will be reduced to fit to the width of the normal screen. Otherwise, to watch them in the shape like the right figure, set it to Center extract. Wide-screen pictures then will be cut out on the left and right sides equally to fit to the width of the normal screen.

3.2.4 High definition television

The digital receiver supports various video resolutions from 576 to 1080. In general a resolution of 720 or more is considered high definition. The higher the resolution is, the better quality you can enjoy. However, if your television set does not support high definition, you cannot enjoy high definition quality picture.

Set the Video Format option as you desire. If you set this option to 576P, the digital receiver will present even high definition programmes in resolution of 576. On the contrary, if you set it to 1080I, the digital receiver will present even standard definition programmes in resolution of 1080. It is recommended to set it to Auto if you have a high definition television. With that setting the digital receiver will present a programme as it is without any resolution conversion. You can change the resolution with the **V.Format** button when you are watching a programme. Whenever you press it, the video resolution is changed in turn.

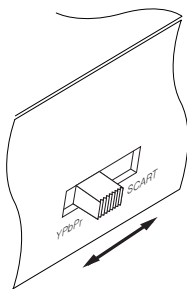

If you have the digital receiver linked to your television via the component video connectors (Y, Pb and Pr) or the HDMI connector you have to toggle the video output selection switch on the back panel to the YPbPr position. Otherwise if you have connected it to your television via the TV SCART connector, you have to toggle the switch to the SCART position. The available values of the Video Format option vary depending on which position you toggle the switch to.

NOTE

You can enjoy only standard definition video with the following connectors:

- Composite video connector (VIDEO)
- SCART connector (TV)

3.2.5 Sound mode

Basically, there are two audio sources as you can find two audio sockets on the back panel of the digital receiver. You can enjoy only one source or both of them in either stereo or mono. Set the **Sound Mode** option as you desire.

Apart from this setting, you can change the sound mode with the  button. See § 5.2.4 for detailed description.

The digital receiver can output two types of digital audio signals via the S/PDIF connector. One is an encoded signal, and the other is a decoded signal. If your digital audio appliance does not have a Dolby Digital decoder, you have to set the Dolby Digital option to PCM. Otherwise, set it to Bitstream.

3.3 Local time setting

You should set your local time for timer events. If you do not set the local time right, the programme time table provided by the programme guide may be distrustful. For the programme guide, refer to § 5.3.

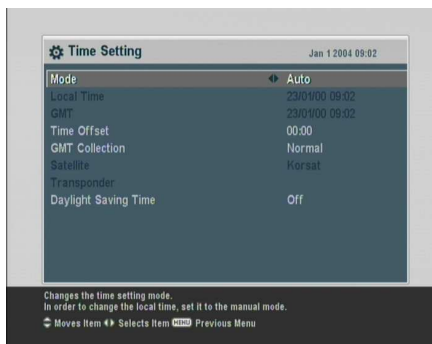

Select the System Setting > Time Setting menu. You should see a screen like the left figure.

You can make the local time to be automatically set by using Greenwich Mean Time (GMT).

To use Greenwich mean time, take the following steps:

1. Set the Mode option to Auto; then the Time Offset option becomes enabled.
2. Set the Time Offset option to the time difference between your time zone and GMT referring to Table 3.1.
3. To get Greenwich mean time, set the GMT Collection option to one among the following:

Normal from all transponders

CAS TP from transponders of pay services

User Select from transponders specified by you

If you set it to User Select, then the Satellite and Transponder options become enabled. Select your desired satellite and transponders at those options. With the above settings, the digital receiver will scan all transponders specified one by one until to get the Greenwich mean time.

4. Make sure that your local time is correctly displayed on the Local Time option.

To set the local time yourself, set the Mode option to Manual and enter your local time into the Local Time option with the numeric buttons. The time format is *day/month/year 24-hour:minute*.

Table 3.1: Time offset table

Time offset	City
GMT – 12:00	Eniwetok, Kwajalein
GMT – 11:00	Midway Island, Samoa
GMT – 10:00	Hawaii
GMT – 09:00	Alaska
GMT – 08:00	Pacific Time US, Canada
GMT – 07:00	Mountain Time US, Canada
GMT – 06:00	Central Time US, Canada, Mexico City
GMT – 05:00	Eastern Time US, Canada, Bogota, Lima
GMT – 04:00	Atlantic Time Canada, La Paz
GMT – 03:30	Newfoundland
GMT – 03:00	Brazil, Georgetown, Buenos Aries
GMT – 02:00	Mid-Atlantic
GMT – 01:00	Azores, Cape Verde Islands
GMT	London, Lisbon, Casablanca
GMT + 1:00	Paris, Brussels, Copenhagen, Madrid
GMT + 2:00	South Africa, Kaliningrad
GMT + 3:00	Baghdad, Riyadh, Moscow, St. Petersburg
GMT + 3:30	Tehran
GMT + 4:00	Abu Dhabi, Muscat, Baku, Tbilisi
GMT + 4:30	Kabul
GMT + 5:00	Ekaterinburg, Islamabad, Karachi, Tashkent
GMT + 5:30	Bombay, Calcutta, Madras, New Delhi
GMT + 6:00	Almaty, Dhaka, Colombo
GMT + 7:00	Bangkok, Hanoi, Jakarta
GMT + 8:00	Beijing, Perth, Singapore, Hong Kong
GMT + 9:00	Tokyo, Seoul, Osaka, Sapporo, Yakutsk
GMT + 9:30	Adelaide, Darwin
GMT + 10:00	Eastern Australia, Guam, Vladivostok
GMT + 11:00	Magadan, Solomon Islands, New Caledonia
GMT + 12:00	Fiji, Auckland, Wellington, Kamchatka

If daylight saving time is observed in your state at the moment, set the Daylight Saving Time option to On.

NOTE

Daylight saving adds one hour to the time when the option is set to On, and it removes one hour when the option is set to Off. When setting time offset via Greenwich Mean Time, make sure time does not include daylight saving.

3.4 Parental control

In general television programmes are classified according to the level of violence, nudity and language of its content. When you are watching a programme, you can check its programme classification on the information box. For the information box, see § 5.2.3.

You can prevent your children from watching specific programmes by specifying a programme classification.



Select the System Setting > Parental Control menu. You should see a screen like the left figure, and you will be asked your Personal Identification Number (PIN). The number is initially set to 0000.

If you wish to restrict 15 or above rated programmes, set the Censorship option to 15 (age). Setting it to No block restricts no programme; on the other hand, setting it to Total block restricts every programme.

NOTE

If a programme does not have any programme classification information, your censorship setting will not take effect.

If anyone is trying to watch a programme that is of or above the censorship setting, the person has to enter the personal identification number to override.

To change the number, select the Change PIN Code menu; then an input box appears. You have to enter a desired number twice for confirmation.

You can also restrict uses of some menus. Selecting the **Access Control** menu displays a list of menus that you can lock. If the **Time Setting** item is set to **Locked**, you have to enter the personal identification number to access the **Time Setting** menu. If you enter a wrong number, you cannot use the menu. To release a shut item, set it to **Unlocked**.

3.5 Adjusting the on-screen display

You can adjust the transparency level of the on-screen display. Select the **System Setting** menu and set the **OSD Transparency** option as you desire. Its available range is from 0 to 50 percent.

You can adjust the display time of the information box. For the information box, see § 5.2.3. To adjust its display time, select the **System Setting** menu and set the **Info Box Display Time** option as you desire. Its available range is from 1 to 30 seconds. If you set this option to **No Info Box**, the information box will not be displayed when you switch services. However, pressing the  button will display the information box. If you set this option to **Never Hide**, the information box will always be displayed.

In addition, you can raise or lower the position of the information box. Select the **System Setting** menu and set the **Info Box Position** option as you desire. Its available range is from -10 to +3 line. The more high the value is set, the more low the information box will be positioned.

Chapter 4

Service Search

After connecting up the digital receiver, you will need to perform a service search.

4.1 Searching broadcasting services

This digital receiver can be operated with both fixed and motorized antenna system. You have to configure antenna settings according to your antenna system in the following order:

1. Configure LNB settings. (Refer to § 4.1.1.)
2. Set the position of your desired satellites if you have a motorized antenna. You can control the antenna in DiSEqC 1.2 mode or USALS mode. Refer DiSEqC 1.2 to § 4.1.2, and refer USALS to § 4.1.3.
3. Perform service search.

4.1.1 Configuring LNB settings

There are in large two frequency bands for satellite broadcasts. One is C band which ranges approximately from 4 to 6 GHz.

The other is K_u band which ranges approximately from 12 to 18 GHz.



The LNB (Low Noise Block converter) is used to take a wide band of relatively high frequencies, amplify and convert them to similar signals carried at a much lower frequency, which is called IF (Intermediate Frequency).

High frequencies from satellites are converted into 950 to 2150 MHz by a LNB.

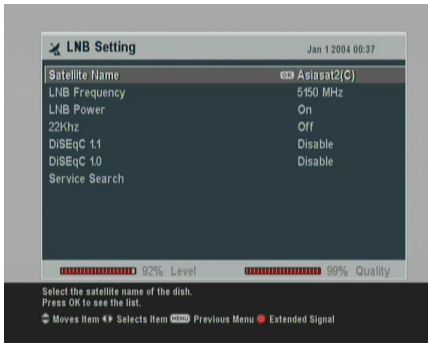

Select the Installation > LNB Setting menu to configure the LNB settings. You should see a screen like the left figure.

Pressing the **OK** button on the Satellite Name option displays the satellite list in alphabetic order. Select the satellite toward which your antenna is set to face. Even if you cannot find your desired satellite, you can add your desired satellite to the satellite list. See § 4.2 for detailed description.

The digital receiver has a database about broadcasting satellites and their transponders, containing the following information: satellite position, frequency range, symbol rate, polarization and LNB frequency corresponding to the frequency range. So you might not have to specify the LNB Frequency option. However, if you have selected the Other entry at the

Satellite Name option to specify a satellite that is not in the satellite list, you might have to fill in the correct LNB frequency. The absolute difference between a broadcasting frequency and its LNB frequency must be within 950 to 2150 MHz. For example, if the frequency band of your desired satellite ranges from 3660 to 4118 MHz, you have to set the LNB Frequency option to 5150 MHz.

The LNB has to be supplied with power to operate. Set the LNB Power option to On if it does not have any other power supply.

You had better ignore the 22 kHz option.

The digital receiver is designed to be compatible with DiSEqC (Digital Satellite Equipment Control) switches. It is possible to connect several antennas to one digital receiver by DiSEqC switches. A DiSEqC 1.0 switch allows switching between up to 4 satellite sources and a DiSEqC 1.1 switch allows switching between up to 16 satellite sources.

Set the DiSEqC 1.0 and DiSEqC 1.1 options according to your antenna configuration.

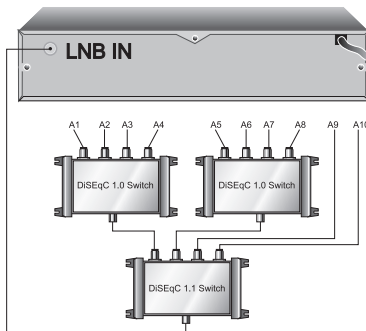

For example, to select the antenna connected to the A5 input in the left figure, set the DiSEqC 1.1 option to 2 of 4 and the DiSEqC 1.0 option to 1 of 4. If you have a mini DiSEqC 1.0 switch which has only two inputs, you should set the DiSEqC 1.0 option to Mini A instead of 1 of 4.

4.1.2 Configuring DiSEqC 1.2 settings

Your motorized antenna will turn toward your desired satellites horizontally by DiSEqC 1.2.



When you switch to a service, if the service is provided by a satellite other than current one, it will take longer time than usual because the antenna has to turn to its position.



To use the DiSEqC 1.2, select the Installation > Motorized DiSEqC 1.2 menu. You should see a screen like the left figure.

At first you have to set the Motorized DiSEqC 1.2 option to Enable.

To get the correct position of your desired satellite, perform the following steps:

1. Choose your desired satellite at the Satellite Name option.
2. Set the DiSEqC Command Mode to User.
3. Select the Goto option at the Motor Control menu. Then the antenna will turn toward your selected satellite with the position data that the digital receiver has.
4. If the receiving quality, which is displayed at the bottom right of the screen, is not good, tune the antenna finely with the options of the Movement menu. If you select the 2(E) movement option, the antenna will move to the east by two degrees. At this time you had better check the receiving quality of every transponder and choose the best one at the Transponder (or Frequency) option. It will be helpful to your fine tuning.

5. Finally select the Store option at the Motor Control menu to save the tuned position when the receiving quality has turned good.

There are more motor control options for installers, but this manual does not describe them. If you are an installer, refer them to the manual for the *STAB* rotor.

4.1.3 Configuring USALS settings

USALS (Universal Satellite Automatic Location System), also known as DiSEqC 1.3, calculates the positions of all available satellites from your location. Compared to DiSEqC 1.2, it is no longer required to manually search and store every satellite position. Just pointing to a known satellite position is enough. This position will act as the central point. The USALS will then calculate positions of visible satellites.



To use the USALS, select the Installation > USALS Setting menu. You should see a screen like the left figure.

At first you have to set the Motorized DiSEqC 1.3 option to Enable.

To calculate every satellite position, perform the following steps:

1. Choose your desired satellite at the Satellite Name option.
2. Input your location to the My Longitude and My Latitude options with the $\boxed{V-}$, $\boxed{V+}$ and numeric buttons.

3. Input the position of your selected satellite to the Satellite Angle option if it is not correct.
4. Select the Goto the position option. Then the antenna will turn toward your selected satellite calculating its position.
5. If the receiving quality, which is displayed at the bottom right of the screen, is not good, then tune the antenna finely with the options of the Move menu. The changed position is automatically saved. At this time you had better check the receiving quality of every transponder and choose the best one at the Transponder (or Frequency) option. It will be helpful to your fine tuning.

4.1.4 Searching services



To perform service search, select the Installation > Service Search menu. You should see a screen like the left figure.

There are four service search methods:

- Searching every service of a satellite.
- Searching every service of a transponder.
- Searching one service of a transponder.
- Searching every service of a SMATV (Satellite Master Antenna Television) transponder.

To search every service of a satellite, perform the following steps:

1. Choose your desired satellite at the Satellite Name option.
2. Set the Search Mode option to Auto.

To search every service of a transponder, perform the following steps:

1. Choose your desired satellite at the Satellite Name option.
2. Set the Search Mode option to Manual.
3. Choose your desired transponder at the Frequency option or input it with the numeric buttons.
4. Input the symbol rate of your desired transponder to the Symbol Rate option with the numeric buttons.
5. Set the Polarization option to the polarization of your desired transponder.
6. Set the Modulation option to the modulation method of your desired transponder. If your desired transponder has high definition broadcasts, you should set this option to DVB-S2 QPSK or DVB-S2 8PSK. Then the FEC option and the Pilot option will become enabled. You also should set these options correctly.

NOTE

You can get transponder information from a satellite magazine or web site such as <http://www.satcodx.com> or <http://www.lyngsat.com>.

To search one service of a transponder, perform the following steps:

1. Choose your desired satellite at the Satellite Name option.
2. Set the Search Mode option to Advanced.

3. Choose your desired transponder at the Frequency option or input it with the numeric buttons.
4. Input the symbol rate of your desired transponder to the Symbol Rate option with the numeric buttons.
5. Set the Polarization option to the polarization of your desired transponder.
6. Specify the PIDs of your desired service at the PID menu with the numeric buttons. PID (Packet Identifier) is a set of numbers that identifies transport stream packets.

To search every service of a SMATV transponder, if the digital receiver is connected to a SMATV, perform the following steps:

1. Choose your desired satellite at the Satellite Name option.
2. Set the Search Mode option to SMATV.
3. Choose your desired transponder at the Frequency option or input it with the numeric buttons.
4. Input the symbol rate of your desired transponder to the Symbol Rate option with the numeric buttons.
5. Set the Polarization option to the polarization of your desired transponder.

You can search pay services as well as free services. To search only free services, set the FTA/Scrambled option to FTA only. FTA means free service. To search only pay services, set it to CAS only. CAS means pay service. To search both free services and pay services, set it to FTA + CAS.

To start service search, select the Start Search item; then a list box appears, in which found services will be listed. When it has completed, press the **OK** button to save found services. To stop at any time, or to exit without saving, press the **EXIT** button.

4.2 Editing the transponder list



You can add, delete or modify satellite or transponder information. Select the Installation > SAT/TP Edit menu. You should see a screen like the left figure.

To add a satellite entry, select the **Add Satellite** option. Then the on-screen keyboard appears. Enter your desired name and save it. See § 6.3 for how to use the on-screen keyboard.

To change a satellite entry's name, select your desired entry at the **Satellite Name** option and select the **SAT Name Edit** option. Then the on-screen keyboard appears. Change the name as you desire and save it.

To delete a satellite entry, select your desired entry at the **Satellite Name** option and select the **Delete Satellite** option; then you are asked for confirmation. If you select **Yes**, it will be deleted.

To add a transponder entry, select your desired entry at the **Satellite Name** option and select the **Add new TP** option. Then a transponder information box appears. Input a frequency and its symbol rate with the numeric buttons, and specify its polarization.

To delete a transponder entry, select your desired entry at the **Frequency** option and select the **Delete TP** option; then you are asked for confirmation. If you select **Yes**, it will be deleted.

4.3 Resetting to factory settings

The digital receiver maintains the following data:

- Satellite list
- Services list
- Favourite list
- Timer list
- Preference settings

You can reset all data of the digital receiver. If you want to reset all the data, select the **Installation > Factory Setting** menu, then you will be asked for confirmation. If you select **Yes**, service entries, favourite entries and timer events will all be deleted, and preference options will be reset to the manufacturer's factory settings.

4.4 Resetting to installer settings

You can store your own data including the following:

- Satellite list
- Services list
- Favourite list
- Preference settings

Also you can restore them at any time.

To store your data, select the **Installation > System Recovery** menu and select the **Store** option; then the digital receiver will ask your personal identification number. The number may be different from yours because this function is usually permitted only to installers. If you have entered a right number, you will be asked for confirmation. If you select **Yes**, your data will be stored. Whenever you store your data, they are all overwritten. Refer personal identification number to § 3.4.

To restore your data, select the **Installation > System Recovery** menu and select the **Recover** option; then you will be asked

for confirmation. If you replay with **yes**, your data will be restored.

Chapter 5

Daily Usage

5.1 Volume control

Use the **(V-)** and **(V+)** buttons to alter the volume to a comfortable level. You may need to adjust the volume on your television set too. To temporarily switch off the sound, press the **(M)** button. Press it again to restore the sound to previous level.

5.2 Watching television

To change services, press the **(P+)** or **(P-)** button. Pressing the **(D)** button switches to the previously viewed service. You can switch to your desired service by entering its service number with the numeric buttons. You can also select a service to watch in the services list.

5.2.1 The services list

To view the services list, press the **(OK)** button.



On the services list, you can see the service information:

- Service number and name
- Transmitting satellite
- Transponder information

A dollar sign (\$) may be marked on some entries, indicating pay service. To watch pay services, you need the subscription card.

To select a desired service, put the highlight bar on its entry with the (P+) or (P-) button and press the (OK) button; then it will be presented.

Pressing the (V-) or (V+) button skips over 10 entries up or down. Entering a service number with the numeric buttons puts the highlight bar on its entry.

Pressing the (F3) button performs an alphabetic browse. For instance, when the highlight bar is on an entry of which initial is B, pressing the (F3) button puts the highlight bar on the first entry of which initial is C.

To sort the services list by service name, press the (F2) button. Pressing this button once more makes it sorted by service number.

Pressing the (F4) button displays the additional options, with which you can do the following:

- Select your desired satellite at the Satellite option, then only services provided by the selected satellite will be listed.
- By setting the Show Provider option to On, you can view the provider of the services, which is usually the name

of the television company responsible for broadcasting them.

- To change the name of the highlighted service, select the **Rename** option; then the on-screen keyboard appears, with which you can enter a new name. See § 6.3 for how to use the on-screen keyboard.
- You can prevent other family members from watching the highlighted service by setting the **Lock** option to **Locked**. You have to enter your personal identification number to watch or unlock it.
- To delete the highlighted service, select the **Delete** option; then you are asked for confirmation. If you select **Yes**, it will be deleted. If you want to restore it as before, you have to perform service search again. See § 4.1.4 for service search.
- To add the highlighted service into a favourite group, select the **Add to Fav** option; then the favourite groups will be displayed. Put the highlight bar on a desired group and press the **OK** button.
- You can additionally sort the services list with the **Sorting** option as follows:
 - Default by service number
 - Alphabetic by service name
 - Satellite by satellite
 - FTA–CAS from free services to pay services
 - CAS–FTA from pay services to free services
 - Provider by service provider
 - Fav–NoFav from favourite services to unfavourite services.

Pressing the **SAT** button displays the satellite list. Once you select a desired satellite in the satellite list, only services provided by the selected satellite are listed.

You can switch between the television services list and the radio services list by pressing the **(M)** button.

5.2.2 The favourite services list

You can select a service to watch on a favourite list as well as on the services list.



To display the favourite lists, press the **(FAV)** button; it will be displayed. As you move the highlight bar up or down on the favourite group list, favourite services belonging to the highlighted group are listed.

For how to edit the favourite lists, refer to § 6.2.

To select a favourite service, put the highlight bar on a desired group and press the **(V+)** button; a highlight bar appears on the favourite services list. Once you select a desired service with the **(OK)** button, it will be presented. Otherwise, to select other group, press the **(V-)** button.

After you have selected a favourite service, if you then switch to another service using the **(P+)** or **(P-)** button, it will be also another favourite service of the selected group. The digital receiver will remind you what group you have selected by displaying its name at the top right of the screen whenever you switch services. If you wish to get out of the current group, select the **All services** group on the favourite list.

Besides that, you can add or delete a favourite group or service. To add a service you are watching currently in a favourite group, put the highlight bar of the group list on a desired group and press the **(F3)** button. To create a new group, press the **(F2)** button. To delete a group or a service, press the **(F4)** button.

5.2.3 Viewing programme information

Pressing **(i)** button displays the information box, on which you can see all of the following:



- Service number and name
- Transmitting satellite
- Transponder information
- Signal level and quality
- Programme name
- Programme classification symbol
- Programme summary
- Broadcasting time
- Current time



In addition, you might see the following symbols:

- Subtitle symbol (**[]**) if subtitle tracks are provided on the current programme.
- Teletext symbol (**[≡]**) if teletext pages are provided on the current service.
- Lock symbol (**[🔒]**) if the current service is locked.
- Dollar symbol (**(\$)**) if the current service is a pay service.
- Multifeed symbol (**[📺]**) if the current programme is provided in a multifeed service. To use this feature, refer to § 5.4.



If the electronic programme guide is provided on the current service, you can see the information about the next programmes with the **(V-)** or **(V+)** button. To adjust the sound volume in this case, press the **(V-)** or **(V+)** button continuously until the sound bar appears and reaches your desired level.

Pressing the **(i)** button once more displays detailed information about the current programme. To hide the information box, press the **(EXIT)** button.



5.2.4 Selecting audio tracks



Some programmes are provided with audio tracks in one or more languages. Pressing the  button displays available audio tracks. Once you select an audio track, it will be sounded. In addition, you can enjoy audio tracks in four sound modes: Stereo, Mono, Left or Right. However, if a multifeed programme is provided at the moment, video tracks will be displayed. In this case, you have to press the  button once more to select an audio track.

5.2.5 Selecting subtitle tracks

Some programmes are provided with subtitle tracks in one or more languages. If the current programme provides subtitle tracks, the subtitle symbol () will be marked on the information box. Pressing the  button displays available subtitle tracks. Once you select a subtitle track, it will be displayed.

5.2.6 Viewing teletext

On some services, such information as weather reports, news or stock quotations is provided by means of teletext. If the current service provides teletext, the teletext symbol () will be displayed on the information box. Press the  button to view teletext pages.

Select a desired page to view by entering the page number with the numeric buttons. You can zoom into a teletext page with the  button, and adjust its transparency with the  button. To hide the teletext screen, press the  button.

5.3 Viewing electronic programme guide

The Electronic programme Guide shows the current and scheduled programmes that are or will be available on each service with a short summary for each programme.



Pressing the **(GUIDE)** button displays the electronic programme guide, on which you can see the following:

- Scheduled programmes
- programme summary
- Broadcasting date
- Broadcasting time

To see detailed information of a desired programme, put the highlight bar on your choice with the **(P+)** or **(P-)** button and press the **(Z)** button. To switch to another service, press the **(V-)** or **(V+)** button. You can travel over previous days with the **(F2)** button, and can travel over next days with the **(F3)** button.

To see the programme guide for radio broadcasts, press the **(c/r)** button. To switch it back, press the **(c/r)** button again.

Pressing the **(F1)** button displays the programme guide in the form of a spreadsheet. To switch it back, press the **(F1)** button again.

You can make a timer event on the electronic programme guide as follows:

1. Select a service you want.
2. Press the **(GUIDE)** button to display its programme guide.
3. Select a programme you want with the **(OK)** button, then **P** is marked up on the entry. At the same time, a timer event with the selected programme will be made in the timer list. Refer the timer list to § 5.5.
4. To remove the marking, press the **(OK)** button once again.

5.4 Watching multifeed programme

Some broadcasts such as sports channels can provide a variety of perspectives on a programme at the same time. We call it a multifeed programme. You can select and watch a perspective you prefer.

If a multifeed programme is provided on the current service, the multifeed symbol (⊞) will be marked on the information box. Press the **47** button, then available video tracks will be listed. Once you select one, it will be presented. At this time, you have to press the **47** button once more to select audio tracks.

5.5 Making timer events

You can make the digital receiver to present your desired service at a specific time. Even if the digital receiver is off, it will turn on at the specified time.

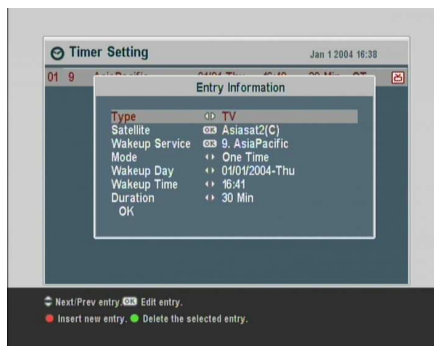

To input a timer recording, select the Timer Setting menu; then the timer list will be displayed.

To add a new timer event, press the **F1** button, and a box like the left figure appears. Take the following steps:

1. If you want a radio programme, set the Type option to Radio; otherwise, set it to TV.
2. Set the Satellite option to the satellite which transmits the service you want. Pressing the **OK** button on this option displays a satellite list, from which you can select your desired satellite.

3. Set the **Wakeup Service** option to the service which provides the programme you want. Pressing the **(OK)** button on this option displays a services list, from which you can select your desired service.
4. There are five timer modes:
 - One Time** means literally 'one time.'
 - Every Day** means literally 'every day.'
 - Every Weekend** means 'Saturday and Sunday every week.'
 - Weekly** means 'one day every week.'
 - Every Weekday** means 'from Monday to Friday every week.'

If your favourite programme is broadcasted at weekends and you wish to watch every episode of the programme, set the **Mode** option to **Every Weekend**.

5. Set the **Wakeup Day** option to a desired date, on which the digital receiver will turn on. The date format is *day/month/year-day of the week*.
Set the **Wakeup Time** option to a desired time, at which the digital receiver will turn on. The time format is *hour:minute*.
6. Set the **Duration** option to a desired time, in which the digital receiver will turn off.
7. To set a timer event with the above settings, select the **OK** option; otherwise, it will not be made.

To delete a timer event, put the highlight bar on the entry you want to remove and press the **(F2)** button; then you are asked for confirmation. If you select **Yes**, it will be deleted.

Chapter 6

Listing Services

6.1 Editing the services list

You would have got the services list after service search. You can rename, move, lock or delete service entries on the services list.

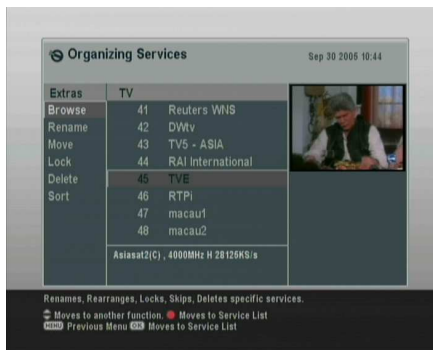

Select the Organizing Svc/Fav > Organizing Services menu. You should see a screen like the left figure.



There are editing options on the left column and service entries on the right column.



Once you put the highlight bar on a desired option on the left column and press the **OK** button, you can select a desired service to edit on the right column. To go over to the other column, press the **F1** button.

To edit the radio services list, press  button; then radio service entries will be listed on the right column. To switch back to the television services list, press it again.

To change the name of a service, select the **Rename** and select a desired service; then the on-screen keyboard appears. See § 6.3 for how to use the on-screen keyboard.

Unlike analogue broadcasts, each service does not have a proper service number in digital broadcasts. Service numbers are just assigned to the services in the order that they were found in the service search. So you can reassign a service number by moving a service entry. To move a service entry, select the **Move** option and select a desired service; then the selected service becomes darker. As you move it up or down, it gets renumbered according to the position. Press the  button to fix it.

You can lock some services to prevent your children from watching them. To lock a service, select the **Lock** option and select a desired service; then a lock symbol  will be marked on the selected service. If anyone tries to watch a locked service, the person has to enter the personal identification number that is set to the **Change PIN Code** option. See § 3.4 for this option. To unlock a locked service, press the  button on it.

To delete a service, select the **Delete** option and select a desired service with the  button, and then press the  button; you will be asked for confirmation. If you select **Yes**, the selected service will be deleted. If you want to undo the deleted service, there is nothing you can do but perform a service search again.

Once you select the **Sort** option on the left column, sorting options are displayed as follows:

Default by service number

Alphabetic by service name

Satellite by satellite

- FTA–CAS from free services to pay services
- CAS–FTA from pay services to free services
- Provider by service provider
- Fav–NoFav from favourite services to unfavourite services.
- Transponder by transponder

6.2 Editing the favourite list

You can make your own favourite services list. In fact, you can define multiple favourite services lists, each being a ‘group’ of chosen services.

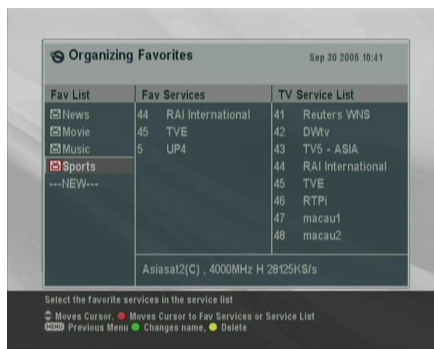

Select the Organizing Svc/Fav > Organizing Favorites menu. You should see a screen like the left figure.

There are 3 columns:

- Group list (left)
- Favourite list (centre)
- Services list (right)

The services list contains all available services, whereas the favourite list contains only chosen services that have been added to the highlighted group. As you move the highlight bar up or down on the group list, favourite services belonging to the highlighted group are shown in the favourite list.

You can add up to 30 groups. To add a group, select the NEW option in the group list; then the on-screen keyboard appears. See § 6.3 for how to use the on-screen keyboard.

To rename a group, put the highlight bar on a desired group you wish to rename and press the **F2** button; then the on-screen keyboard appears. See § 6.3 for how to use the on-screen keyboard.

To delete a group, put the highlight bar on a desired group you wish to delete and press the **F3** button; then a confirmation box appears. If you select **Yes**, it will be deleted.

You can add a favourite service to a group by performing the following steps:

1. Put the highlight bar on a desired group entry in the group list and press the **OK** button to select it. The highlight bar then moves to the services list.
2. To add a service to the selected group, put the highlight bar on a desired service entry and press the **OK** button. The selected service entry is added to the favourite list. Repeat this step to add more entries.
3. Press the **F1** button and the highlight bar is moved to the favourite list. You can delete a favourite entry with the **OK** button.
4. To select another group, press the **F1** button again. By pressing the **F1** button, the highlight bar is moved to each column.

To add radio services, press the **Ⓜ** button; then radio service entries will be listed in the services list. To recall the television services list after adding radio services, press the **Ⓜ** button again.

With your favourite services list, you can select your favourite services more easily. Refer to § 5.2.2 for more information.

6.3 How to use on-screen keyboard



You can move the highlight key horizontally with the **(V-)** and **(V+)** buttons and vertically with the **(P+)** and **(P-)** buttons. Pressing the **(OK)** button on a key enters its letter in the input line. To type a space, select the **Space** key. To type lower case letters or numerals, select the **Other** key.

To delete a letter, put the cursor on a desired letter at the input line and then select the **Del** key. You must select the **Save** key to complete naming; otherwise, if you press the **(EXIT)** button, it will not be named.

6.4 Transferring receiver data

The digital receiver retains such data as follows:

- Services list
- Favourite lists
- Preference settings

It is possible to transfer receiver data to your digital receiver from another same digital by receiver connecting them with a RS-232 cable.

To transfer receiver data, perform the following steps:

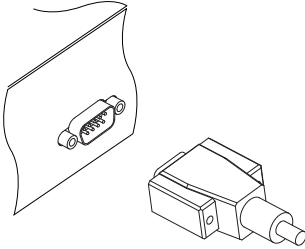

1. Plug one end of a RS-232 cable (9 pin D-sub cable) into the RS-232 port on the digital receiver, and the other end into the matching port on the other digital receiver.
2. turn on the source digital receiver.
3. Select the Installation > Transfer Firmware > Transfer Data to Other IRD menu.
4. To start the data transfer, turn on the target digital receiver.

NOTE

You had better memorize some important data such as video settings before starting transfer to avoid losing them.

Chapter 7

Firmware Update

The digital receiver has a stable and convenient firmware to use. However, a new firmware may be released to improve the digital receiver. You can get the latest firmware and an update utility from the web site, <http://www.i-topfield.com>.



You have to check the firmware information of your digital receiver before downloading a new firmware. Select the Information > IRD Status menu. You should see a screen like the left figure.

NOTE

You can only update with new firmware of which System ID is identical to yours. Otherwise you will fail in firmware update.

7.1 From a USB storage

If you have a USB storage, you can update the firmware from it. To update the firmware from your USB storage, perform the following steps:

1. Download a new firmware from the Topfield web site.
2. Copy the firmware file to your USB storage.
3. Insert the USB storage into the USB port on the digital receiver.
4. Select the Installation > USB Firmware Upgrade menu, then the files in the USB storage are listed.
5. Place the highlight bar on the right firmware file and press the **OK** button, then a countdown will be displayed on the front of the digital receiver.
6. When 'END' message appears, restart the digital receiver.

NOTE

Your USB storage must be formatted in the FAT file system. If not, the digital receiver cannot recognize your USB storage. In addition, the digital receiver can only recognize files and directories which are named with only alphabetic, numeric and underscore letters. If there is a file or folder named with other letters, the digital receiver cannot recognize not only it but also the subsequent files and folders.

7.2 From your computer via RS-232 port

It is possible to transfer a new firmware to the digital receiver from your computer by connecting them with a RS-232 cable. You need *TFD-Down*, a firmware transfer utility for this, which is available from the web site, <http://www.i-topfield.com>.

To update the firmware with this method, perform the following steps:

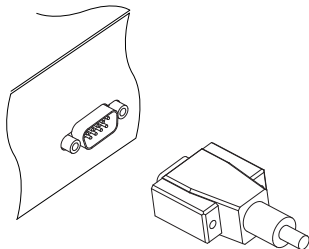

1. Download a new firmware applicable to the digital receiver from the Topfield web site.
2. Turn off the digital receiver.
3. Plug one end of a RS-232 cable (9 pin D-sub cable) into the RS-232 port on the digital receiver, and the other end into the matching port on your computer.
4. Run *TFD-Down*.

The instructions on how to use *TFD-Down* are as follows:



1. Press the Find button to select the new firmware file.
2. Press the Download button.
3. To start the file transfer, turn on the digital receiver.
4. When the file transfer is complete, the display panel on the digital receiver will count down to zero while the new firmware is being applied.
5. Restart the digital receiver.

7.3 From another digital receiver via RS-232 port

It is possible to transfer a new firmware to the digital receiver from another same digital receiver by connecting them with a RS-232 cable.

To update the firmware with this method, perform the following steps:

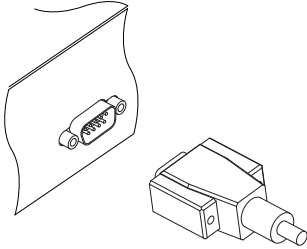

1. Turn off the target digital receiver.
2. Plug one end of a RS-232 cable (9 pin D-sub cable) into the RS-232 port on the digital receiver, and the other end into the matching port on the other digital receiver.
3. If not already on, turn on the source digital receiver.
4. Select the Installation > Transfer Firmware > Transfer Firmware to Other IRD menu.
5. To start the file transfer, turn on the target digital receiver.
6. When the file transfer is complete, the display panel on the digital receiver will count down to zero while the new firmware is begin applied.

Index

- 16:9, [17](#)
- 16:9 Display Format, [18](#)
- 22 kHz, [26](#)
- 4:3, [17](#)

- A/V Output Setting, [16](#)
- Access Control, [23](#)
- Add new TP, [32](#)
- Add Satellite, [32](#)
- Add to Fav, [37](#)
- Advanced, [30](#)
- AUDIO L, [13](#)
- Audio Language, [16](#)
- AUDIO R, [13](#)
- Auto, [30](#)

- Button, [4](#)

- C band, [24](#)
- CAM, [5](#)
- CAS, [31](#)
- CAS only, [31](#)
- Censorship, [22](#)
- Center extract, [18](#)
- Change PIN Code, [22](#)
- CI, [5](#)
- Common Interface, [6](#)

- Daylight Saving Time, [21](#)
- Delete, [37, 45](#)
- Delete Satellite, [32](#)
- Delete TP, [32](#)

- DiSEqC, [26](#)
- DiSEqC 1.0, [26](#)
- DiSEqC 1.1, [26](#)
- DiSEqC Command Mode, [27](#)
- Dolby Digital, [19](#)
- Download, [52](#)
- Duration, [43](#)
- DVB, [1](#)
- DVB-S2 8PSK, [30](#)
- DVB-S2 QPSK, [30](#)

- Electronic programme Guide, [40](#)

- Factory Setting, [33](#)
- FEC, [30](#)
- Find, [52](#)
- Frequency, [27, 29–32](#)
- FTA, [31](#)
- FTA + CAS, [31](#)
- FTA only, [31](#)
- FTA/Scrambled, [31](#)

- GMT, [20](#)
- GMT Collection, [20](#)
- Goto, [27](#)
- Goto the position, [29](#)

- HDMI, [11, 18](#)
- high definition, [18](#)

- Info Box Display Time, [23](#)
- Info Box Position, [23](#)

- information box, 39
- IRD Status, 50

- K_u band, 25
- keyboard, 48

- Language Setting, 15
- Letter Box, 18
- LNB, 25
- LNB Frequency, 25, 26
- LNB IN, 11
- LNB OUT, 11
- LNB Power, 26
- LNB Setting, 25
- Local Time, 20
- Lock, 37, 45

- Manual, 30
- Menu Language, 15
- Mini A, 26
- Mode, 20, 43
- Modulation, 30
- mono, 19
- Motor Control, 27, 28
- Motorized DiSEqC 1.2, 27
- Motorized DiSEqC 1.3, 28
- Move, 29, 45
- Movement, 27
- multifeed, 42
- My Latitude, 28
- My Longitude, 28

- NEW, 46
- No block, 22
- normal-screen television, 17

- on-screen keyboard, 46
- Organizing Favorites, 46
- Organizing Services, 44
- OSD Transparency, 23
- Other, 25

- Parental Control, 22
- PID, 31
- PID, 31

- Pilot, 30
- PIN, 22
- Polarization, 30, 31

- Radio, 42
- radio services list, 45
- Recover, 33
- Rename, 37, 45
- RS-232, 49, 52, 53

- S/PDIF, 19
- S/PIDF, 13
- SAT Name Edit, 32
- SAT/TP Edit, 32
- Satellite, 20, 36, 42
- Satellite Angle, 29
- satellite list, 25, 37
- Satellite Name, 25–28, 30–32
- SCART, 18
- SCART Output, 16
- Search Mode, 30, 31
- Service Search, 29
- services list, 35
- Show Provider, 36
- SMATV, 29
- SMATV, 31
- Sort, 45
- Sorting, 37
- Sound Mode, 19
- Space, 48
- specifications, 8, 10
- Start Search, 31
- stereo, 19
- Store, 28, 33
- subtitle, 40
- Subtitle Language, 16
- Symbol Rate, 30, 31
- System ID, 50
- System Recovery, 33
- System Setting, 23

- teletext, 40
- television services list, 45
- TFD-Down, 51, 52
- time format, 20

Time Offset, [20](#)
Time Setting, [20](#), [23](#)
timer list, [42](#)
Timer Setting, [42](#)
Total block, [22](#)
Transfer Data to Other IRD, [49](#)
Transfer Firmware to Other IRD, [53](#)
Transponder, [20](#), [27](#), [29](#)
transponder, [1](#)
TV, [12](#), [18](#), [19](#), [42](#)
TV Aspect Ratio, [17](#)
Type, [42](#)

USALS, [28](#)
USALS Setting, [28](#)
USB, [51](#)
USB Firmware Upgrade, [51](#)
User, [27](#)

VCR, [14](#)
VCR Scart Type, [17](#)
VIDEO, [11](#), [13](#), [19](#)
Video Format, [18](#)

Wakeup Day, [43](#)
Wakeup Service, [43](#)
Wakeup Time, [43](#)
wide-screen television, [17](#)

YPbPr, [18](#)



Correct disposal of this product

This marking shown on the product or its literature indicates that it should not be disposed with other household wastes at the end of its working life.

To prevent possible harm to the environment or human health from uncontrolled waste disposal, please separate this from other types of wastes and recycle it responsibly to promote the sustainable reuse of material resources.

Household users should contact either the retailer where they purchased this product or their local government office for details of where and how they can dispose this product for environmentally safe recycling.

Business users should contact their supplier and check the terms and conditions of the purchase contract. This product should not be mixed with other commercial wastes for disposal.

Topfield continues to improve the digital receiver which this guide explains. So some explanations and illustrations in this guide could be different from the actual digital receiver.