

User Manual	3
Bruksanvisning	21
Käyttäjän opas	39
Betjeningsvejledning	57

Thank you for choosing Philips.

Need help fast?

Read your User's Manual first for quick tips that make using your Philips product more enjoyable.

If you have read your instructions and still need assistance, you may access our online help at www.philips.com/support or call our **Philips Consumer Care helpline** to be found on the next page



PHILIPS

Contents

Quick Start Guide 4
 Connecting to a Television 4
 Connecting to a Television and Recorder 4

Introduction 5
 About This User Manual 5
 Safety and Precautions 5
 Batteries 6
 Miscellaneous notes 6
Environmental Markings 6

Getting Started 7
 In the Box 7
Identification of Parts 7
 Remote Control 7
 Digital Set Top Box 8
 Mains Adaptor 8
The Remote Control 8
 Using the Remote Control 8
Mains adaptor 8
Connecting Your Digital Set Top Box to other equipment 9
 Connecting to a Television and DVD player 9
 Connecting to a TV and audio equipment 9

Operation 10
Switch-on/switch-off 10
Initial installation 10
Change of channel 11
Volume control 11
 Mute function 11
Calling up information banner 11
Using options 11
Using teletext 12
Using channel list 12
Creating and Editing channel list 13
 Defining channels as your favourites 13
 Shifting channels in the favourite list 13
 Deleting channels in the favourite list 13

Extended installation 13
 Automatic scan mode 13
 Expert scan mode 14
EPG 14
Timer 15
 Adding programme to timer list 15
 Editing timer list 15
 Deleting (a) programme(s) 15
 Timer editing 15
 Switching off current timer functions 15
Miscellaneous functions 16
 Restoring default settings 16
 Displaying channel and system information / adjusting the antenna 16
 Displaying the time 16
 Switching between set top box and TV 16
 Carrying out software update 16
Radio 16
Settings 17
 Picture settings 17
 Language 17
 Menu settings 17
 General 18
 Calling up default settings 18
Security 18
 PIN lock 18
 Menu lock 18
 Protection of minors 18
 Changing device PIN 18

Troubleshooting 19
 Symptom 19
 Possible cause 19
 Remedy 19

Technical Data 20

Country	Phillips Consumer Care no.	Remarks
Czech Republik	800 142 840	
Denmark	3525 8759	
Finland	09 2311 3415	
France	08 9165 0005	0.23 euros/min
Gerrmany	0180 5 356 767	0.12 euros/min
Spain	902 888 784	0.15 euros/min
Sweden	08 5792 9100	

Quick Start Guide

Connecting to a Television

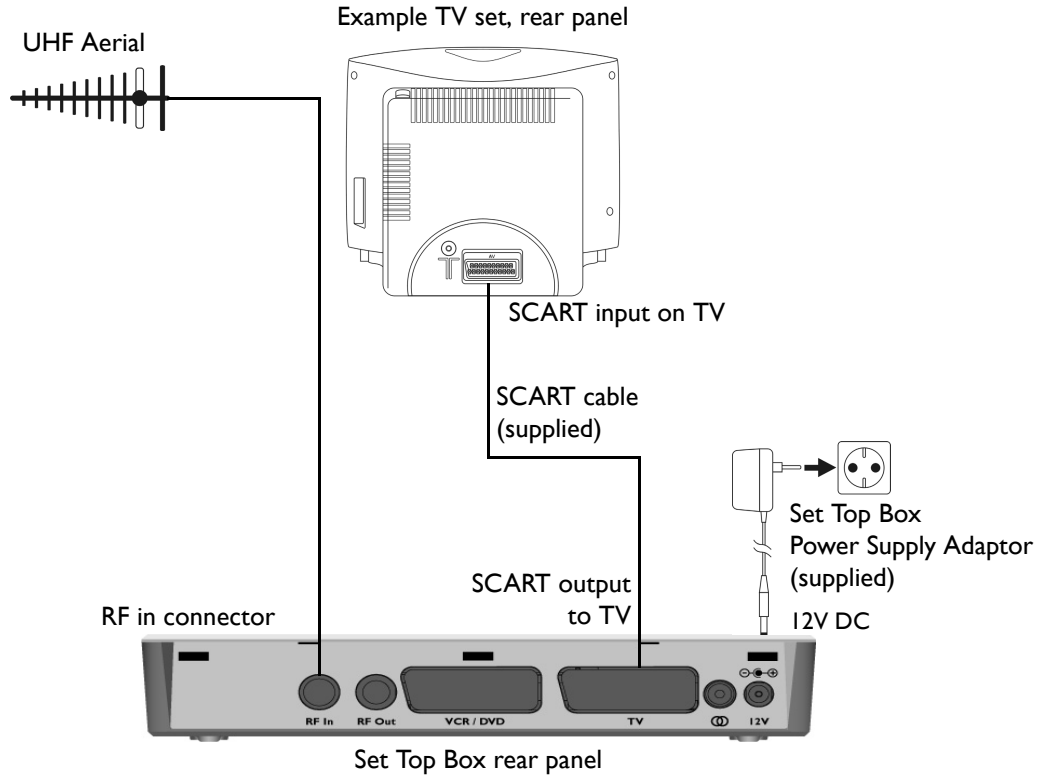

Connecting to a Television and Recorder

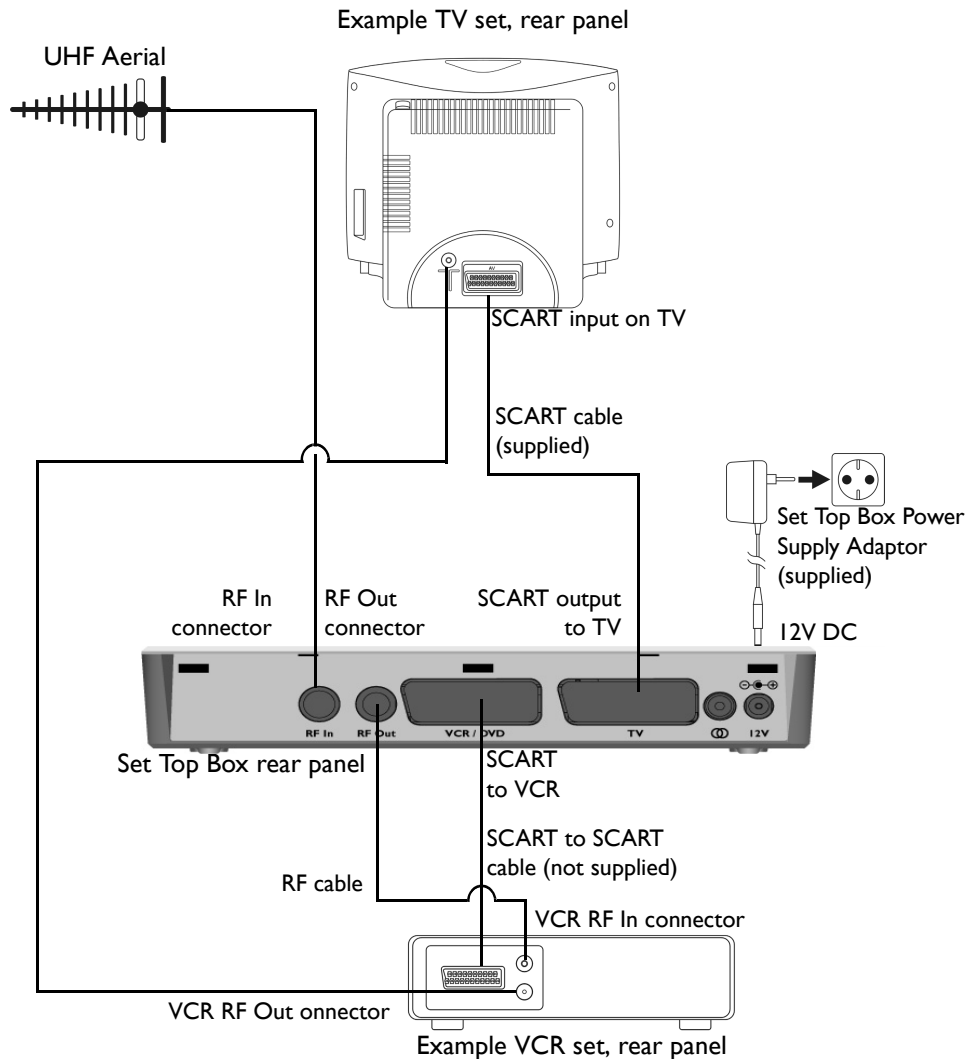

Thank you for purchasing this product which has been designed and manufactured to give you many years of trouble-free service.

About This User Manual

This user guide contains all the information you need to know about how to setup and watch available 'Freeview' channels using your set top box.

Safety and Precautions

Safety is Important

To ensure your safety and the safety of others, please ensure you read the Safety Instructions before you operate this product.

Note: Keep this information in a safe place for future reference.

Safety warnings

Before you connect and start the receiver, please observe the following points:

- The device is designed for domestic use.
- Only the functions described in these Operating Instructions may be carried out with this device.
- If possible, keep the Operating Instructions ready at hand near the appliance.
- If you hand the device on to other persons, please also include these Operating Instructions.

Danger caused by electricity

- In the interior of the device there are hazardous voltages. Never open the housing or insert objects through the ventilation openings.
- Only connect the device to a 230 V power outlet installed according to regulations, being accordingly fused.
- The power outlet has to be easily accessible so that you are able to disconnect the power plug immediately if necessary.
- Observe that the connector cables are not clamped or squeezed.
- Do not start the device if the device or the connector cables show visible damage, or if the device has fallen down.
- If an apparent damage occurs (e. g. smoke or similar) during operation, immediately disconnect the pluggable power supply from the power outlet. In doing so, always take hold of the plug, never of the cable.

- Power outlets and extension cables may not be overloaded, otherwise there is fire hazard! When purchasing the product, enquire for the maximum permissible current consumption.
- In order to completely disconnect the device from the power supply, the pluggable power supply has to be disconnected from the power outlet.
- Have repairs or settings on your receiver carried out by qualified skilled personnel only. Unauthorised opening and repair attempts will result in loss of warranty. The manufacturer accepts no liability for accidents of the user if the device is opened. Incorrect wiring of the connections can result in failures or malfunctions on the device.
- Do not effect modifications on this device.
- Use provided cables and pluggable power supplies only.
- During thunderstorms, devices connected to the mains supply may be damaged. Therefore, in case of a thunderstorm always disconnect the pluggable power supply from the power outlet.
- If you are absent for a longer period of time or during a thunderstorm, disconnect the receiver from the power supply unit and from the antenna. This also applies to devices connected to the receiver.

Danger of electric shock by humidity

- The device may not be exposed to dripping or splashing water. Prevent liquids from entering into the device. In case of need, immediately disconnect the power plug.
- The device may not be used in damp locations (e. g. bathroom) or rooms with heavy dust accumulation.
- Objects filled with water, e.g. vases, may not be placed on the device.

Danger of injuries by other causes

- Observe that nobody can trip over the connector cables.

Dangers for children

- Never leave children unattended with this device. Children underestimate the danger associated with electric appliances.

Notes with regard to the installation location

- Install device on horizontal surface only.
- Do not expose this device to extreme temperatures. Therefore:
 - Avoid direct solar radiation and radiator heat;
 - Do not obstruct the air ventilation by covering the ventilation openings with objects, like for example magazines, table cloths, curtains, etc.;

- Leave a minimum clearance of approx. 40 cm above and to the sides. The heat may not accumulate in the device! Otherwise the heat can damage the device, and there is fire hazard!

- The device may not be installed close to inflammable material (e. g. curtains, flammable liquids, etc.).

Batteries

- Batteries are to be kept away from children.
- After swallowing a button cell or battery, the person concerned has to consult a doctor immediately.
- Do not try to reactivate used batteries by heat, charging, or by other means.
- Batteries may not be thrown into the fire, disassembled, or short-circuited.
- Replace the batteries at least one a year to prevent them from leaking.
- Always replace both batteries and use batteries of the same type only (e. g. alkaline cells or zinc/carbon).
- If you are absent for a longer time, remove the batteries from the RC unit.

Miscellaneous notes

- Do not place open fire sources, like for example burning candles, on the device.
- The antenna that is used has to be grounded.
- Only switch the device on after the connections with the antenna and the SCART cable have been established.
- The bottom side of the device features the device feet. Because the furniture or floor surfaces consist of various materials and are treated with various care products, it cannot be completely ruled out that some of these materials contain components affecting and moistening the feet of the device. If required, place a non-slip mat underneath the feet.
- Opening the device results in loss of warranty.

This symbol indicates that the adapter is a Class II appliance and does not require an earth connection.



This symbol indicates that the adapter is for indoor use only.



This symbol indicates that the adapter conforms to CE regulations.



Environmental Markings



Your product has been designed and manufactured with high quality materials and components, which can be recycled and reused.

When this crossed-out wheeled bin symbol is attached to a product or his packaging, it means the product is covered by European Directive 2002/96/EC.

Please inform yourself about the local separate collection system for electronic products.

Please act according to your local rules and do not dispose of your old products with your normal household waste. The correct disposal of your old product will help prevent potential negative consequences for the environment and human health.



The "Material recyclability symbol " affixed on package cardboard and user manual means these parts are recyclable. So do not dispose of them with your normal household waste.



The "Material recyclability symbol " affixed on plastic packaging parts means these parts are recyclable. So do not dispose of them with your normal household waste.



The "Green Dot" affixed on cardboard means PHILIPS pays a financial duty to the "Avoidance and Recovery of Packaging Waste" organization.

Getting Started

Remove your Digital Set Top Box carefully from the box, and remove the packaging from each part.

In the Box

You will find the following items:

- Digital Set Top Box
- Remote Control (AA batteries)
- Power supply 230 V AC/50 Hz to 12 V DC
- SCART-to-SCART cable
(for Digital Set Top Box to SCART input connector on TV set)
- User Manual (This publication)

If any of these items are damaged or missing, please contact us at the Philips Consumer Care helpline found on page 3.

Please make sure that you have the model number of your set top box, before contacting us. The label showing the type and serial number is underneath your receiver.

Identification of Parts

Remote Control

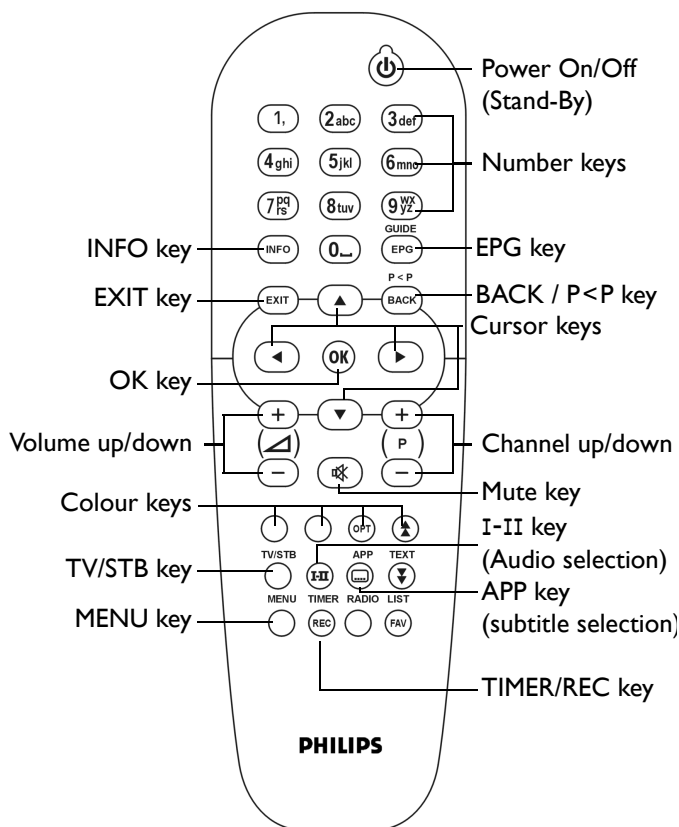

Batteries are removable from the remote using common household tools (like a screwdriver...)

The batteries supplied do not contain hazardous substances such as Mercury, Cadmium, or Lead.

However, they must not be disposed of with your household waste but to a local separate collection system.

Digital Set Top Box

Front view

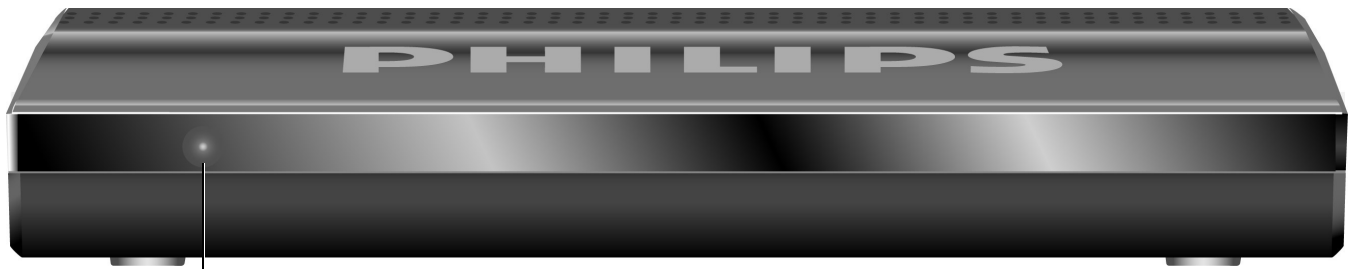

IR Receiver / Red LED, Normal Operation - off, Standby - on

Rear view

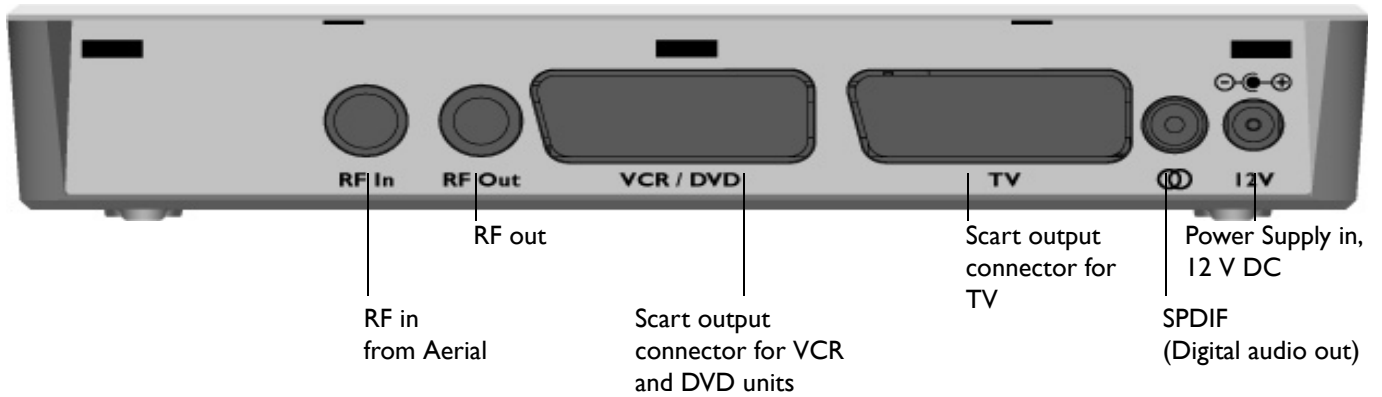

Mains Adaptor

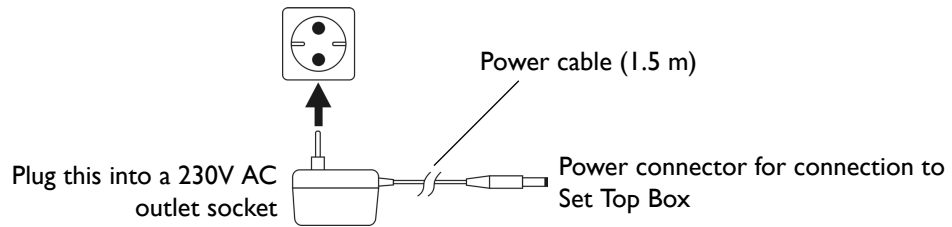

The Remote Control

Using the Remote Control

To use the remote control, point it towards the front of the set top box.

The remote control will not operate if its path is blocked.

Warning:
Sunlight or very bright light will decrease the sensitivity of the remote control.

Note that the only recommended way to disconnect the Digital Set Top Box from the mains supply is to remove the adaptor from the mains socket. If the mains socket is fitted with a switch, this could be used instead.

Mains adaptor

A mains power adaptor has been supplied for powering this equipment. It has an integral cable terminated in a power connector to plug directly into the 12V connector on the back of the Digital Set Top Box. The adaptor is shown on the right.

Plug the cable into the 12V DC connector on the rear panel. Insert the adaptor body into a suitable mains outlet socket.

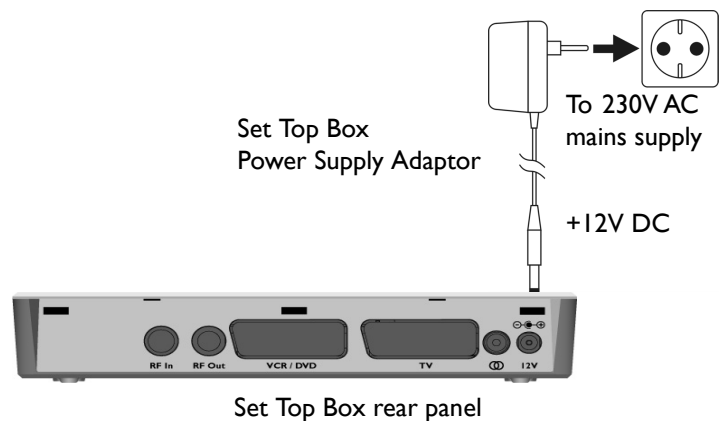

Connecting Your Digital Set Top Box to other equipment

The following diagrams are of typical configurations only, and may differ slightly to your existing external equipment. If you are unsure on how to connect to your set top box, always consult your manufacturer's user guide supplied with your equipment.

Connecting to a Television and DVD player

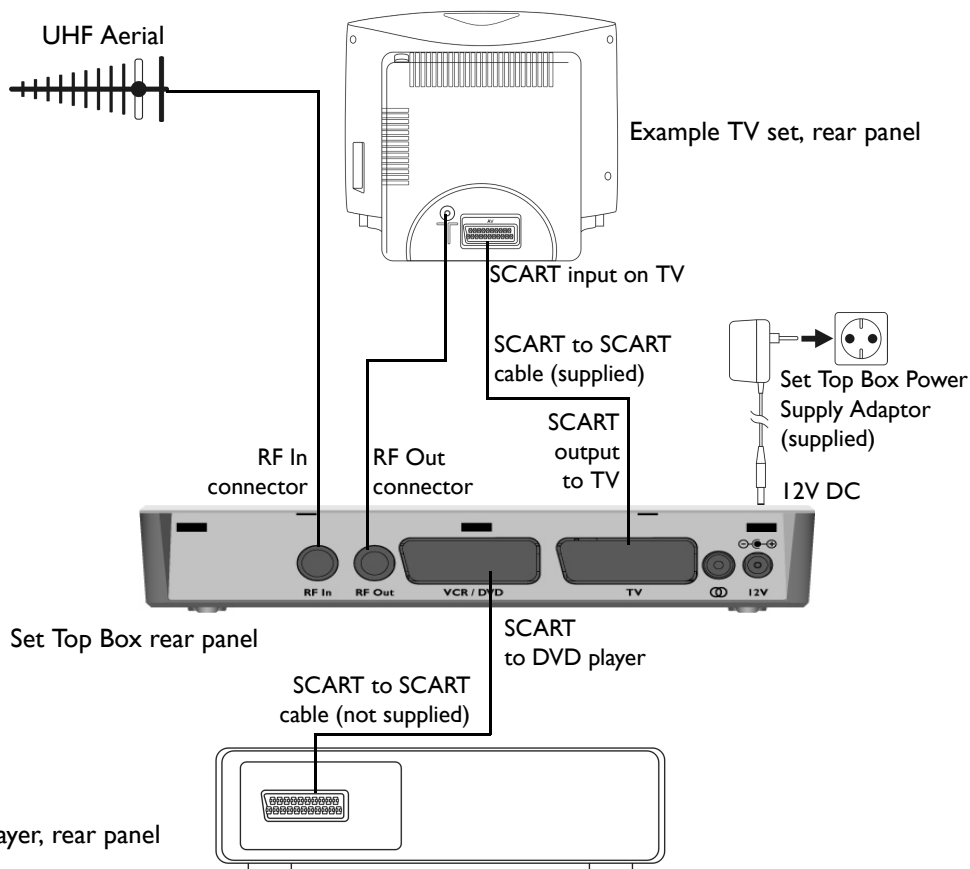

If you decide to connect a DVD player or recorder to the VCR Scart of your digital receiver, we advise to set the DVD output format to CVBS or PAL. Refer to the user manual of your DVD player or recorder.

You can use a S/Pdif connector to connect your Set Top Box to a digital sound input device, such as a receiver.

Connecting to a TV and audio equipment

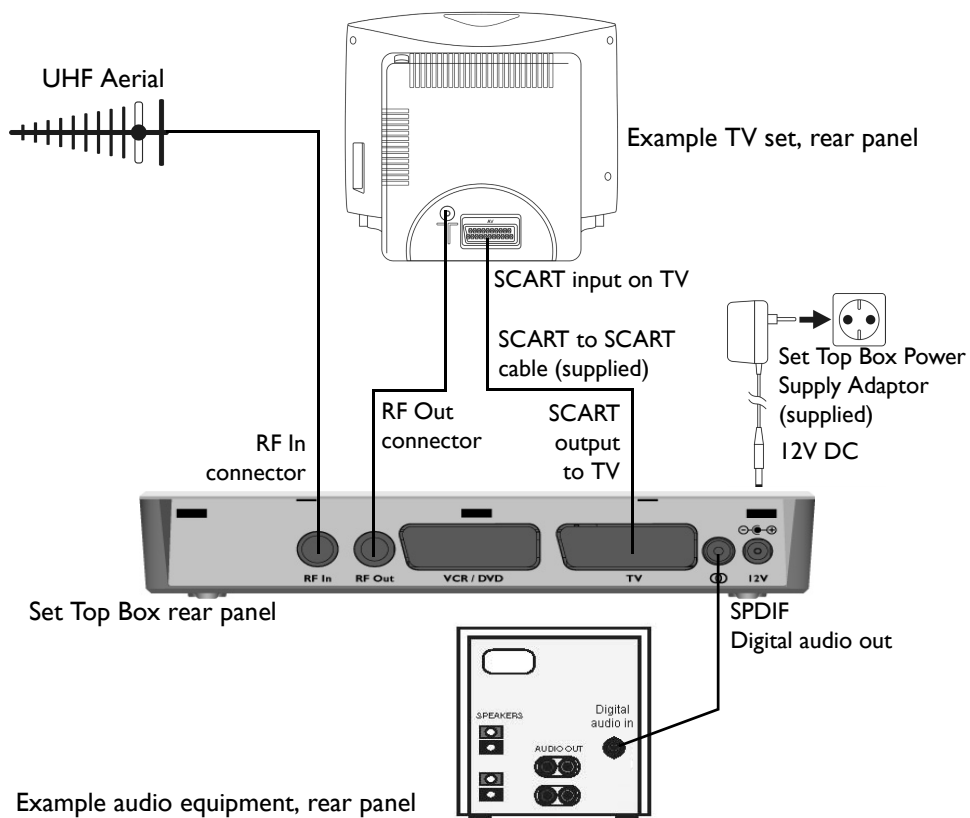

Switch-on/switch-off

Switch the receiver on by pressing the **ON/OFF** button (standby button) on the remote control and wait until you see the welcome image on your screen.

The LED is off if the receiver is switched on.

When you switch on your receiver for the first time, the LED is blinking while the software is loading. Follow the steps explained in the section Initial installation on this page.

When the receiver is in stand-by mode the LED is red.

During a software update process the LED is blinking.

Initial installation

After the first switch-on, you'll receive the following welcome window:

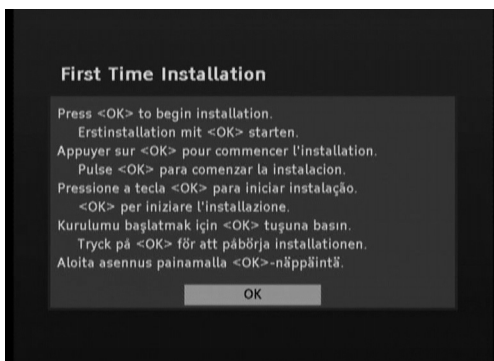

- 1 Press the **OK** button to proceed to the next page.
- 2 On the next page, select the desired language by pressing the **arrow** button **◀** or **▶**, and again press the **OK** button.

The **settings** window is displayed:

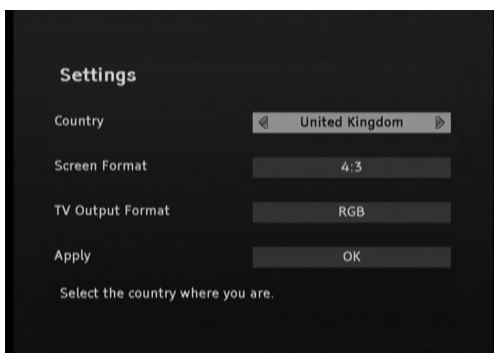

Note: Also observe the information messages displayed on the screen. These will help you to set the correct values. Also with regard to further operation, information messages are displayed.

- 3 Now successively set the desired values. In doing so, observe the following:

- By using the **arrow** buttons **◀** or **▶**, you change the displayed values,
 - By using the **arrow** buttons **▲** or **▼**, you switch between the individual setting possibilities.
- 4 Then highlight the **OK** field by using the **arrow** button **▲** or **▼** behind **adopt**, and press the **OK** button.

The next window is displayed:

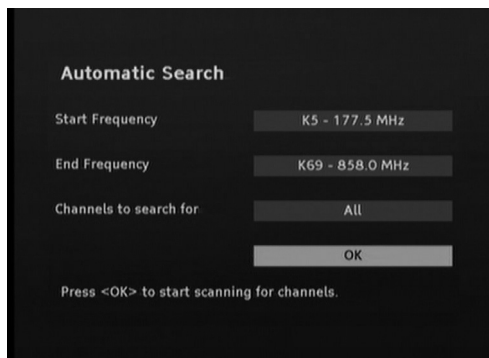

Note: The displayed values for the start and stop frequency can normally be maintained.

- 5 If desired, change the values for the start and stop frequency by using the **arrow** buttons **◀** or **▶**.
- 6 By means of the **arrow** buttons **◀** or **▶**, you define the channels to be selected: **all channels**, or channels that are **free-to-air only**.
- 7 Then highlight the **OK** field by using the **arrow** button **▲** or **▼** next to **start scan mode**, and press the **OK** button.

The scan mode is started. The screen dialog thereby provides information on the progress of the channel search.

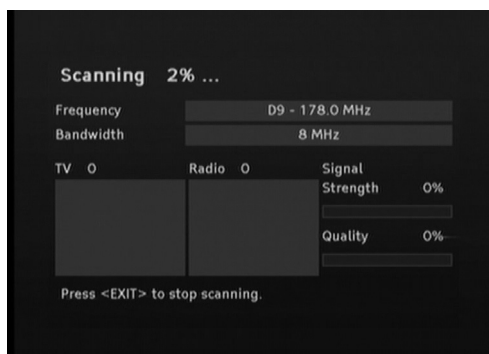

*Note: By pressing the **EXIT** button, you can stop the scan mode at any time.*

As soon as the search is completed, an according message is displayed. Acknowledge this and the following message by **OK**, in order to proceed to the TV replay.

Change of channel

You can change the channel in different ways:

- By pressing the **channel button** **+** or **-**.
- By pressing the **arrow button** **▲** or **▼**.
- By pressing the **Back / P<P button**, you switch between the two last selected channels.
- By selecting the channel directly via the channel list, see page 12.
- By entering the memory number in the channel list. For this purpose, enter the number via the **numerical buttons**. If, for instance, the memory number is 0014, quickly press the numerical buttons 1 and 4 successively. The zeros do not have to be entered.

Volume control



- Use the **volume buttons** **+** and **-** for increasing or decreasing the volume, or
- use the **arrow buttons** **◀** or **▶** for this purpose.

Mute function

By pressing the **mute button**, the sound reproduction is stopped. The sound is audible again if you ...

- ... press the **mute button** again, or
- ... press one of the volume control buttons.

Calling up information banner

Every time you change the channel, the information banner is displayed.

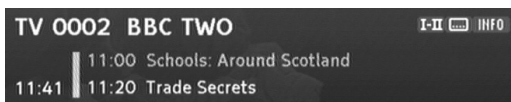

- 1 Press the **INFO button** to call up the information banner without changing the channel.

The information banner displays the selected channel memory number and the channel name. In addition, the time is displayed on the left edge of the information banner.

The display bar on the right next to the time graphically indicates the programme time that has already elapsed. The lower menu line displays the current and the next programme including its broadcasting time. After several seconds, the information banner is automatically hidden again.

Note: You can define the display time of the information banner for yourself, or completely prevent the automatic display, see "Menu settings" on page 17.

While the information banner is displayed on the lower screen edge, you can call up the extended information

banner by pressing the **INFO button** again. The extended information banner supplies further details with regard to the current programme.



Observe:

- If the text is more extensive, it is distributed to several pages. In the previous example illustration, for instance, page 1 of 3 (1/3) is displayed. By repeatedly pressing the **OK button**, you browse the pages (**arrow buttons** **▲** and **▼** are also possible).
- If you press the **INFO** or **arrow button** **▶**, information on the next programme is displayed. By pressing the **arrow button** **◀**, you return to the information on the current programme.

Note: The extended information banner is not automatically closed.

- 2 Press the **EXIT button** in order to close the information banner.

Using options

Some channels occasionally provide several camera perspectives, sound tracks and/or teletexts.

If a channel provides one or more of these options, the respective button name is displayed in the right corner when calling up the channel, whereby also several names can be displayed, e. g. **TEXT** and **I-II**.



This means that, for instance, a sound, caption, or text selection is provided.



How to use the options:

- 1 Call up the desired channel.
- 2 Press the **I-II button** for sound selection or the **APP button** for caption selection.
 - If a teletext is offered, you can call it up by using the **TEXT button**.
 - Via the **OPT button** you can also call up the options.
 - In case of several options, repeatedly press the **OPT button**, in order to select the desired option.
- 3 By using the **arrow buttons** ◀ / ▶ / ▲ / ▼ , select the desired option and press the **OK button**. The selected option is called up, and the option window is closed.

Using teletext

- 1 Press the **TEXT button** ▼ to call up the teletext.

*Note: You possibly also have to press the **OK button** in order to display the teletext and to specify whether you want to use the teletext of your TV, or that of the receiver.*

Operation in detail:

- Via the **numerical buttons**, you can skip to a specific page.
 - Via the **MENU button**, you directly skip to page 100, via the **EPG** or **LIST/FAV** button to page 300.
 - Via the **arrow buttons** ▲ and ▼ , you respectively skip to the next or previous page. For this purpose, you can also press the red or the green colour button.
 - By pressing the yellow or the blue **colour button**, you respectively skip 10 pages forwards or 10 pages backwards, relating to the next full unit of ten, e. g. 133 > 140 > 150, etc.
 - By means of the **channel buttons** + and -, you respectively skip 100 pages forwards or 100 pages backwards, relating to the next full unit of hundreds, e. g. 462 > 400 > 300, etc.
 - Via the **arrow buttons** ◀ and ▶ , you can highlight a page number on context pages and directly skip to the selected page by pressing the **OK button**.
 - The teletext display is enlarged if you press the **I-II button**. By pressing this button again, the teletext is displayed in its normal size again.
 - The automatic turning of a subpage (e. g. page 3/6) is interrupted if you press the **TIMER/REC button**.
 - By pressing the **TEXT button** ▼ again, the teletext is transparently applied over the TV picture; pressing the button again, completely hides the teletext.
 - By using the **Back / P<P button**, you switch between the teletext and transparent text.
- 2 Completely hide the teletext by pressing the **EXIT** or **TEXT button** ▼ .

Using channel list

- 1 Press the **LIST/FAV button** to call up the channel list.

*Note: If no other window on the screen is opened, you can also call up the channel list by pressing the **OK button**.*

This list contains all TV channels the device has found and stored during automatic channel scan.



*Note: If you again press the **LIST/FAV button**, the favourites list is displayed. This individual channel list only contains the channels you have "favoured". For further information on this, see page 13. Favourites are indicated by an asterisk in the channel list.*

- 2 Use the **arrow buttons** ◀ / ▶ / ▲ / ▼ to select the desired channel from the list.
 - By using the **arrow buttons** ▲ or ▼ , you highlight the next or the previous channel in the list.
 - By using the **arrow buttons** ◀ or ▶ , you skip eight positions in the channel list forwards or backwards.
- 3 Press the **OK button** after you have selected the desired channel.

The programme of the selected channel is displayed in the background; the channel list remains open for another several seconds.

During this time, you can select another channel by using the **arrow buttons**, or press the **OK button** in order to close the channel list immediately.

Note: If the device is switched to radio mode, you can also carry out the previously described actions in the same manner for the stored radio channels.

Creating and Editing channel list

Possibly the channel list may appear too complex to you or contain channels that you are not interested in watching.

Via the main menu, you can edit and create your own favourite list.

- 1 Press the **MENU** button.
- 2 Select the menu item **Sort Channels** by the **arrow buttons** ▲ or ▼ and press the **OK** button.



- 3 After you have carried out the desired settings, press the **EXIT** button in order to close the window.

Defining channels as your favourites

The favourites list contains all channels you have defined as favourites. By means of this list, you can create a personalised channel list.

- 1 Select the channel you want to indicate as a favourite by using the **arrow buttons** ▲ or ▼.
- 2 Press the **OK** button to add the channel to the favourite list.
- 3 Repeat this process with all channels that you want to indicate as favourites.

Note: The previously described functions are also provided to you with regard to the radio channel list.

*Press the **RADIO** button to call up the overview for the radio channels. You can return to the TV channel list by pressing the **RADIO** button again.*

Shifting channels in the favourite list

You can individually set the sequence of the channels within the channel list.

- 1 Press the **arrow button** ▶ to highlight and edit the favourite list.
- 2 Highlight the channel you want to shift by using the **arrow buttons** ▲ or ▼.
- 3 Press the **OK** button to confirm the channel to be shifted.
- 4 Shift the highlighted channel to the desired position by using the **arrow buttons** ▲ or ▼.

- 5 Press the **OK** button to store the channel at the desired position.

Deleting channels in the favourite list

- 1 Highlight the channel you want to delete by using the **arrow buttons** ▲ or ▼.
- 2 Press the **red colour button**.
- 3 To delete all the channels in the favourite list, press the **yellow colour button**

Extended installation

In the main menu you can choose between **automatic scan mode** and **expert scan mode** via **automatic channel scan**.

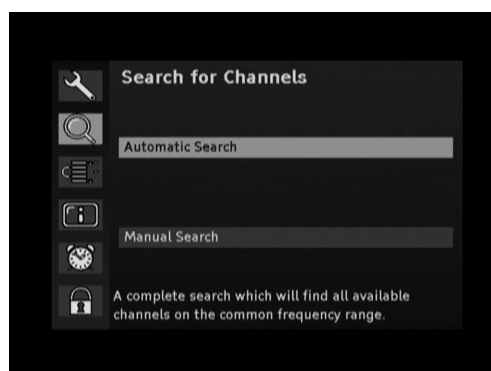

After the initial installation, see page 10, it may be required to search for channels again, or to add specific channels that are additionally broadcasted.

Note: In order to carry out a new initial installation, you have to reset the device to its default settings, see page 16.

Automatic scan mode

This scan mode usually is the right one, because during this scan mode normally all channels are found automatically.

- 1 Only if you use an active antenna (otherwise continue from point 4.): Highlight the **antenna setting** and press the **OK** button.
- 2 Switch the active antenna **On** by using the **arrow button** ◀ or ▶.
- 3 Press the **EXIT** button.
- 4 Highlight the **automatic scan mode** and press the **OK** button.
- 5 Set the start or stop frequency via the **arrow button** ◀ or ▶.
- 6 Specify by the **arrow buttons** whether **all channels** or channels that are **free-to-air only** are to be searched.
- 7 Then highlight **OK** and press the **OK** button to start the automatic scan mode

Following, the scan mode is started. After the search is completed, the following is displayed:



- 8 By using the **arrow button** ◀ or ▶, choose whether
 - the channels found are to be added to the old list (standard setting),
 - the old channel list is to be overwritten,
 - the new found channels are to be discarded.
- 9 Then press the **OK button**.

Expert scan mode

This type of scan mode enables the specific search for an individual channel. This in particular makes sense if you only want to include one individual channel into your channel list and you know the information on the channel and frequency.

- 1 Highlight the **expert scan mode** and press the **OK button**.

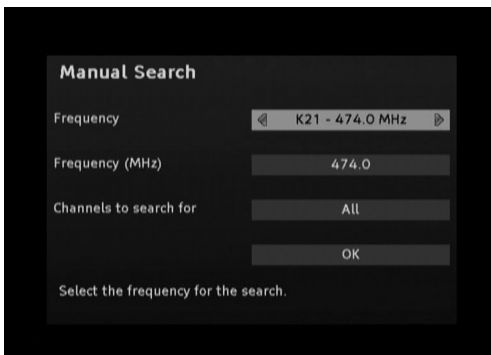

- 2 Successively select the adjustable values by using the **arrow button** ▲ or ▼.
 - The desired **frequency** is set by the **arrow button** ◀ or ▶.
 - The **frequency in MHz** is entered via the **numerical buttons** of the remote control.
 - The desired **band width** is set via the **arrow buttons**.
- 3 Choose whether **all channels** or channels that are **free-to-air only** are to be searched for.
- 4 Then highlight **OK** and press the **OK button** to start the expert scan mode.

Following, the scan mode is started.

- If some channels were found, you receive the same request as with regard to the automatic scan mode, see previous paragraph.
- If no channels were found, a message is displayed. Press the **OK button**.

EPG

The electronic programme guide (EPG) offers you an overview of all programmes to be broadcasted in the next week on the current channel.

Observe:

- Not all channels offer an extensive EPG.
- Many broadcasting services broadcast the current day programme but do not offer detailed descriptions.
- There are broadcasting services that do not offer any EPG information.
- Due to the progressive technical development, more and more broadcasting services will extend this offer in the future.

- 1 Select the desired channel.
- 2 Press the **EPG button** to call up the electronic programme guide.



The following functions are offered to you by the EPG:

- If you require more information on a programme, highlight it by using the **arrow button** ▲ or ▼, and press the **INFO button**.
- Change to the programme of another day by using the **arrow button** ▶. By means of the **arrow button** ◀ you can return.
- In order to switch between the programmes of the afternoon and evening, press the **colour buttons** displayed in the EPG.

Note: Depending on the time of day, also "tomorrow" may be displayed.

- By pressing the **channel +** or - button, you can view the EPG of another channel.
- If you want to adopt a programme into the timer list, highlight it and press the **TIMER/REC button**. Acknowledge the following request by pressing the **OK button**.

Note: Detailed information on the subject "timer" can be found in the next paragraph.

- 3 Close the EPG by pressing the **EXIT button**.

Timer

By means of the timer setting, you can switch your receiver on and off at a specific time, for instance, in order to allow for the recording with a video-tape recorder. The device then automatically switches on in the standby mode. If the device is already switched on, the device automatically switches to the selected programme.

Note: Remember to program your video-tape recorder to the respective time.

Adding programme to timer list

The timer function is included into the timer list via the EPG, see previous paragraph.

- 1 Open the EPG and highlight the desired programme.
- 2 Press the **TIMER/REC** button.



- 3 Press the **OK** button.

The window is closed and the selected programme is stored in the timer list.

Editing timer list

During the normal programme replay, press the **TIMER/REC** button to open the timer list.



Deleting (a) programme(s)

- 1 Select the desired programme.
- 2 Press the respective **colour button**:
red: the selected programme is deleted
yellow: all programmes are deleted.
- 3 Press the **OK** button to acknowledge the following request.

Timer editing

- 1 Select the desired programme and press the **OK** button.

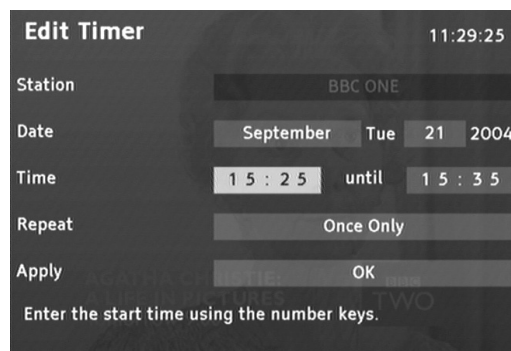

- 2 Alter the displayed settings by using the **arrow** and **numerical buttons**. In doing so, you can:
 - change the date (month and day)
 - the time (starting time and duration)
 - the cycle (interesting for series and regularly recurring programmes)
- 3 Then highlight **OK** behind **adopt**, and press the **OK** button.

Switching off current timer functions

Note: During a timer programme, only few buttons can be activated: I-II, APP, OPT, as well as the volume buttons + and -, as well as the mute button.

To switch off the timer function:

- 1 Press **on / off**.
A programme message is displayed.
- 2 Press the **OK** button.

Miscellaneous functions

Restoring default settings

You can reset the device to default settings. In doing so, the individually composed favourites list is deleted.

- 1 Press the **MENU button** to open the main menu.
- 2 Highlight the item **settings** by using the **arrow buttons** ▲ or ▼ and press the **OK button**.
- 3 Highlight the item **calling up default settings** and press the **OK button**.



- 4 Set **yes** by using the **arrow button** ►, and press the **OK button**.

The device carries out a reboot. It switches off, and shortly afterwards switches on again.

- 5 Carry out an initial installation, see page 10.

Displaying channel and system information / adjusting the antenna

This function (nearly) solely serves to supply information on one channel. However, you can use it for adjusting your antenna and for improving the television reception.

- 1 Press the **MENU button** to open the main menu.
- 2 Highlight the item **channel and system information** by using the **arrow buttons** ▲ or ▼, and press the **OK button**.
- 3 Select the item **channel information** and press the **OK button**.

BBC ONE - Channel Information	
Frequency	K44 - 658.0 MHz
Parameters	BK G-1/32 QAM-64 CR-3/4
Network	300F Rowridge
Provider	BBC
Service ID	4163 Audio PID 601
Teletext PID	0 Video PID 600
Signal Strength	95%
Signal Quality	100%

- 4 Adjust your antenna so that the two specifications **signal strength** and **signal quality** display a preferably high value.

Note: Depending on your antenna, you can possibly also carry out settings on your antenna.

- 5 Press the **EXIT button** 1x and acknowledge the selection **system information** by using the **OK button**. Here you find technical information on your device. This information normally is only relevant with regard to support.
- 6 Press the **EXIT button** twice to return to the normal TV programme.

Displaying the time

- 1 Press the **TEXT button** ▲ to receive a time display on the screen during programme replay.
- 2 Press any **TEXT button** to hide the time again.

Switching between set top box and TV

- 1 Press the **TV/STB** key to switch between the set top box and the TV signal.

Carrying out software update

Note: For this purpose, the device has to be set to standby operation.

Every night between 1 am and 5 am, the device checks whether a software update is available. If this is the case, you'll receive an according message when switching the receiver on the next time, and you can start the software update.

You can also start the search process manually.

- 1 Open the main menu and select the option **system information** from the field **channel and system information**.
- 2 Highlight the item **software update** by using the **arrow buttons**.
- 3 Press the **OK button** to start the software update.

Radio

Note: A digital radio programme currently is not broadcasted in all countries via antenna.

- 1 If a digital radio programme is broadcasted in your country, press the **RADIO button** to receive it.
- 2 In order to view the TV programme again, press the **RADIO button** again.

Settings

- 1 Press the **MENU** button to open the main menu. The menu item **settings** is highlighted by default.
- 2 Press **OK**.

You'll receive the following screen:

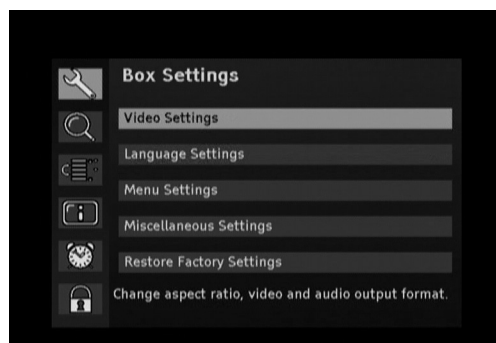

- 3 By using the **arrow button** \blacktriangle or \blacktriangledown , highlight the desired option and press the **OK** button in order to call it up.

Note: In either case, observe the information texts displayed on the screen. They will help you to select the correct settings.

Selecting and altering the settings is effected as usual by means of the **arrow buttons** \blacktriangleleft / \blacktriangleright / \blacktriangle / \blacktriangledown ; a window that is inserted can be closed by pressing the **EXIT** button.

Picture settings

Screen format

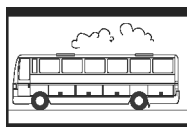

4:3 (Letterbox 16:9)

Reduces films in 16:9 mode for 4:3 format TVs to scale, and for this purpose inserts a black bar above and below on the screen.



4:3 (Pan Scan / CCO)

Presents films in the 16:9 format in a screen-filling manner. With regard to 4:3 TVs, the left and right picture border is cut off.

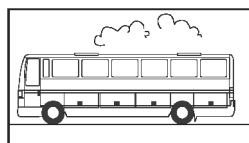

16:9 format

Presents films on a 16:9 TV in full size.

Video output TV

For the "video output TV", the formats **RGB**, **video (FBAS)** and **S-Video (Y/C)** are provided. Here **RGB** presents the correct selection in most cases.

Video output VCR

*Note: This item can only be selected, if you have **not** selected RGB with regard to "video output TV".*

Here you can choose between **video (FBAS)** and **S-Video (Y/C)**.

Automatic AFD

The broadcasted picture format may deviate from the picture format to be displayed. AFD recognizes and corrects the presentation if you select the option **ON**.

Teletext

By means of this function you can choose whether your receiver or your TV set is to display the teletext.

Default settings

By means of this function you reset the configuration for the picture settings to previous set default values. These settings in most cases allow for an acceptable image & language reproduction.

Language

Menu language

Here you set the language of the OSD (on-screen display).

Audio language

Select a reproduction language for the programmes.

Second audio language

Select an optional reproduction language for the programmes.

Note: If the desired programme is not broadcasted in the language set under "audio language", the "second audio language" is used.

Caption language

Select a language for the captions.

Second caption language

Select an optional caption language for the captions, see also "second audio language".

Automatic captions

Set this option to **on** if you want to automatically show broadcasted captions in the selected caption language (default: **off**).

Menu settings

Display duration of information banner

Here you define for how long the information banner, see page 11, is to be shown with regard to a change of channel. If you want to completely eliminate the information banner in case of a change of channel, select **not any**.

Automatic information banner

At the start of a new programme, the information banner is automatically shown as a default. If you do not want this, select **off**.

Note: This option is only available if the value set under "display duration information banner" is at least 4 seconds.

Menu language

Set the language of the OSD.

Note: This function is also available via "language"; see page 17.

Transparency

Here you set the transparency of the OSD. If you have difficulties to read the OSD with transparent setting, select **not any**.

General

Setting a time zone

Select whether the local time offset with regard to Greenwich mean time is to be set automatically, or if you want to specify it yourself.

Time zone

Select the entry **GMT +01:00** for Germany and Central Europe (time difference with regard to the Greenwich mean time).

Summer time

Set the menu item **summer time** to **off** if it is not summer time at the moment. You can also select the setting **automatic**. In case of this setting, the receiver obtains the information regarding summer time from the currently selected channel.

Audio output format

For the audio output, the formats **mono** and **stereo** are provided to you.

Calling up default settings

This function has already been described elsewhere, see page 16.

Security

- 1 Press the **MENU** button.
- 2 Highlight the item **safety** by using the **arrow button** ▲ or ▼, and press the **OK** button.
- 3 Enter the PIN code and acknowledge by **OK**.

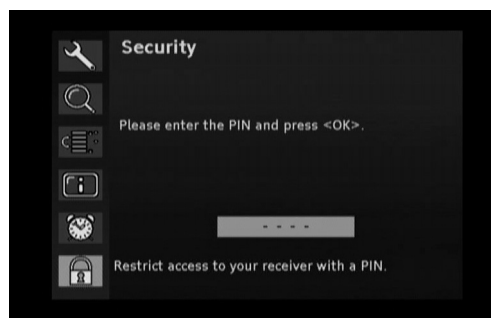

Note: The PIN code is set to 0000 by the factory. Also observe the displayed information. It will help you to select the correct settings.

Observe:

- Selecting and altering the settings is carried out as usual by means of the **arrow buttons**.
- A displayed window can be closed by pressing the **EXIT** button.

PIN lock

Set this option to **on** if you want to protect your complete device against unauthorized access.

When the receiver is switched on the next time, the PIN request is effected (the PIN code is set to 0000 by the factory).

Menu lock

Set this option to **on** if you want to protect your menu against unauthorized access.

When the menu is called up the next time, the PIN request is effected (the PIN code is set to 0000 by the factory).

Protection of minors

Here you can define a minimum age for specific programmes. These programmes are PIN protected and are only unlocked by a PIN request.

Changing device PIN

Here you can specify your personal PIN code.

- 1 Press the **OK** button.
- 2 For this purpose, enter the current PIN code and acknowledge by pressing the **OK** button.
- 3 Following, enter your new PIN code and press the **OK** button.
- 4 For acknowledging your new PIN code, enter it again and press the **OK** button.

Troubleshooting

If you experience an operating problem with your Digital Set Top Box, please refer to the trouble-shooting table below and then the notes that follow.

Symptom	Possible cause	Remedy
No picture and no sound	No channel list or wrong channel list	Do an automatic station scan
	Short circuit in aerial lead	Turn off receiver, remove short circuit and then turn on again
	Defective or missing cable connection	Check all cables
	Poorly adjusted aerial	Adjust aerial
	Loose connectors or cable too long	Check connectors and shorten cable
No picture or picture is blocky in appearance	Aerial too small	Use a bigger aerial
	SCART connector not fully plugged in	Check SCART connector
Sound but no picture	Aerial poorly adjusted or defective	Check aerial
	Program is being broadcast with altered parameters	Do an automatic search (see Advanced Installation)
	SCART connector not fully plugged in	Check SCART connector
Cannot receive station that you could receive before	Program is no longer broadcast	None
	Interference with „DECT“ phones or wireless equipment	Move phone/wireless equipment away from the receiver to a location where interference ceases
	Program is being broadcast with altered parameters	Do an automatic search (see Advanced Installation)
Remote control is not working	Obstacle in between remote control and receiver	Remove obstacle
	Transport stream defect	Unplug receiver and then plug in again
	Flat battery	Replace battery
Certain stations cannot be received from time to time	These services are not transmitted 24 hours a day and can sometimes be unavailable. This is not a fault.	
STB cannot be controlled	Obstacle in between remote control and receiver	Remove obstacle
Poor image quality or no colours	Wrong TV SCART out signal	Try changing from RGB to CVBS or vice versa (see Configuration)
	Inappropriate video type selected	Set video output according to TV set video requirements (see Configuration)
You have forgotten or lost your PIN code	Reset from the Parental Control Screen. To access the Parental Control Screen, use the following 4-digit code: 8111. Keep this code secret to prevent others from using it. Refer to section “Protection of minors” on page 18 for more detailed information.	

If none of the above suggestions seem to work, try switching your Set Top Box off and then on again. If this does not work, contact either your supplier or a qualified repair technician. Never attempt to repair your set top box yourself.

General

- DVB terrestrial Free-To-Air receiver compliant to EN 300 744
- VHF and UHF frequency range support
- Video and Audio out via 2x SCART
- Digital audio out
- Fast channel search
- Reed-Solomon decoding support (EN 300 744)
- Automatic FEC selection (1/2, 2/3, 3/4, 5/6, 7/8)
- MPEG2 Transport Stream support: ISO/IEC 13818-1
- DVB-Video/-Audio support: ISO/IEC 13818-2, -3
- Software update via antenna (update over air)

Base specification

- QPSK / QAM16/64 demodulation compliant to DVB terrestrial standard EN 300 744
- COFDM 2k and 8k
- VHF and UHF support (174 ... 862 MHz)
- 7/8 MHz channel bandwidth
- Guard Interval Modes: 1/32, 1/16, 1/8, 1/4 active symbol duration
- Fast PLL tuning speed:
step size 62,5 kHz / 166,67 kHz

Input /Output

2x SCART (VCR & TV) out

- TV SCART video out: RGB, CVBS, Y/C
- VCR SCART video out: CVBS, Y/C
- switching signal: 0 / 6 / 12V
- Audio out (left/right)

Digital audio out (S/PDIF)

RF input

connector IEC60169-2 female

- termination 75 Ohm
- Return Loss: min. 6 dB (75 Ohm)

Loop-Through of RF signals

- output termination 75 Ohm

Power Supply

- Power supply 230VAC/50Hz to 12VDC
- Operation power consumption less 7 W
- Maximum stand-by mode consumption: 5 W

Dimensions of the device: approx. 250 x 140 x 32 mm

Accessories

- Power Supply
- SCART/SCART cable
- Remote Control
- 2 Batteries (for remote control)
- User manual

Temperature

- Temperature-Range +5 °C...+40°C

This product complies with the requirements of the 95/47/EC and 2002/21/EC directives.

The product complies with the following European council Directives: 73/23/EEC, 93/68/EEC and 89/336/EEC.

