

SOUNDSTREAM[®]
T E C H N O L O G I E S



RUBICON

502

702

1002

Power Amplifiers

Owner's Manual
and
Installation Guide

SOUNDSTREAM[®]
T E C H N O L O G I E S

SOUNDSTREAM TECHNOLOGIES

120 Blue Ravine Road • Folsom • California 95630 USA
ph 916.351.1288 • fax 916.351.0414

rev B-3/10/98

Congratulations!

You now own the Soundstream RUBICON amplifier, the product of an uncompromising design and engineering philosophy. Your Soundstream RUBICON amplifier will outperform any other amplifier in the world.

To Maximize the performance of your system, we recommend that you thoroughly acquaint yourself with its capabilities and features. Please retain this manual and your sales receipt for future reference.

Soundstream amplifiers are the result of American innovation and the highest quality control standards. When properly installed, they will provide you with many years of listening pleasure. Should your amplifier ever need service or replacement due to theft, please record the following information which will help protect your investment.

Model and Serial # _____

Dealer's Name _____

Date of Purchase _____

Installation Shop _____

Installation Date _____

CAUTION!

Prolonged listening at high levels may result in hearing loss. Even though your new Soundstream Rubicon amplifier sounds better than anything you've ever heard, exercise caution to prevent hearing damage.

Table of Contents

Design Features	p 4 - 5
Rubicon Amplifier Diagram	p 6 - 7
Crossover Adjustments	p 8 - 9
Hawkins Bass Control™ Theory and Use	p 10 - 11
Installation: Speaker Output Modes	p 12
Installation: Balanced / Unbalanced Inputs	p 13
Installation: Wiring and Diagram	p 14 - 15
Installation: Mounting	p 16
Installation: Level Setting and Front Spoiler.	p 17
Protection Circuitry and Troubleshooting	p 18
Service	p 19
Specifications	p 19

DESIGN FEATURES

- ◆ **RUBI™** (Rapid-Use Branching Impulse) This new proprietary power supply topology eliminates “power sags” during low frequency reproduction by rapidly increasing the duty cycle, stabilizing the power supply and allowing it to deliver the power required when reproducing low frequencies. Also, greater reserve gate power is stored for low voltage conditions that occur during extreme conditions.
- ◆ **STACT™** (Stabilized Apex Current Topology) Reduces power supply stress by 50%. Typical designs degrade the stereo image due to phase reversal of even-order harmonic distortion that occurs between the inverted channels. In the STACT design, inversion is done at the power amplifier drive stage. Since the fully symmetrical power amplifier produces no even-harmonic distortion itself and all preamplifier circuitry is run completely in-phase, no even harmonic distortion phase reversal occurs.
- ◆ **Trident™ Protection Topology** provides three types of protection:
 1. Output protection against short circuits or improper loads.
 2. Ground fault detection: Shuts down the amplifier when a significant voltage (>5Volts) fluctuation occurs between electrical (turn-on lead) and battery ground.
 3. Thermal Protection: Puts the amplifier into thermal rollback or shuts the amplifier down in extreme thermal conditions.
- ◆ **Hawkins Bass Control** - Fully adjustable subwoofer equalization circuit providing frequency and boost (“Q”) adjustment for optimum subwoofer performance. A frequency tracking subsonic filter protects woofers from potentially harmful low frequency information and maximizes output in a usable range.
- ◆ **Harmonic Bass Alignment™** The 2nd and 3rd order harmonic peaks are critically aligned to fundamental peaks at low frequencies. This produces tighter, more accurate bass reproduction.
- ◆ **Drive Delay II™** Amplifier section powers up 2 to 3 seconds after the power supply eliminating turn-on and off pops. The turn off process is reversed: Amplifier section turns off first, followed by the power supply.

- ◆ **Output Clipping Indicators** indicate clipping on the output stage of the amplifier. Monitoring the clipping indicators allows the user to achieve maximum Sound Pressure Level without clipping the amplifier.
- ◆ Dynamically Optimized **Power Grid™**. Power grid is evenly distributed between primary and secondary power supplies, providing greater dynamics and improved RF filtering.
- ◆ **Auto High Current™** automatically matches the amplifier to the load being driven allowing greater system flexibility, greater output, higher reliability, and high efficiency 1 ohm (stereo) operation.
- ◆ **Chassisink™** All transistors are ideally located and sandwiched between the circuit board and the heatsink to provide cool efficient amplification operation.
- ◆ **Differentially Balanced RCA Input** eliminates ground loop related noise in the audio.
- ◆ **Fully Balanced 6-pin DIN Input** for professional-quality performance and noise cancellation. The 6-pin DIN plug carries (±) signal information for Left and Right channels, audio ground, and ± 15 Vdc to operate the Soundstream **BLT / BLT4** Balanced Line Transmitters.
- ◆ **Continuously Variable Crossover Networks:** 12 dB/Octave highpass variable from 70 to 160 Hz, and 24 dB/Octave lowpass crossovers variable from 55 to 220 Hz.
- ◆ **Flexible Dual Input Level Control** allows 300 mV to 5 V input sensitivity Separate Left and Right level controls allow user to optimize system level control.
- ◆ **Symmetrical Discrete Balanced Class A Drive Boards** Auto-adjust for linear performance while driving low impedance loads.
- ◆ **Removable Front Spoiler** allows for stealth installation of RCA, Balanced Line, Speaker and Power wiring.

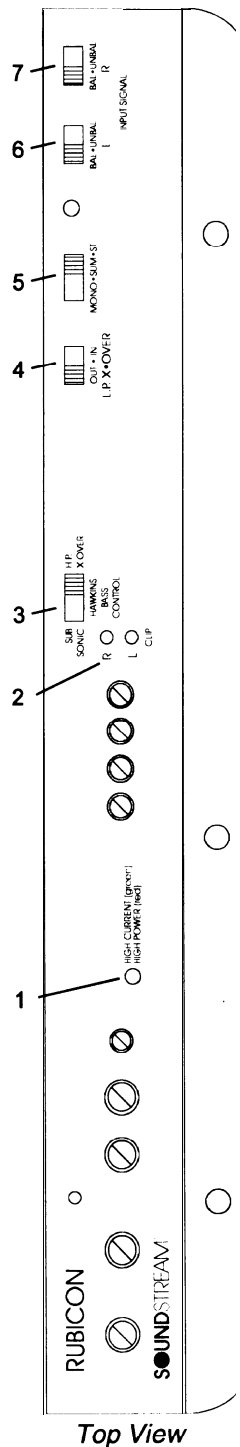

Top View

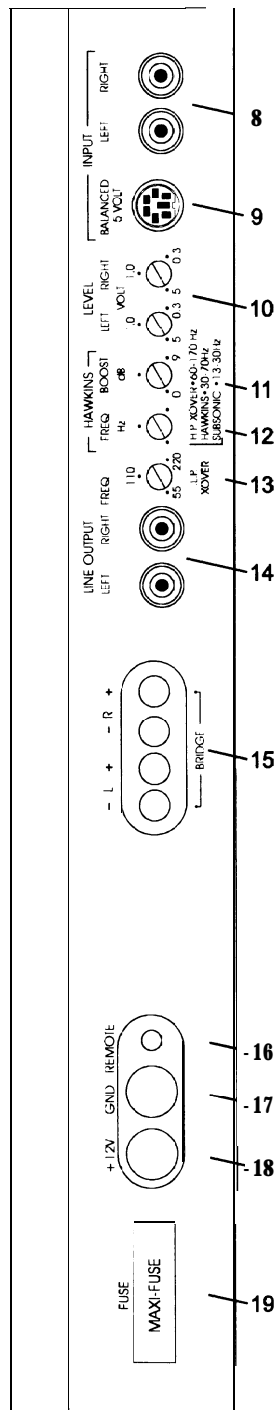

Front View

KEY TO CALLOUTS

1. **Power LED** - Indicates amplifier power, either in High Power or *Auto High Current*.
2. **Clip Indicators** - Indicates the signal output level is too high and the output stage of the amplifier is clipping.
3. **Subsonic, Hawkins Bass Control, H.P. Xover Switch** - Selectable high pass filter frequency range. Select "SUB SONIC" to engage the Sub Sonic filter with no boost. Use the knob indicated by callout #12 to set the frequency: 13-30Hz). Select "Hawkins Bass Control" to engage the Sub Sonic filter with available boost. Use the knob indicated by callout #12 to set the frequency: 30 Hz to 70 Hz. Select "H.P. XOVER" to engage the amplifier's high pass filter for running satellite speakers. Use the knob indicated by callout #12 to set the frequency: 70-160 Hz.)
4. **Low Pass XOVER Switch** - Selectable low pass filter for driving subwoofers. Use the knob indicated by callout #13 to set the low pass frequency. *Note: Do not have the "L.P. XOVER" and the "H.P. XOVER" engaged at the same time.*
5. **MONO/SUM/ST Switch** - "MONO" for bridged mono operation with a single input signal (right channel only). "SUM" for bridged mono operation summing two input signal (left and right). "ST" for normal stereo operation,
6. **Left Channel Balanced/Unbalanced Input Selector** - Select "BALANCED" to use the 6 pin Balanced signal input. Select "UNBALANCED" to use the RCA signal inputs.
7. **Right Channel Balanced/Unbalanced Input Selector** - Select "BALANCED" to use the 6 pin Balanced signal input. Select "UNBALANCED" to use the RCA signal inputs.
8. **RCA Inputs** - Right and Left channel RCA (Unbalanced) inputs.
9. **Balanced Signal Input Connector** - 6-Pin Balanced input connector for use with the Soundstream **BLT/BLT4** Balanced Line Transmitter.
10. **Input Levels** - Independent Left and Right input level controls.
11. **Hawkins Bass Control "Boost" Adjustment** - Varies from 0 to +9 dB of boost when the Hawkins Bass Control circuit is engaged.
12. **High Pass Filter Control Adjustment** - Frequency adjustment control for the High Pass filter, the Hawkins Bass Control filter, or the Sub Sonic filter.
13. **Low Pass Filter Control Adjustment** - Frequency adjustment control for the Low Pass filter.
14. **Line Outputs** - Line level RCA outputs to drive an external amplifier (Note: The outputs are full-range.)
15. **Speaker Connection Terminal** - Speaker connections for Ch's 1 & 2.
16. **REMOTE** - Remote turn-on input from the head unit. Accepts +12V.
17. **GND** - Main ground connection. Bolt to a clean chassis point in the vehicle.
18. **+12V** - Connected to a fuse or circuit breaker, then to the battery's positive terminal
19. **FUSE** - Main power supply fuse. Warning: Replace only with the same value fuse!

CROSSOVER ADJUSTMENTS

The RUBICON amplifiers incorporate an on-board staggered electronic crossover, with RCA outputs to drive an external amplifier. No external electronic crossover is necessary. The high and low pass portions of the crossover can be set independently of one another.

To engage the High Pass filter, set the left crossover switch on the top of the amplifier to "H.P. X-OVER", and use the frequency adjustment knob marked "H.P. X-OVER". To engage the Low Pass filter, set the left crossover switch to either "SUB SONIC" or "HAWKINS BASS CONTROL" (see pages 1 O-1 1 for more details), and set the right crossover switch "L.P. X-OVER" to the "IN" position.

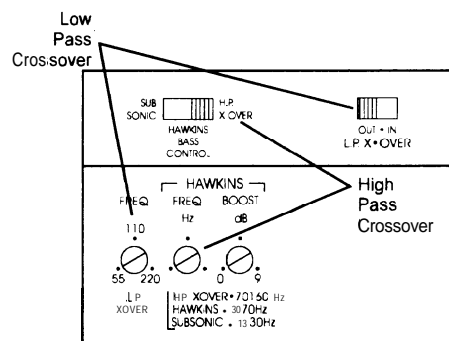

IMPORTANT: Do not have the Low Pass filter and the High Pass filter both engaged at the same time. While this won't damage the amplifier, the frequency range of the amplified signal will be severely limited.

In many car audio installations, there is a tendency for a "midbass boom." Because of their interior dimensions, most cars will resonate or ring at these midbass frequencies. If we design the system so there is reduced output in this region, the final response is very smooth and natural sounding. The high pass crossover is independently variable from 70 to 160 Hz at 12 dB/Octave, and the low pass crossover is independently variable from 55 to 220 Hz at 24 dB/Octave.

For initial crossover setup, try setting the low pass filter to approximately 60 Hz, and the high pass filter to approximately 100 Hz. Change the crossover points to accommodate a good mixture of frequency response, power handling, and personal preference.

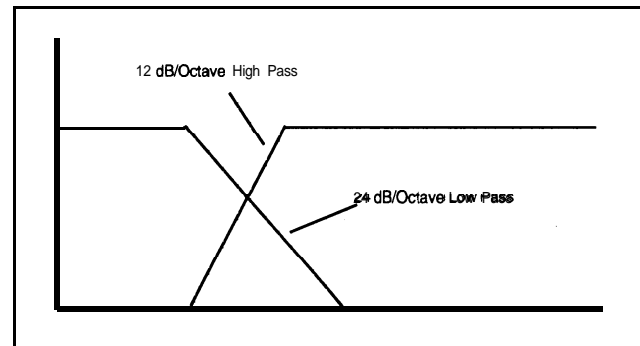

Hawkins Bass Control - Theory and Use

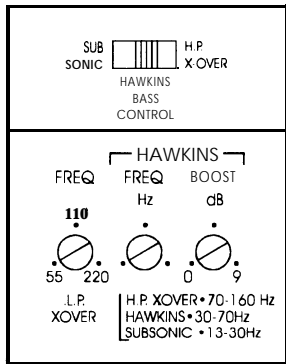

FIG. 1 BASS CONTROL

The frequency control (Hz) adjusts the starting point of the subsonic filter. On the RUBICON502, 702 and 1002, the high pass filter has two frequency ranges. When the bass control switch is set to "SUB SONIC", the high pass filter frequency can be adjusted from 13 Hz up to a maximum of 30 Hz. In this setting, no boost "Q" control is available. This control is useful for setting the lowest frequency that your subwoofer will see (see figure 1). When the bass control switch is set to "HAWKINS BASS CONTROL", the high pass filter frequency can be adjusted from 30 Hz to a maximum of 70 Hz. In this setting, there is an available boost control of 0 to +9 dB.

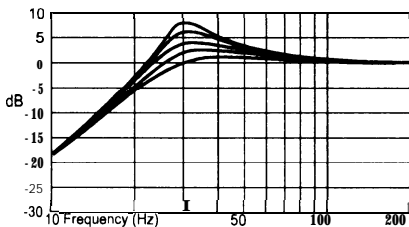

FIG. 4 VARIABLE BOOST

Hawkins Bass Control (*parametric*) is a unique subwoofer control circuit included with the Soundstream RUBICON502, 702 and 1002 amplifiers. It is capable of removing subsonic energy in program material while boosting subwoofer frequencies. The circuit consists of two controls. One adjusts the frequency of operation and the other adjusts the range of boost. With both controls adjusted fully counter-clockwise, no boost is applied and the amplifier is flat in response down to 20 Hz.

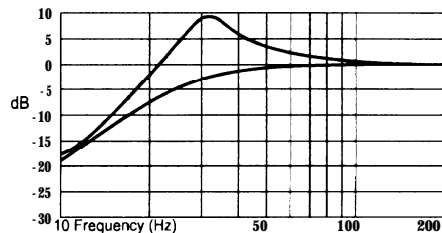

FIG. 2 VARIABLE "Q"

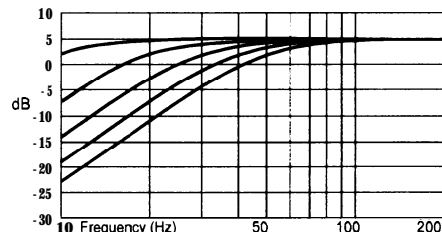

FIG. 3 VARIABLE HIGH PASS

The Boost control adjusts the amount of level applied at the set frequency. This is adjustable from flat (0dB) to +9 dB. (See figure 2)

When the Boost is set to 0, Hawkins acts as a sub-sonic filter only. (See figure 3) The simple act of removing potentially harmful low frequencies can improve system output by as much as 3 dB. (see figure 4)

Application

Subwoofer drivers in general have excellent power handling characteristics over their operational bandwidth. This bandwidth is determined by many factors, including driver design, and enclosure type. It is possible to overdrive any subwoofer driver by sending powerful signals outside of its operational bandwidth.

These potentially damaging signals can be removed by adding a subsonic filter. Figure 5 shows the effectiveness of the Hawkins Bass Control on woofer excursion in a vented enclosure. The woofer travels 7.5 mm at 10 Hz. With Hawkins Bass Control properly adjusted, this excursion can be reduced to less than 1 mm. This is of great benefit to lowering woofer distortion and increasing output.

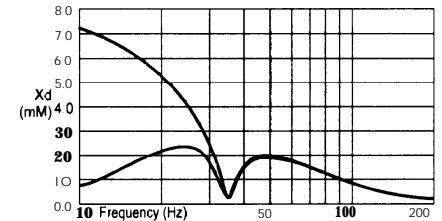

FIG. 5 LIMITED EXCURSION

Adjustment

An easy method of optimizing your existing subwoofer enclosure with Hawkins's "Hz" control is as follows.

1. Adjust frequency and boost control to full CCW position.
2. Set the bass control switch to "HAWKINS BASS CONTROL".
3. While listening to music with strong bass content at a moderate level, slowly adjust frequency control clockwise. Listen for a reduction of bass response. Now, rotate frequency control slightly backwards. This serves the purpose of removing the "subsonic" bass energy.

With Soundstream's Hawkins Bass Control, the boost and frequency control can provide virtually any combination of boost and cut to suit your designs. So, Hawkins Bass Control can provide the "tailoring" needed for any type of "assisted" design and any woofer in any type of installation.

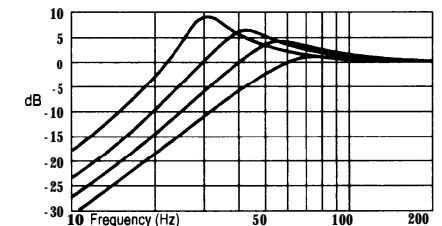

FIG. 6 VARIOUS SETTINGS

INSTALLATION STEP 1

SELECTING THE SPEAKER OUTPUT MODE

The RUBICON502, 702 and 1002 amplifiers have the ability to operate in any one of the following modes:

Stereo (STACT / Mixed Mono); Use this mode for either stereo operation (left and right channels) or for Mixed Mono operation (stereo left and right channels plus bridged mono for a subwoofer).

Summed Mono: Use this mode to get a bridged mono output while using both the left and right inputs and gain controls.

Bridged Mono: Use this mode to get a bridged mono output while using only the right channel input and gain control (for use with a singular mono input).

Please follow the wiring schemes below for the correct operation:

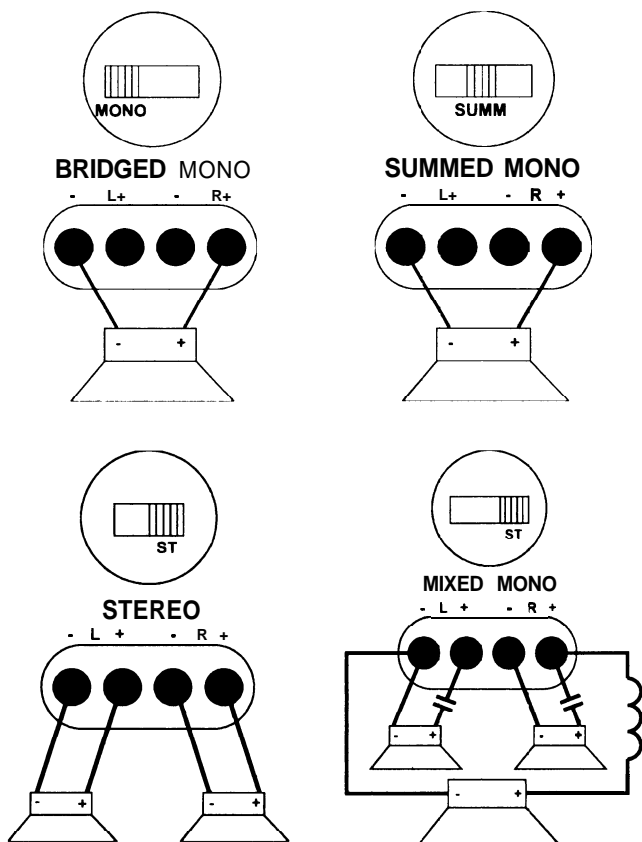

INSTALLATION STEP 2

BALANCED / UNBALANCED INPUT

The RUBICON502, 702 and 1002 amplifiers have the ability to accept either a standard Unbalanced RCA signal input, or a Balanced "Pro Audio" style input signals with the use of the Soundstream **BLT** Balanced Line Transmitter or some other balanced line audio source. Before installing your system, you should decide upon which signal type you wish to run, There are advantages to both:

	<i>UNBALANCED INPUT</i>	<i>BALANCED INPUT</i>
ADVANTAGES	<ol style="list-style-type: none"> 1. Most preamplifier / source units have Unbalanced RCA outputs (Industry Standard). 2. No Interface module is necessary. 	<ol style="list-style-type: none"> 1. Improved Signal to Noise Ratio (S/N Ratio). 2. Excellent noise cancellation characteristics. 3. Immune to noise radiated in the car audio environment.

The RUBICON amplifiers' signal inputs accept a wide range of input level: from 300 mVrms to 5.0 Vrms for both Balanced and Unbalanced inputs. For the best S/N Ratio, we recommend that the input level controls be set **as** far down as possible (rotated counter-clockwise), while maintaining an acceptable level of output.

Using the "Unbalanced" RCA Input

When using the Unbalanced RCA input, the RIGHT channel input signal switch MUST be in the "UNBAL" position. Also, when first installing the amplifier using this input configuration, we suggest that the left channel input signal switch be in the "UNBAL" position as well. If you experience alternator wane or other installation noise with both switches in the "UNBAL" position, try moving the LEFT channel input signal switch to the "BAL" Position. This should remove any system noise due to the installation.

Using the "Balanced" RCA Input

When using the Balanced 6-pin DIN audio input, both switches MUST be in the "BAL" position. Also, we recommend that when using this input configuration, the input level controls be set to the "minimum" position (rotated counter-clockwise). The system gain should then be adjusted on the **BLT** Balanced Line Transmitter, other other balanced line audio source. For the pin configuration, see the diagram below:

NOTE: The pin configuration shown in the diagram is the view looking into the Balanced input jack on the amplifier.

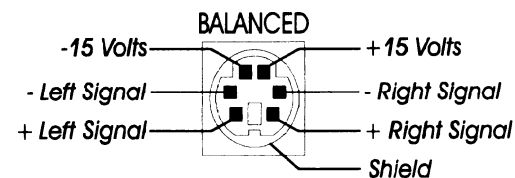

INSTALLATION STEP 3

WIRING

POWER AND GROUND

To ensure maximum output from your RUBICON amplifier, use high quality, low-loss power and ground cables and connections. The RUBICON amplifiers will accept up to 4 gauge power and ground cables. Determine from the chart below the minimum gauge power and ground wire for your application.

	<i>up to 10'</i>	<i>up to 20'</i>
RUBICON 502	4 or 8 gauge	4 gauge only
RUB/CON 702	4 or 8 gauge	4 gauge only
RUB/CON 1002	4 gauge only	4 gauge only

CIRCUIT BREAKERS AND FUSES

EXTERNAL

Like all audio components, the RUBICON amplifiers must be fused near the battery. A fuse or circuit breaker must be located within 18" of the battery. This will prevent a fire in the event of a shorted cable. See the chart below to determine the correct fuse value.

INTERNAL

The RUBICON amplifiers are fused with an automotive-type or Maxi-fuse. In the event of a blown power supply fuse(s), replace with the correct value fuse found in the chart below. Never replace the fuse with a higher value than what is supplied. This may result in amplifier damage and will void the warranty!

RUB/CON Amplifier Fuse Values

	<i>Amplifier Fuse</i>	<i>Battery Fuse / Circuit Breaker</i>
RUBICON 502	(2) 30 amp automotive	80 amp
RUB/CON 702	60 amp Maxi-fuse	80 amp
RUB/CON 1002	80 amp Maxi-fuse	100 amp

REMOTE TURN-ON

Connect the "Remote" line to the turn-on lead from the source unit. When +12 Volts is received, the amplifier will turn on.

SIGNAL CABLE

Use a high quality cable that will be easy to install and has minimal signal loss to guarantee optimum performance.

SPEAKER CABLE

The RUBICON amplifiers will accept up to 8 gauge speaker cable. Use a high quality, flexible, multi-strand cable for best performance and longevity.

SAMPLE WIRING DIAGRAM

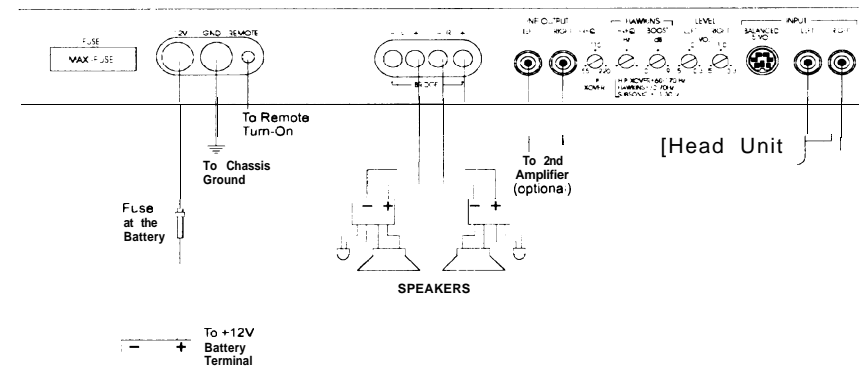

INSTALLATION STEP 4

INSTALLATION AND MOUNTING

AMPLIFIER LOCATION

The RUBICON amplifiers employ highly efficient circuitry, a custom-engineered heat sink, and a unique Chassisink construction to maintain lower operating temperatures. Additional cooling may be required if the amplifier is **located** in a tightly confined area or when driving especially low impedance loads at extremely high levels.

When mounting the amplifier, it should be securely mounted to either a panel in the vehicle or an amp board or rack that is securely mounted to the vehicle. The mounting location should be either in the passenger compartment or in the trunk of the vehicle, away from moisture, stray or moving objects, and major electrical components. To provide adequate ventilation, mount the amplifier so that there are at least two inches of freely circulating air above and to the sides of it.

MOUNTING THE AMPLIFIER

- a. Using the amplifier as a template, mark the holes on the mounting surface.
- b. Remove the amplifier and drill the holes for the mounting screws.
- c. Secure the amplifier to the mounting surface using the supplied hardware.

WIRING

- a. Run and connect the audio signal and remote turn-on cables to the amplifier from the source unit.
- b. Carefully run the positive cable from the amplifier to a fuse or circuit breaker within 18" of the battery.
- c. Connect the fuse or circuit breaker lead to the battery. Leave the circuit breaker off or the fuse out until everything is bolted down.
- d. Secure the ground cable to a solid chassis ground on the vehicle. It may be necessary to sand paint down to raw metal for a good connection.
- e. Double check each and every connection!
- f. Re-connect the fuse or circuit breaker.

POWER UP

Power up the system, there may be a 2-3 second delay from the time the source unit is turned on to the time that the amplifier turns on, which is normal. Once the **amplifier** LED is on and the source unit is playing, you should have sound coming from the speakers.

INSTALLATION STEP 5

LEVEL SETTING

The input levels are adjusted by means of the individual channel input level controls located on the front of the amplifier. This is a unique dual-stage circuit that adjusts both level and gain. This topology maintains better S/N Ratio even when using sources with minimal output.

In the ideal situation, all components in the audio system reach maximum undistorted output at the same time. If you send a distorted signal to an amplifier, it is simply going to amplify distorted information. The same holds true if an outboard processor or crossover begins to distort before you have maximum output from the amplifier. By setting all components to reach clipping at the same time, you can maximize the output of your system. For the RUBICON amplifiers, follow these steps for setting the input levels:

1. Turn the amplifiers' input levels to minimum position (counter-clockwise)
2. Set the source unit volume to approximately $\frac{3}{4}$ of full volume.
3. While playing dynamic source material, slowly increase the amplifiers' input level until a near maximum undistorted level is heard in the system.

The clipping indicators on the top of the amplifier let you know when the output of the amplifier is reaching its maximum level, and has begun to clip.

FRONT SPOILER

Once the amplifier is installed and the proper levels set, place the front spoiler in position, and secure it on using the supplied hardware.

TRIDENT PROTECTION CIRCUITRY

Your Rubicon amplifier is protected against both overheating and short circuits by means of main power fuses and the following circuits:

- ◆ Auto High Current power supply
- ◆ Speaker Output Protection
- ◆ Ground Fault Differential
- ◆ Smart Power Supply Thermal Rollback & a Thermal Protection Circuit

NOTE: If you experience blown main power supply fuses, it is likely that the amplifier is seeing a dead short, either in the speaker wire or in the speaker itself. Rectify the problem before blowing multiple fuses! DO NOT increase values beyond the original fuse value! Doing so will void your warrant and may damage your amplifier.

TROUBLESHOOTING

PROBLEM	CAUSE
No Sound and power LED is not lit	1. No power or ground at the amp. 2. No remote turn-on signal 3. Blown fuse near the battery
No sound, power LED is lit.	1. No signal input 2. The AIRBASS/Accessory switch is in the "IN" position. Move it to the "OUT" position.
Repeatedly blow amp fuse; frequent activation of Smart Power Supply Circuit	1. Speaker or leads may be shorted 2. Verify adequate amp ventilation
Not enough input sensitivity while using the Balanced Input	Be sure both Left and Right input signal switches are set to the "BAL" position.
Very little output, or output is muffled.	Make sure that both the L.P. and the H.P. crossvers aren't engaged
Left and Right "Clip" indicators lighting	Output signal level is too high and the amplifier output is clipping. Reduce the level either at the source or at the input level controls.
Alternator whine while using Unbalanced RCA inputs	1. Make sure the Right Input Signal Switch is in the "UNBAL" position. 2. Try the Left Input Signal switch in the "BAL" and "UNBAL" position: leave the switch in the quietest setting. This will not effect the performance of the amplifier.

SERVICE

Your Soundstream RUBICON amplifier is protected by a limited warranty. Please read the enclosed warranty card for details.

SPECIFICATIONS

POWER	4 Ω Stereo (8 Ω Bridged) (12.6 Vdc)	2 Ω Stereo (4 Ω Bridged) (14.4 Vdc)	1 Ω Stereo (2 Ω Bridged) (14.4 Vdc)	Maximum Rated output
502	100W x2 (200W x 1)	250W x 2 (500W x 1)	250W x 2 (500W x 1)	500 Watts
702	150W x 2 (300W x 1)	350W x 2 (700W x 1)	350W x 2 (700W x 1)	700 Watts
1002	200W x 2 (400W x 1)	500W x 2 (1000W x 1)	500W x 2 (1000W x 1)	1000 Watts

THD	<0.1%
Signal to Noise	>100 dB
Frequency Response	20 Hz to 20 kHz ± 0.5 dB
Stereo Separation	>90 dB
Damping	>200
input Sensitivity	300 mV to 5.0 Volts
Input Impedance	10k Ohms

Crossover Specifications

Low Pass: 55 Hz - 220 Hz at 24 dB/Octave

High Pass: 70 Hz - 160 Hz at 12 dB/Octave

Hawkins Bass Control

Sub Sonic Filter: No boost, High Pass filter from 13 to 30 Hz.

Hawkins Bass Control: 0 to +9 dB Boost; Boost and Sub Sonic filter, variable from 30 to 70 Hz.

Dimensions (W x D x H)

RUBICON502: 11 .0" X 9.8" X 2.25"

RUBICON702: 13.0" X 9.8" X 2.25"

RUBICON1002: 15.0" X 9.8" X 2.25"