

# TOSHIBA

*OWNER'S MANUAL*

## 3LCD DATA PROJECTOR

---

### TLP-X2000

### TLP-XC2000 (With Document Camera)

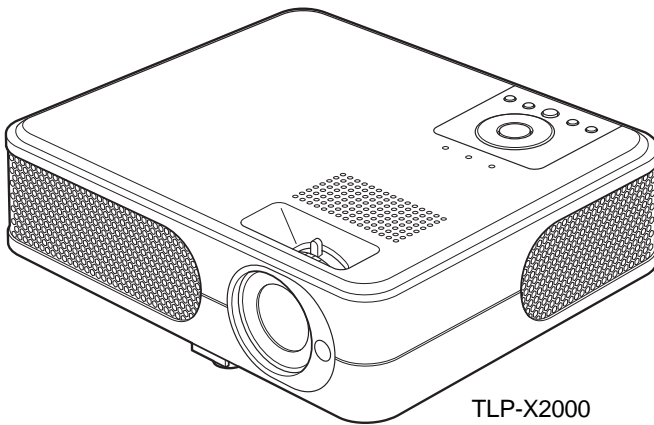

TLP-X2000

Before Using

Preparations

Operations

Maintenance

Others

# SAFETY PRECAUTIONS



The lightning flash with arrowhead symbol, within an equilateral triangle, is intended to alert the user to the presence of uninsulated "dangerous voltage" within the product's enclosure that may be of sufficient magnitude to constitute a risk of electric shock to persons.



The exclamation point within an equilateral triangle is intended to alert the user to the presence of important operating and maintenance (servicing) instructions in the literature accompanying the appliance.

**WARNING:** TO REDUCE THE RISK OF FIRE OR ELECTRIC SHOCK, DO NOT EXPOSE THIS APPLIANCE TO RAIN OR MOISTURE. DANGEROUS HIGH VOLTAGES ARE PRESENT INSIDE THE ENCLOSURE. DO NOT OPEN THE CABINET. REFER SERVICING TO QUALIFIED PERSONNEL ONLY.

**WARNING:** Handling the cord on this product or cords associated with accessories sold with this product, will expose you to lead, a chemical known to the State of California to cause birth defects or other reproductive harm. **Wash hands after handling.**

**WARNING:** This [product] contains mercury. Disposal of mercury may be regulated due to environmental considerations. For disposal or recycling information, please contact your local authorities or the Electronic Industries Alliance: [www.eiae.org](http://www.eiae.org).

**MODEL NAME: TLP-X2000** **USA only**

TRADE NAME: DATA PROJECTOR

MODEL NAME: TLP-X2000



Tested To Comply

With FCC Standards

FOR HOME OR OFFICE USE

**FCC NOTICE:** This device complies with part 15 of the FCC Rules. Operation is subject to the following two conditions:

(1) This device may not cause harmful interference, and (2) this device must accept any interference received, including interference that may cause undesired operation.

This equipment has been tested and found to comply with the limits for a Class B digital device, pursuant to part 15 of the FCC Rules. These limits are designed to provide reasonable protection against harmful interference in a residential installation. This equipment generates, uses and can radiate radio frequency energy and, if not installed and used in accordance with the instructions, may cause harmful interference to radio communications.

However, there is no guarantee that interference will not occur in a particular installation.

If this equipment does cause harmful interference to radio or television reception, which can be determined by turning the equipment off and on, the user is encouraged to try to correct the interference by one or more of the following measures:

- Reorient or relocate the receiving antenna.
- Increase the separation between the equipment and receiver.
- Connect the equipment into an outlet on a circuit different from that to which the receiver is connected.
- Consult the dealer or an experienced radio/TV technician for help.

RESPONSIBLE PARTY: TOSHIBA AMERICA INFORMATION SYSTEMS, INC.  
9740 Irvine Blvd., Irvine, CA 92618-1697 U.S.A  
Phone: (949) 583-3000

**WARNING:** Changes or modifications made to this equipment, not expressly approved by Toshiba, or parties authorized by Toshiba, could void the user's authority to operate the equipment.

**Notice:** This Class B digital apparatus complies with Canadian ICES-003. Cet appareil numérique de la classe B est conforme à la norme NMB-003 du Canada.

## MODEL NAME: TLP-XC2000

FCC Radio Frequency Interference Statement

**Note:** This equipment has been tested and found to comply with the limits for a Class A digital device, pursuant to part 15 of the FCC Rules. These limits are designed to provide reasonable protection against harmful interference when the equipment is operated in a commercial environment. This equipment generates, uses, and can radiates radio frequency energy and, if not installed and used in accordance with the instruction manual, may cause harmful interference to radio communications. Operation of this equipment in a residential area is likely to cause harmful interference in which case the user will be required to correct the interference at his own expense.

**WARNING:** Changes or modifications made to this equipment, not expressly approved by Toshiba, or parties authorized by Toshiba, could void the user's authority to operate the equipment.

**Notice:** This Class A digital apparatus complies with Canadian ICES-003. Cet appareil numérique de la classe A est conforme à la norme NMB-003 du Canada.

**WARNING:** This is a Class A product. In a domestic environment this product may cause radio interference in which case the user may be required to take adequate measures.

# IMPORTANT SAFETY INSTRUCTIONS

**CAUTION: PLEASE READ AND OBSERVE ALL WARNINGS AND INSTRUCTIONS GIVEN IN THIS OWNER'S MANUAL AND THOSE MARKED ON THE UNIT. RETAIN THIS BOOKLET FOR FUTURE REFERENCE.**

This unit is fully transistorized and does not contain any parts that can be repaired by the user.

**DO NOT REMOVE THE CABINET COVER, OR YOU MAY BE EXPOSED TO DANGEROUS VOLTAGE. REFER SERVICING TO QUALIFIED SERVICE PERSONNEL ONLY.**

## 1. Read Owner's Manual

After unpacking this product, read the owner's manual carefully, and follow all the operating and other instructions.

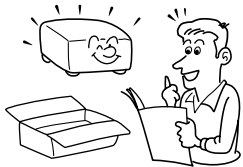

## 2. Power Sources

This product should be operated only from the type of power source which does not exceed the voltage range specified on the rating label and the power cord. If you are not sure of the type of power supply to your home, consult your product dealer or local power company.



## 3. Source of Light

Do not look into the lens while the lamp is on. The strong light from the lamp may cause damage to your eyes or sight.

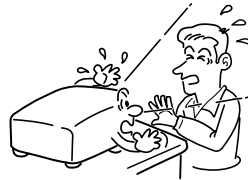

## 4. Ventilation

Openings in the cabinet are provided for ventilation and to ensure reliable operation of the product and to protect it from overheating, and these openings must not be blocked or covered. The openings should never be blocked by placing the product on a bed, sofa, rug or other similar surface. This product should not be placed in a built-in installation such as a bookcase or rack unless proper ventilation is provided.

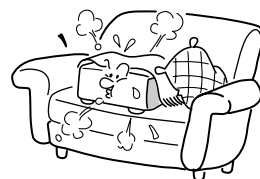

## 5. Heat

The product should be situated away from heat sources such as radiators, heat registers, stoves, or other products (including amplifiers) that produce heat.

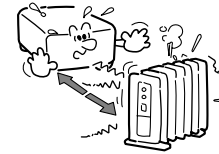

## 6. Water and Moisture

Do not use this product near water. - for example, near a bath tub, wash bowl, kitchen sink, or laundry tub; in a wet basement; or near a swimming pool and the like.

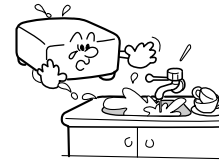

## 7. Cleaning

Unplug this product from the wall outlet before cleaning. Do not use liquid cleaners or aerosol cleaners. Use a soft cloth for cleaning.

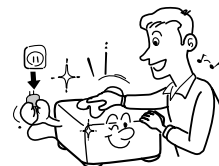

## 8. Power-Cord Protection

Power-supply cords should be routed so that they are not likely to be walked on or pinched by items placed upon or against them, paying particular attention to cords at plugs, convenience receptacles, and the point where they exit from the product.



## 9. Overloading

Do not overload wall outlets; to reduce the risk of electric shock, do not use the polarized plug with an extension cord, receptacle, or other outlet unless the blades can be inserted completely with three-wire grounding type to prevent blade exposure. As this can result in a risk of fire or electric shock.



## IMPORTANT SAFETY INSTRUCTIONS (Continued)

### 10. Lightning storms

For added protection for this product during storm, or when it is left unattended and unused for long periods of time, unplug it from the wall outlet. This will prevent damage to the product due to lightning and power-line surges. However, while it is thundering or lightning, do not touch the apparatus and any connected cable and/or equipment. This will prevent you from receiving the electric shock by an electric surge.

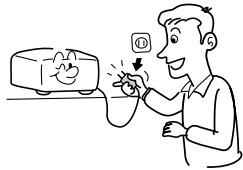

### 11. Object and Liquid Entry

Never push objects of any kind into this product through openings as they may touch dangerous voltage points or short-out parts that could result in a fire or electric shock. Never spill liquid of any kind on the product.



### 12. Do not place the product vertically

Do not use the product in the upright position to project the pictures at the ceiling, or any other vertical positions. It may fall down and dangerous.

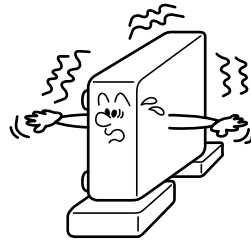

### 13. Stack Inhibited

Do not stack other equipment on this product or do not place this product on the other equipment. Top and bottom plates of this product develops heat and may give some undesirable damage to other unit.



### 14. Attachments

Do not use attachments not recommended by the product manufacturer as they may cause hazards.

### 15. Accessories

Do not place this product on an unstable cart, stand, tripod, bracket, or table. The product may fall, causing serious injury to a child or adult, and serious damage to the product. A product and cart combination should be moved with care. Quick stops, excessive force, and uneven surfaces may cause the product and cart combination to overturn.



### 16. Damage Requiring Service

Unplug this product from the wall outlet and refer servicing to qualified service personnel under the following conditions:

- When the power-supply cord or plug is damaged.
- If liquid has been spilled, or objects have fallen into the product.
- If the product has been exposed to rain or water.
- If the product does not operate normally by following the operating instructions. Adjust only those controls that are covered by the operating instructions as an improper adjustment of other controls may result in damage and will often require extensive work by a qualified technician to restore the product to its normal operation.

- If the product has been dropped or damaged in any way (If the cabinet should break, please handle with care to avoid injury) .
- When the product exhibits a distinct change in performance - this indicates a need for service.

### 17. If glass components, including lens and lamp, should break, contact your dealer for repair service.

This product incorporates glass components, including a lens and a lamp. If such parts should break, please handle with care to avoid injury and contact your dealer for repair service. The broken pieces of glass may cause to injury. In the unlikely event of the lamp rupturing, thoroughly clean the area around the projector and discard any edible items placed in that area.

### 18. Servicing

Do not attempt to service this product yourself as opening or removing covers may expose you to dangerous voltage or other hazards. Refer all servicing to qualified service personnel.



## IMPORTANT SAFETY INSTRUCTIONS (Continued)

### 19. Replacement Parts

When replacement parts are required, be sure the service technician has used replacement parts specified by the manufacturer or have the same characteristics as the original part. Unauthorized substitutions may result in fire, electric shock, or other hazards. (Replacement of the lamp only should be made by users.)

### 20. Safety Check

Upon completion of any service or repairs to this product, ask the service technician to perform safety checks to determine that the product is in proper operating condition.

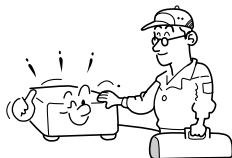

### 21. Do not leave thermal-paper documents or easily deformed items on top of the unit or near the air exhaust for long periods of time.

The heat from the unit could erase the information on the thermal paper, or cause deformation or warping.

### 22. Do not use the product in a closed installation state.

Do not place the product in a box or in any other closed installation state. Otherwise it may overheat. This could result in a risk of fire.

### 23. Do not look into the laser light source of the remote control or direct the laser pointer toward a person or a mirror.

The laser beam may cause damage to the eyes or sight.

### 24. Do not get your hands between the camera arm and the main unit when setting the camera arm back in its original position. (Models equipped with document camera)

To avoid injury, be careful not to get your hands caught when setting the camera arm back in its original position. Families with children should be particularly careful.

### 25. Do not carry by the camera arm. (Models equipped with document camera)

Do not carry the projector by the camera arm. Doing so can result in damage or injury.

### 26. Do not move the projector while the arm is still erect. (Models equipped with document camera)

Always store the arm back in position when moving the projector. Otherwise injury or damage may result.

## POWER SUPPLY CORD SELECTION

If your line voltage is 220 to 240V, use one of the following types of cable.

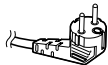
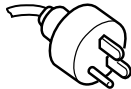
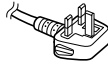
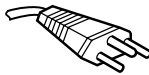
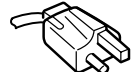
| Plug configuration  | Plug type | Line voltage | Plug configuration  | Plug type               | Line voltage |
|---|-----------|--------------|---|-------------------------|--------------|
|  | EURO      | 220 – 240V   |  | Australian 240V 10A     | 200 – 240V   |
|  | UK        | 220 – 240V   |  | Switzerland 240V 6A     | 200 – 240V   |
|   |           |              |  | North American 240V 15A | 200 – 240V   |

Use a 5A fuse which is approved by ASTA or BSI to BS1362. Always replace the fuse cover after changing the fuse.

## IMPORTANT PRECAUTIONS

### Save Original Packing Materials

The original shipping carton and packing materials will come in handy if you ever have to ship your projector. For maximum protection, repack the set as it was originally packed at the factory.

### Moisture Condensation

Never operate this unit immediately after moving it from a cold location to a warm location. When the unit is exposed to such a change in temperature, moisture may condense on the lens and the crucial internal parts. To prevent the unit from possible damage, do not use the unit for at least 2 hours when there is an extreme or sudden change in temperature.

### Place and Manner of Installation

- Do not place in hot locations, such as near heating equipment. Doing so could cause malfunction, and shorten the life of the projector.
- Avoid locations with oil or cigarette smoke. Doing so will dirty the optical parts, shortening their lives, and darkening the screen.
- Do not use this product in the upright position or tilt it up or down by more than 20° from level. Doing so may cause a failure or shorten the life of the product.
- Using this instrument near a TV or radio may cause interference to the images or audio sound. If this happens, move it away from the TV or radio.
- Moving the projector from a low-temperature room to a high-temperature room may cause condensation on the lens or internal parts in the instrument. If you continue to use it in that situation, the malfunction may result. Ensure to wait until the condensation naturally disappears.
- In a high altitude location where air is thin, cooling efficiency is reduced so use the projector with **[Fan mode]** set to **[High]**. [p.43](#)

## IMPORTANT PRECAUTIONS (Continued)

### Avoid Volatile Liquid

Do not use volatile liquids, such as an insect spray, near the unit. Do not leave rubber or plastic products touching the unit for a long time. They will leave marks on the finish. If cleaning with a chemically saturated cloth, be sure to follow the product's precautions.

### LCD Panel

- If the air filter is stained and is clogged up, the main unit inner temperature rises. As a result, the life of the LCD is shortened and a malfunction may also occur. Clean the air filter from time to time and replace it regularly. It is recommended that this replacement be done at the time of replacing a lamp. (Ask a dealer where the unit was purchased or your nearby service station about an air filter for replacement.)

## EXEMPTION CLAUSES

- Toshiba Corporation bears no responsibility in the case of damages arising from natural disaster such as earthquakes, lightning, etc., fire not liable to Toshiba Corporation, acts by third parties, other accidents, or use under abnormal conditions including erroneous or improper operation and other problems.
- Toshiba Corporation bears no responsibility for incidental damages (lost profit, work interruption, corruption or loss of the memory contents, etc.) arising from the use of or the inability to use this unit.
- Toshiba Corporation accepts no liability whatsoever for any damages arising from not having followed the descriptions in this Instruction Manual.
- Toshiba Corporation accepts no liability whatsoever for any damages arising from malfunctions arising from combination with equipment or software that is not related to Toshiba Corporation.

## OTHER CAUTIONS AND INFORMATIONS

### Copyrights

Showing or transmitting commercial imaging software or broadcast or cable-broad casting programs with the purpose of other than the personal and private viewing, including modifying images using the freeze or resize functions, or displaying with the varying aspect ratio of the images, could violate the direct or indirect copyrights of the imaging software or broadcast program, etc., if done without first consulting with the copyright holder. For this reason, please take appropriate measures before performing one of the actions listed above, including obtaining a license from the copyright holder.

In the spaces provided below, record the Model and Serial No. located at the bottom of your projector.

Model No. \_\_\_\_\_ Serial No. \_\_\_\_\_

Retain this information for future reference.

### Disposal

This product contains substances which are harmful to humans and the environment.

- The lamp contains mercury.

Please dispose of this product or used lamps in accordance with local regulations.

**Following information is only for EU-member states:**

The use of the symbol indicates that this product may not be treated as household waste. By ensuring this product is disposed of correctly, you will help prevent potential negative consequences for the environment and human health, which could otherwise be caused by inappropriate waste handling of this product. For more detailed information about recycling of this product, please contact your local city office, your household waste disposal service or the shop where you purchased the product.



### Trademarks

- VGA, SVGA, XGA, SXGA, UXGA are trademarks or registered trademarks of International Business Machines Corporation.
- Macintosh is a registered trademark of Apple Computer, Inc.
- Windows is a registered trademark of Microsoft Corporation in the U.S. and other countries.
- Adobe is a registered trademark and Acrobat Reader is a trademark of Adobe Systems Incorporated.

### Notational Conventions Used in This Manual

- References to pages with related information are annotated as follows. For example, if making a reference to page 36: [p.36](#)
- The illustrations in this document are for reference purposes only and may not reflect your package exactly.

## REMOTE CONTROL BATTERIES

### Caution

- Never throw batteries into a fire.

Using the batteries improperly may cause them to explode or leak and lead to burn or injury. If battery-leaking fluid contacts skin, wash the fluid off immediately with clean water and consult a doctor. If the fluid is spilt on an instrument, avoid contact and wipe it off using tissue paper. (Dispose of the used tissue paper as flammable garbage after moistening with water.)

### Notes

- Be sure to use AAA (LR03) size batteries.
- Dispose of batteries in a designated disposal area.
- Attention should be drawn to the environmental aspects of battery disposal.
- Do not mix different battery types or combine used batteries with new ones.
- If the remote control does not operate correctly, or if the operating range becomes reduced, replace both batteries with new ones.
- If the batteries are dead or if you will not be using the remote control for a long time, remove the batteries to prevent battery acid from leaking into the battery compartment.

# CONTENTS

## Before Using

|                                       |    |
|---------------------------------------|----|
| SAFETY PRECAUTIONS .....              | 2  |
| IMPORTANT SAFETY INSTRUCTIONS .....   | 4  |
| POWER SUPPLY CORD SELECTION .....     | 9  |
| IMPORTANT PRECAUTIONS .....           | 9  |
| EXEMPTION CLAUSES .....               | 10 |
| OTHER CAUTIONS AND INFORMATIONS ..... | 10 |
| REMOTE CONTROL BATTERIES .....        | 11 |
| CONTENTS .....                        | 12 |

## Preparations

|   |    |
|---|----|
| Checking the package contents .....                                       | 14 |
| Names of each part on the main unit .....                                 | 15 |
| Names of each part on the control panel and remote control .....          | 16 |
| Names of the terminals on the rear panel .....                            | 18 |
| Names of part on the document camera (models with a document camera) .... | 19 |
| Preparing and using the remote control .....                              | 20 |
| Operating a computer using the remote control .....                       | 21 |
| Placement .....   | 22 |
| Connection .....  | 23 |
| Label locations .....   | 24 |

## Operations

|  |    |
|--|----|
| Turning the power on and off .....                         | 25 |
| Basic operations .....                                     | 27 |
| Using handy features .....                                 | 29 |
| Using auto setting .....                                   | 29 |
| Correcting the keystone distortion .....                   | 29 |
| Resizing image .....                                       | 30 |
| Cutting off the picture and sound temporarily (Mute) ..... | 31 |
| Changing picture mode .....                                | 31 |
| Changing screen size .....                                 | 32 |
| Freezing the image (Freeze) .....                          | 32 |
| Setting the password .....                                 | 33 |
| Using the menus .....                                      | 36 |
| How to use the menus .....                                 | 36 |
| The image adjustment menu .....                            | 37 |
| The display setting menu .....                             | 39 |
| The default setting menu .....                             | 42 |
| Displaying Information (Status display) .....              | 44 |
| Using the document camera .....                            | 45 |
| Preparation of the document camera .....                   | 45 |
| Image projection with the document camera .....            | 46 |
| Locking the white balance .....                            | 48 |

## Maintenance

|                                   |    |
|-----------------------------------|----|
| About lamp .....                  | 49 |
| Lamp replacement .....            | 50 |
| Air filter cleaning .....         | 52 |
| Lens and main unit cleaning ..... | 53 |

## Others

|   |    |
|---|----|
| Trouble indications .....   | 54 |
| Before calling service personnel .....  | 55 |
| Specifications .....  | 56 |
| List of general specifications .....  | 56 |
| Document camera specifications (Models equipped with document camera) ...       | 56 |
| List of supported signals (RGB signals) .....                                   | 57 |
| List of supported signals (Y/Pb/Pr signals) .....                               | 58 |
| List of supported signals (Video, S-Video signals) .....                        | 58 |
| Pin assignment of COMPUTER 1 IN, COMPUTER 2 IN &<br>MONITOR OUT terminals ..... | 58 |
| CONTROL terminal .....  | 59 |
| Separately sold product .....   | 59 |

## Checking the package contents

Please make sure that the following items are included in the box, along with the main unit. If any item is missing, please contact the store immediately where you purchased the product.

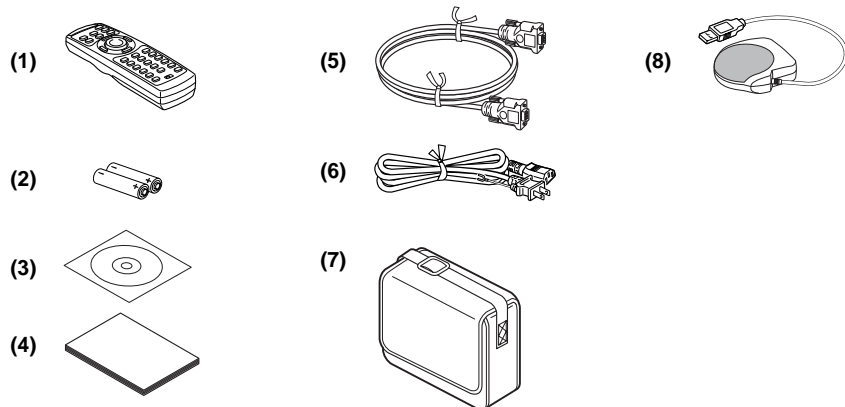

- (1) Remote control
- (2) LR03 (SIZE AAA) batteries for remote control (2)
- (3) CD-ROM
- (4) Owner's Manual
- (5) RGB cable (3m)
- (6) Power cord (See note)
- (7) Carrying bag
- (8) Mouse remote control receiver

### Note

The shape and number of supplied power cords vary depending on the product destination.

### ◆The Supplied CD-ROM

The supplied CD-ROM contains an owner's manual, including information not available for the printed Owner's manual (Getting started) and Acrobat® Reader™ to view the manual.

### ■ Installing Acrobat® Reader™

(Not necessary if Acrobat® Reader™ has already been installed in your computer)

Windows®: Run the CD-ROM, select the **Reader/English** folder, and run **ar500enu.exe**. Follow the on-screen instructions.

Macintosh: Run the CD-ROM, select the **Reader/English** folder, and run **Reader Installer**. Follow the on-screen instructions to install the software.

### ■ Viewing the manual

Run the CD-ROM and double-click on **Start.pdf**. Acrobat® Reader™ launches, and the menu screen of the Owner's manual appears. Click on your language. The Owner's Manual cover and list of bookmarks appear. Click on a bookmark title to view that section of the manual. Click on [p. 20](#) to view a reference page with related information. See the Help menu for more information about Acrobat® Reader™.

## Names of each part on the main unit

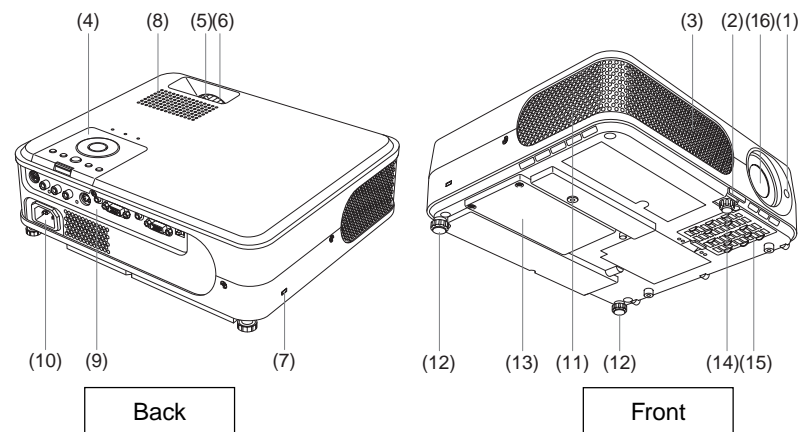

| Name                             | Function   |
|----------------------------------|--|
| (1) Infrared remote sensor       | : Senses commands from the remote control. <a href="#">p.20</a>            |
| (2) Foot adjuster release button | : Press to set up or stow the foot adjuster. <a href="#">p.28</a>          |
| (3) Air intake                   | : Draws in air from outside the projector.                                 |
| (4) Control panel                | : Operates the projector. <a href="#">p.16</a>                             |
| (5) Zooming lever                | : Adjusts screen size. <a href="#">p.28</a>                                |
| (6) Focusing ring                | : Adjusts screen focus. <a href="#">p.28</a>                               |
| (7) Antitheft lock hole          | : Attach a safety cable or any other antitheft device.                     |
| (8) Speaker                      | : Outputs audio sound.   |
| (9) Terminals on the rear panel  | : Connects external devices. <a href="#">p.18</a>                          |
| (10) AC IN socket                | : Connect the supplied power cord here.                                    |
| (11) Air exhaust                 | : Expels air that has grown hot inside the projector.                      |
| (12) Tilt adjuster               | : Adjusts the projector's horizontal tilt. <a href="#">p.28</a>            |
| (13) Lamp cover                  | : Remove to replace lamp. <a href="#">p.50</a>                             |
| (14) Foot adjuster               | : Adjusts the vertical projection angle. <a href="#">p.28</a>              |
| (15) Air filter                  | : Prevents dirt and garbage from getting into the inside of the projector. |
| (16) Lens                        | : Projects expanded image.   |

### ■ How to detach the control panel

While Pressing the lock level in the direction of the arrow, lift the control panel.

### ■ How to attach the control panel

Align the convexity of the point of the control panel, and using the reverse order from detaching the control panel, insert the control panel until it is locked with a sound of click.

### ■ PRECAUTION

- Please keep the detached control panel with care so that it will not lost.
- Please prevent any sudden shock to the control panel, such as bumping, hitting, jolting, dropping, etc.
- As the control panel has not remote control feature, it can not work unless when attached to the main unit.
- You can operate with the remote control even when the control panel has been detached.

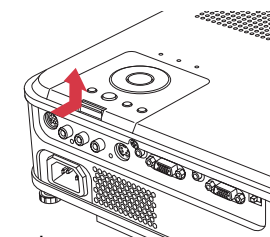



# Names of each part on the control panel and remote control

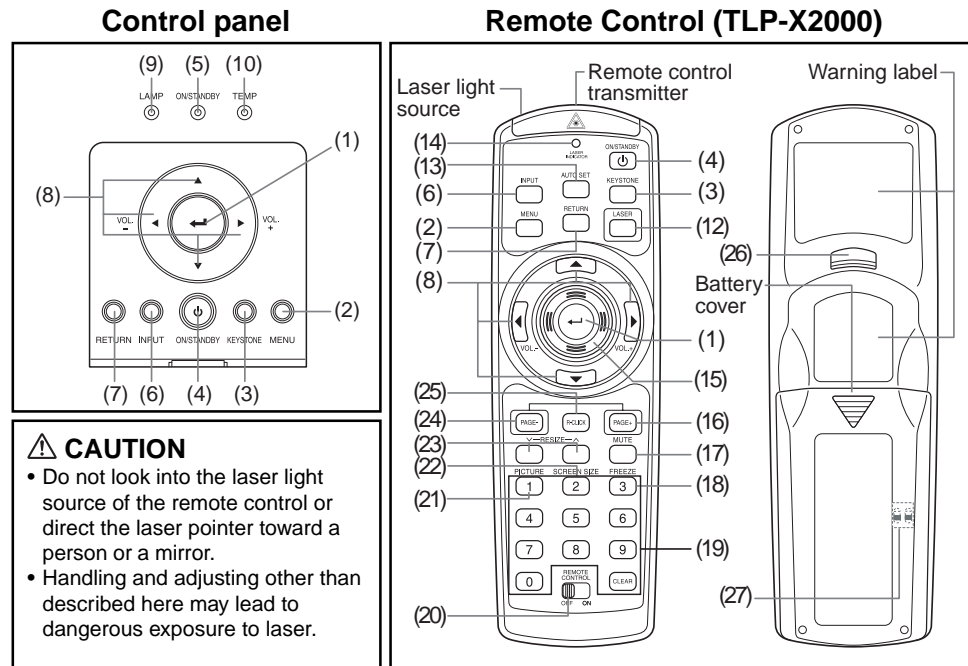

**CAUTION**

- Do not look into the laser light source of the remote control or direct the laser pointer toward a person or a mirror.
- Handling and adjusting other than described here may lead to dangerous exposure to laser.

Name : Main Function

## Control panel

- (1) ENTER button : Accepts the selected mode.
- (2) MENU button : Displays menus. [p.36](#)
- (3) KEYSTONE button : Adjusts keystone distortion. [p.29](#)
- (4) ON/STANDBY button : Turns the power on/off (standby). [p.25](#)
- (5) ON/STANDBY indicator : Displays whether power is on or off (standby). [p.25](#)
- (6) INPUT button : Selects input. [p.27](#)
- (7) RETURN button : Goes back one screen.
- (8) Selection button : Menu selections and adjustments, volume control, etc. [p.36](#)
- (9) LAMP indicator : Informs the abnormality of lamp. [p.54](#)
- (10) TEMP indicator : Informs the abnormality of internal temperature. [p.54](#)

## Remote control

- (1) ENTER button : Accepts the selected mode.
- (2) MENU button : Displays menus. [p.36](#)
- (3) KEYSTONE button : Adjusts keystone distortion. [p.29](#)
- (4) ON/STANDBY button : Turns the power on/off (standby). [p.25](#)
- (6) INPUT button : Selects input. [p.27](#)
- (7) RETURN button : Goes back one screen.
- (8) Selection button : Menu selections and adjustments, volume control, etc. [p.36](#)
- (12) LASER button : Shows a laser pointer.

- (13) AUTO SET button : Sets up input from computer. [p.29](#)
- (14) Laser indicator : Lights when laser is on.
- (15) Mouse control button : Controls a mouse pointer. [p.21](#)
- (16) PAGE+ button : Proceeds PowerPoint® slides. [p.21](#)
- (17) MUTE button : Cuts off the picture and sound temporarily. [p.31](#)
- (18) FREEZE button : Pauses image. [p.32](#)
- (19) Ten-Key button : Use when entering password.

| Remote control button | Input items | Remote control button | Input items            |
|-----------------------|-------------|-----------------------|------------------------|
| [1]                   | [1]         | [7]                   | [7]                    |
| [2]                   | [2]         | [8]                   | [8]                    |
| [3]                   | [3]         | [9]                   | [9]                    |
| [4]                   | [4]         | [0]                   | [0]                    |
| [5]                   | [5]         | [CLEAR]               | Deletes one character. |
| [6]                   | [6]         |                       |                        |

- (20) Remote control ON/OFF switch : Switches on/off the remote control. [p.21](#)
- (21) PICTURE button : Changes image mode. [p.31](#)
- (22) SCREEN SIZE button : Changes screen size. [p.32](#)
- (23) RESIZE button : Enlarges image. [p.30](#)
- (24) PAGE- button : Goes back PowerPoint® slides. [p.21](#)
- (25) R-CLICK button : Functions as right-click of a mouse. [p.21](#)
- (26) L-CLICK button : Functions as left-click of a mouse. [p.21](#)
- (27) Remote control code switch (inside the battery cover) : Sets the code of remote control to that of the projector. [p.43](#)

Name : Main Function

## Remote Control (TLP-XC2000)

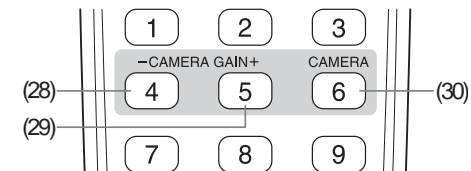

- (28) CAMERA GAIN- button : Adjusts the gain of the camera. [p.47](#)
- (29) CAMERA GAIN+ button : Adjusts the gain of the camera. [p.47](#)
- (30) CAMERA button : Switches between the camera input and the previous input. [p.46](#)

## Note

- For the remainder of this manual, buttons are referred to as follows:  
 Selection buttons ⇒ ; ENTER button ⇒

## Names of the terminals on the rear panel

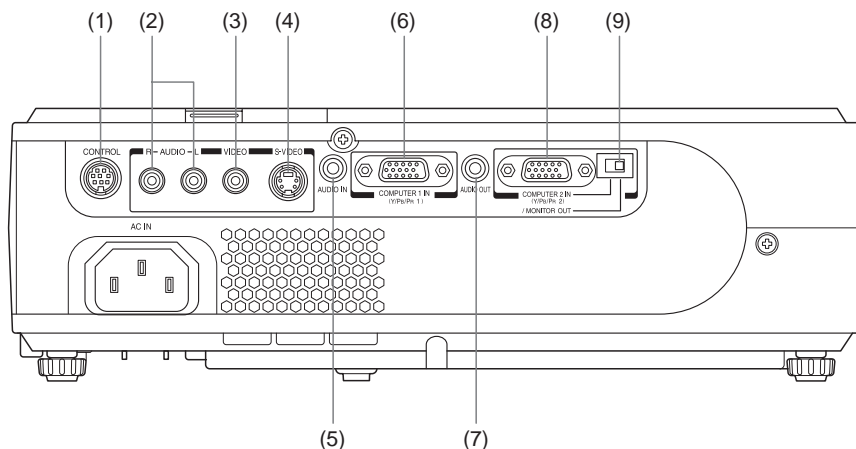

| Name   | Main Function   |
|--|---|
| (1) CONTROL terminal   | : When operating the projector via a computer, connect this to the controlling computer's RS-232C port. <a href="#">p.59</a>  |
| (2) AUDIO (L/R) terminal   | : Input audio signals from video equipment.   |
| (3) VIDEO terminal   | : Input video signals from video equipment.   |
| (4) S-VIDEO terminal   | : Input S video signals from video equipment.   |
| (5) AUDIO IN terminal  | : Input audio signals from a computer, or from video equipment with a component video signal output terminal.   |
| (6) COMPUTER 1 IN terminal   | : Input RGB signal from a computer or other source or a component video signal (Y/P <sub>B</sub> /P <sub>R</sub> ) from video equipment.  |
| (7) AUDIO OUT terminal   | : Outputs audio signals.  |
| (8) COMPUTER 2 IN terminal<br>(Also used for MONITOR OUT terminal) | : Inputs RGB signal from a computer or other source or a component video signal (Y/P <sub>B</sub> /P <sub>R</sub> ) from video equipment. It can also be used as MONITOR OUT terminal by the switch of (9). |
| (9) Switch   | : Switches between COMPUTER 2 IN and MONITOR OUT.   |

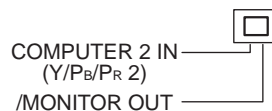

## Names of each part on the document camera (models with a document camera)

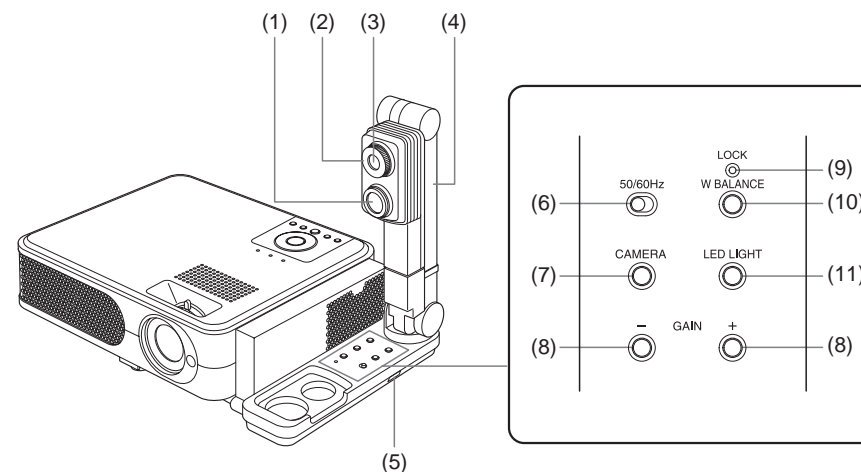

| Name                           | Main Function  |
|--------------------------------|--|
| <b>Camera</b>                  |  |
| (1) LED illumination           | : The illumination LED for referring documents. <a href="#">p.46</a>                           |
| (2) Focus ring                 | : Adjusts the focus. <a href="#">p.47</a>  |
| (3) Camera lens                | : The camera lens of the document camera.  |
| (4) Camera arm                 | : Adjusts the camera angle. <a href="#">p.45</a>   |
| (5) Infrared remote sensor     | : Senses commands from the remote control.   |
| <b>Control Panel</b>           |  |
| (6) 50/60 Hz switch            | : Matches the shutter speed of the camera to your power system frequency. <a href="#">p.47</a> |
| (7) CAMERA button              | : Switches between the camera input and the previous input. <a href="#">p.46</a>               |
| (8) CAMERA GAIN button         | : Adjusts the camera gain. <a href="#">p.47</a>  |
| (9) LOCK (W.BALANCE) indicator | : Lights when the white balance has been locked. <a href="#">p.48</a>                          |
| (10) W.BALANCE button          | : Switches between auto and locking of white balance. <a href="#">p.48</a>                     |
| (11) LED LIGHT button          | : Switches on/off the LED illumination. <a href="#">p.46</a>                                   |

# Preparing and using the remote control

## ■ Loading dry-cell batteries into the remote control

### ① Remove the battery cover.

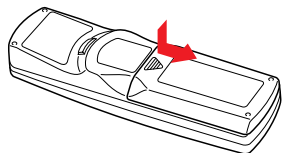

### ② Insert the dry-cell batteries.

Be sure to align the plus and minus ends of the batteries properly.

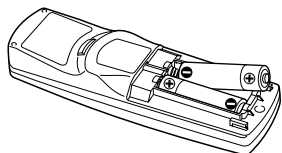

Two batteries (LR03, SIZE AAA) are used.

### ③ Replace the battery cover.

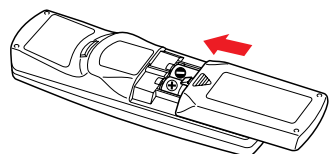

## ■ Dry-cell batteries

- Before using the batteries, be sure to observe the Safety Precautions described in previous pages.
- Remove batteries from remote control when not using for extended periods.
- If the remote control stops working, or if its range decreases, replace all the batteries with new ones.

## ■ The remote control

- When using more than 2 projectors, [Remote control] can make it possible to operate the remote control individually. [p.43](#)
- Turn off the ON/OFF switch of the remote control when not in use or to store in baggage.
- The remote control may fail to operate if the infrared remote sensor is exposed to bright sunlight or fluorescent lighting.
- Do not drop or bang.
- Do not leave in hot or humid locations.
- Do not get wet or place on top of wet objects.
- Do not take apart.
- In rare cases, ambient conditions could impede the operation of the remote control. If this happens, point the remote control at the main unit again, and repeat the operation.

## ■ Operating the remote control

Turn on the ON/OFF switch of the remote control.

Point toward the projector's infrared remote sensor, and press a button on the remote control.

- Operating the projector from the front

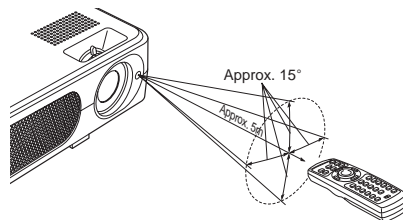

When operating the remote control from behind the projector, the light is reflected on the projecting surface and may travel a shorter distance to reach the projector depending on the shape and material of the projecting surface.

# Operating a computer using the remote control

A computer can be operated using the projector's remote control. This function is available on any computer with the Windows® 98/98SE, Windows® Me, Windows® 2000, or Windows® XP OS, that is equipped with a USB port which can support USB1.1 (The mouse remote control receiver is also supported on OS 9 or OS X for the Macintosh). However, please note that Toshiba does not guarantee the operation of all computers.

## ① Connecting a computer

Connect the mouse remote control receiver (supplied) to a computer.

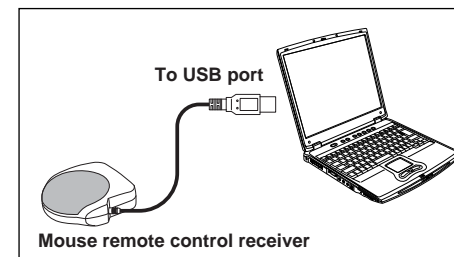

The remote control may fail to operate if the mouse remote control receiver is exposed to bright sunlight or fluorescent lighting.

In such a case, change position or direction of the mouse remote control receiver and retry.

## ② Operating a computer

Operate remote control's buttons towards the mouse remote control receiver.

### ● Moving the mouse pointer

Press the mouse control button in the direction you wish the mouse pointer to move, then press.

### ● To left click

Press the L-CLICK button.

### ● To right click

Press the R-CLICK button.

### ● To drag and drop

Holding down the L-CLICK button, move the mouse control button until the mouse pointer is over the desired location, then release the L-CLICK button.

### ● Using the computer's page up [↑] and down [↓] function

Press the PAGE+ and PAGE- buttons to switch PowerPoint® slides.

Remote Control Front

Remote Control Rear

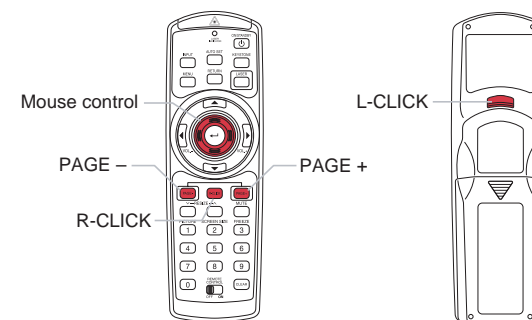

# Placement

## Placement Styles

As shown in the figures below, this device can be placed in 4 different styles. The factory setting is "floor-mounted front projection." Set the [Projection mode] in the **Default setting 2** menu, in accordance with your needs. [p.43](#)

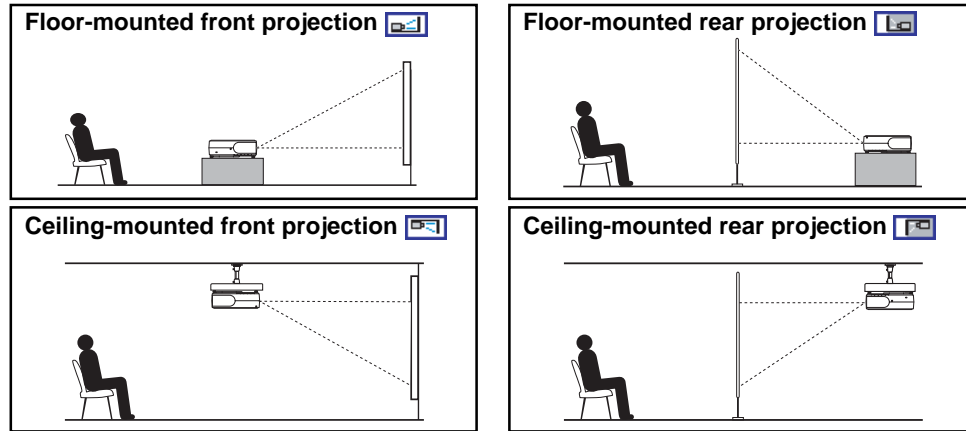

**WARNING**

- Always obey the instructions listed in IMPORTANT SAFETY INSTRUCTIONS when placing the unit. Attempting to clean/replace the lamp at a high site by yourself may cause you to drop down, thus resulting in injury.
- If you wish to mount the projector on the ceiling, be sure to ask your dealer to do so. Mounting the projector on a ceiling requires special ceiling brackets (sold separately) and specialized knowledge. Improper mounting could cause the projector to fall, resulting in an accident.
- If the projector is ceiling-mounted, install the breaker for turning off the power in case of anomaly. Let everyone involved with the use of the projector know that fact.

## Projection Distance and Size

Use the figures, tables, and formulas below to determine the projection size and projection distance. (Projection sizes are approximate values for full-size picture with no keystone adjustment.)

Screen **As seen from above**

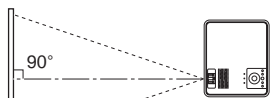

**As seen from the side**

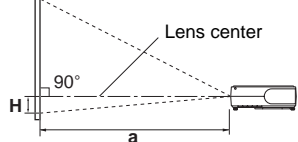

a is the distance (m) between the lens and the screen, and corresponds to a range of 1.19 m to 9.13 m. H is the height from the image bottom to the center of the lens.

$$a \text{ (min length)} = \frac{\text{projection size (inches)} - 0.8786}{32.773}$$

$$a \text{ (max length)} = \frac{\text{projection size (inches)} - 0.7244}{27.248}$$

| projection size (cm) | projection distance a (m) |                          | height (H) (cm) |
|----------------------|---------------------------|--------------------------|-----------------|
|                      | min length (zooming max)  | max length (zooming min) |                 |
| 33 (84)              | —                         | 1.19                     | 6.0             |
| 40 (102)             | 1.19                      | 1.44                     | 7.3             |
| 60 (152)             | 1.80                      | 2.18                     | 10.9            |
| 80 (203)             | 2.41                      | 2.91                     | 14.5            |
| 100 (254)            | 3.02                      | 3.64                     | 18.1            |
| 150 (381)            | 4.55                      | 5.48                     | 27.2            |
| 200 (508)            | 6.08                      | 7.31                     | 36.3            |
| 250 (635)            | 7.60                      | 9.15                     | 45.4            |
| 300 (762)            | 9.13                      | —                        | 54.4            |

# Connection

## Before connection

- Read the owner's manual of the device you are connecting to the projector.
- Some types of computer cannot be used or connected to this projector. Check for an RGB output terminal, supported signal [p.57](#), etc.
- Turn off the power of both devices before connecting.
- The figure is a sample connection. This does not mean that all of these devices can or must be connected simultaneously. (Dotted lines mean items can be exchanged.)

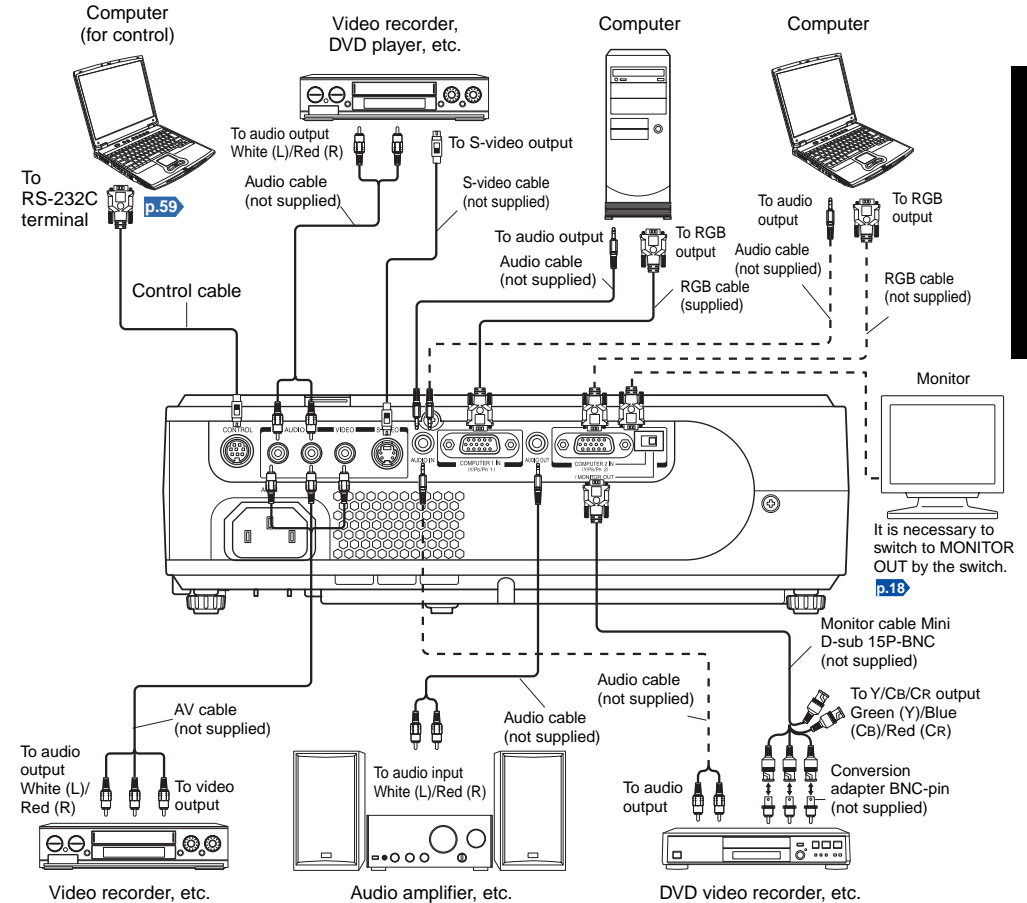

**Preparations**

It is necessary to switch to MONITOR OUT by the switch. [p.18](#)

## Connection (Continued)

### Notes

- When COMPUTER 2 IN terminal (also used for MONITOR OUT terminal) is used as MONITOR OUT terminal, the signal which is input to COMPUTER 1 IN terminal is output.
- Signals are output from MONITOR OUT terminal even in standby mode. However, from AUDIO OUT terminal, no audio signal is output.
- A computer monitor cannot accept Y/Pb/Pr signals correctly.
- The AUDIO IN terminal doubles for devices connected to COMPUTER 1 terminal and COMPUTER 2 terminal.
- When an AUDIO OUT terminal is connected, sound is not output from the projector speaker.
- Output volume of AUDIO OUT terminal can be adjusted by the **VOL** button.
- Moving pictures played back on computers using DVD software may appear unnatural if it is projected with this projector, but it is not a malfunction.

## Label locations

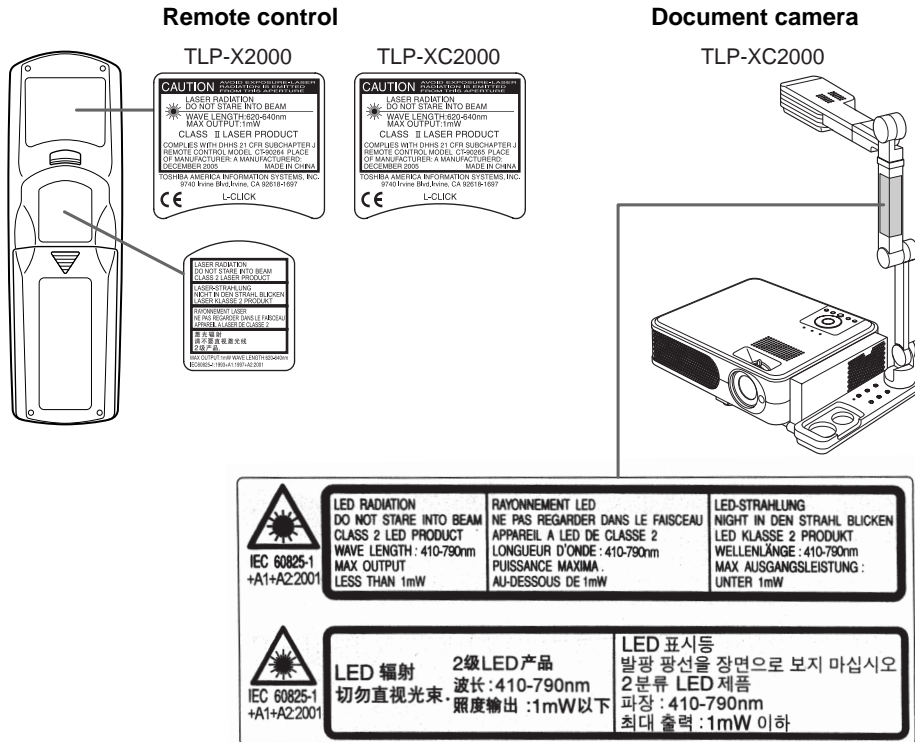

**Caution** – use of controls or adjustments or performance of procedures other than those specified herein may result in hazardous radiation exposure.

## Turning the power on and off

### Connecting the power cord

- 1 Insert the power cord connector into the AC IN socket of the projector.
- 2 Insert the power cord plug into a wall or other power outlet.

The ON/STANDBY indicator will change to orange, indicating standby mode.

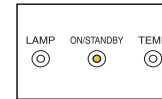
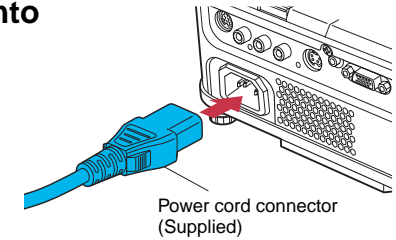

### Removing the lens cover

Be sure to remove the lens cover when the power is turned on. If it is left on, it could become deformed due to heat.

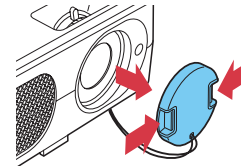

### Turning the power on

Press the ON/STANDBY button.

When the beep sound is [On], the projector beeps, the power turns on, and the ON/STANDBY indicator lights in green. After a moment, the start-up screen appears.

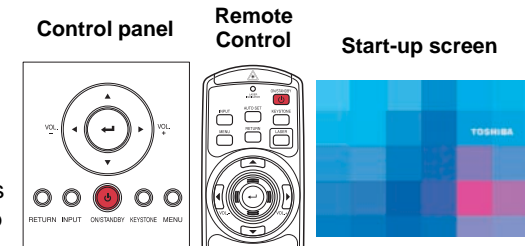

### CAUTION

- Do not look into the lens while the lamp is on. The strong light from the lamp may cause damage to your eyes or sight.
- Do not block the air intake or exhaust. Doing so could cause a fire due to internal overheating.
- Do not place your hands, face, or other objects near the air exhaust. Doing so could cause burns, deform/break the object.

## Turning the power on and off (Continued)

### Notes

- The start-up screen will disappear after a moment. You can dismiss the start-up screen before this by performing any operation. You can also configure the start-up screen not to appear via the **Display setting** menu [p.39](#).
- The first time you use the projector after purchase, after the start-up screen disappears, the start menu is displayed [p.27](#).
- Beep sound can be set not to beep in the **Default setting 1** menu [p.42](#).
- When **[Key lock]** is **[On]**, the operation buttons of the projector do not work [p.43](#).
- When **[Password setting]** is **[On]**, then the start-up screen is displayed after the Password entry screen disappears [p.33](#).

### Turning the power off

#### 1 Press the ON/STANDBY button.

A message appears on the screen, confirming that you wish to shut off the power. This message will disappear after a moment. (This operation is no longer valid after the message disappears.)

#### 2 Press the ON/STANDBY button once again.

When the setting of beep sound is **[On]**, the projector beeps, and the screen turns off, but the internal cooling fan continues to operate. Then, the projector goes into standby mode.

During cooling, the ON/STANDBY indicator flashes. While the indicator is flashing, the power can not be turned back on. At this point of time, it does not matter even if you unplug the power cord.

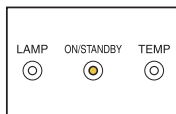

### Note

- The projector consumes about 10W of power in standby. We recommend that you unplug the power cord if you will not be using the projector for an extended period.

### PRECAUTION

- If you turn the power on before cooling is complete, give the lamp time (about 5 minutes) to cool before plugging it back in. If the lamp overheats, it may fail to light.

### LCD Panels

**LCD panels wear out. In order to prolong the lifetime of your LCD panel, take the following precautions.**

- In order to extend the lifetime of the LCD panel, always turn off the power when not in use, and make sure that the lamp is off. Keeping the lamp off is also very effective at saving electricity.
- If the air filter becomes dirty and clogged, the projector's internal temperature will rise, shortening the lifetime of the LCD panel and causing malfunctions. Clean the air filter from time to time [p.52](#), and replace it periodically. Contact the store where you purchased your projector, or your local Service Station for replacement air filters.

## Basic operations

### 1 Turn on the power.

Turn on the power by following the instructions in "Turning the power on" [p.25](#).

### 2 Select the language and the lamp power (When using the first time).

When the projector is used for the first time after purchase, the start menu for language (to display the menus and messages on the screen) and lamp power selection and configuration is displayed in English. (If the screen is out of focus, adjust it according to the step ⑥.)

- ① Use the **▲** or **▼** button to select the desired language and press the **⏻** button. Message for setup confirmation is displayed in a selected language.

Then, the menu for lamp power selection and configuration is displayed. It is automatically set as Standard. To change the setting, follow the step ②.

- ② Use the **▲** or **▼** button to select the lamp power and press the **⏻** button.

The lamp power, if selected, will be toggled without pressing the **⏻** button. The display automatically disappears in a few seconds.

|           |                       |
|-----------|-----------------------|
| English   | English               |
| Français  | French                |
| Deutsch   | German                |
| Italiano  | Italian               |
| Español   | Spanish               |
| Português | Portuguese            |
| Русский   | Russian               |
| Svenska   | Swedish               |
| Türkçe    | Turkish               |
| Polski    | Polish                |
| 日本語       | Japanese              |
| 中文(简体字)   | Chinese (simplified)  |
| 中文(繁體字)   | Chinese (traditional) |
| 한국어       | Korean                |

### Notes

- When the projector is turned on the next time, the start menu does not appear upon startup. However, if **[Reset all]** is executed from the **Default setting 2** menu [p.43](#), the start menu will be displayed the next time when the power is turned on.
- The language can also be set via the **Display setting** menu [p.39](#) and Lamp power via the **Default setting 1** menu [p.42](#).
- This owner's manual assumes that English has been selected.

### 3 Activate the connected device.

Turn on and start the connected device such as a computer.

### 4 Press the INPUT button.

An image of the connected equipment is projected.

Each time you press the **INPUT** button, it switches to the input of the connected equipment that is outputting video signals.

### Notes

- When **[Auto input search]** is set to **[Off]** in the **Default setting 1** menu [p.42](#) (factory setting is **[On]**), the **Input select** menu appears if you press the **INPUT** button.
- If no signal is being output from the connected equipment, pressing the **INPUT** button does not change the input and "There is no other input signal." will appear.

## Basic operation (Continued)

### 5 Projector placement angle adjustments

The placement angle and the height of the projected image can be adjusted by the foot adjuster.

- 1 Lift up the front of the projector to the desired angle, then press the foot adjuster release button.

The foot adjuster extends. Release the button to lock the position.

- 2 To fine adjust the angle, twist the foot adjuster.

- 3 To adjust the horizontal angle, use the right and left tilt adjusters.

- To stow the foot adjuster, hold up the projector while pressing the foot adjuster release button, then slowly lower the projector.

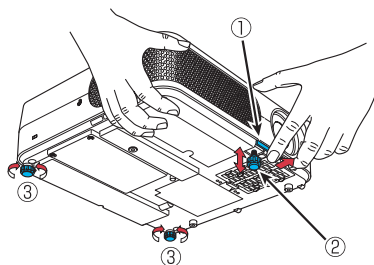

### 6 Adjusting the screen size and focus

- 1 Use the zooming lever to adjust the screen size.
- 2 Use the focusing ring to adjust the focus.

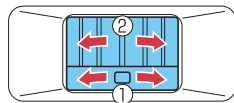

### 7 Adjusting the volume with the ◀ ▶ buttons

The speaker volume can be adjusted when an audio signal is being input.

#### Notes

- Note that lamp characteristics may rarely cause the brightness to fluctuate slightly.
- A lamp is consumable item. If used for extended periods, images will appear dark, and the lamp could burn out. This is characteristic of a lamp, and is not malfunction. (The lifetime of the lamp depends on conditions of use.)
- The LCD panel is made using extremely advanced technology, but there may be black spots (pixels that do not light) or bright spots (pixels that are constantly lit) on the panel. Please note that these are not malfunctions.
- Although this projector supports a wide range of RGB signals [p.57](#), any resolutions not supported by this projector (XGA) will be expanded or shrunk, which will affect image quality slightly. To view high-quality images, it is recommended that the computer's external output should be set to XGA resolution.
- With some models of computer having LCD displays or the like, displaying images simultaneously on the projector and the monitor's display may prevent the images from displaying properly. If this happens, turn off the computer's LCD display. For information on how to turn off the LCD display, see the owner's manual of your computer.
- If no signal is being input from the connected equipment or signal input is stopped while projecting, the "No signal" will appear.
- If a signal not supported by the projector is input, the "Unsupport signal" will appear.
- If an unavailable operation button is pressed, the icon will appear.

## Using handy features

### Using auto setting (Only for input from computer)

This function sets up the projector to the optimum state such as sampling phase, frequency, screen position, and clamp for each type of the input signal by using simple operations.

- Press the remote control's AUTO SET button.

For computer input, the icon will appear during processing. You can set as well by selecting [Auto setting] in the Image adjustment menu [p.37](#).

#### Notes

- The image may not be projected or auto adjustment/setting may not be performed correctly for input signals other than those supported by the projector [p.57](#), [p.58](#).
- If auto setting fails adjustment, adjust manually with [Position] in the Image adjustment menu [p.37](#).

Remote Control



### Correcting the keystone distortion

When the projector placement angle against the screen is changed while projecting the image, the picture will undergo keystone (trapezoidal) distortion.

This projector is capable of correcting this keystone distortion.

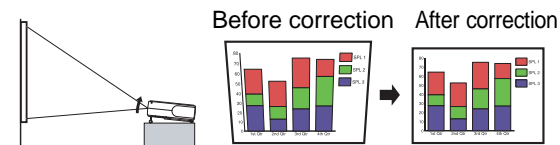

Control panel

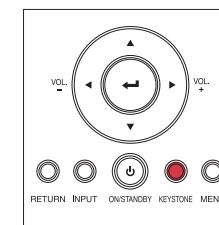

Remote Control

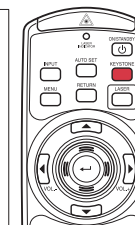

- 1 Press the KEYSTONE button.

The **Keystone** menu appears. By default, [Auto v-keystone] is selected.



| Item                   | Description   |
|------------------------|---|
| <b>Auto v-keystone</b> | Automatically corrects the vertical distortion. Press . |
| <b>V-keystone</b>      | Screen shrinking at bottom   Screen shrinking at top    |

## Using handy features (Continued)

### Adjusting Keystone distortion [Auto]

#### 2 Press the button.

The keystone distortion is automatically corrected. The  icon appears during this correction.

When adjustment is finished, the **Keystone** menu appears again. For fine adjustment, select [**V-keystone**] by the  button and adjust image manually by the  buttons.

### Adjusting Keystone distortion [Manual]

#### 2 Select [**V-keystone**] by the button.

#### 3 Use the buttons for keystone adjustment.

#### Note

- Depending on the amount of keystone adjustment and the content of images, some information may be lost, or the picture quality may suffer.

## Resizing image

The projected image can be resized (zoomed in/out).

#### 1 Press the remote control's **RESIZE** button.

Each time you press the **RESIZE**  button, zoom ratio is up. You can keep pressing.



#### 2 To zoom out, press the remote control's **RESIZE** button.

Each time you press the **RESIZE**  button, zoom ratio is down. You can keep pressing.

(However, the image cannot be smaller than the original size.)



#### 3 To move the area to zoom in, use the buttons.

You can keep pressing.



#### 4 To reset the zoom, press the **RETURN** button.

The image is reset to the original size.

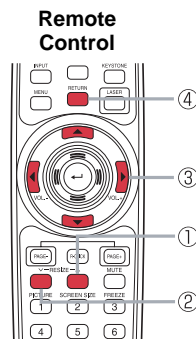

#### Notes

- The  icon appears while resizing.
- Operating a function other than Mute will release resizing.
- As zooming is processed digitally, the image quality is degraded in larger zoom ratio.
- During resizing or moving the zooming area, the image may be distorted.

## Cutting off the picture and sound temporarily (Mute)

When you want to project the images of another projector, overhead projector, etc. temporarily, this projector's images and sound can be turned off.

#### Press the remote control's **MUTE** button.

The picture and sound are cut off. (The Mute function is released when pressing the **MUTE** button again.)

#### Notes

- The  icon will appear while mute is in effect.
- Operating any other functions will also cancel the muting.

Remote Control



## Changing picture mode

The projected image mode can be selected.

#### Press the remote control's **PICTURE** button.

##### 1 The Picture mode menu appears.

1/2/3

##### 2 Select a mode using then press .

Though the  button is not pressed, the picture mode changes as the setting is changed and the display turns off automatically in a few seconds.

#### Note

- [**Picture mode**] of the **Image adjustment** menu has the same function [p.37](#).

Remote Control





## Using handy features (Continued)

### ■ Changing screen size

The screen size for the projected image can be changed.

#### ● Press the remote control's **SCREEN SIZE** button.

Pressing the button switches Full/Thru/Wide in turn.

#### ■ Notes

- Thru display is available for computer-input images.
- [Screen size] of the **Display setting** menu has the same function [p.39](#).
- If you use this function on commercial video software, broadcast or cable-broadcasting except for the purpose of your private viewing and listening, it may infringe the copyright protected by the copyright laws.



### ■ Freezing the image (Freeze)

The image being projected can be frozen. This function is to be used to pause a video during a presentation, etc.

#### ● Press the remote control's **FREEZE** button.

The picture pauses. (The Freeze function is released when pressing the **FREEZE** button again.)

#### ■ Notes

- The  icon will appear while freeze is in effect.
- Other operation will also release the freeze.
- Even if an image is frozen on the projector, the pictures are running on the video or other equipment.
- If you use this function on commercial video software, broadcast or cable-broadcasting except for the purpose of your private viewing and listening, it may infringe the copyright protected by the copyright laws.



### ■ Setting the password

#### ● How to change password

The default password is 0000.

#### ① Select [Password] in the Default setting 2 menu and press the or button.

#### ② Select [Password registration] in the password registration, setting menu, and press the button.

The password entry screen is displayed.

#### ③ Enter the current password (4-digit number).

- Enter a 4-digit number for the password using numeric keys of the remote control.
- Enter [0000] (4 zeros) for the first change.
- The password is not displayed. Instead it appears as [\*\*\*\*].

#### ④ Enter a new password (4-digit number).

#### ⑤ Re-enter the same password for confirmation.

#### ■ Note

- Please do not forget your password. If you forget the password, you can not release the password by yourself. In such a case, please inquire your dealer.

## Using handy features (Continued)

### ● How to set password (from [Off] to [On])

- 1 Select [Password] in the Default setting 2 menu and press the ◀ or ▶ button.
- 2 Select [Password setting] in the password registration, setting menu, and press the ◀ or ▶ button.
- 3 Select [On].
- 4 Select [OK] and press the ⏏ button.  
The password entry screen is displayed.
- 5 Enter the password using numeric keys of the remote control.
- 6 The password setting will be set as [On].

### ● How to operate when password is [On]

- 1 Turn on the power.
- 2 The lamp lights and the password entry screen appears.
- 3 Enter the password using numeric keys of the remote control.

If the entered password is correct, the start-up screen appears and the projector goes into normal operation. If the password is wrong, a message appears to prompt you to re-enter the password, and again the password entry screen is displayed. If you enter a wrong password for more than 5 times, the projector will automatically power off and enter standby mode.

#### ■ Note

- Even if you have forgot the password setting, the password setting can be forcibly set to [On], by detaching the control panel from the projector first when the power is turned back on after the power cord has been unplugged.  
If you can not change the previous password, please input [0000] (4 zeros) using numeric keys of the remote control.

### ● How to set password (from [On] to [Off])

- 1 Select [Password] in the Default setting 2 menu and press the ◀ or ▶ button.  
The password entry screen is displayed.
- 2 Enter the password using numeric keys of the remote control.
- 3 Select [Password setting] in the password registration, setting menu, and press the ◀ or ▶ button.
- 4 Select [OFF].
- 5 Select [OK] and press the ⏏ button.

#### ■ Note

- While the password setting is [On], the password entry screen will be displayed only when the power is turned on next time.

# Using the menus

You can call up on-screen menus, and conduct a number of adjustments and settings using the operation buttons [p.16](#) on the control panel (main unit side) and remote control.

## How to use the menus

The menu shown below is for operation instructions purposes and might differ from the actual display.

1. Press the MENU button Display the **Setting display** menu.
2. Select a Category

Select a category by using . There are following 5 categories:

- Image adjustment menu** [p.37](#)
- Display setting menu** [p.39](#)
- Default setting 1 menu** [p.42](#)
- Default setting 2 menu** [p.43](#)
- Status display menu** [p.44](#)



Displays the current adjustments and settings of selected category. Item shown with gray cannot be adjusted with the current input source.

3. Adjustments & Settings Press or to open the menu.

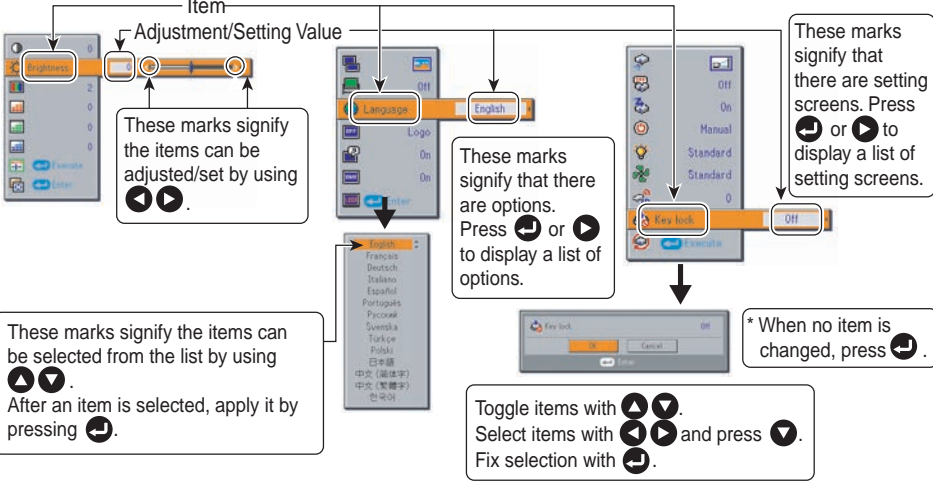

These marks signify that there are options. Press or to display a list of options.

These marks signify that there are setting screens. Press or to display a list of setting screens.

These marks signify the items can be adjusted/set by using .

These marks signify the items can be selected from the list by using . After an item is selected, apply it by pressing .

Toggle items with . Select items with and press . Fix selection with .

\* When no item is changed, press .

The figure shows displays given for operation instructions purposes. As the display may differ depending on the item, use the following pages as a reference.

To return to previous item, press the RETURN button.

4. End Press the MENU button. (The menu disappears about 30 seconds after the last operation.)

## The image adjustment menu

Use this menu to set or adjust image-related items. Items that can be set or adjusted are marked with “Yes”, and those that cannot are marked with “No”. (When an item is masked, it indicates that you cannot select for the current input.)

| Item                               | Description  | Computer | Y/Pb/Pr | Video | S-video | Camera (XC2000) |
|------------------------------------|--|----------|---------|-------|---------|-----------------|
| <b>Contrast</b>                    | Adjust the image contrast.<br>Lower   Higher   | Yes      | Yes     | Yes   | Yes     | Yes             |
| <b>Brightness</b>                  | Adjust the brightness of the image.<br>Darker   Brighter   | Yes      | Yes     | Yes   | Yes     | Yes             |
| <b>Color</b>                       | Adjust the color of the image.<br>Lighter   Deeper   | No       | Yes     | Yes   | Yes     | No              |
| <b>Sharpness</b>                   | Adjust the sharpness of the image.<br>Softer   Sharper   | Yes      | Yes     | Yes   | Yes     | Yes             |
| <b>Noise reduction<sup>1</sup></b> | Set the function to reduce screen noise.<br>On (Enable)   Off (Disable)  | No       | Yes     | Yes   | Yes     | No              |
| <b>Picture mode</b>                | Press . Toggle the picture mode with  . 1/2/3  | Yes      | Yes     | Yes   | Yes     | No              |
| <b>R-level</b>                     | Adjust red of the image color.<br>Less red   More red  | Yes      | Yes     | Yes   | Yes     | Yes             |
| <b>G-level</b>                     | Adjust green of the image color.<br>Less green   More green  | Yes      | Yes     | Yes   | Yes     | Yes             |
| <b>B-level</b>                     | Adjust blue of the image color.<br>Less blue   More blue   | Yes      | Yes     | Yes   | Yes     | Yes             |
| <b>NTSC mode<sup>2</sup></b>       | Set the black level with  .<br>US : NTSC (US) mode<br>JAPAN : NTSC (JAPAN) mode  | No       | No      | Yes   | Yes     | No              |
| <b>Auto setting</b>                | Automatically adjusts items such as the sampling phase depending on the type of input signal.                                | Yes      | No      | No    | No      | No              |
| <b>Position</b>                    | Press  then change mode using   and adjust with  .   | Yes      | No      | No    | No      | No              |
|                                    | <b>Phase</b><br>Adjust to eliminate flicker.   | Yes      | No      | No    | No      | No              |
|                                    | <b>Frequency</b><br>Adjust to eliminate periodic patterns and flickering when many fine vertical lines appear on the screen. | Yes      | No      | No    | No      | No              |
| <b>H-position</b>                  | Adjust the horizontal position of the image.   | Yes      | No      | No    | No      | No              |

## Using the menus (Continued)

| Item ▲ ▼ | Description   | Computer | Y/Pb/Pr | Video | S-video | Camera (XC2000) |
|----------|---|----------|---------|-------|---------|-----------------|
| Position | <b>V-position</b><br>Adjust the vertical position of the image. | Yes      | No      | No    | No      | No              |
|          | <b>Clamp 1</b><br>Adjusts the clamp pulse position.             | Yes      | No      | No    | No      | No              |
|          | <b>Clamp 2</b><br>Adjusts the clamp pulse width.                | Yes      | No      | No    | No      | No              |

\*1: [Noise reduction] may not work depending on signal type.

\*2: [NTSC mode] can be displayed and adjusted only when the video signal is set to [NTSC] or [NTSC4.43]. NTSC mode is set to JAPAN when the language is set to Japanese. It is set to US for other languages.

## The display setting menu

Use this menu to set screen display-related items.

(The items in gray color cannot be set with the current input selection.)

| Item ▲ ▼                               | Description   |
|--|---|
| <b>Screen size</b>                     | <br>(Full): Display with 1024 × 768 dot resolution<br>(Thru): Display with sampling resolution (for computer input only)<br>(Wide): Wide-screen display   |
| <b>Up/down shift</b>                   | Lets the projected image shift vertically when the screen size setting is wide display (within the range of 1024 × 768).  |
| <b>Blackboard mode</b>                 | When projecting on a non-screen surface, select a color in accordance with the projecting surface.<br>Press  and switch with ▲ and ▼. <i>Off/Green/Black/Brown/Blue/Beige</i>   |
| <b>Language</b>                        | Select one of the languages below to use for displaying the menu and messages<br>or : Enter setting mode → [▲▼]: Selection → [Apply:  ]<br><b>English/Français/Deutsch/Italiano/Español/Português/Русский/Svenska/Türkçe/Polski/日本語/中文(简体字)/中文(繁体字)/한국어</b> |
| <b>Background</b>                      | Screen to display when there is no input signal<br>or : Enter setting mode → [▲▼]: Selection → [Apply:  ]<br><b>Logo/Blue/None</b>  |
| <b>Icon</b>                            | Display icons as function guides <span style="float: right;">On  Off</span>   |
| <b>Start-up screen</b>                 | Display start-up screen when power is turned on <span style="float: right;">On  Off</span>  |
| <b>User logo</b>                       | Display a logo customized by the user for the start-up screen or when there is no input signal.<br>or : Enter setting mode → [▲▼]: Selection  |
|  | <b>Logo registration</b> Press  to display the registration menu.   |
|  | <b>Display style</b>  |
|  | <b>Background</b> <b>Black</b> <b>Blue</b> <b>White</b>   |
|  | <b>Logo confirmation</b> Press .  |
| <b>Reset logo</b> <b>Yes</b> <b>No</b> |   |

### Detailed description

#### [Screen size]

- If "Thru" is selected for [Screen size], portions exceeding the native resolution (1024 × 768 pixels) will not appear on the screen. Note that for RGB signals with clock frequency 140MHz or lower, all input pixel signals are sampled. However, if the clock speed is higher than this, the RGB pixel signal is thinned before sampling.

## Using the menu (Continued)

### Note

- If you use the screen size setting function on commercial video software, broadcast or cable-broadcasting programs to display images with the varying aspect ratio except for the purpose of your private viewing and listening, it may infringe the copyright protected by the copyright laws.

### [Up/down shift]

Shifts the projected image vertically when [Screen size] is [Wide].

### [Blackboard mode]

Projects the image in colors more like projecting on a screen.

### Precaution

- The projected image may differ depending on the type, color, and material of the blackboard and wall even if the selected color is the same as the projected screen.

### [Background]

- TOSHIBA is set for [Logo] by factory setting.
- If user's logo has been registered, it is displayed when [Logo] is set for background.

### [Start-up screen]





If user's logo has been registered and this setting is [On], the logo is displayed at start-up.

### [User logo]

Registers a part of the image that is input from computer, as a stationary picture and displays it as a logo at start-up and when no signal is input.

### <Logo registration>

#### How to register user logo



- 1 Select [User logo] in the Display setting menu, and press the  or  button.
- 2 Select <Logo registration> from the displayed menu list and press the  button.
- 3 The registration area is displayed for confirmation. Select [OK] or [Cancel] and press the  button.
  - If the registered picture does not fall within the display area, operate the computer to scroll the screen.
- 4 Select [Yes] to register and press the  button.
- 5 Registration starts.
  - A message is displayed while registration is in process.

### Notes

- You can register a logo from computer input only.
- The area that can be registered is 512 × 384 dots at the center of the screen. To register a company logo, prepare the image within the limit.
- Only one logo can be registered. When a new image is registered, the old one is erased.
- The time needed to register or display the image varies depending on the data size.
- If you use this function on commercial video software, broadcast or cable-broadcasting except for the purpose of your private viewing and listening, it may infringe the copyright protected by the copyright laws.

### <Display style>

Select the size of the registered logo.

- : Displays the registered image in original size at center of the screen.
- : Displays the registered image by enlarging fully in the screen.  
(As processed digitally, the image quality is degraded.)

### <Background>

Sets background color when [Center] is selected for the logo [Display style].

### <Logo confirmation>

You can preview the registered logo.

### <Reset logo>

You can reset the registered logo, display style and background to the factory setting. (The logo set for the start-up screen and background is reset.)

# Using the menus (Continued)

## ■ The default setting menu

This menu shows placement status and other settings.

### Default setting 1 menu

| Item ▲▼                    | Description   |
|----------------------------|---|
| <b>No signal power off</b> | Set the time to wait for the power to be turned off after the last operation is made with no input signal.<br><b>Off</b> (not turned off) ◀▶ <b>30 min.</b>           |
| <b>Auto input search</b>   | Set whether the input with signals is only selected or not.<br><b>On</b> ▶▶ <b>Off</b>  |
| <b>Beep</b>                | Beep when operation is made.<br><b>On</b> ▶▶ <b>Off</b>   |
| <b>Power on</b>            | Sets whether to turn on the power when the <b>ON/STANDBY</b> button is pressed (Manual), or when the power cord is plugged in (Auto).<br><b>Manual</b> ▶▶ <b>Auto</b> |
| <b>Lamp power</b>          | Sets the lamp power.<br><b>Low</b> ▶▶ <b>Standard</b>   |

### ● Detailed description

#### [Auto input search]

[On]: Automatically searches the signals that can be projected, and switches input from the connected device that outputs the video signals each time the **INPUT** button is pressed. The input from the connected device that outputs no video signals is skipped.

[Off]: Displays the **Input select** menu.

Toggle with ▼▲ buttons and press ◀ button. (The input without signals can be selected.)

#### [Power on]

Note that if [Power on] is set to [Auto], then if the power is supplied when restored after a power outage, the projector will come on.

#### [Lamp power]

When [Lamp power] is set to [Low], the screen becomes a little darker, but the cooling fan noise gets quieter.

#### Input select menu

| Input select |            |
|--------------|------------|
| ●            | Computer 1 |
| ○            | Y/Pb/Pr 1  |
| ●            | Computer 2 |
| ○            | Y/Pb/Pr 2  |
| ●            | Video      |
| ○            | S-video    |

●/○ shows whether signal is input or not.

### Default setting 2 menu

| Item ▲▼                | Description   |
|------------------------|---|
| <b>Projection mode</b> | Sets projection mode in accordance with Placement Style. <a href="#">p.22</a><br>(Standard) ▶▶  (Rear) ▶▶  (Ceiling) ▶▶  (Rear ceiling)   |
| <b>Fan mode</b>        | Sets the cooling fan speed. <b>Standard</b> ▶▶ <b>High</b>  |
| <b>Remote control</b>  | When two or more projectors are used and controlled by the remote control respectively, this menu sets the code for the projector and the remote control.<br>[◀ or ▶: Enter setting mode] → [▶▶: Select from 1, 2, 3, 4] → [▶: Confirm] → [▶▶: Select OK to end]<br>Press [Cancel] to return. |
| <b>Key lock</b>        | Lock the control panel buttons.<br>[◀ or ▶: Enter setting mode] → [▶▶: Select On/Off] → [▶: Confirm] → [▶▶: Select OK to end]<br>Press [Cancel] to return.  |
| <b>Reset all</b>       | Press ◀. (The password and user logo are not reset.)<br>Resets all adjustments and settings to their factory settings.<br><b>Yes</b> ▶▶ <b>No</b>   |
| <b>Password</b>        | Password setting <a href="#">p.33</a>   |

### ● Detailed description

#### [Fan mode]

Setting [Fan mode] to [High] increases the cooling fan speed. (The cooling fan noise gets louder.) Set this option to use the projector, for example, at high altitude (over 1,500 meters above sea level).

- Do not set Fan mode to [High] when using the projector at a lower altitude.

#### [Remote control]

Sets a remote control code from 4 types. You can set each code respectively for up to 4 projectors. The factory setting is [1].

To switch codes, set the same code for the projector and the remote control.

A remote control code is applied after the setting is done.

- You cannot operate the remote control if the codes of the projector and the remote control do not match.

#### Remote control code setting for remote control

Remove the battery cover and set the same **remote control code switch** as the projector. [p.16](#) [p.17](#) (Use a screwdriver with thin tip to set.)



## Using the menu (Continued)

### [Key lock]

Protect from operating errors by locking on the control panel buttons of the projector. (The remote control operations are available.)

Control panel operations are locked after the setting is done, and accordingly operation with the control panel buttons is disabled.

- To release the key lock, set the **[Key Lock]** to **[Off]** using remote control. Pressing the **[RETURN]** button on the projector for 10 seconds also sets the **[Key Lock]** to **[Off]**. (When operating the main unit, the 2 indicators of LAMP and TEMP light in orange for 3 seconds, and at the same time the projector beeps.)

## ■ Displaying Information (Status display)

This displays information about the input signal, lamp use time, etc.

“Yes”: displayed, “No”: not displayed

| Item             | Description                                 | Computer | Y/Pb/Pr | Video | S-video | Camera (XC2000) |
|------------------|---|----------|---------|-------|---------|-----------------|
| <b>Projector</b> |   |          |         |       |         |                 |
| Input            | Input source name                           | Yes      | Yes     | Yes   | Yes     | Yes             |
| Mode name        | RGB input mode <sup>[Note 1]</sup>          | Yes      | No      | No    | No      | No              |
| Resolution       | Resolution (in dots)                        | Yes      | No      | No    | No      | No              |
| Frequency        | Sync frequency                              | Yes      | No      | No    | No      | No              |
| Sync             | Sync signal polarity <sup>[Note 2]</sup>    | Yes      | No      | No    | No      | No              |
| Signal format    | Y/Pb/Pr signal format                       | No       | Yes     | No    | No      | No              |
| Video mode       | Color method of video signal                | No       | No      | Yes   | Yes     | No              |
| Lamp time        | Time of lamp use <sup>[Note 3]</sup>        | Yes      | Yes     | Yes   | Yes     | Yes             |
| Lamp reset count | The count for lamp replacement              | Yes      | Yes     | Yes   | Yes     | Yes             |
| Total time       | The total time that this projector is used. | Yes      | Yes     | Yes   | Yes     | Yes             |
| Version          | Firmware version <sup>[Note 4]</sup>        | Yes      | Yes     | Yes   | Yes     | Yes             |

### Notes

- The mode of supported RGB signals [p.57](#) is shown.
- Sync signal polarity shown as P (positive) or N (negative) for [H/V].
- Displays **[Lamp time]** as a measure of when the lamp should be replaced. (Cannot be used as a counter of guaranteed lamp time.) Please replace the lamp after 2000 hours of use if **[Lamp power]** is set to **[Standard]**, or after 3000 hours of use if **[Lamp power]** is set to **[Low]**, consult with a dealer about getting replacement for lamp TLPLW11 (sold separately).
- [Version]** shows the version of the projector's internal control program. This version is referred to for customer service, etc.

### ■ Note

- The displayed information will not be refreshed if the status changes. To refresh the information, dismiss the display, then display it again.

## Using the document camera

Please read this chapter if the model you purchased includes a document camera.

### ■ Preparation of the document camera

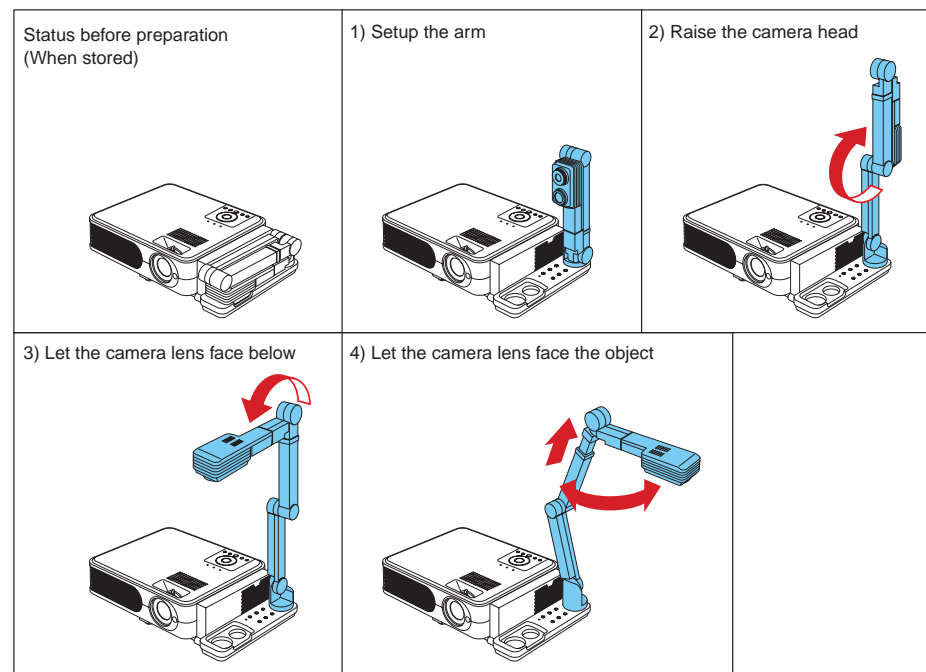

### ■ PRECAUTIONS

- Do not jolt or force the camera head or camera arm. Doing so could cause malfunction.
- The CMOS image sensor mounted on the camera of this projector is produced by precision engineering. Please be informed that missing pixels and bright spots are not considered as problems.

### ■ Note

- It takes about 10 seconds from when the power is turned on until the operation is possible. This is not a problem.

# Using the document camera (Continued)

## Image projection with the document camera

### 1 Press the LED LIGHT button.

The illumination LED lights.

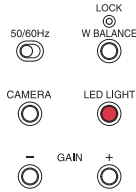

**CAUTION**

- Please do not look into the lighting LED directly. The strong light may cause damage to the eyes or sight.

### 2 Place the document.

Set the document at the side of the projector.

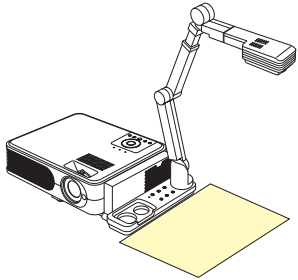

### 3 Press the CAMERA button, and select camera input.

- The input returns to the previous input when the CAMERA button is pressed again.
- Camera input can also be selected by pressing either the remote control or projector's INPUT button.

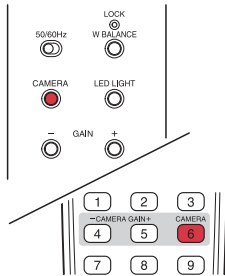

### 4 Rotate the camera head to align the orientation of the document for shooting by checking the screen.

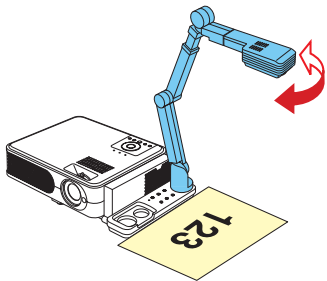

### 5 Move the camera arm up and down to adjust the image size.

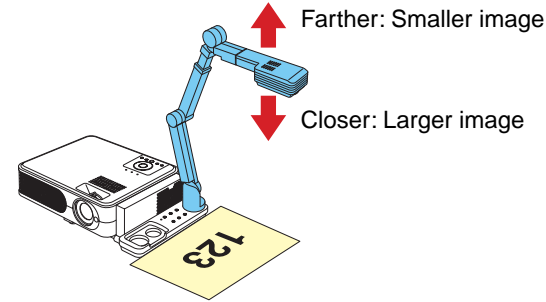

- When projecting the document of A4 size (210 mm x 297 mm), please adjust the height of the camera head to about 43 cm.

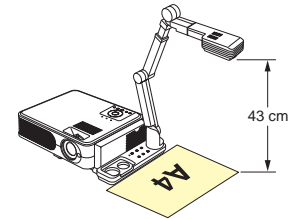

#### Notes

- You can use the RESIZE function of the remote controller to change the size of an image. [p.30](#)
- In the camera input mode, the image may disappear for a moment. This is not a problem.

### 6 Adjust the focus with the focusing ring of the camera head.

Adjust by rotating the focusing ring of the camera head until the projected image becomes clear.

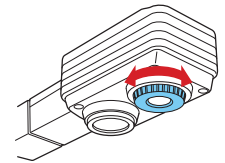

### 7 If the screen is too dark or too bright, use the CAMERA GAIN (+/-) buttons to make it easier to see.

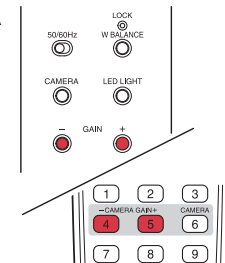

### 8 Fold up the camera using the reverse order from unfolding the document camera.

Fold up with the reverse steps of "Preparation of the document camera".

#### PRECAUTION

- If the room's fluorescent lighting causes the image to flicker, either change the Shutter setting of shutter speed by 50/60Hz switch, or turn off the fluorescent light. Note that changing the Shutter setting may not eliminate the flicker, depending on the state of lighting, document or image adjustment.

#### Note

- There is no audio output when the camera input is selected.

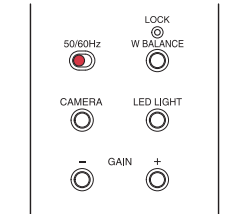



## Using the document camera (Continued)

### ■ Locking the white balance

Although the projector's camera is constantly adjusting the color balance of the images it photographs, the color balance may be disrupted, depending on the color layout of the document. If this happens, the white balance can be locked using the procedures below.

#### ① Lay down a piece of white paper, and adjust so it fills the screen.

Adjust the camera head and arm so that the white paper fills the screen completely.

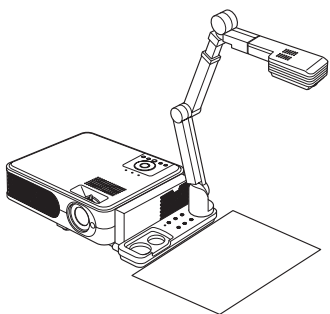

#### ② Press W.BALANCE button and lock the white balance.

The **LOCK** indicator which shows the white balance has been locked lights. If you want to return to the auto adjustment, please press **W.BALANCE** once again. The **LOCK** indicator will be off.

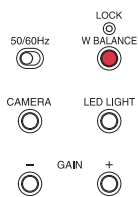

### ■ Notes

- If the white balance is set to [**Lock**], once power is turned off or the arm is pushed down, the setting goes back to [**Auto**].
- The color of the room lighting may prevent the white balance from being adjusted to the optimum level. In this situation, if you want to use a certain tinting, adjust the [**R-level**], [**G-level**] and [**B-level**] on the Image adjustment menu.

## About lamp

The product's light source is a mercury lamp that lights at increased internal pressure. Be sure to fully understand the following characteristics of the lamp and handle it with extreme care.

- The lamp may burst with a loud noise due to impact or deterioration, or fail to light at the expiration of its life.
- How long it takes before the lamp bursts or the life expires may vary greatly by lamp. Some may burst shortly after first use.
- Burst is likely to happen if the lamp is used after the replacement period has elapsed.
- When the lamp bursts, the broken pieces of glass may get inside the product or be released outside from the openings for ventilation.
- When the lamp bursts, a slight amount of mercury gas enclosed in the lamp along with glass dust may be released from the openings for ventilation.

### ■ Immediately replace the lamp when a sign appears on the screen.

- When the replacement time approaches, a message will appear on the screen.
- The risk of burst will increase if the lamp is continuously used without being replaced.
- Frequently check the used hours and prepare spares when the replacement time approaches. (Refer to "Status display". [p.44](#))

### ■ When the lamp is broken

- If glass components, including a lamp and a lens, should break, handle the broken pieces with care to avoid injury and contact your dealer for repair service.
- In the event of lamp burst, unplug the product from the wall outlet, leave and completely ventilate the room. Then, thoroughly clean the area around the projector and discard any edible items placed in that area.
- When the lamp bursts, consult a doctor if glass dust or mercury gas gets into your eyes or you breathe it.

# Lamp replacement

A lamp is consumable supplies. If used for extended periods, images will appear dark, and the lamp could burn out. This is characteristic of a lamp, and is not malfunction. (The lifetime of the lamp depends on condition of use.) If this happens, replace it with a new one.

## ⚠ WARNING

- If the projector is mounted on the ceiling, it is recommended to use your Toshiba dealership when the lamp has to be exchanged. Uncovering the lamp while the projector is mounted on a ceiling may lead to a danger of damage from falling pieces of glass if the lamp is broken. Besides, working at high elevations can also be hazardous. Do not attempt to replace the lamp by yourself.
- When replacement is required, be sure to use TLPLW11 (sold separately).

## ⚠ CAUTION

- If you have been using the projector, the lamp will be very hot, and may cause burn injuries. Wait for the lamp to cool (for longer than 1 hour) before replacing it.
- If the lamp should break, please handle with care to avoid injury due to broken pieces (p.49) and contact your dealer for repair service.

### 1 Unplug power cord.

### 2 Wait until lamp is sufficiently cooled.

Wait for at least 1 hour.

### 3 Remove the lamp cover.

Loosen the two screws, raise the lamp cover with your fingers as shown to remove the lamp cover. Use care to avoid any damage to nails and/or tip of your finger(s). If you have any difficulty in removal, you can use a screwdriver or any other smaller tool for your convenience.

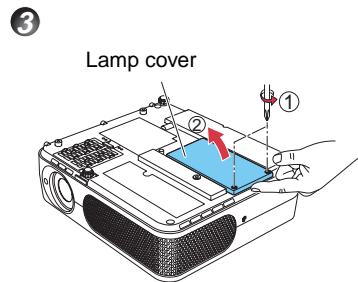

### 4 Pull out the lamp.

Loosen the three lamp locking screws, pull up the handle, and remove the lamp.

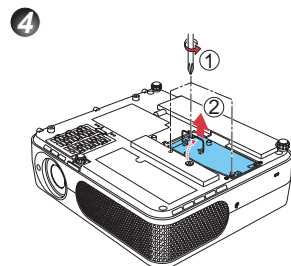

### 5 Mount the new lamp.

Align the orientation, press down the new lamp until the bottom is reached, and lock in place using the three lamp locking screws.

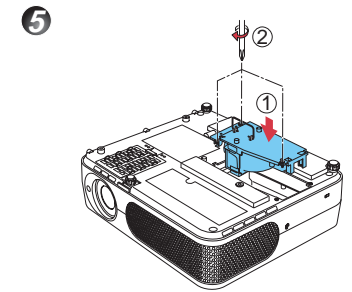

### 6 Replace the lamp cover.

Align the cover, and press it in, then tighten the screws loosened in step 3 until the lamp cover is no longer loose.



### 7 Reset the lamp time.

See the lamp's manual for instructions on resetting the lamp time.

## ■ Notes and Precautions

- The [Lamp time] item in the **Status display** menu indicates the time of lamp use (as a rough guide) p.44
- Please replace the lamp after 2000 hours of use with [Lamp power] in the **Default setting 1** menu set to [Standard], and 3000 hours of use with [Lamp power] in the **Default setting 1** menu set to [Low]. p.42
- There are cases that the lamp can not work before the above mentioned period expires or before the replacement message is displayed.
- Attach the lamp cover correctly so that it is not loose. If it is not attached correctly, the projector may fail to be powered on or the lamp may fail to come on.
- Always replace the lamp with a new one.
- The lamp is made out of glass. Do not touch the glass surface with your bare hands, bang it, or scratch it. (Dirt, jolts, scratches and the like could break the lamp.)

## ● About lamp replacement messages

- The lamp replacement message of this projector displays an appropriate period according to the use period for [Standard] / [Low] of the [Lamp power] respectively.
- When the replacement time approaches, the message of "The lamp life is ending. Please change the lamp." and the icon  are displayed every time the power is turned on. This display disappears when you press the  button.

## ■ Used Lamps

This projector's lamps contain trace amounts of environmentally harmful inorganic mercury. Be careful not to break used lamps, and dispose of them in accordance with local regulations.

## Air filter cleaning

The air filter prevents dust and debris from getting inside the projector. Never run the projector with the filter removed. It is recommended that the air filter is cleaned regularly.

- The message “Check the air filter for dirt.” is displayed every 100 hours. (If the usage time exceeds 100 hours, this message is displayed for about 30 seconds when the image is displayed for the first time after power is turned on. This display will be dismissed with any operation.)
- Check out the filter and any debris is found, use the following procedure for cleaning.

### ⚠ WARNING

- Request cleaning and maintenance of a ceiling-mounted unit from your projector dealership.

#### 1 Unplug power cord.

#### 2 Remove the air filter.

Pull out the air filter by taking the catch shown in the figure.

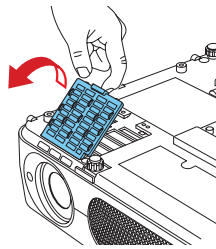

#### 3 Clean the filter.

Carefully remove the dust and dirt from the air filter with a vacuum cleaner or the like.

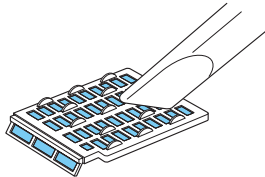

#### 4 Replace the air filter.

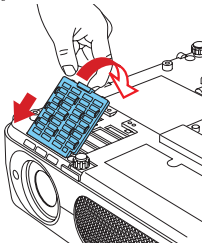

### ■ Notes

- Allowing dirt and dust to build up in the air filter will worsen the air circulation inside the projector, causing the internal temperature to rise, causing the projector to stop working or malfunction.
- Insert the air filter all the way in. Leaving gaps will allow dust and dirt to get inside the projector again.
- If you wash the air filter with water, make sure to dry it completely before replacing it.
- If the air filter is torn, consult with your dealer about replacing it with a new one. Continuing to use a ripped filter will allow dust and dirt to get inside the projector.

## Lens and main unit cleaning

### ⚠ WARNING

- Request cleaning and maintenance of a ceiling-mounted unit from your projector dealership. Attempting to clean/replace the lamp at a high site by yourself may cause you to fall down, thus resulting in injury.

#### ■ Lens cleaning

- Clean the lens with a commercially available blower and/or lens cleaner.
- The lens is easily scratched, so do not rub it with hard objects, or strike it.

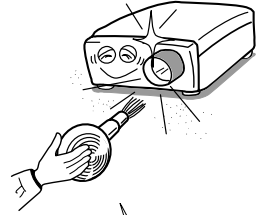





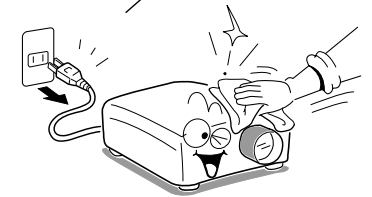







#### ■ Main unit cleaning

- Clean the main unit after unplugging the power cord.
- Wipe dirt off the main unit gently with a soft cloth.
- Do not wipe the main unit with a damp cloth. Doing so may allow water to get inside, resulting in an electric shock or failure.
- Do not use benzene, thinner and the like as they may deform or discolor the unit or damage the paint surface.
- When using a chemically treated cloth, follow the precautions included with the cloth.



# Trouble indications

The indicator lights to inform you of internal abnormalities.

|   |   |
|---|---|
| <p>LAMP ONSTANDBY TEMP<br/> <br/>           (Off)</p>  | <p><b>No power</b><br/>           ⇒ Problem with projector<br/>           • Unplug the power cord, and contact your dealer.</p>   |
| <p>LAMP ONSTANDBY TEMP<br/> <br/>           (Red flashing) Or<br/> <br/>           (Red lit) (Red lit)</p>                          | <p><b>Lamp went out during use, or won't come on</b><br/>           ⇒ Lamp temperature is high so that it is difficult to turn on, the lifetime of the lamp has ended or the projector is malfunctioning.<br/>           • Unplug the power cord and wait for a short while, then turn the power back on.<br/>           • If a lamp burns out, replace it with a new one.<br/>           * The abnormal display will not disappear until the power cord is unplugged.<br/>           You can not turn on the power during abnormal display.</p>  |
| <p>LAMP ONSTANDBY TEMP<br/> <br/>           (Red lit) (Red flashing)</p>   | <p><b>Power went out during use</b><br/>           ⇒ Internal overheating, or the outside temperature is too high.<br/>           • Place the projector so that the air intake and exhaust are not blocked.<br/>           • Unplug the power cord and wait for a short while, then turn the power back on.<br/>           * The  icon will appear before the power goes out.<br/>           * The abnormal display will not disappear until the power cord is unplugged.<br/>           You can not turn on the power during abnormal display.</p>  |
| <p>LAMP ONSTANDBY TEMP<br/> <br/>           (Red lit) (Green flashing)</p>   | <p><b>Power went out during use</b><br/>           ⇒ Problem with internal cooling fan.<br/>           • Unplug the power cord, and contact your dealer.<br/>           * The  icon will appear before the power goes out.<br/>           * The abnormal display will not disappear until the power cord is unplugged.<br/>           You can not turn on the power during abnormal display.</p>   |
| <p>LAMP ONSTANDBY TEMP<br/> <br/>           (Orange flashing) (Red lit)</p>  | <p><b>Power went out during use, or power won't come on</b><br/>           ⇒ The lamp cover is not properly attached.<br/>           • Unplug the power cord, and reattach the lamp cover. <a href="#">p.51</a><br/>           * The abnormal display will not disappear until the power cord is unplugged.<br/>           You can not turn on the power during abnormal display.</p>   |
| <p>LAMP ONSTANDBY TEMP<br/> <br/>           (Red lit) (Orange lit)<br/>           Or<br/> <br/>           (Orange flashing)</p> | <p><b>Power went out during use</b><br/>           ⇒ Problem inside the projector.<br/>           • Unplug the power cord and wait for a short while, then turn the power back on.<br/>           • If the above action will not clear the problem, unplug the power cord, and contact your dealer.<br/>           * The  or  icon will appear before the power goes out.<br/>           * The abnormal display will not disappear until the power cord is unplugged.<br/>           You can not turn on the power during abnormal display.</p> |

# Before calling service personnel

If you think something is wrong, check the followings before contacting customer service. Please see "Trouble indications" [p.54](#) as well.

| If This Happens                                     | Check  |
|---|--|
| <b>No power</b>                                     | <ul style="list-style-type: none"> <li>Is the power cord plugged in? Is it connected to the projector?</li> <li>Is the lamp cover attached properly? <a href="#">p.51</a></li> </ul>   |
| <b>Power goes out during use</b>                    | <ul style="list-style-type: none"> <li>Is the ambient temperature high? <a href="#">p.54</a></li> <li>Is the air intake or air exhaust blocked? <a href="#">p.54</a></li> </ul>  |
| <b>No picture</b>                                   | <ul style="list-style-type: none"> <li>Is the projector turned on? (When [Auto input search] is [Off]) <a href="#">p.27</a></li> <li>Is the mute function on? <a href="#">p.31</a></li> <li>Is the brightness setting minimized? <a href="#">p.37</a></li> <li>Are the connections set up correctly? <a href="#">p.23</a></li> <li>Are all the connected devices functioning properly?</li> </ul>  |
| <b>No audio</b>                                     | <ul style="list-style-type: none"> <li>Is the mute function on? <a href="#">p.31</a></li> <li>Is the volume setting minimized? <a href="#">p.28</a></li> <li>Are the connections set up correctly? <a href="#">p.23</a></li> <li>Are all the connected devices functioning properly?</li> </ul>  |
| <b>Picture not displayed correctly</b>              | <ul style="list-style-type: none"> <li>Is the input signal supported by the projector? <a href="#">p.57</a>, <a href="#">p.58</a></li> <li>Is there something generating an abnormal video signal, for instance the video tape?</li> </ul>   |
| <b>Picture blurred Part of picture out of focus</b> | <ul style="list-style-type: none"> <li>Is the lens dirty? <a href="#">p.53</a></li> <li>Is the lens focus adjusted optimally? <a href="#">p.28</a></li> <li>Is the projection distance within the projector's supported range? <a href="#">p.22</a></li> <li>Is the projector's screen placement angle tilted too far? <a href="#">p.22</a></li> <li>Are the sharpness or sampling phase adjustments off? <a href="#">p.37</a></li> </ul>  |
| <b>Image is dark</b>                                | <ul style="list-style-type: none"> <li>Are the brightness or contrast adjustments off? <a href="#">p.37</a></li> <li>Is the lamp nearing the end of its service life? <a href="#">p.44</a></li> </ul>  |
| <b>Colors too light Bad shading</b>                 | <ul style="list-style-type: none"> <li>Are the color, R-level, G-level, or B-level adjustments off? <a href="#">p.37</a></li> <li>Is the screen dirty?</li> <li>Is the blackboard mode set properly? <a href="#">p.39</a></li> <li>Is the lamp nearing the end of its service life? <a href="#">p.44</a></li> </ul>  |
| <b>Control panel key doesn't work</b>               | <ul style="list-style-type: none"> <li>Is the key lock function on? <a href="#">p.43</a>, <a href="#">p.44</a></li> <li>Has the control panel been installed properly? <a href="#">p.15</a></li> </ul>   |
| <b>Remote control doesn't work</b>                  | <ul style="list-style-type: none"> <li>Is the remote control ON/OFF switch set off? <a href="#">p.20</a></li> <li>Is the remote control code identical with the projector's code? <a href="#">p.43</a></li> <li>Are the remote control's batteries drained?</li> <li>Are the batteries inserted into the remote control correctly? <a href="#">p.20</a></li> <li>Is the remote control being used within the effective range? <a href="#">p.20</a></li> <li>Are there any obstructions between the remote control and projector?</li> <li>Are there any fluorescent or other bright lights shining at the projector's infrared remote sensor?</li> </ul> |

# Specifications

## ■ List of general specifications

| Item  | Specification   |  |
|---|---|--|
| Consumption Power                                   | TLP-X2000: 280 W<br>TLP-XC2000: 280 W   |  |
| Weight  | TLP-X2000: 2.8 kg<br>TLP-XC2000: 4.0 kg   |  |
| External Dimensions<br>(including protruding parts) | TLP-X2000: 288 × 92 × 247 mm (W × H × D)<br>TLP-XC2000: 370.5 × 92 × 249 mm (W × H × D) |  |
| Cabinet material                                    | PC resin and PC+ABS resin   |  |
| Conditions for usage environment                    | Temp: 5°C to 35°C; relative humidity: 30% to 70%  |  |
| LCD Panel   | Display method  | 3-panel transmission                                     |
|   | Panel size  | 0.6 type   |
|   | Drive system  | TFT active matrix  |
|   | Picture elements  | 786,432 pixels (1024H × 768V)                            |
| Lens  | Zoom lens F=1.6-1.88 f=18.6-22.3 mm   |  |
| Lamp  | High-pressure mercury lamp (180 W)  |  |
| Connection terminal                                 | Projection screen size  | 33-300 inches  |
|   | Projection distance   | 1.19-9.13 m  |
|   | Speaker   | 1W (Mono)  |
|   | COMPUTER 1<br>IN terminal   | Mini D sub 15 pin RGB / Y/Pb/Pr (dual use)               |
|   | COMPUTER 2<br>IN terminal   | Mini D sub 15 pin RGB / Y/Pb/Pr / MONITOR OUT (dual use) |
|   | S-VIDEO terminal  | Mini DIN 4 pin   |
|   | AUDIO (L/R) terminal  | RCA Pin Jack × 2   |
|   | VIDEO terminal  | RCA Pin Jack   |
|   | AUDIO IN terminal   | 3.5mm dia. stereo mini-jack                              |
|   | AUDIO OUT terminal  | 3.5mm dia. stereo mini-jack                              |
| CONTROL terminal                                    | Mini DIN 8 pin (RS-232C)  |  |

## ■ Document camera specifications (Models equipped with document camera)

| Item                 | Specification                                   |
|----------------------|---|
| Cameralens           | F=3.0, f=9.6 mm                                 |
| Focus adjustment     | Manual  |
| Zoom adjustment      | None (Adjust with the distance from the object) |
| Image Pick-Up Device | 3 million pixel 1/2" color CMOS Sensor          |
| Pixels               | QXGA (horizontal 2048 × vertical 1536)          |
| Illumination         | High brightness LED LED illumination            |

### ■ Notes

- This model complies with the above specifications.
- Designs and specifications are subject to change without notice.
- This model may not be compatible with features and/or specifications that may be added in the future.

## ■ List of supported signals (RGB signals)

This projector supports the following RGB signals. Note, however, that depending on the computer model, the screen may show flicker or streaking. Please adjust the projector if this happens.

| Resolution  | Mode       | Refresh rate (Hz) | H-frequency (kHz) | Clock (MHz) |
|-------------|------------|-------------------|-------------------|-------------|
| 720 x 400   | 720x400_85 | 85.039            | 37.927            | 35.500      |
| 640 x 480   | VGA_60     | 59.940            | 31.469            | 25.175      |
|             | VGA_72     | 72.809            | 37.861            | 31.500      |
|             | VGA_75     | 75.000            | 37.500            | 31.500      |
|             | VGA_85     | 85.008            | 43.269            | 36.000      |
| 800 x 600   | SVGA_56    | 56.250            | 35.156            | 36.000      |
|             | SVGA_60    | 60.317            | 37.879            | 40.000      |
|             | SVGA_72    | 72.188            | 48.077            | 50.000      |
|             | SVGA_75    | 75.000            | 46.875            | 49.500      |
|             | SVGA_85    | 85.061            | 53.674            | 56.250      |
| 832 x 624   | MAC16"     | 74.550            | 49.725            | 57.283      |
| 1024 x 768  | XGA_60     | 60.004            | 48.363            | 65.000      |
|             | XGA_70     | 70.069            | 56.476            | 75.000      |
|             | XGA_75     | 75.029            | 60.023            | 78.750      |
|             | XGA_85     | 84.997            | 68.667            | 94.500      |
|             | MAC19"     | 74.700            | 60.134            | 79.857      |
| 1152 x 864  | SXGA1_75   | 75.000            | 67.500            | 108.000     |
| 1280 x 960  | QuadVGA_60 | 60.000            | 60.000            | 108.000     |
|             | QuadVGA_85 | 85.002            | 85.938            | 148.500     |
| 1280 x 1024 | SXGA3_60   | 60.020            | 63.981            | 108.000     |
|             | SXGA3_75   | 75.025            | 79.976            | 135.000     |
|             | SXGA3_85   | 85.024            | 91.146            | 157.500     |
| 1400 x 1050 | SXGA+      | 59.978            | 65.317            | 121.750     |
| 1600 x 1200 | UXGA_60    | 60.000            | 75.000            | 162.000     |
|             | UXGA_65    | 65.000            | 81.250            | 175.500     |
|             | UXGA_70    | 70.000            | 87.500            | 189.000     |
|             | UXGA_75    | 75.000            | 93.750            | 202.500     |
|             | UXGA_85    | 85.000            | 106.250           | 229.500     |

### ■ Note

- Signals whose resolution exceeds the native resolution (1024 × 768 pixels) will be compressed. For this reason, some information may be lost, or image quality may be affected.

## Specifications (Continued)

### ■ List of supported signals (Y/P<sub>B</sub>/P<sub>R</sub> signals)

| Signal format     | fh(kHz) | fv(Hz) |
|-------------------|---------|--------|
| 480i(525i)@60Hz   | 15.73   | 59.94  |
| 480p(525p)@60Hz   | 31.47   | 59.94  |
| 576i(625i)@50Hz   | 15.63   | 50.00  |
| 576p(625p)@50Hz   | 31.25   | 50.00  |
| 720p(750p)@60Hz   | 45.00   | 60.00  |
| 720p(750p)@50Hz   | 37.50   | 50.00  |
| 1080i(1125i)@60Hz | 33.75   | 60.00  |
| 1080i(1125i)@50Hz | 28.13   | 50.00  |

### ■ List of supported signals (Video, S-Video signals)

| Video mode | fh(kHz) | fv(Hz) | fsc(MHz)     |
|------------|---------|--------|--------------|
| NTSC       | 15.73   | 60     | 3.58         |
| PAL        | 15.63   | 50     | 4.43         |
| SECAM      | 15.63   | 50     | 4.25 or 4.41 |
| PAL-M      | 15.73   | 60     | 3.58         |
| PAL-N      | 15.63   | 50     | 3.58         |
| PAL-60     | 15.73   | 60     | 4.43         |
| NTSC4.43   | 15.73   | 60     | 4.43         |

### ■ Pin assignment of COMPUTER 1 IN, COMPUTER 2 IN & MONITOR OUT terminals

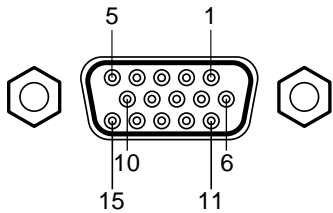

Mini D sub 15 Pin connector

#### Input Signal

- RGB input
  - RGB signals: 0.7V (p-p) 75 Ω
  - Horizontal sync signal: TTL level (Pos/neg polarity)
  - Vertical sync signal: TTL level (Pos/neg polarity)
- Y/P<sub>B</sub>/P<sub>R</sub> input
  - Y signal: 1.0V (p-p) 75 Ω
  - P<sub>B</sub>/P<sub>R</sub> signals: 0.7V (p-p) 75 Ω

| Pin No. | Pin description        |   |
|---------|------------------------|---|
|         | During RGB input       | During Y/P <sub>B</sub> /P <sub>R</sub> input |
| 1       | Video signal (R)       | Color difference signal (P <sub>R</sub> )     |
| 2       | Video signal (G)       | Luminance signal (Y)                          |
| 3       | Video signal (B)       | Color difference signal (P <sub>B</sub> )     |
| 4       | GND                    | *   |
| 5       | GND                    | *   |
| 6       | GND (R)                | GND (P <sub>R</sub> )                         |
| 7       | GND (G)                | GND (Y)                                       |
| 8       | GND (B)                | GND (P <sub>B</sub> )                         |
| 9       | N.C                    | *   |
| 10      | GND                    | *   |
| 11      | GND                    | *   |
| 12      | N.C                    | *   |
| 13      | Horizontal sync signal | *   |
| 14      | Vertical sync signal   | *   |
| 15      | N.C                    | *   |

\* Do not connect anything.

### ■ CONTROL terminal

#### ● Pin assignment

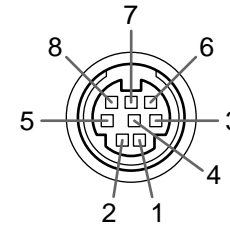

Mini DIN 8 pin connector

| Pin No. | Signal Name | Description     |
|---------|-------------|-----------------|
| 1       | RXD         | Receiving data  |
| 2       | CTS         | Consent to send |
| 3       | DSR         | Data set ready  |
| 4       | GND         | Signal ground   |
| 5       | RTS         | Request to send |
| 6       | N.C         | No connection   |
| 7       | TXD         | Sending data    |
| 8       | GND         | Signal ground   |

#### ● Interface format

- 1 Communication method RS-232C, 9600bps, No Parity, Data Length: 8 bits; Stop Bit Length: 1 bit
- 2 Communication format 

|           |                 |           |
|-----------|-----------------|-----------|
| STX (02h) | Command (3Byte) | ETX (03h) |
|-----------|-----------------|-----------|

  
Only 1 command valid per communication.
- 3 Data format For input commands, only ASCII-compliant all-uppercase alphanumeric characters supported.
- 4 Replies
 

|                |           |           |      |                    |
|----------------|-----------|-----------|------|--------------------|
| Acknowledge    | ACK (06h) | CR (0Dh)  | Data | ... Normally ended |
|                | ACK (06h) | ESC (1Bh) |      | ... Aborted        |
| No acknowledge | NAK (15h) |           |      |                    |

If commands are to be sent consecutively, wait for the response from the projector before sending the next command.

#### ● Main Commands

| Item                     | Command    |
|--------------------------|------------|
| Power on                 | <b>PON</b> |
| Power off                | <b>POF</b> |
| Icon display on          | <b>MO0</b> |
| Icon display off         | <b>MO1</b> |
| Auto setting (RGB input) | <b>PAT</b> |
| Status display on        | <b>DON</b> |
| Status display off       | <b>DOF</b> |

#### ■ Note

- Contact your dealer for control cable and other commands.

### ■ Separately sold product

Replacement Lamp Model TLPLW11

**TOSHIBA CORPORATION**