

MANUFACTURER'S LIMITED TWO YEAR **WARRANTY**

LEGACY SOUND CORP. warrants this unit to be free from defective material or workmanship and will repair or replace this unit or any part thereof if it proves defective in normal use or service within two (2) years from the date of original purchase.

Our obligation under this warranty is limited to repairing or replacing, at our discretion, the defective instrument or any part thereof when it is returned, transportation prepaid to the Legacy Service Center at the address below. This warranty will be considered void if the unit has been tampered with, improperly serviced, subjected to abuse or misuse or if installed in a commercial vehicle. This warranty does not cover accidental damage. When returning this unit for service, please include \$15.00 for return postage and handling. Send your unit to:

**IMPORTANT:** Pack carefully in original carton if possible. We are not responsible for damage incurred in returning items for repair. A letter stating your exact street address, daytime phone number, and the problem you are experiencing should be included. You must also enclose a copy of the original receipt as proof of date of purchase.

LEGACY SERVICE CENTER  
1600 63rd Street  
Brooklyn, NY 11204

**FOR YOUR PROTECTION**  
Completely and immediately mail the Product Registration Card so that we may contact you directly in the event a safety notification is issued in accordance with the 1972 Consumer Product Safety Act, or for other reasons Legacy may deem necessary.



**TECHNICAL SUPPORT HOTLINE**  
Our technical department will gladly answer any questions you may have about our products. They cannot, however tell you the status of a repair, or handle other customer service situations.  
**1-800-934-2277**  
Monday through Thursday, 9AM to 5PM  
Friday 9AM to 2PM Eastern.

**LEGACY®**  
WWW.legacycaraudio.com

**LEGACY®**

**American LEGACY Series 2**



- LA-478
- LA-578
- LA-678
- LA-778
- LA-878
- LA-978
- LA-1478
- LA-1878
- LA-2078
- LA-2278
- LA-2478

**HIGH SPEED  
CAR AMPLIFIER  
USER'S MANUAL**

## Congratulations

on your purchase of a new

# Legacy American Series 2 amplifier !

Legacy amps are some of the most advanced car amplification products available. These quality audio products are designed and engineered to afford you years of uncompromised musical service. Legacy has utilized the latest electronic technologies in order to deliver a superb listening experience.

This innovative system has been designed utilizing a 12 V DC Negative Ground power supply. The Legacy American Series 2 amps incorporate two to eight MOSFETS in the different models.

This design produces enough available voltage to supply the main amplifier sections, and still have a huge amount of reserve voltage for peak "high demand" situations.

The Legacy line has been designed to ensure adequate headroom for even the most demanding peaks and dynamic ranges found on today's CD's and recordings. Used properly, these amplifiers will provide you with years of listening pleasure.

## USER MANUAL table of contents

- 1~2 SPECIFICATIONS
- 3 LA-478/578/778/978/1478/1878/2078/2278  
FEATURES & CONTROLS
- 4 LA-678/878 FEATURES & CONTROLS
- 5 LA-2478 FEATURES & CONTROLS
- 6 ELECTRICAL WIRING, INSTALLATION & SETUP
- 7 2 CH STEREO INPUT CONNECTIONS
- 8 4 CH STEREO INPUT CONNECTIONS
- 9 BRIDGED INPUT CONNECTIONS
- 11 BASIC STEREO SPEAKER CONNECTIONS
- 12 MONO-BRIDGED SPEAKER CONNECTIONS
- 13 MONO BLOCK INPUT & SPEAKER CONNECTIONS
- 14 TROUBLESHOOTING

## Legacy American Amplifier Features

LA-478/578/678/778/878/978

1478/1878/2078/2278 also feature:

- Soft turn on/off circuit
- Variable gain control
- Remote turn on/off
- Hi/low level inputs
- Power on LED indicator
- LED protection indicator
- Fully adjustable electronic crossover network
- Remote control Bass boost ( 0 - +18dB @ 60Hz )
- 2 ohm stereo stable
- Bridgeable into 4 ohms
- MOSFET PWM power supplies

Specifications	LA-478 2CH amplifier	LA-578 2CH amplifier	LA-678 4CH amplifier	LA-778 2CH amplifier	LA-878 4CH amplifier
OUTPUT POWER RMS @ 4 OHMS RMS @ 2 OHMS MAX OUTPUT BRIDGE MODE	2 X 40W 2 X 60W 2 X 300W 1 X 600W	2 X 50W 2 X 75W 2 X 400W 1 X 800W	4 X 35W 4 X 55W 4 X 250W 2 X 250W+500W OR 2 X 500W	2 X 75W 2 X 125W 2 X 500W 1 X 1000W	4 X 50W 4 X 60W 4 X 400W 2 X 400W+800W OR 2 X 800W
FREQUENCY RESPONSE	10Hz-30 kHz				
INPUT IMPEDANCE LOW LEVEL INPUTS HIGH LEVEL INPUTS	10 k-Ohms 100 Ohms				
INPUT SENSITIVITY LOW LEVEL INPUTS HIGH LEVEL INPUTS	250 mV 2.5V				
POWER SUPPLY VOLTAGE	14.4 VDC/NEG GD (10.5-16V)				
MATCHING SPEAKER IMPEDANCE STEREO MODE BRIDGED MODE	2-4 OHMS 4-8 OHMS	2-4 OHMS 4-8 OHMS	2-4 OHMS 4-8 OHMS	2-4 OHMS 4-8 OHMS	2-4 OHMS 4-8 OHMS
MAXIMUM CURRENT DRAW	15 A	15 A	20 A	20 A	40 A
DIMENSIONS, W x H x L, inches (mm)	12.2 X 2 X 8.25 (309 X 53 X 209)	12.2 X 2 X 9.25 (309 X 53 X 235)	12.2 X 2 X 12 (309 X 53 X 305)	12.2 X 2 X 12 (309 X 53 X 305)	12.2 X 2 X 15 (309 X 53 X 381)
NET WEIGHT, LBS (KG)	5.2(2.37)	5.9(2.67)	7.7(3.5)	7.6(3.46)	9.1(4.4)

# Legacy American Amplifier Features

LA-2478 also feature:

- Mono Block Subwoofer Amplifier
- 2 Ohm Stable
- MOSFET Power Supply
- Gold Plated RCA Inputs for Line Input & Bypass Output.
- Gold Plated Terminals for Speaker Output and Power Input.
- Thermal, Overload and Short Protection
- Variable Sub-sonic Filter (15Hz~40Hz, 24dB/Octave)
- Variable Low-pass Filter (20Hz~250Hz, 24dB/Octave)
- Phase Control 0-180 degree
- Remote Bass Control
- Input Impedance : 10K Ohms
- Soft Turn On/Off
- Advanced Protection Circuitry
- S/N Ratio:>90dB

## Specifications

	LA-978 2CH amplifier	LA-1478 2CH amplifier	LA-1878 2CH amplifier	LA-2078 2CH amplifier	LA-2278 2CH amplifier	LA-2478 Mono channel amplifier
<b>OUTPUT POWER</b>						
RMS @ 4 OHMS	2 X 100W	2 X 125W	2 X 150W	2 X 200W	2 X 300W	200W mono
RMS @ 2 OHMS	2 X 150W	2 X 200W	2 X 225W	2 X 300W	2 X 450W	335W mono
MAX OUTPUT	2 X 600W	2 X 800W	2 X 1000W	2 X 1200W	2 X 2000W	2000W mono
BRIDGE MODE	1 X 1200W	1 X 1600W	1 X 2000W	1 X 2400W	1 X 4000W	
<b>FREQUENCY RESPONSE</b>	10Hz-30 kHz					20-250Hz(±3dB)
<b>INPUT IMPEDANCE</b>						
LOW LEVEL INPUTS	10 k-Ohms					10 k-Ohms
HIGH LEVEL INPUTS	100 Ohms					100 Ohms
<b>INPUT SENSITIVITY</b>						
LOW LEVEL INPUTS	250 mV					250 mV
HIGH LEVEL INPUTS	2.5V					4V
<b>POWER SUPPLY VOLTAGE</b>	14.4 VDC/NEG GD (10.5-16V)					14.4 VDC/NEG GD (10.5-16V)
<b>MATCHING SPEAKER IMPEDANCE</b>						
STEREO MODE	2-4 OHMS	2-4 OHMS	2-4 OHMS	2-4 OHMS	2-4 OHMS	2 OHM
BRIDGED MODE	4-8 OHMS	4-8 OHMS	4-8 OHMS	4-8 OHMS	4-8 OHMS	STABLE
<b>MAXIMUM CURRENT DRAW</b>	30 A	30 A	40 A	50 A	70 A	40 A
<b>DIMENSIONS, W x H x L, inches (mm)</b>	12.2 X 2 X 13.5 (309 X 53 X 343)	12.2 X 2 X 15 (309 X 53 X 381)	12.2 X 2 X 17 (309 X 53 X 432)	12.2 X 2 X 19 (309 X 53 X 482)	12.2 X 2 X 21 (309 X 53 X 532)	12.2 X 2 X 12 (309 X 53 X 305)
<b>NET WEIGHT, LBS (KG)</b>	8.2(3.73)	8.8 (4.0)	10.1 (4.62)	11.4 (5.2)	12.8 (5.8)	7.3 (3.34)

specs  
Features and Specifications

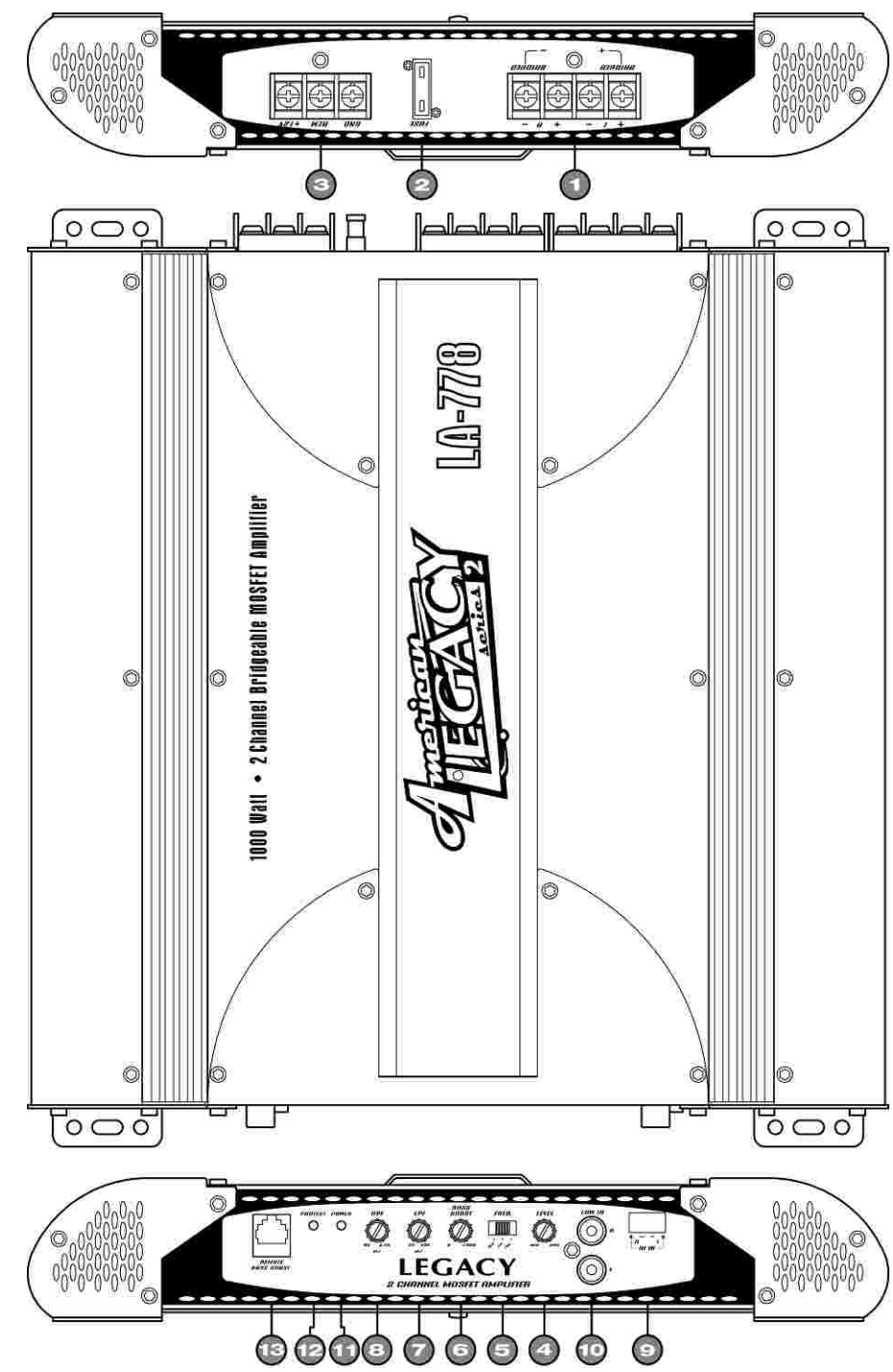

LA-478/578/778/978/1478/1878/2078/2278  
Features and Controls

- Speaker Terminals**  
These terminals are 14K Gold plated for high conductivity and minimum impedance loss. The terminals face upwards for easy wiring in tight situations.
- Fuse**  
Protects the amplifier as well as the automobile electrical system from short circuit conditions.
- Power Supply Terminals**
- Input Level Control**  
Use this control to match the output of the head unit to the amplifier. If distortion is present, reduce the setting of this control.
- Crossover Mode Switch**  
In a full range system, set this to FULL. If the amp is being used to power a crossover system, set to either HPF or LPF as needed.
- Bass Boost Control**  
Allows you to increase the bass signal level sent to the speakers
- Low Pass Control**  
Permits you to adjust the crossover frequency from 35 Hz to 400 Hz to suit the subwoofers
- High Pass Control**  
Permits you to adjust the crossover frequency from 80 Hz to 2.5 kHz to suit the tweeters
- High Level Input (Low Impedance)**  
Use these if your car stereo does not have RCA output jacks; connect the speaker output from the head unit to these inputs
- Low Level Input (High Impedance)**  
This unit is provided with gold-plated RCA input jacks. Using RCA-RCA type patch cords, connect these inputs to the RCA outputs from your head unit.
- Power LED Indicator**  
This LED is illuminated when the REMOTE ON system is turned on.
- Protection LED Indicator**  
The protection circuitry in the amp will disable it if it senses an input overload, speaker short circuit, or thermal overload conditions. Should this occur, the PROTECT LED will be illuminated. At that time, it is important that you check to determine what has caused the protection circuitry to become activated.  
  
If the amp shut off because of a thermal overload, allow it to cool down before attempting to restart.  
  
If the shutdown occurred because of an input overload, or speaker short circuit, be sure to correct these conditions before attempting to restart the amp.  
  
To reset the amp, turn the REMOTE power off and on again.
- Remote Bass Boost**  
Plug in the Remote Bass Boost Control wire in here.

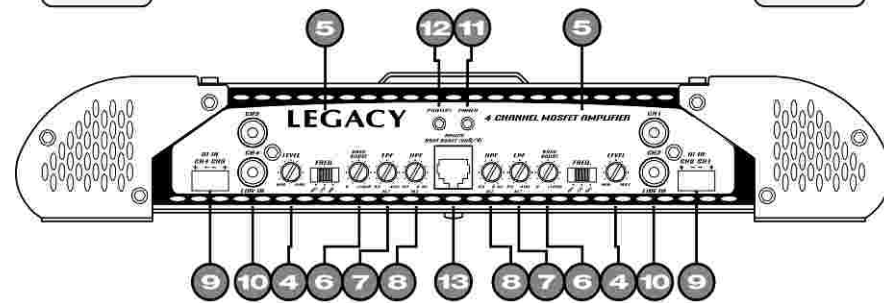
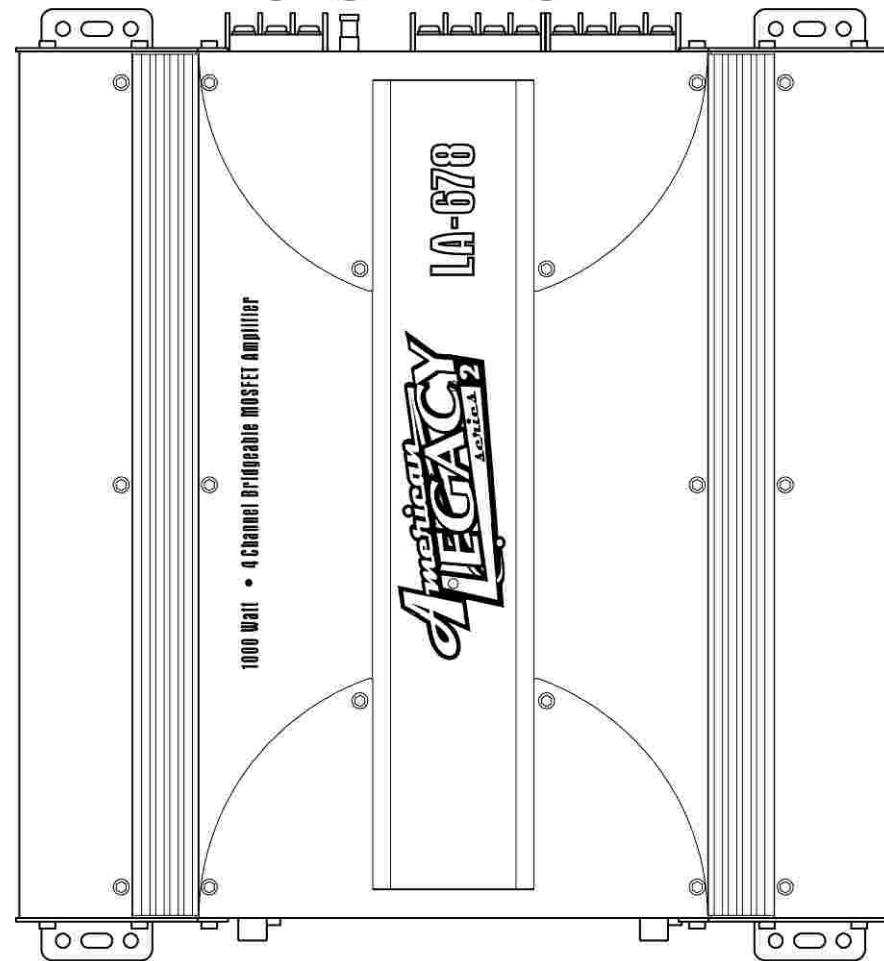
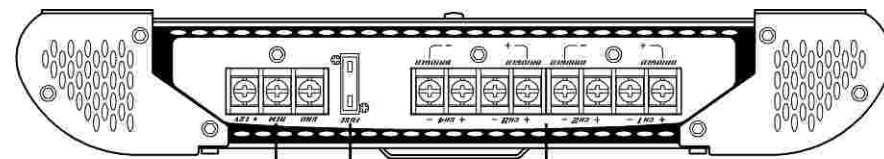

LA-678/878 Features and Controls

- 1 **Speaker Terminals**  
These terminals are 14K Gold plated for high conductivity and minimum impedance loss. The terminals face upwards for easy wiring in tight situations.
- 2 **Fuse**  
Protects the amplifier as well as the automobile electrical system from short circuit conditions.
- 3 **Power Supply Terminals**
- 4 **Input Level Control**  
Use this control to match the output of the head unit to the amplifier. If distortion is present, reduce the setting of this control.
- 5 **Crossover Mode Switch**  
In a full range system, set this to FULL. If the amp is being used to power a crossover system, set to either HPF or LPF as needed.
- 6 **Bass Boost Control**  
Allows you to increase the bass signal level sent to the speakers
- 7 **Low Pass Control**  
Permits you to adjust the crossover frequency from 35 Hz to 400 Hz to suit the subwoofers
- 8 **High Pass Control**  
Permits you to adjust the crossover frequency from 80 Hz to 2.5 kHz to suit the tweeters
- 9 **High Level Input (Low Impedance)**  
Use these if your car stereo does not have RCA output jacks; connect the speaker output from the head unit to these inputs
- 10 **Low Level Input (High Impedance)**  
This unit is provided with gold-plated RCA input jacks. Using RCA-RCA type patch cords, connect these inputs to the RCA outputs from your head unit.
- 11 **Power LED Indicator**  
This LED is illuminated when the REMOTE ON system is turned on.
- 12 **Protection LED Indicator**  
The protection circuitry in the amp will disable it if it senses an input overload, speaker short circuit, or thermal overload conditions. Should this occur, the PROTECT LED will be illuminated. At that time, it is important that you check to determine what has caused the protection circuitry to become activated.  
  
If the amp shut off because of a thermal overload, allow it to cool down before attempting to restart.  
  
If the shutdown occurred because of an input overload, or speaker short circuit, be sure to correct these conditions before attempting to restart the amp.  
  
To reset the amp, turn the REMOTE power off and on again.
- 13 **Remote Bass Boost**  
Plug in the Remote Bass Boost Control wire in here.

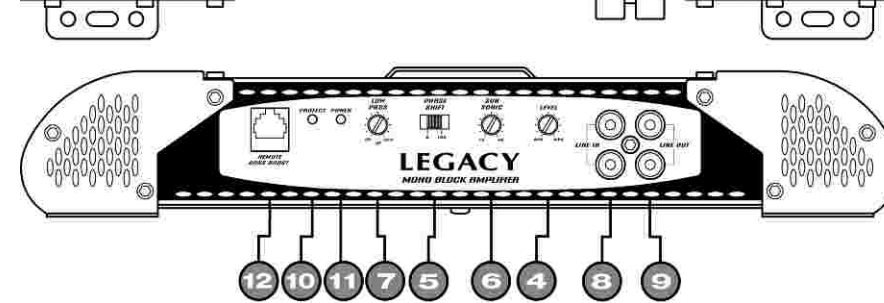
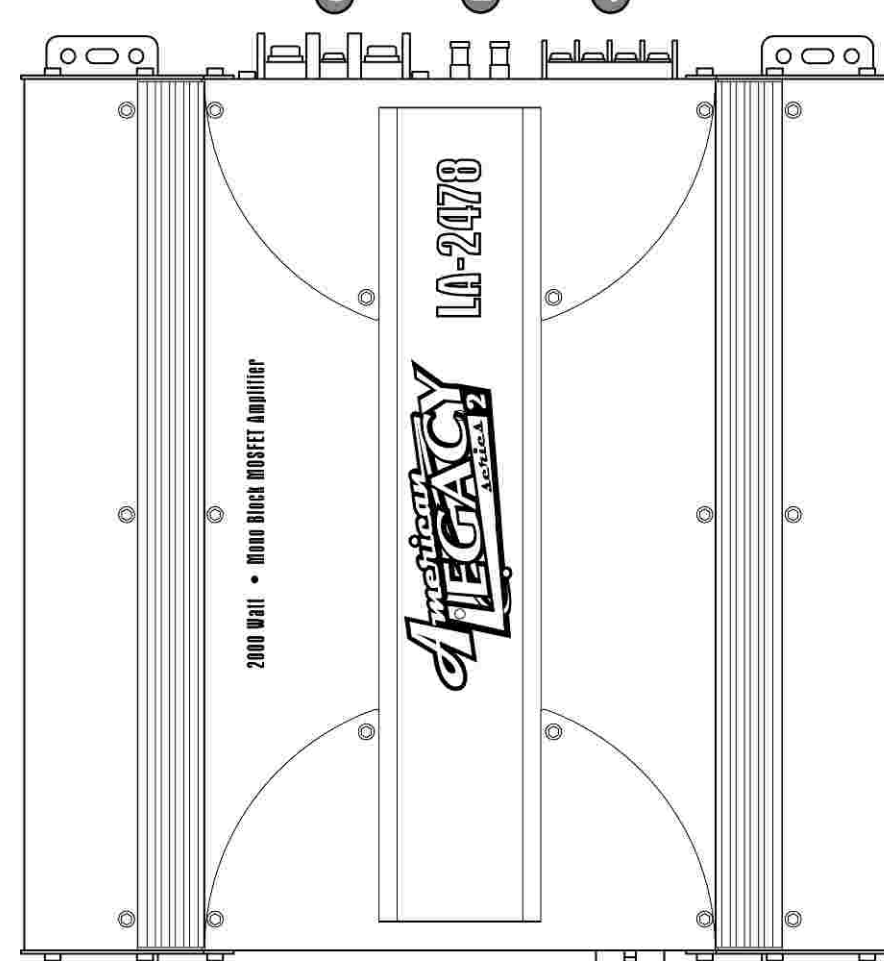
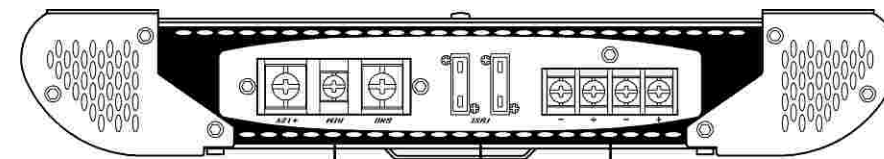

LA-2478 Features and Controls

- 1 **Speaker Terminals**  
These terminals are 14K Gold plated for high conductivity and minimum impedance loss. The terminals face upwards for easy wiring in tight situations.
- 2 **Fuse**  
Protects the amplifier as well as the automobile electrical system from short circuit conditions.
- 3 **Power Supply Terminals**
- 4 **Input Level Control**  
Use this control to match the output of the head unit to the amplifier. If distortion is present, reduce the setting of this control.
- 5 **Phase Shift Switch**  
Allows you to change the phase of your subwoofer from 0 degree to 180 degrees to help compensate from timing difference between drivers.
- 6 **High Pass Subsonic Filter**  
Adjustable from 15Hz to 40Hz with a slope of 24dB per octave. This allows for the attenuation of frequencies that are mostly inaudible and cause unnecessary strain on the amplifier.
- 7 **Crossover Low Pass Filter**  
Adjustable from 20Hz to 250Hz with a slope of 24dB per octave. This allows for the adjustment of the upper point of the frequency bandwidth and the respective subwoofer.
- 8 **Low Level Input (High Impedance)**  
This unit is provided with gold-plated RCA input jacks. Using RCA-RCA type patch cords, connect these inputs to the RCA outputs from your head unit.
- 9 **Low Level Output (High Impedance)**  
This unit is provided with gold-plated RCA Output jacks. Using RCA-RCA type patch cords, connect these Outputs to the RCA Inputs for your anyther amplifier.
- 10 **Protection LED Indicator**  
The protection circuitry in the amp will disable it if it senses an input overload, speaker short circuit, or thermal overload conditions. Should this occur, the PROTECT LED will be illuminated. At that time, it is important that you check to determine what has caused the protection circuitry to become activated.  
  
If the amp shut off because of a thermal overload, allow it to cool down before attempting to restart.  
  
If the shutdown occurred because of an input overload, or speaker short circuit, be sure to correct these conditions before attempting to restart the amp.  
  
To reset the amp, turn the REMOTE power off and on again.
- 11 **Power LED Indicator**  
This LED is illuminated when the REMOTE ON system is turned on.
- 12 **Remote Bass Boost**  
Plug in the Remote Bass Boost Control wire in here.

### Making Power Connections

1. Connect the +12V terminal directly to the car battery (+) terminal.
2. Connect the GROUND terminal directly to the car battery (-) terminal OR to a good clean, paint-free chassis ground point.
3. To ensure a good ground, and to prevent "motor-boating" noise in the system, make an additional connection from the car battery (-) terminal to the chassis of the stereo unit, using 12 gauge minimum wire.
4. Connect the REMOTE terminal to an external switch for positive 12V turn-on. This may be connected to the head unit power antenna lead.

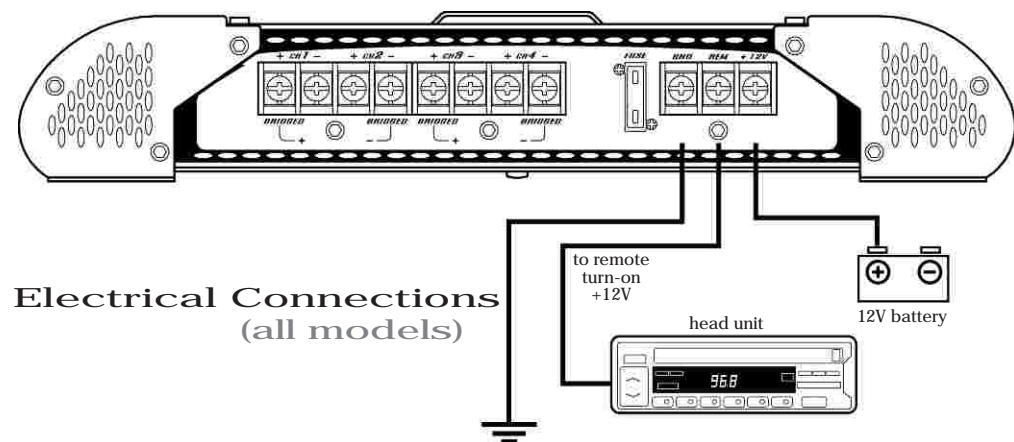

### Installation Precautions

This amplifier comes complete with all mounting hardware required. Please remember that this is a high-power unit, which generates considerable electrical energy and heat. Therefore, be sure to install the unit in a place with sufficient airflow, a minimum of dust, and no moisture. Allow enough space around the cooling fins to permit reasonable airflow and cooling.

- Before you drill or cut any holes, investigate your car's layout very carefully. Take care when you work near the gas tank, fuel lines, hydraulic line and electrical wiring.
- Do not operate the amplifier when it is unmounted. Attach all audio system components securely within the automobile to prevent damage, especially in an accident.
- Do not mount this amplifier so that the wire connections are unprotected or in a pinched condition, or likely to be damaged by nearby objects. Be sure to select a location inside your vehicle which has adequate ventilation.
- Before making or breaking power connections in your system, disconnect the vehicle battery. Confirm that your head unit or other equipment is turned off while connecting the input jacks and speaker terminals.
- If you need to replace the power fuse, only replace it with a fuse identical to that supplied with the system. Using a fuse of a different type or rating may result in damage to your system which isn't covered by the manufacturer's warranty.

### Setting Up and Turning On Your New Amplifier

After all electrical connections have been made, and physical installation is complete, turn on your stereo and listen for the amplifier to turn on. If there are any unusual noises from the speakers, turn the stereo off and recheck ALL wiring.

Assuming the amplifier turn on normally, you may have to adjust the LEVEL control(s) to match the output levels from your head unit. Follow these steps:

1. Set the volume control on your head unit to about the 2/3 position.
2. Adjust the amplifier LEVEL control(s) to an average listening position.
3. Turn the head unit volume all the way down, and listen for background noise.
4. Start your vehicle, and again, listen for background noise.
5. By fine tuning the LEVEL control(s), you can reduce background and engine noise, if present.

These adjustments should only be made once. After that, use the head unit volume control to adjust the system volume, not the LEVEL control(s).

CAUTION: Never turn the LEVEL control(s) up any higher than you need to get clear sound at 2/3 volume on the head unit.

## Electrical Wiring and Installation

### Low Level Stereo Input Connection

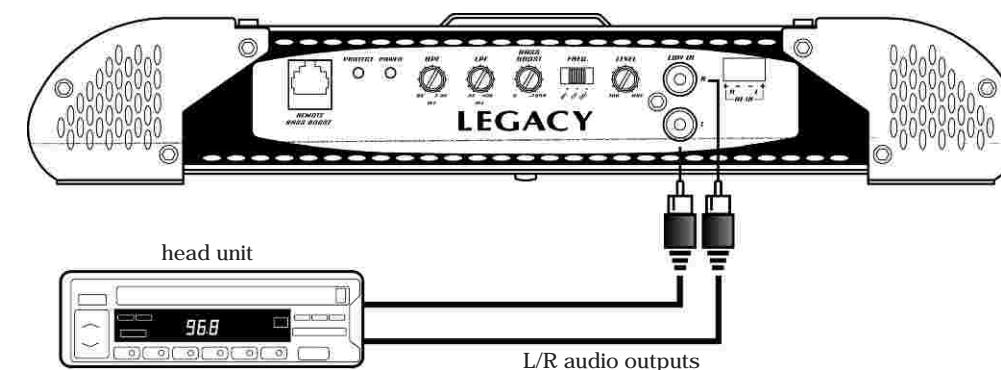

### High Level Stereo Input Connection

PLEASE NOTE! If using high level inputs, do not use the low level RCA inputs at the same time!

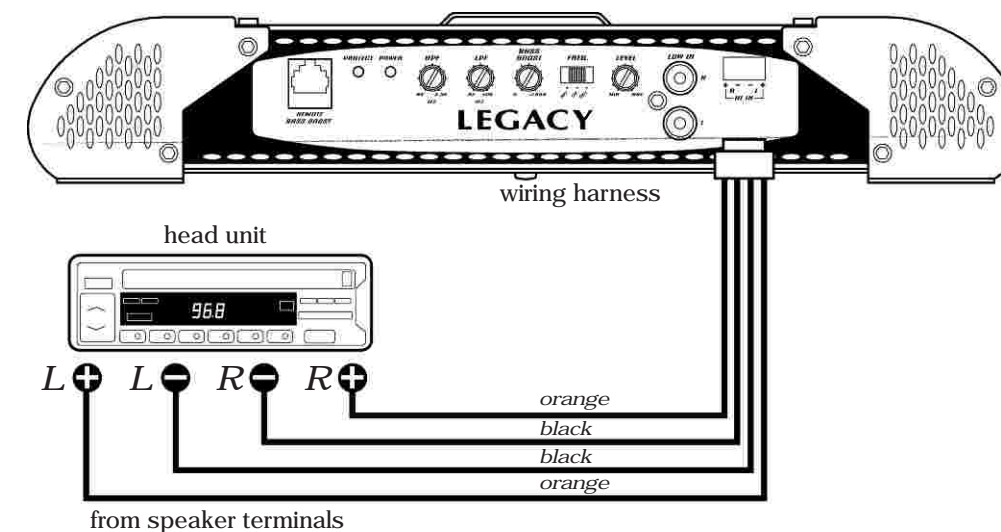

LA-478  
LA-578  
LA-778  
LA-978  
LA-1478  
LA-1878  
LA-2078  
LA-2278  
2CH AMPS

LA-678  
LA-878  
4CH AMPS

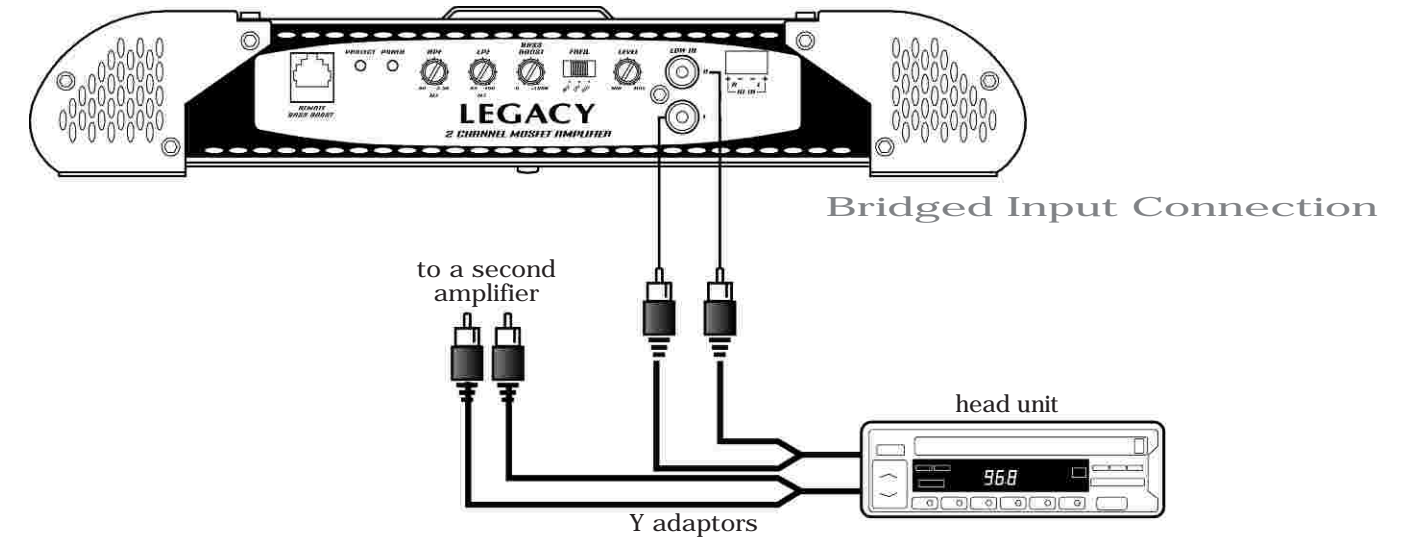
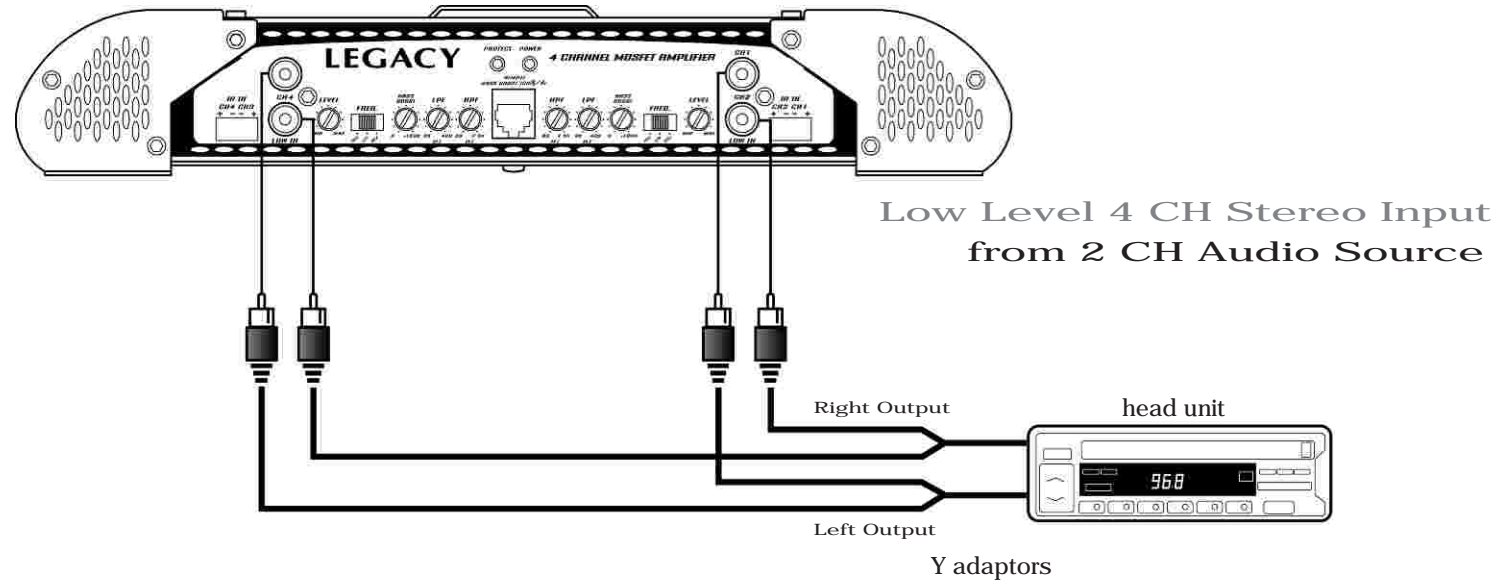

LA-478  
LA-578  
LA-778  
LA-978  
LA-1478  
LA-1878  
LA-2078  
LA-2278  
2CH AMPS

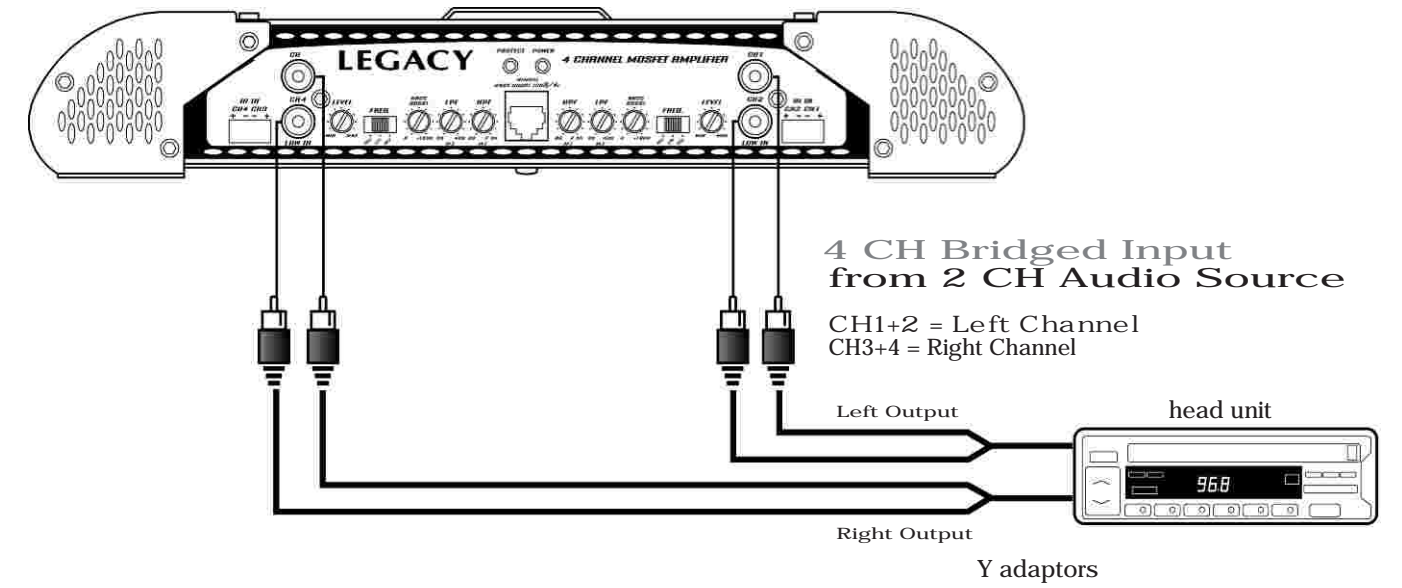
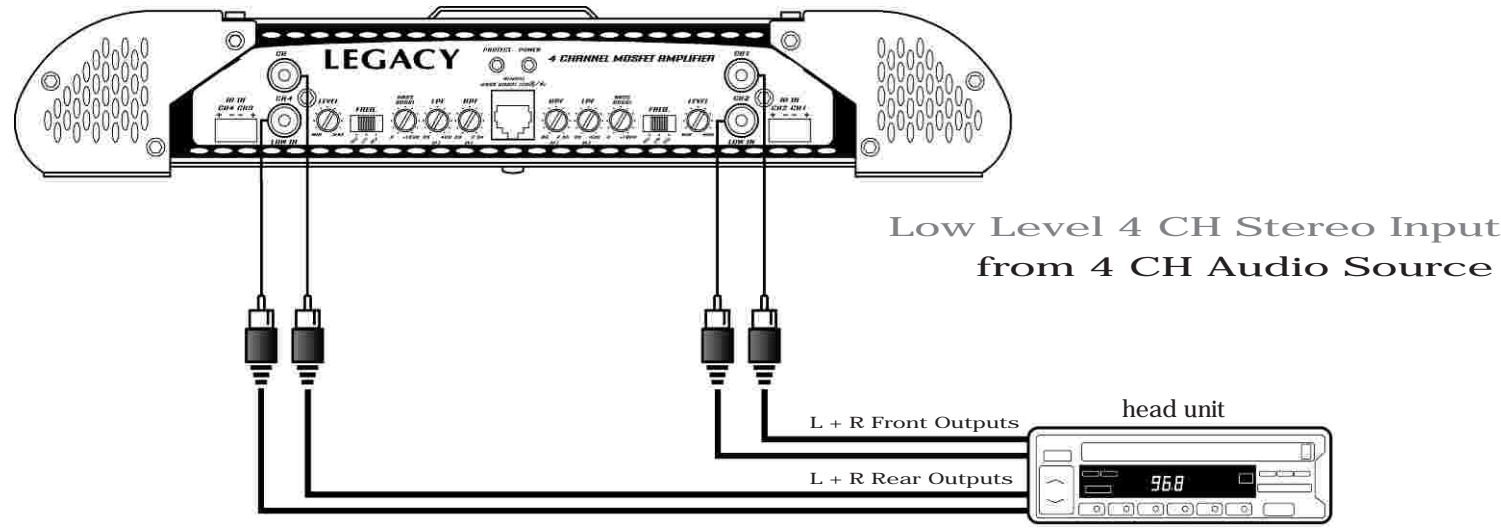

LA-678  
LA-878  
4CH AMPS

LA-678  
LA-878  
4CH AMPS

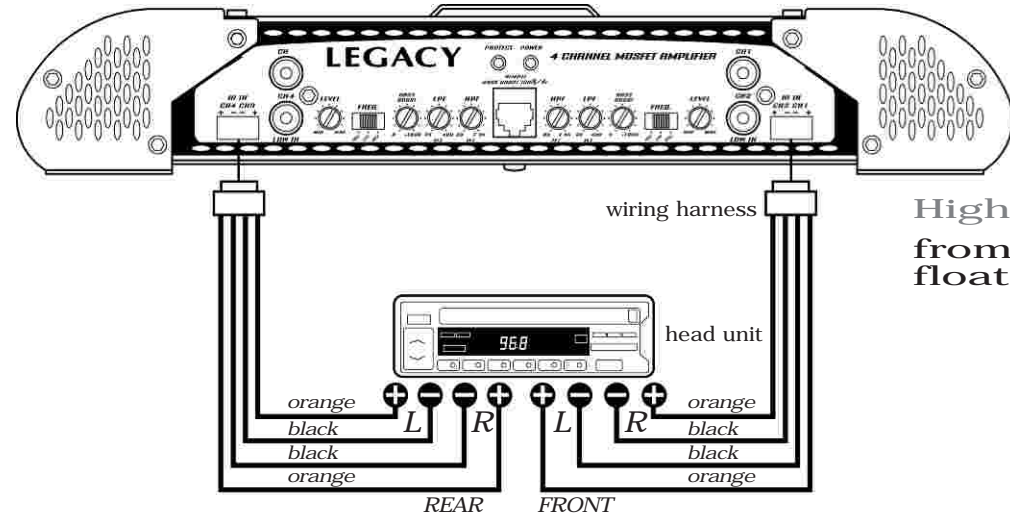

High Level 4 CH Stereo Input  
from 4CH Audio Source  
floating ground connection

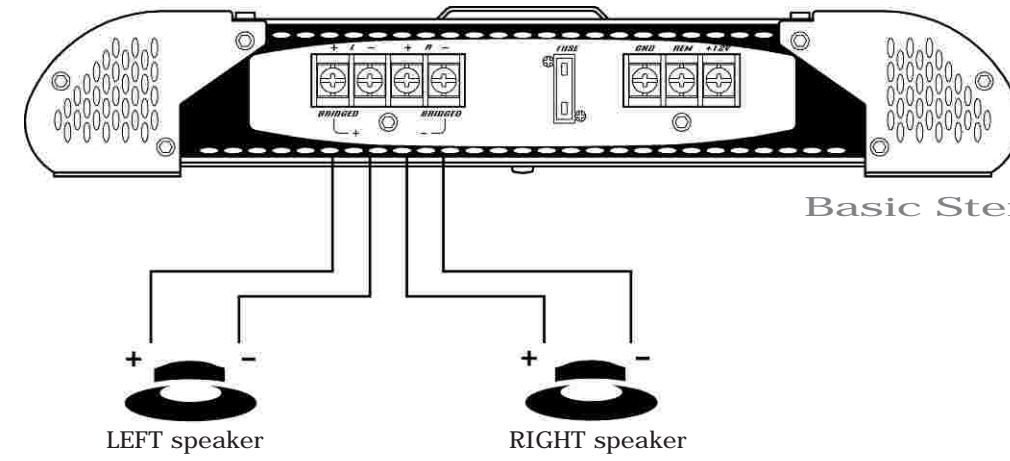

Basic Stereo Output

LA-478  
LA-578  
LA-778  
LA-978  
LA-1478  
LA-1878  
LA-2078  
LA-2278  
2CH AMPS

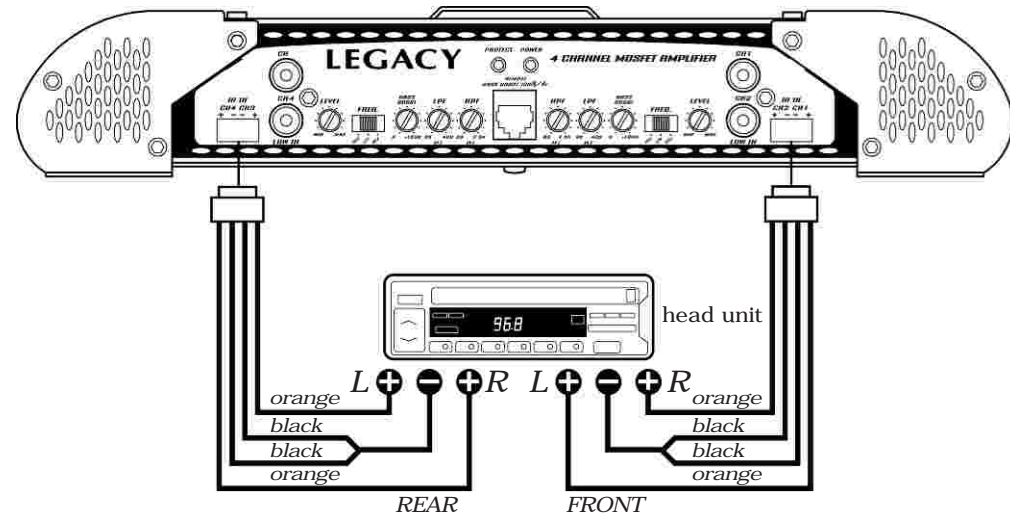

Level 4 CH Stereo Input  
4CH Audio Source  
non ground connection

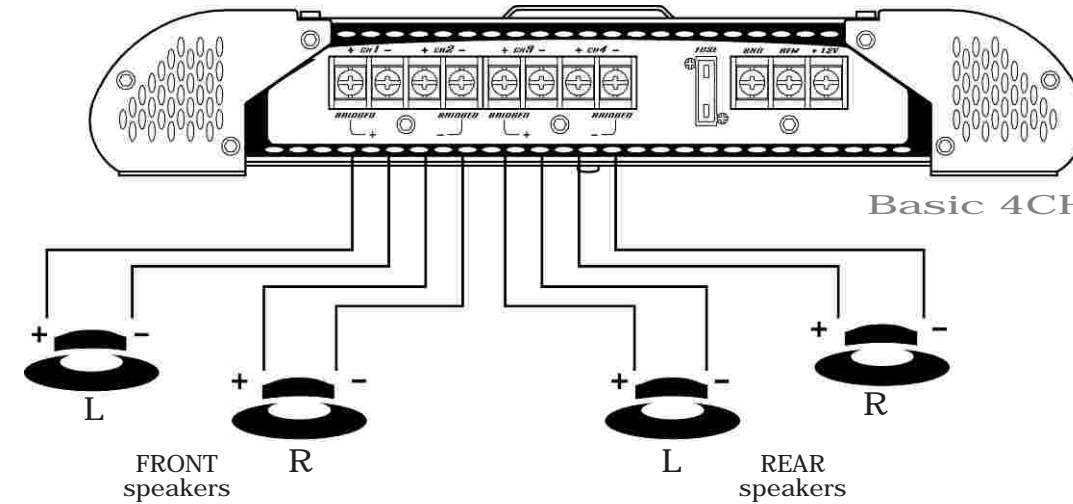

Basic 4CH Output

LA-678  
LA-878  
4CH AMPS

LA-478  
 LA-578  
 LA-778  
 LA-978  
 LA-1478  
 LA-1878  
 LA-2078  
 LA-2278  
 2CH AMPS

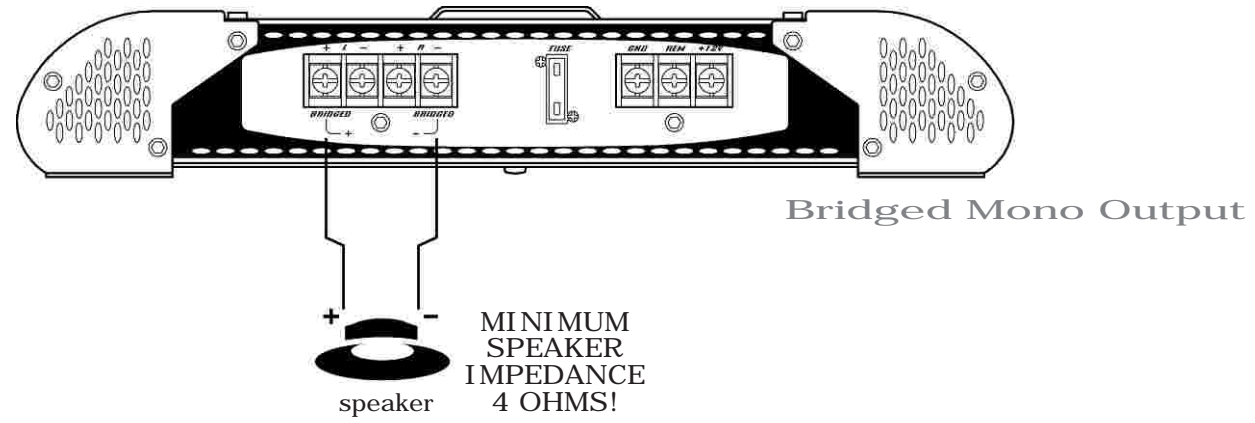

Low Level Stereo Input Connection

LA-2478  
 MONO CHANNEL  
 AMPS

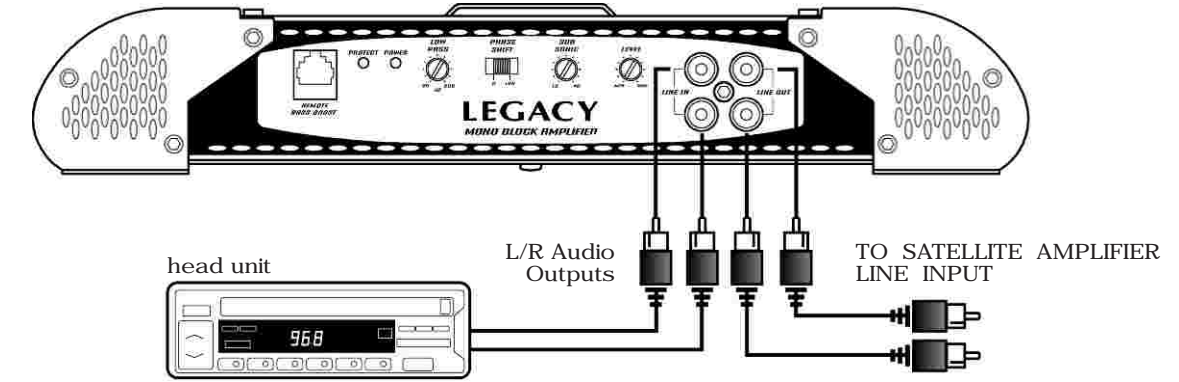

LA-678  
 LA-878  
 4CH AMPS

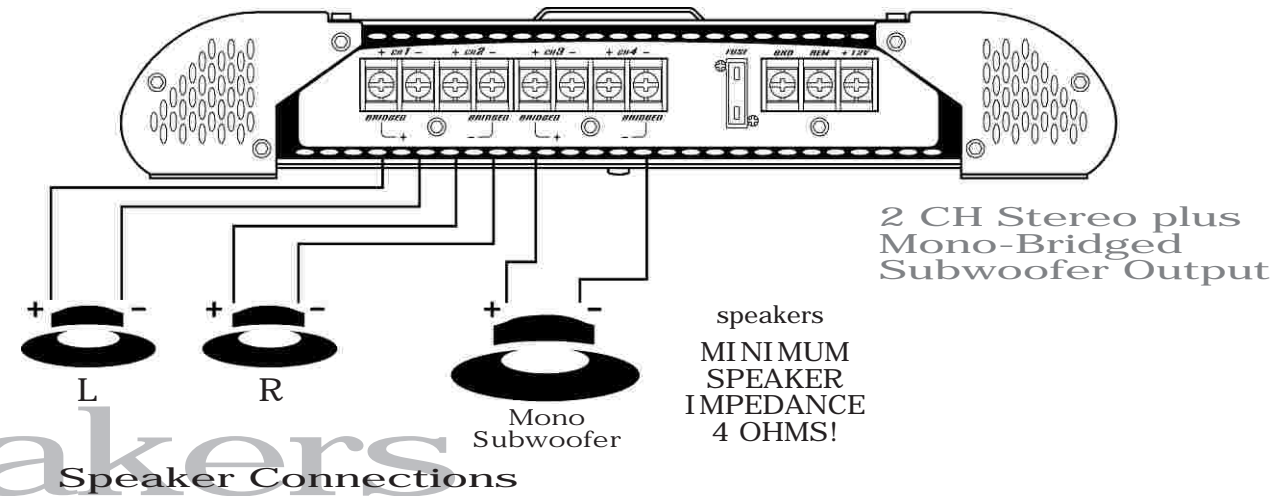
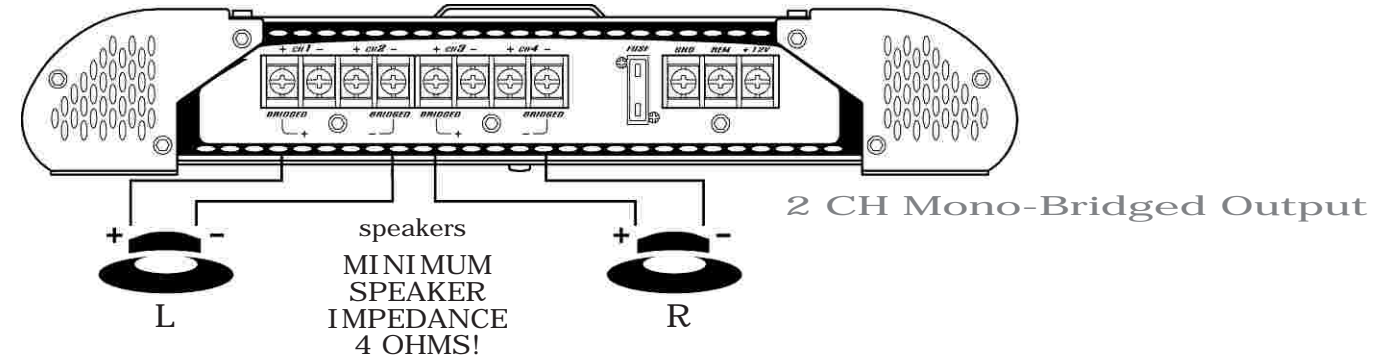

Speakers  
 Speaker Connections

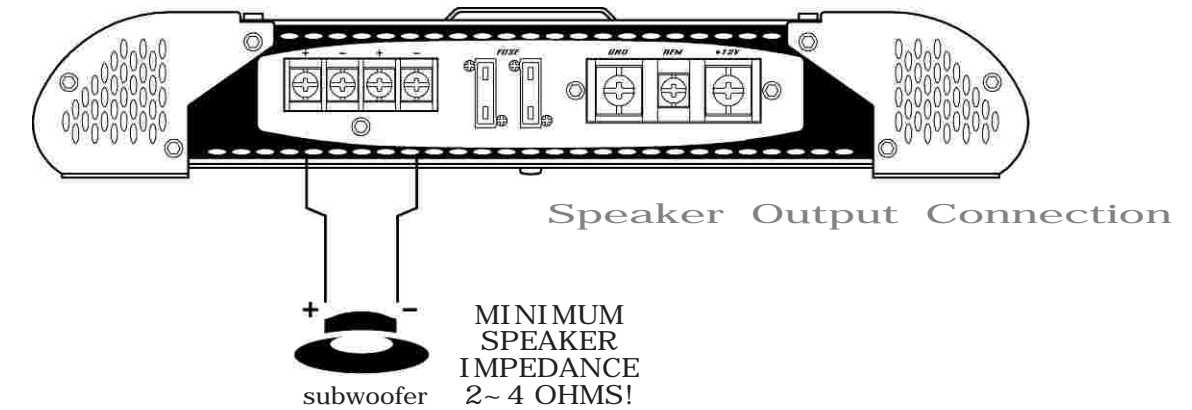

inputs/Speakers  
 Input Connections/Speaker Connection



### Amplifier will not power up.

- Check for good ground connection.
- Check that remote DC terminal has at least +12v DC.
- Check that there is battery power on the + terminal.
- Check all fuses.
- Check that Protection LED is not lit. If it is lit, shut off amplifier briefly and then repower it.

### High hiss or engine noise (alternator whine) in speakers.

- Disconnect all RCA inputs to the amplifier(s) - if hiss/noise disappears, then plug in the component driving the amplifier and unplug its inputs. If hiss/noise disappears, go on until the faulty/noisy component is found.

- It is best to set the amplifier's input level as insensitive as possible. The best subjective S/N ratio is obtainable this way. Try to drive as high a signal level from the head unit as possible.

### Protection LED comes on when the amplifier is powered up.

- Check for shorts on speaker leads.
- Check that the volume control on the head unit is turned down low.
- Remove speaker leads, and reset the amplifier. If the Protection LED still comes on, then the amplifier is faulty.

### Amplifier(s) gets very hot.

- Check that the minimum speaker impedance for that model is correct.
- Check for speaker shorts.
- Check that there is good airflow around the amplifier. In some applications, an external cooling fan may be required.

### Distorted sound

- Check that the Level control(s) is set to match the signal level of the head unit.
- Check that all crossover frequencies are properly set.
- Check for shorts on the speaker leads.

### High squeal noise from speakers.

- This is almost always caused by a poorly-grounded RCA patch cord.

