

# Owner's Manual

AMERICAN CRAFTED PERFORMANCE



*Heritage*

HTG 214/ 224/ 234/ 244/ 254/ 264  
HTG 414/ 424/ 434

## Table of Contents

<b>INTRODUCTION &amp; FEATURES</b> .....	<b>1</b>
<b>FEATURES &amp; CONTROLS</b> .....	<b>2~4</b>
2 Channel .....	<b>2</b>
4 Channel .....	<b>3</b>
<b>SPECIFICATIONS</b> .....	<b>5~6</b>
<b>INSTALLATION &amp; PRECAUTIONS</b> .....	<b>7</b>
<b>SYSTEM WIRING</b> .....	<b>8~14</b>
2Channel stereo configuration .....	<b>8</b>
2Channel bridged mode configuration .....	<b>9</b>
2Channel tri-mode configuration .....	<b>10</b>
Tri-amp system using three 2 Channel amplifiers .....	<b>11</b>
4Channel stereo configuration .....	<b>12</b>
4Channel bridged mode configuration .....	<b>13</b>
4Channel tri-mode configuration .....	<b>14</b>
<b>TROUBLESHOOTING</b> .....	<b>15</b>
<b>WIRING</b> .....	<b>16</b>

### Introduction

Congratulations on your purchase of a Lanza Heritage amplifier. You have purchased a quality product designed and engineered to give you many years of uncompromised musical service. Heritage amplifiers are designed with the latest technology available, incorporating a DC to DC Switching Power Supply, which provides headroom for even the most demanding peaks and dynamic ranges found on modern CD's and recordings.

### Features

- MOSFET switches maintain rated power over a wide range of battery voltages
- Stiffly regulated PWM- type power supplies
- 2 Ohm Stable Stereo operation
- Stereo, Bridge Mode and Tri-Mode System Application Compatible
- Variable input level controls for each pair of channels
- Variable high and low pass crossover controls
- Thermal and speaker short protection circuitry
- Power and Protection LED indicators
- Bass Boost Circuitry
- Nickel plated power, RCA and speaker connectors
- High-efficiency, heavy aluminum heatsink
- Bass Boost Remote control

## Features & Controls

### 2 Channel

HTG 214/ 224/ 234/ 244/ 254/ 264

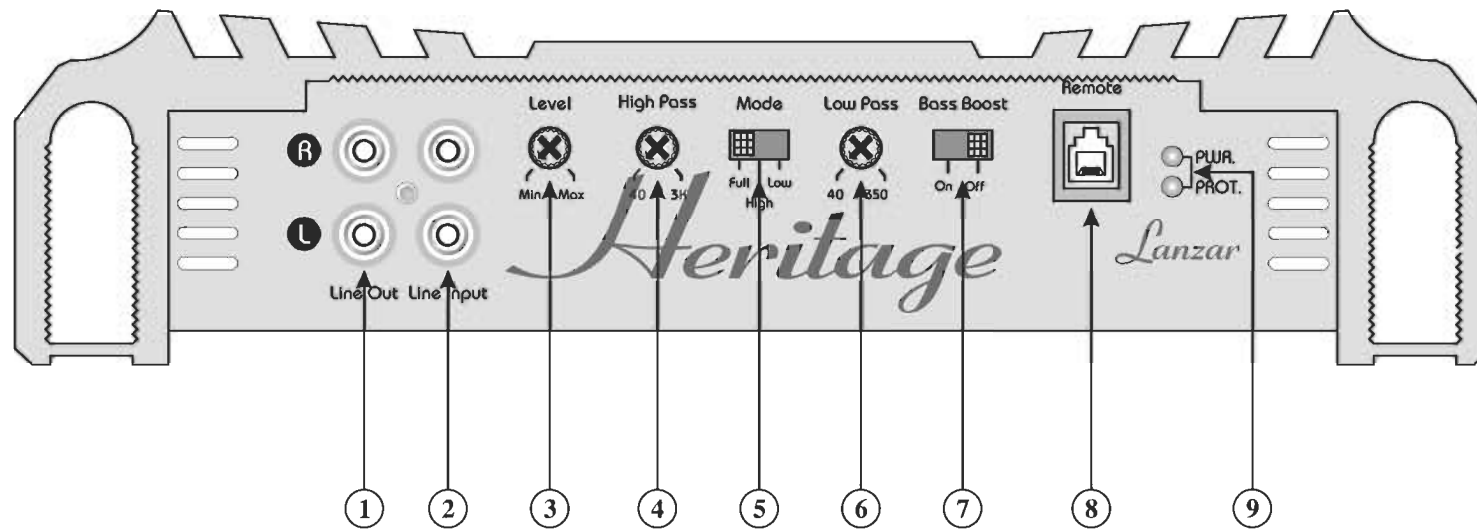

4 Channel

HTG 414/ 424/ 434

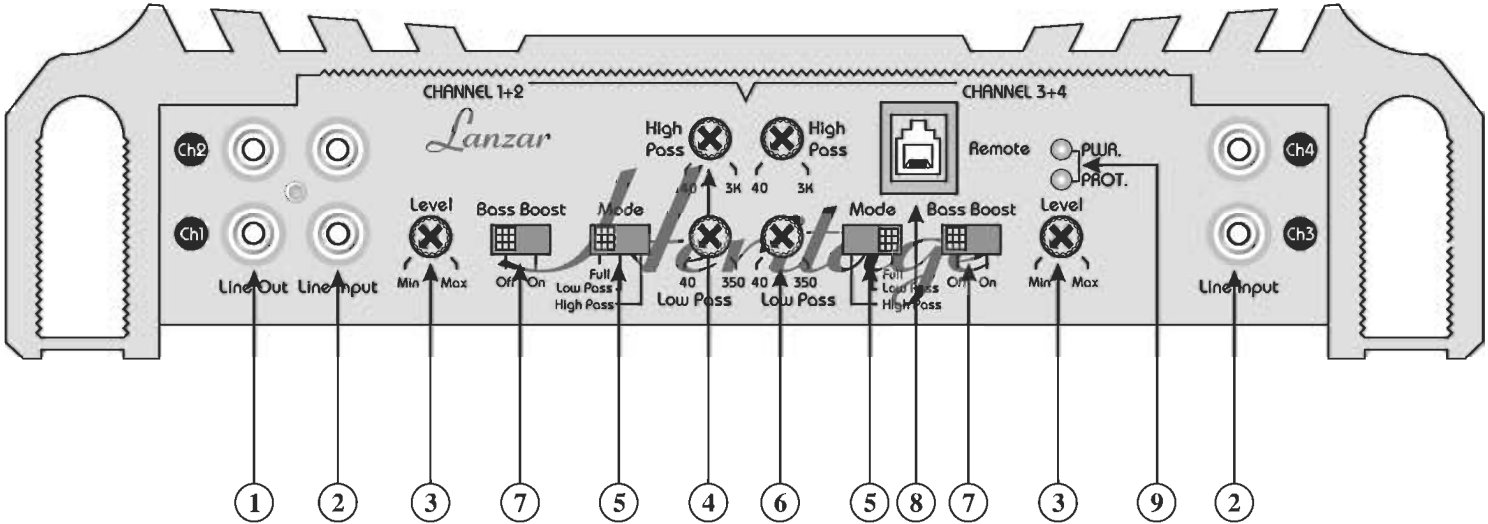

## Features & Controls

### Features & Controls

- 1. Line Out RCA Jacks** - The LINE OUT allows you to build multiple amplifier systems without having to use splitter cords to distribute the signal. Now it is simple a matter of bringing one set of RCAs into the first amplifier, then using the line out RCA jacks as the feed to the next amplifier.
- 2. Line Input RCA Jacks** - These inputs are for signal cables from the source. Always use high quality shielded RCA cables.
- 3. Input Level Controls**- Enables the matching of input levels to the output levels from the head unit(or other signal source).
- 4.High Pass Filter**- When Crossover Mode Selector is in High Pass Mode, this control limits the frequencies which will be distributed to the speakers to those above the value to this is set within the range 40Hz ~ 3kHz.
- 5.Crossover Mode Selector**- Determines the mode of built-in crossover: low pass ( permits only low frequency signals to pass to speakers), high pass ( permits only high frequency signals to pass to speakers), or flat.
- 6.Low Pass Filter**- When Crossover Mode Selector is in Low Pass Mode, this control limits the frequencies which will be distributed to the speakers to those below the value to which this is set within the range 40~ 350Hz.
- 7.Bass Boost Switch and Variable**-ON and OFF
- 8.Bass Boost Remote Control Input**
- 9.Power & Protection Indicators**- Provide instant information on status of amplifier, including short-circuit and thermal overload alerts.

## Specifications

### Specifications

Model	HTG214 2Channel amplifier	HTG224 2Channel amplifier	HTG234 2Channel amplifier	HTG244 2Channel amplifier
<b>RMS at 4 Ohms</b>	2 x 90W	2 x 150W	2 x 200W	2 x 250W
<b>MAX at 4 Ohms</b>	2 x 180W	2 x 300W	2 x 400W	2 x 500W
<b>At 4 Ohms Bridged</b>	1 x 360W	1 x 600W	1 x 800W	1 x 1000W
<b>RMS at 2 Ohms</b>	2 x 150W	2 x 250W	2 x 350W	2 x 420W
<b>Min. Speaker Impedance</b>	2 Ohm	2 Ohm	2 Ohm	2 Ohm
<b>T.H.D</b>	0.04%	0.04%	0.04%	0.04%
<b>Frequency Response</b>	10Hz~35kHz, -1dB	10Hz~35kHz, -1dB	10Hz~35kHz, -1dB	10Hz~35kHz, -1dB
<b>Input Sensitivity</b>	100mV-4000mV	100mV-4000mV	100mV-4000mV	100mV-4000mV
<b>Input Impedance</b>	22kOhm	22kOhm	22kOhm	22kOhm
<b>S/N Ratio</b>	>90dB	>90dB	>90dB	>90dB
<b>Channel Separation</b>	>65dB	>65dB	>65dB	>65dB
<b>Low pass Filter</b>	40Hz~350Hz	40Hz~350Hz	40Hz~350Hz	40Hz~350Hz
<b>High pass Filter</b>	40Hz~3kHz	40Hz~3kHz	40Hz~3kHz	40Hz~3kHz
<b>Bass Boost</b>	+12dB	+12dB	+12dB	+12dB
<b>Dimensions(Inches)</b>	9.82" x 2.34" x 7.17"	9.82" x 2.34" x 8.27"	9.82" x 2.34" x 9.92"	9.82" x 2.34" x 13.46"
<b>Fuse</b>	15A	20A	25A	20A x 2

# Specifications

## Specifications

HTG254 2Channel amplifier	HTG264 2Channel amplifier	HTG414 4Channel amplifier	HTG424 4Channel amplifier	HTG434 4Channel amplifier
2 x 400W	2 x 600W	4 x 75W	4 x 125W	4 x 150W
2 x 800W	2 x 1200W	4 x 150W	4 X 250W	4 x 300W
1 x 1600W	1 x 2400W	2 x 300W	2 x 500W	2 x 600W
2 x 650W	2 x 1000W	4 x 125W	4 x 200W	4 x 250W
2 Ohm	2 Ohm	2 Ohm	2 Ohm	2 Ohm
0.04%	0.04%	0.04%	0.04%	0.04%
10Hz~35kHz, -1dB	10Hz~35kHz, -1dB	10Hz~35kHz, -1dB	10Hz~35kHz, -1dB	10Hz~35kHz, -1dB
100mV-4000mV	100mV-4000mV	100mV-4000mV	100mV-4000mV	100mV-4000mV
22kOhm	22kOhm	22kOhm	22kOhm	22kOhm
>90dB	>90dB	>90dB	>90dB	>90dB
>65dB	>65dB	>65dB	>65dB	>65dB
40Hz~350Hz	40Hz~350Hz	40Hz~350Hz	40Hz~350Hz	40Hz~350Hz
40Hz~3kHz	40Hz~3kHz	40Hz~3kHz	40Hz~3kHz	40Hz~3kHz
+12dB	+12dB	+12dB	+12dB	+12dB
9.82" x 2.34" x 17.83"	9.82"x 2.34" x 20.47"	9.82" x 2.34" x 11.46"	9.82" x 2.34" x 12.91"	9.82"x 2.34" x 15.63"
25A x 2	40A x 2	15A x 2	20A x 2	25A x 2



## Installation

1. Find a suitable location in the vehicle to mount the amplifier.
2. Make sure there is sufficient air flow around the intended mounting location.
3. Bolt the amplifier to the mounting surface.
4. Connect the power ground terminal to the nearest point on the chassis of the car. Keep this ground wire less than one meter (39") in length. Use 8 gauge wire.
5. Connect the remote terminal to the remote output of the head unit using 14 gauge wire.
6. Connect an empty fuse holder within 300 mm (12") of the battery and run 8 gauge or larger high quality cable from this fuse to the amplifier location.
7. Make sure there is no fuse in this fuse holder. Then make the connection to the "BATT" connection on the amplifier.
8. If multiple amplifiers are being used, use cables (each with it's own fuse at the battery) or a # 0 or #2 cable from the fuse holder at the battery to a distribution block at or near the amplifier's location.
9. Connect all line inputs and outputs using high-quality RCA-RCA cables.
10. Insert fuse(s) at the battery fuse holder(s).
11. Recheck all connections before powering up.
12. Set all level controls to their least sensitive positions and set all crossover controls, switches, etc. To the desired frequency or position.
13. Once the system is powered up, set the volume control on the head unit to about the 2 O'clock position, and then set all the amplifiers' level controls for maximum output level.
14. Further fine tuning of the various controls may be m'necessary to obtain the desired results.

## Precautions

1. Before you drill or cut any holes, investigate your car's layout very carefully. Take care when you work near the gas tank, fuel lines, hydraulic lines and electrical wiring.
2. Do not operate the amplifier when it is unmounted. Attach all audio system components securely within the automobile to prevent damage, especially in an accident.
3. Do not mount this amplifier so that the wire connections are unprotected or in a pinched condition, or likely to be damaged by nearby objects. Be sure to select a location inside your vehicle which has adequate ventilation.
4. Before making or breaking power connections in your system, disconnect the vehicle battery. Confirm that your head unit or other equipment is turned off while connecting the input jacks and speaker terminals.
5. If you need to replace the power fuse, only replace it with a fuse identical to that supplied with the system. Using a fuse fo a different type or rating may result in damage to your system which isn't covered by the manufacturer's warranty.

# System Wiring

## 2 Channel Stereo Configuration

HTG 214/ 224/ 234/ 244/ 254/ 264

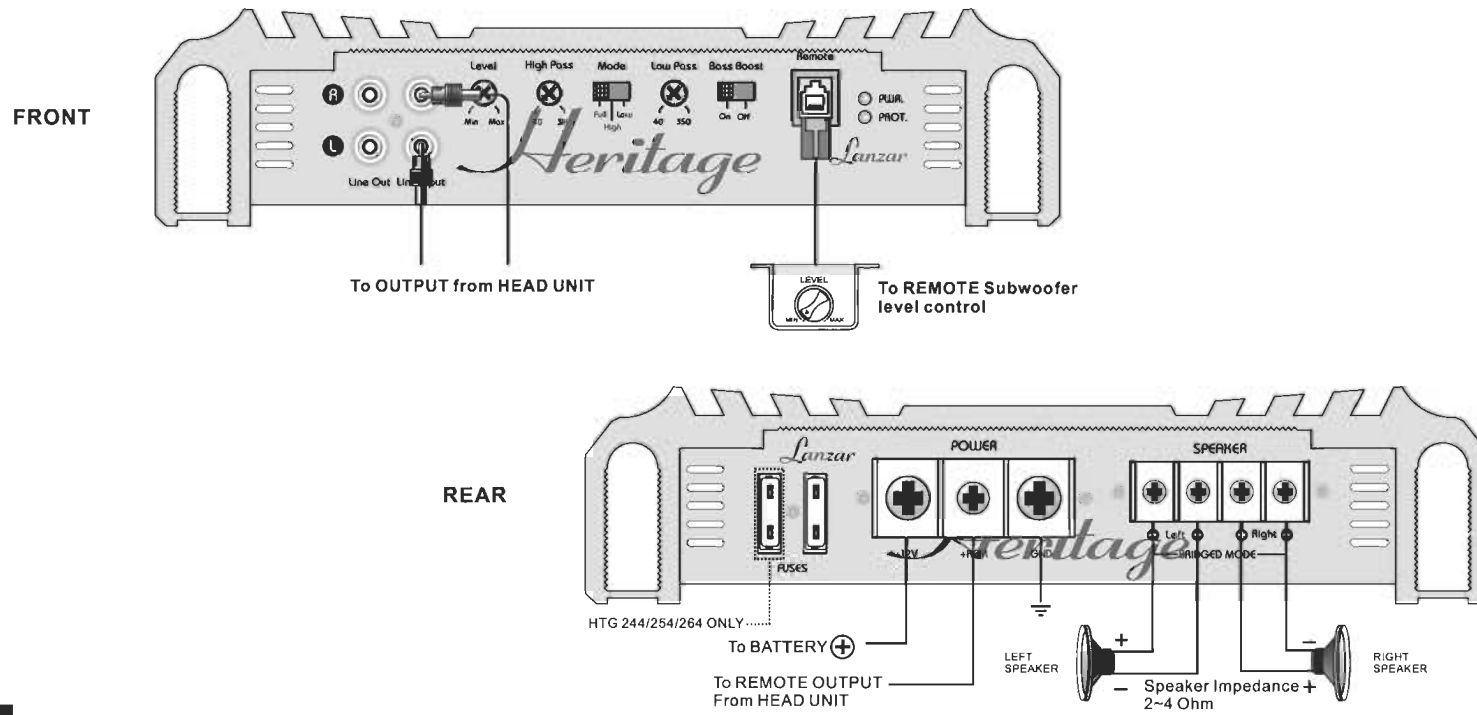

2 Channel Bridged Mode Configuration

HTG 214/ 224/ 234/ 244/ 254/ 264

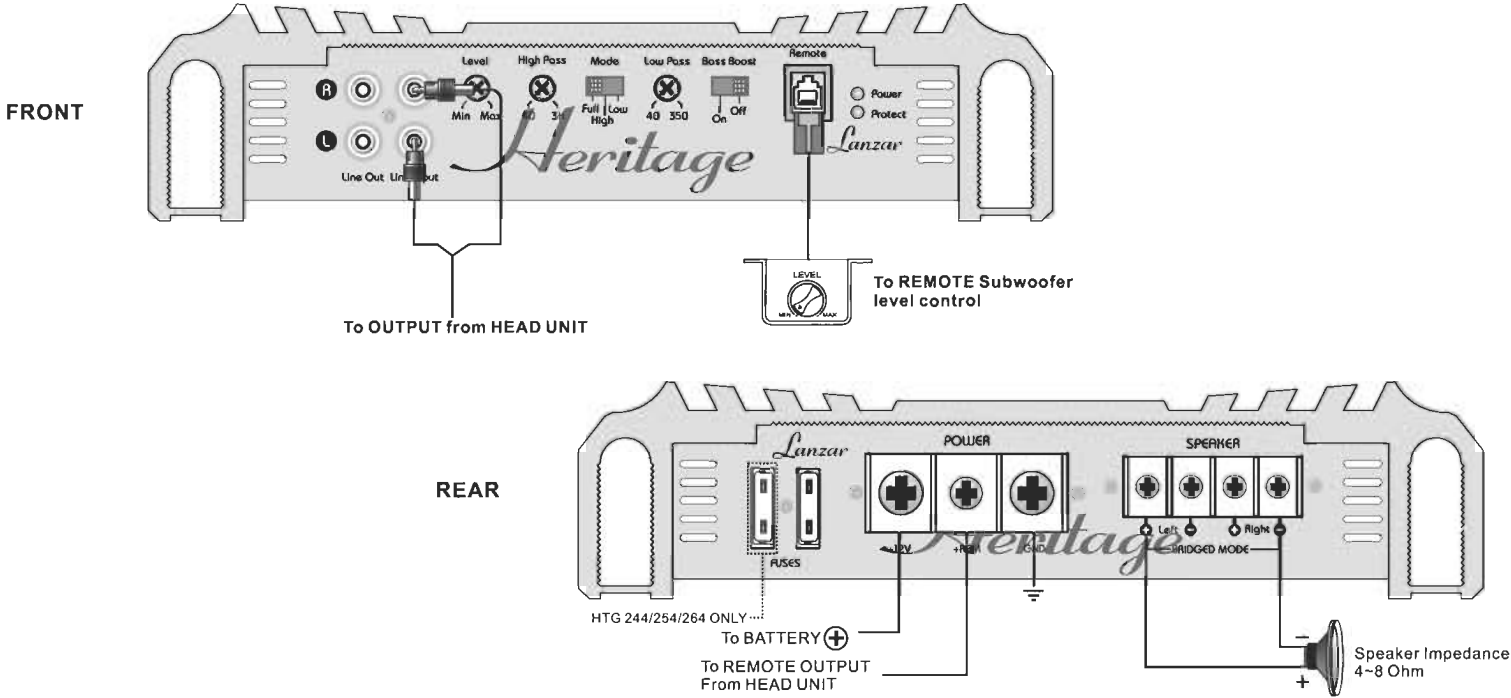

# System Wiring

## 2 Channel Tri-Mode Configuration

HTG 214/ 224/ 234/ 244/ 254/ 264

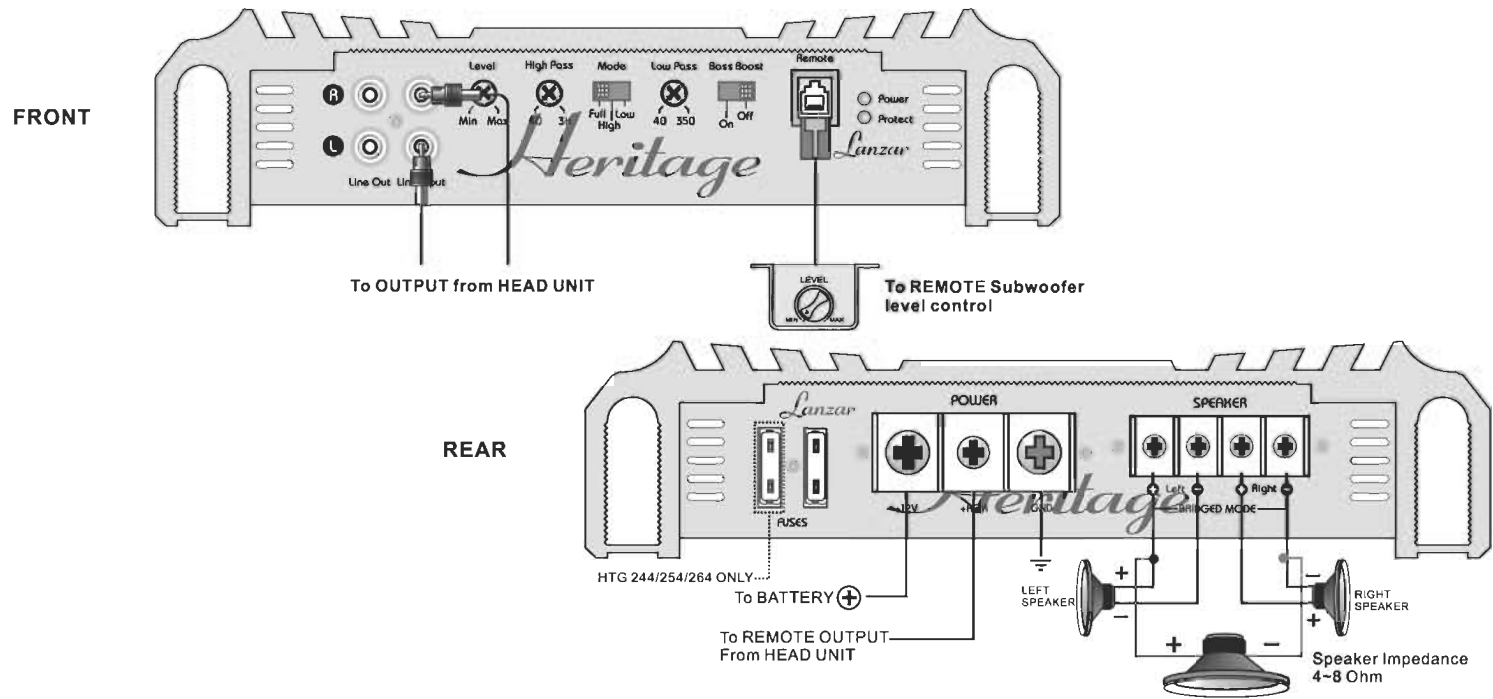

## Tri-Amp System Using Three 2 Channel Amplifiers

HTG 214/ 224/ 234/ 244/ 254/ 264

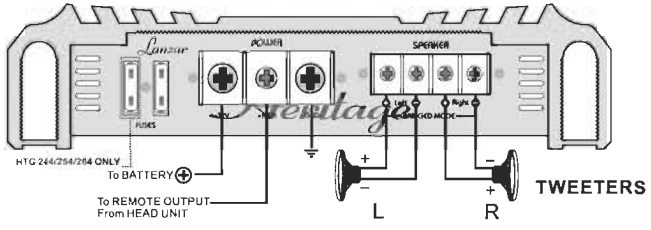
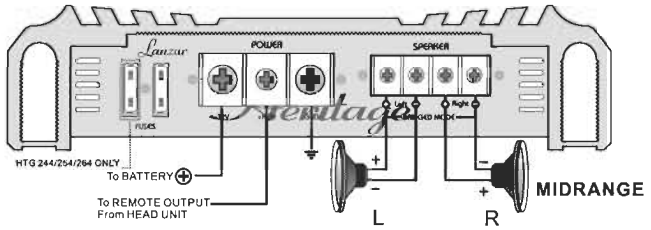
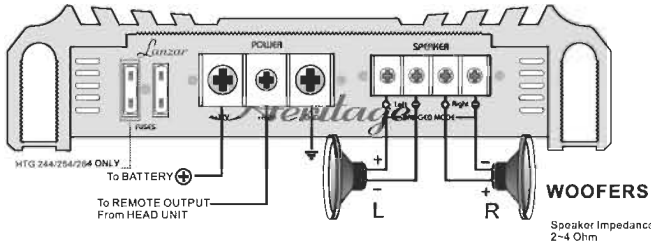
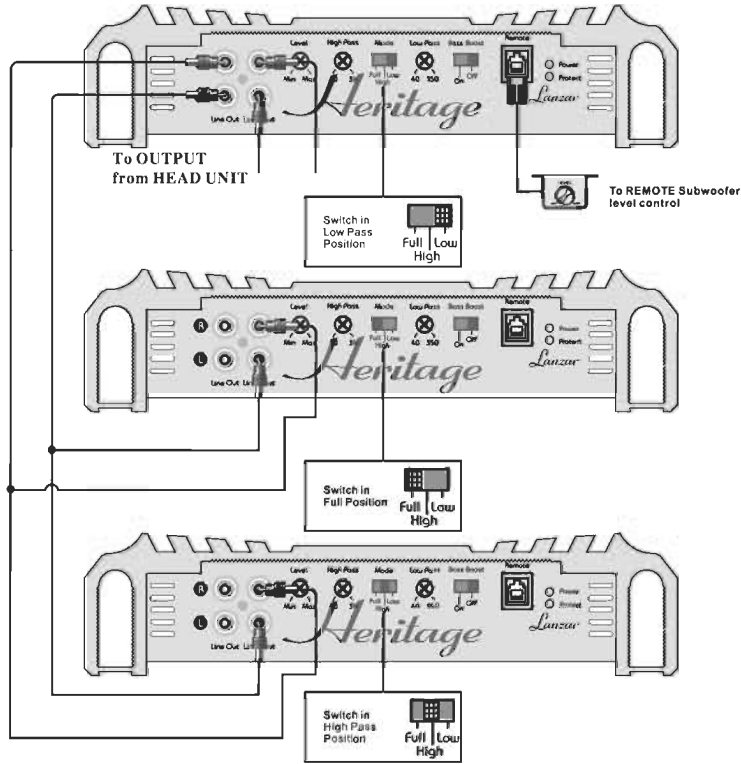

# System Wiring

## 4 Channel Stereo Configuration

HTG 414/424/434

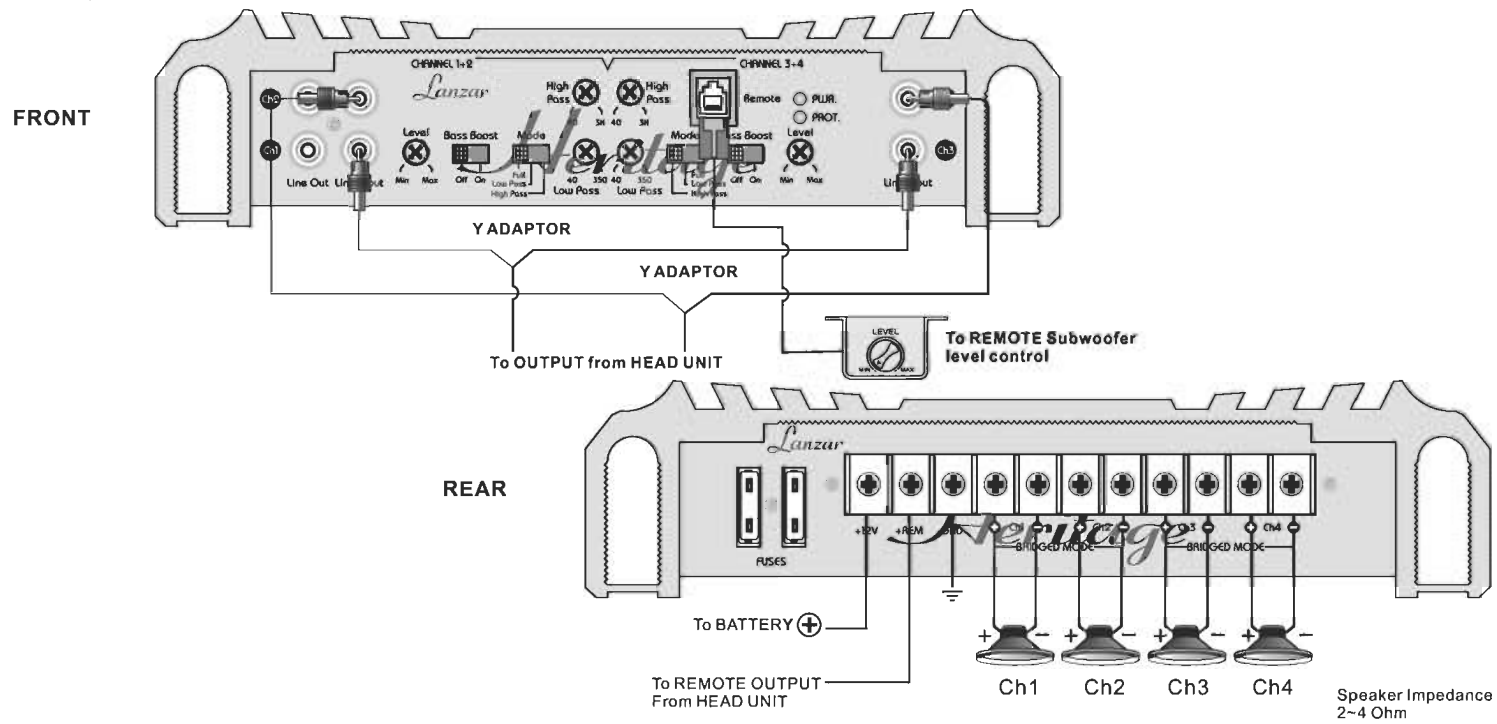

### 4 Channel Bridged Mode Configuration

HTG 414/424/434

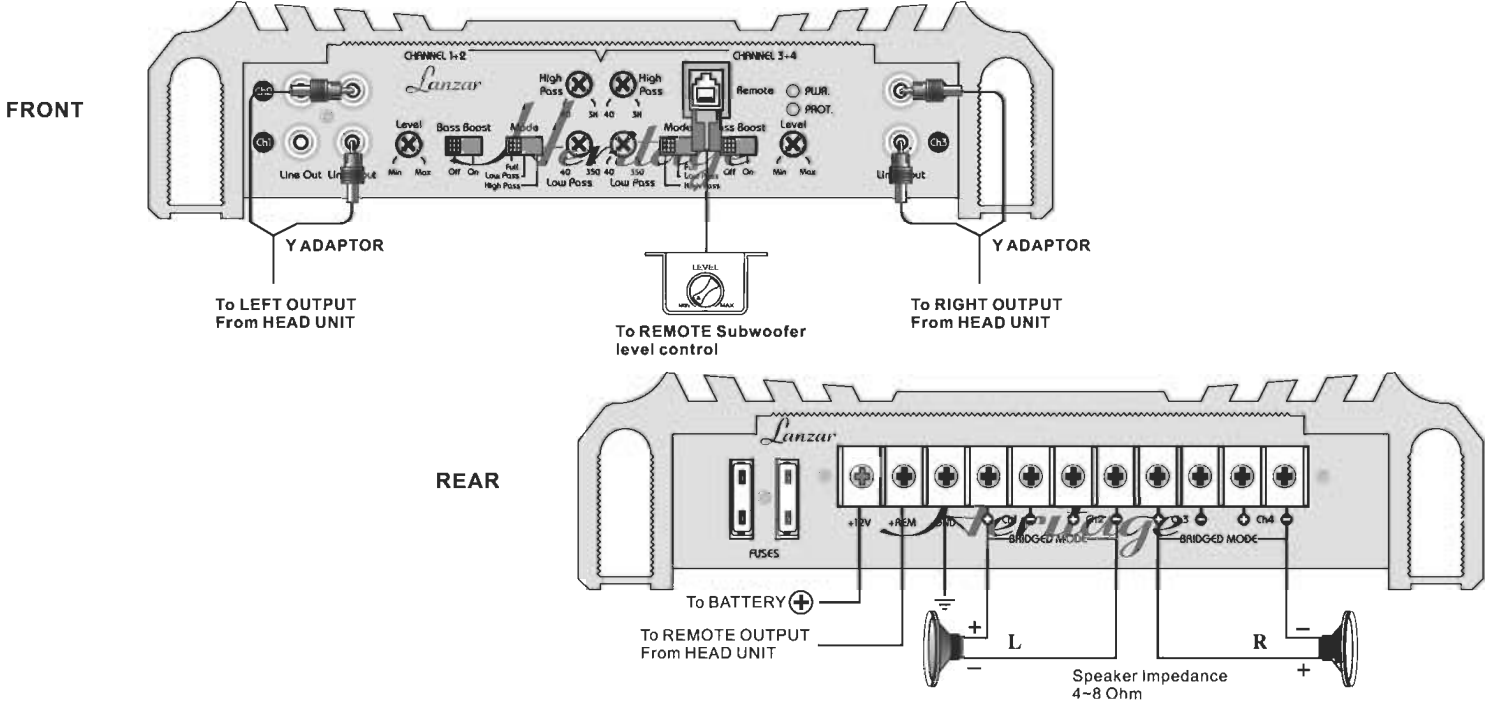

# System Wiring

## 4 Channel Tri-Mode Configuration

HTG 414/424/434

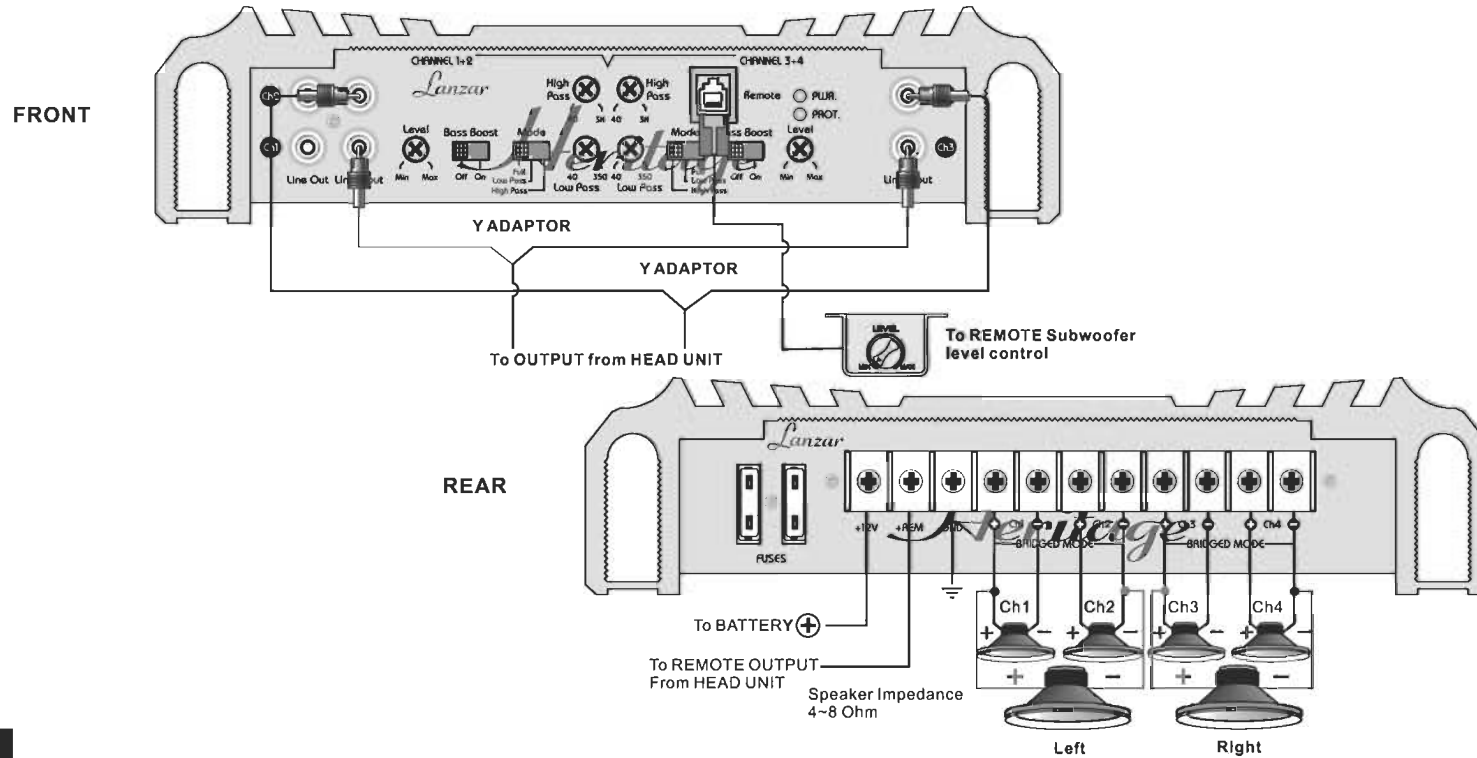



## Troubleshooting

### **Amplifier will not power up.**

- Check for good ground connection.
- Check that remote DC terminal has at least 3V DC.
- Check that there is battery power on the + terminal.
- Check all fuses.
- Check that Protection LED is not lit. If it is lit, shut off amplifier briefly and then repower it.

### **High hiss or engine noise (alternator whine) in speakers.**

- Disconnect all RCA inputs to the amplifier(s)-if hiss/noise disappears, then plug in the component driving the amplifier and unplug it's inputs. If hiss/noise disappears, go on until the faulty/noisy component is found.
- It is best to set the amplifier's input level as low as possible. The best subjective S/N ratio is obtainable this way. Try to drive as high a signal level from the head unit as possible.

### **Protection LED comes on when the amplifier is powered up.**

- Check for shorts on speaker leads.
- Check that the volume control on the head unit is turned down low.
- Remove speaker leads, and reset the amplifier. If the Protection LED still comes on, then the amplifier is faulty.

### **Amplifier(s) gets very hot.**

- Check that the minimum speaker impedance for that model is correct.
- Check for speaker shorts.
- Check that there is good airflow around the amplifier. In some applications, an external cooling fan may be required.

### **Distorted Sound**

- Check that the Level control(s) is set to match the signal level of the head unit.
- Check that all crossover frequencies have been properly set.
- Check for shorts on the speaker leads.

### **High squeal noise from speakers.**

- This is almost always caused by a poorly-grounded RCA patch cord.

# Wiring

## Wiring

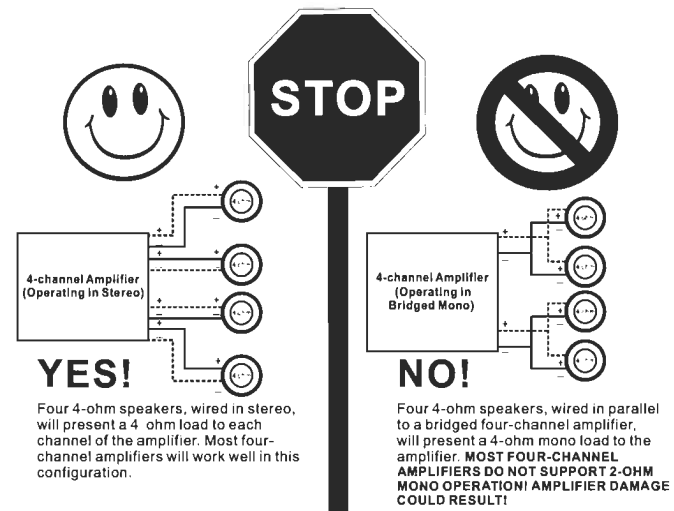
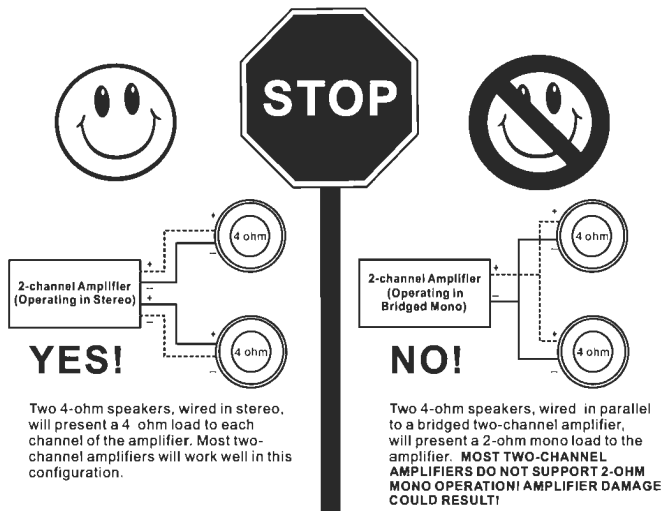

SOUND AROUND, INC.  
1600 63RD STREET • BROOKLYN, NY 11204



**Lanzar Audio Inc.**  
1600 63rd Street, Brooklyn, NY 11204  
(718) 236-6948  
[www.lanzar.com](http://www.lanzar.com)



PRINTED IN KOREA