

KENWOOD

KAC-816

MONO POWER AMPLIFIER

INSTRUCTION MANUAL

KENWOOD CORPORATION

Safety precautions

▲WARNING

Take the following precautions to prevent fire and avoid personal injury :

- When extending the battery cable, or ground cable, use 5mm² (AWG10) or larger automotive grade cable to avoid cable deterioration or damage to the covering.
- Check that no metal objects (coins, tools, etc.) are left inside the unit to avoid short circuits.
- If you smell or see smoke, turn the power off immediately and consult your Kenwood dealer.
- Do not touch the unit during use because the surface of the unit becomes hot and may cause burns if touched.

▲CAUTION

Take the following precautions to keep the unit in proper working order.

- Be sure the unit is connected to a 12V DC power supply with a negative ground connection.

- Do not open the top or bottom cover.
- Do not install the unit in places it is exposed to direct sunlight, high heat or humidity, water may splash over it, or dust exists.

NOTE

If you have difficulty in installing this unit in your vehicle, contact your Kenwood dealer.









Cleaning the unit

If the surface is dirty, wipe it clean with a silicon cloth or soft dry cloth with the power off.

▲CAUTION

Do not use hard cloths or paint thinner, alcohol, or other volatile solvents. These may damage external surfaces or remove indicator characters.

Accessories

Part name	External View	Number of Items	Part name	External View	Number of Items
Battery cable (Yellow) (6 m)		1	Round terminal (Large)		1
Ground cable (Black) (1 m)		1	Round terminal (Medium)		2
Self-tapping screws (ø4 × 16 mm)		4	Round terminal (Small)		1
Terminal cover (Power terminal)		1	Grommets		1

Installation procedure

1. Remove the ignition key and disconnect the negative \ominus terminal of the battery to prevent short circuits.
2. Set the unit according to the intended usage.
3. Connect the input and output cables of the units.
4. Connect the center unit and this unit according to the required application.
5. Connect the speaker cables and sigma servo feed back cables.
6. Connect the power cable, power control cable and grounding cable following this order.
7. Install the unit in the car.
8. Connect the negative \ominus terminal of the battery.
9. Turn power ON and ensure that sound is output normally.

▲CAUTION

- If sound is not output normally, immediately turn power off and check connections. Be sure to perform the sigma servo connection correctly.
- Be sure to make correct connections of the sigma servo terminals.
- Be sure to turn the power off before changing the setting of any switch.
- If the fuse blows, check cables for shorts, then replace the fuse with one of the same rating.
- Check that no unconnected cables or connectors are touching the car body. Do not remove caps from unconnected cables or connectors to prevent short circuits.
- Connect the speaker cables to appropriate speaker connectors separately. Sharing the negative cable of the speaker or grounding speaker cables to the metal body of the car can cause this unit to fail.
- After installation, check that the brake lamps, wipers, and wipers work properly.

Installation

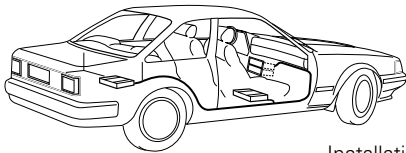

Self-tapping screw
($\phi 4 \times 16$ mm)

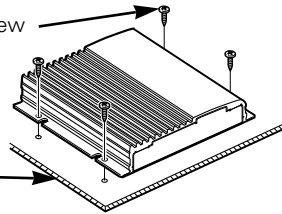

Installation board, etc.
(thickness : 15 mm or more)

- Since the power amplifier has no parts which require operation, it can be installed at a position away from the driver's seat without any hindrances.
As generally accepted positions for its installation, places such as inside the trunk, etc. can be considered.
- Use the extension cables. (Optional)

Type	Length	0.5m	1m	2m	4m	5m	6m
RCA cable		CA-2SL	CA-12SL	CA-22SL	—	CA-52SL	—
RCA cable ($\phi 7$ mm)		CA-3WL	CA-13WL	CA-23WL	—	CA-53WL	—
RCA cable ($\phi 12$ mm)		CA-5W	CA-15W	CA-25W	CA-45W	—	CA-65W

▲CAUTION

- Do not install the unit under the carpet. Otherwise heat build-up occurs and the unit may be damaged.
- Install this unit in a location which allows heat to easily dissipate.
Once installed, do not place any object on top of the unit.
- Install the unit securely in a location that does not interfere with driving.

Controls

Operations of the following control and switches are required in accordance with the center unit and speakers connected with this unit.

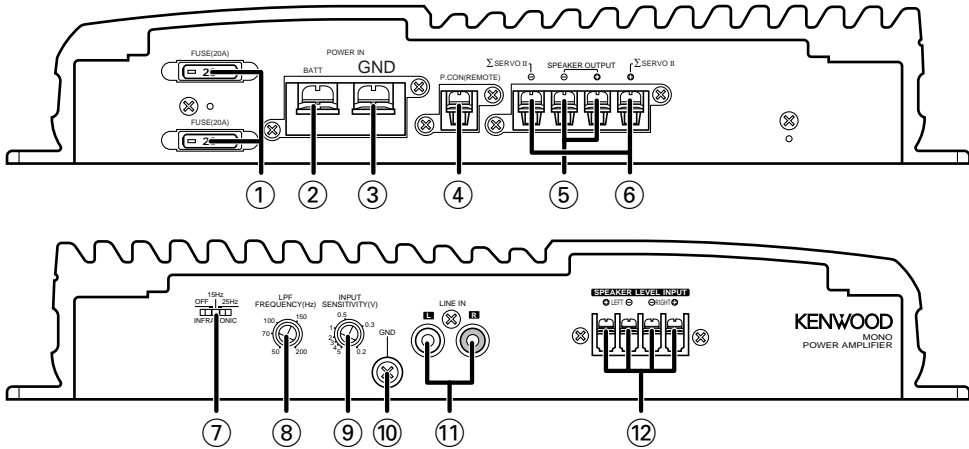

- ① FUSE (20 A × 2)
- ② Battery terminal
- ③ Ground terminal
- ④ Power control (REMOTE) terminal
- ⑤ Speaker output terminals

As this unit accepts speakers with a minimum impedance of 2 ohms, connect speakers with 2-ohm or higher impedance to these terminals.

▲CAUTION

The rated input of the speakers should be no less than the maximum output of the amplifier. Otherwise malfunction may result.

- ⑥ SIGMA SERVO FEED BACK terminals (See p.8)

▲CAUTION

Be sure to make proper connections to the SIGMA SERVO FEED BACK terminals. Incorrect connection may result in lack of sound output or other malfunctions.

- ⑦ INFRASONIC FILTER switch

Ultralow frequencies that cannot be reproduced even by a subwoofer speaker do not become sound but become unnecessary oscillations, which affect the sound by causing distortion, etc. Setting this switch to "15 Hz" or "25 Hz" cuts the frequencies below the respective frequency.

This improves the reproduction performance of the speakers by eliminating unnecessary oscillations which will not become sound.

- ⑧ LOW PASS FILTER FREQUENCY control

This control adjusts the frequency band output from this unit.

- ⑨ INPUT SENSITIVITY control

Set this control according to the pre-output level of the center unit connected with this unit, or to the maximum power output of the genuine-accessory car stereo.

Use the diagram on the right as a guide.

NOTE

For the pre-output level or the maximum power output, refer to the "Specifications" in the instruction manual of the center unit.

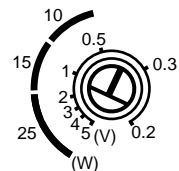

- ⑩ RCA cable ground lead terminal
- ⑪ LINE IN terminal
- ⑫ Speaker level input terminals

Power indicator

■ Power indicator:

When the power is turned on, the Power indicator lights.

If the Power indicator does not light when the power is turned on, the protection function may be activated. Check whether there is any indication of trouble.

■ The protection function is activated in the following situations:

This unit is equipped with a protection function for protecting this unit and your speakers from various accidents or problems that can occur. When the protection function is triggered, the Power indicator goes off and the amplifier stops operating.

- A speaker cable may be short-circuited.
- A speaker output may be in contact with the ground.
- The temperature of the internal parts may be higher than 120°C (248°F).
- The sigma servo connection may be erroneous.
- The fuse of this unit may be blown.
- The unit may be malfunctioning and sending DC signal to the speaker output.
- The grounding cable of this unit may not be connected with a metallic part which is electrically connected with the negative terminal of the battery.
- The power control cable may not be connected to this unit.
- The grounding cable of the center unit (cassette receiver, CD receiver, etc.) may not be connected with a metallic part which is electrically connected with the negative terminal of the battery.

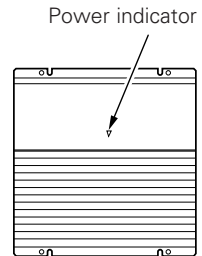

Connection

■ RCA cable connection

▲CAUTION

Do not connect cables and leads to both RCA cable input jacks and the speaker input terminals simultaneously, for this may cause malfunction or damage.

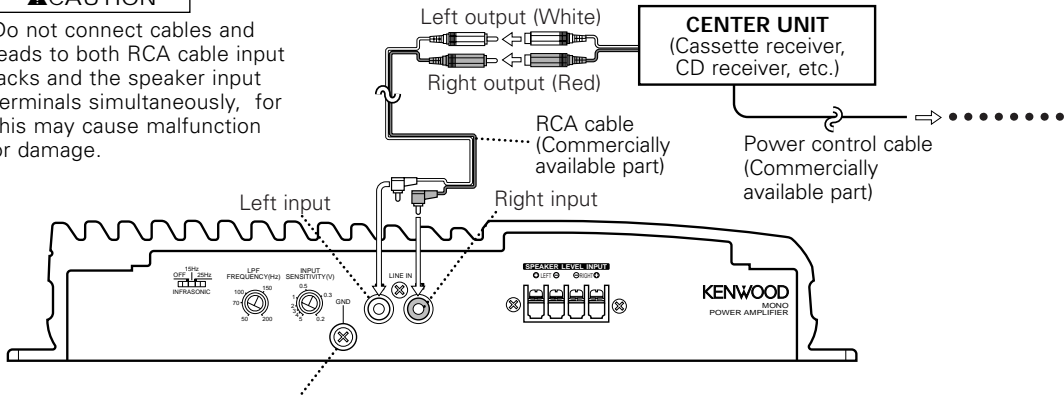

RCA cable ground terminal

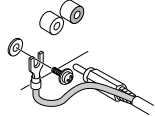

When using an RCA cable with a ground lead attached, connect the ground lead to this terminal.

▲CAUTION

Do not use this terminal for power source grounding. This unit will be damaged if the power source grounding wire is connected to this terminal.

■ Speaker level input connection

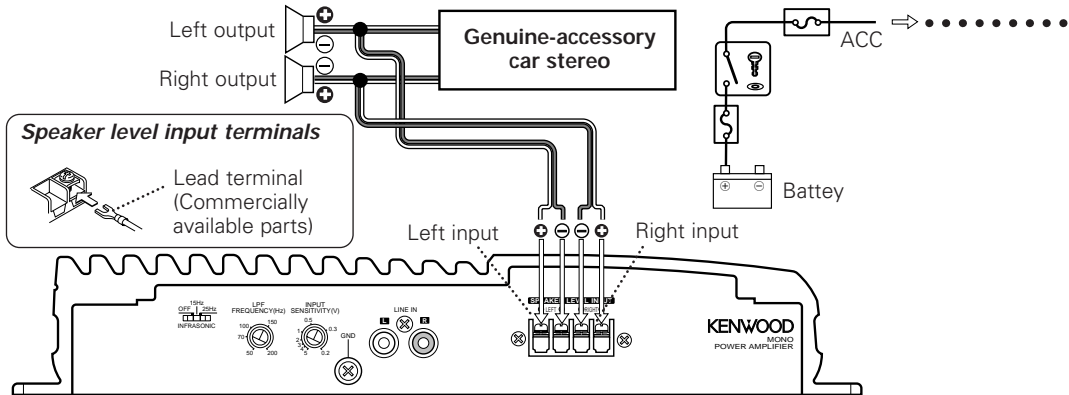

Speaker level input terminals

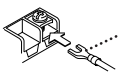

Lead terminal (Commercially available parts)

▲CAUTION

- The genuine-accessory car stereo shall have a maximum power output of no more than 25 W.
- Do not connect the speaker output leads from a power amplifier (Optional) to the speaker input terminals of this unit, for this may cause malfunction or damage.
- Do not connect cables and leads to both RCA cable input jacks and the speaker input terminals simultaneously, for this may cause malfunction or damage.
- Connect the power control lead to a power supply which can be turned ON/OFF by the ignition key switch (ACC line).
With this connection, shock noise may be generated when the power of the genuine-accessory car stereo is switched ON/OFF.

■ Power and Speakers cable connection

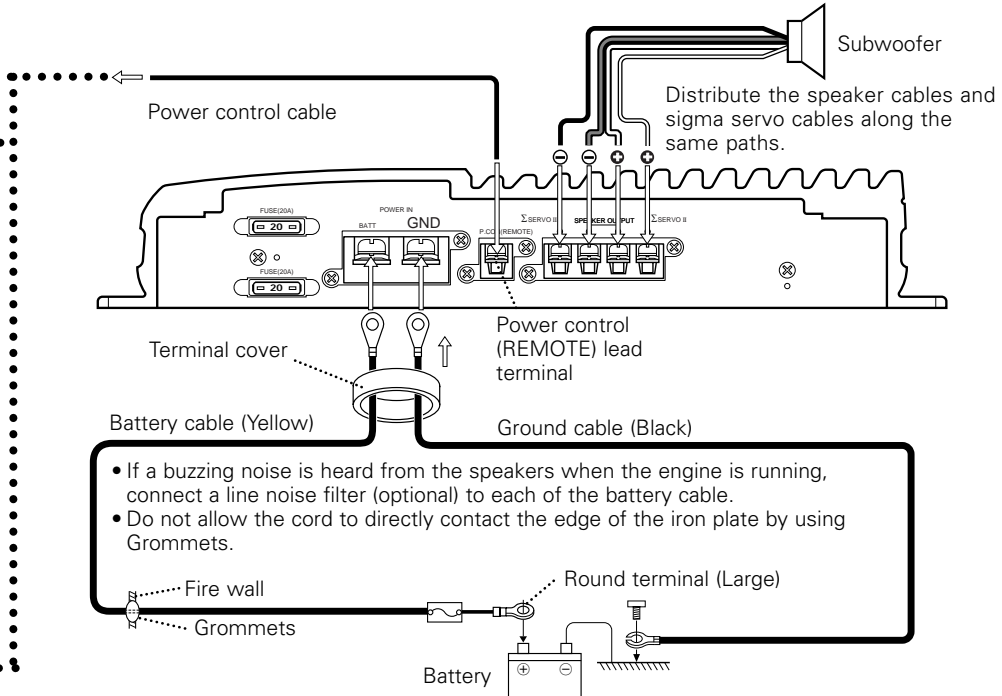

▲WARNING

To prevent fire caused by a short in the wiring, connect a fusible link or breaker nearby the battery's positive terminal.

NOTE

- Connect the ground cable to a metal part of the car chassis that acts as an electrical ground passing electricity to the battery's negative ⊖ terminal. Do not turn the power on if the ground cable is not connected.
- When installing two amplifiers, connect a power tune-up cable to each of them while taking care not to exceed the cable capacity.
- The power cable should be thick enough to supply the required current and connected directly from the battery.

Speaker output cable terminal

Connect the speaker output cables to these terminals.

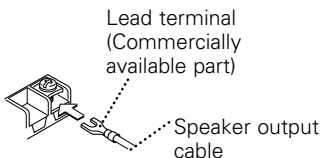

Power terminal

Pass battery and ground cables through supplied terminal cover and connect to respective terminals. After completing connections, fasten terminal cover over terminal bracket.

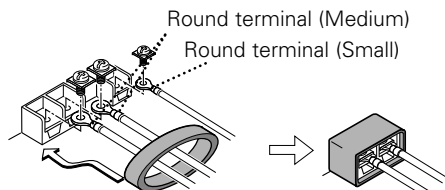

Sigma servo feed back

The sound reproduced through conventional amplifiers is distorted due to the counterelectromotive force produced in the oscillating system of the speaker. The counterelectromotive force is particularly high with the woofer which requires a large drive mass. The sigma servo connection reduces distortion caused by the counterelectromotive force by including the circuit up to the speaker terminals in the negative feedback loop. This makes it possible to drive speakers with more fidelity to the input signals and create a sharp bass sound image with few feeling of noise interference.

NOTE

The speaker cables and sigma servo cables should be distributed along the same paths.

▲CAUTION

- The extension of the negative feedback loop to include the speaker terminals makes it necessary to connect the sigma servo terminals correctly. Incorrect connection may result in sound degradation or other malfunction. If sound is not reproduced normally, check the connection of the sigma servo terminals, etc.
- If the Sigma servo terminals are not connected, the sound may fluctuate or noise may occur. Be sure to connect the Sigma servo terminals correctly.
- When connecting speakers in a parallel configuration, use speakers with an impedance of 4 ohms or more. Connecting speakers with smaller impedance than 4 ohms will cause malfunction.
- The rated input of the speakers connected to this unit should be no less than the maximum output of the amplifier. Otherwise malfunction may result. Be specially careful in this when connecting speakers in a parallel configuration.

■ Basic sigma servo connection

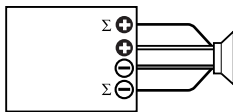

■ Series connection

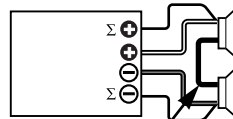

▲CAUTION

Make this cable as short as possible.

■ Parallel connection (1)

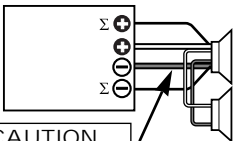

▲CAUTION

The speaker cables connected to this unit should be thick enough to supply the current capacity of two speakers.

■ Parallel connection (2)

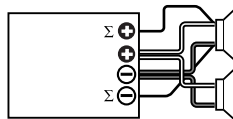

▲CAUTION

This connection is possible only when the speakers are identical and the speaker cables are also of the same type and length.

■ Simplified sigma servo connection

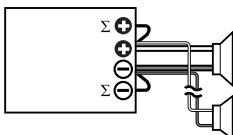

In case any of the connection examples above cannot be used or if the speakers cannot be connected to the speaker terminals, connect them to this unit as shown in the figure.

Troubleshooting Guide

What might appear to be a malfunction in your unit may just be the result of slight misoperation or miswiring. Before calling service, first check the following table for possible problems.

PROBLEM	POSSIBLE CAUSE	SOLUTION
No sound. (No sound from one side.)	<ul style="list-style-type: none"> • Input (or output) cables are disconnected. • The connection of the sigma servo terminals is wrong. • Protection circuit may be activated. • The fuse may be blown because the volume was too high. 	<ul style="list-style-type: none"> • Connect the input (or output) cables. • Check the connection referring to "Sigma servo feed back". • Check connections by referring to "Power indicator". • Replace the fuse with a new fuse and use a lower volume.
The output level is too small (or too large).	The input sensitivity adjusting control is not set to the correct position.	Adjust the control correctly referring to "Controls".
The sound quality is bad. (The sound is distorted.)	<ul style="list-style-type: none"> • The speakers cable are connected with wrong \oplus / \ominus polarity. • A speaker cable is pinched by a screw in the car body. • The switches may be set improperly. 	<ul style="list-style-type: none"> • Connect them properly checking the \oplus / \ominus of the terminals and cables well. • Connect the speaker cable again so that it is not pinched by anything. • Set switches properly by referring to "Controls".

Specifications

Specifications subject to change without notice.

Audio Section

Max Power Output (2 Ω)	400 W \times 1
Rated Power Output (4 Ω)	200 W \times 1 (DIN45324, +B=14.4 V)
(2 Ω)	300 W \times 1 (100 Hz, 0.8 % THD)
Frequency Response (+0, -1 dB)	5 Hz ~ 200 Hz
Total Harmonic Distortion (Rated power)*	0.01 % (100 Hz)
Sensitivity (MAX) (rated output)	0.2 V
Sensitivity (MIN) (rated output)	5.0 V
Signal to Noise Ratio	100 dB
Input Impedance	10 k Ω
Damping Factor	More than 9900 (at Σ connect)
Low Pass Filter Frequency (24 dB/oct.)	50 ~ 200 Hz (variable)
Infrasonic Filter Frequency (24 dB/oct.)	15 / 25 Hz

Sensitivity = Mini. , Through LPF (30 kHz)

General

Operating Voltage	14.4 V (11 ~ 16 V allowable)
Current Consumption (4 Ω , 14.4 V, 10% THD)	28 A
Dimensions (W \times H \times D)	290 \times 52 \times 250 mm
Weight	3.1 kg