

**COLOUR
TELEVISION**

**26" LCD TV
GULCD26HDIT**

ENGLISH

GRUNDIG

BOX CONTENTS:

26" LCD TELEVISION
REMOTE CONTROL
WARRANTY CARD
INSTRUCTION BOOKLET
BATTERY x 2
3 YEARS INSURANCE PLAN



CONTENTS

MAINS OPERATION	.5
SAFETY INFORMATION	.6
WHAT ARE THE FUNCTIONS OF YOUR TV SET	.9
REMOTE CONTROL	.10
ANTENNA CONNECTION	.12
VIDEO, COMPUTER AND DECODER CONNECTION	.13
CONNECTION TO EXTERNAL EQUIPMENT	.14
CONNECTION TO EXTERNAL EQUIPMENT (PC AND HDMI)	.15
SWITCHING ON AND OFF	.16
TV FUNCTIONS	.17
TV FUNCTIONS (MENUS)	.19
TELETEXT	.30
DVB SECTION	.32
REMOTE CONTROL (DVB FUNCTIONS)	.33
SETUP	.34
INSTALLATION	.37
INPUT CONTROL/EPG	.39
DVB DIGITAL TELETEXT - MHEG 5 / TV MENU	.40
TROUBLESHOOTING	.41
TECHNICAL SPECIFICATIONS	.43

MAINS OPERATION

MAINS SUPPLY 230- 240 V ~ 50 Hz MAINS PLUG

1. Two-Wire Power/Mains Lead Label

IMPORTANT

The wires in the mains lead are coloured in accordance with the following code:

Blue - Neutral

Brown - Live

As the colours in the mains lead of this

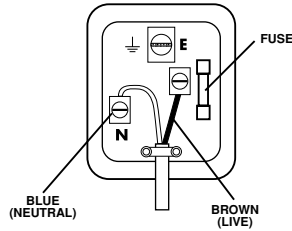

appliance may not correspond with the coloured markings identifying the terminals in your plug, proceed as follows:

No connection is to be made to the Earth terminal of the plug.

The wire which is coloured blue or black must be connected to the terminal which is marked with the letter N or coloured black.

The wire which is coloured brown or red must be connected to the terminal which is marked with the letter L or coloured red.

If a 13 Amp (BS 1363) Plug is used, fit an ASTA approved 3, 5, or 13 amp fuse as required.

If your product is fitted with a moulded plug which requires replacement please cut off and dispose of safely, then rewire as shown above.

2. Three-Wire Power/Mains Lead Label

IMPORTANT

The wires in the mains lead are coloured in accordance with the following code:

Blue - Neutral

Brown - Live

Yellow/Green - Earth

As the colours in the mains lead of this

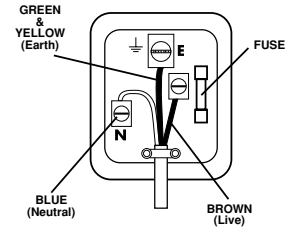

appliance may not correspond with the coloured markings identifying the terminals in your plug, proceed as follows:

The wire which is coloured green and yellow must be connected to the terminal which is marked with the letter E, or by the earth symbol, or coloured green or green and yellow.

The wire which is coloured blue or black must be connected to the terminal which is marked with the letter N or coloured Black

The wire which is coloured brown or Red must be connected to the terminal which is marked with the letter L or coloured Red..

If a 13 Amp (BS 1363) Plug is used, fit an ASTA approved 3, 5, or 13 amp fuse as required.

If your product is fitted with a moulded plug which requires replacement please cut off and dispose of safely, then rewire as shown above.

SAFETY INFORMATION

Mains supply

This unit is designed to operate from a 230 Volt, 50Hz AC mains supply. Other power sources may damage it. Check that the rating on the back of the unit says 230V AC (~) before you plug it in for the first time.

Mains plug

We have fitted this unit with a standard mains plug.

- If the mains lead gets damaged it must be replaced by a qualified service agent with an approved lead of the same type.
- If you cut off the mains plug, for example to fit a different type, please destroy the old plug as it would be dangerous if inserted into a live power outlet. Carefully follow the wiring instructions supplied with the new plug.
- Remove the fuse from UK standard (BS 1363) plugs before disposal.
- Never use a mains plug without the fuse cover.

Mains plug wiring for the UK

- The colours of the wires in the mains lead of this unit may not match the coloured markings of the mains plug terminals. You can identify the correct terminals as follows.
- The wire that is coloured BROWN is connected to the terminal that is marked with the letter L or coloured red.
- The wire that is coloured BLUE is connected to the terminal that is marked with the letter N or coloured black.
- Make sure the lead is firmly secured under the cord clamp.
- Do not connect anything to the earth terminal which is marked E or \perp or coloured green or green and yellow.

Mains fuse for the UK

UK standard (BS 1363) plugs must have a 3 amp (BS 1362 type) fuse fitted. For any other type of plug or connection, you must fit a fuse rated between 3 and 5 amps in the mains plug or adapter, or at the fuse box feeding this unit.

Symbols



This unit is double insulated and an earth connection is not required



This unit complies with European safety and electrical interference directives.



Dangerous voltage constituting a risk of electric shock is present inside this unit.



There are important operating and maintenance instructions in the literature accompanying this unit.

WHAT TO DO FOR SAFETY OF YOUR TV SET



POWER SOURCE

You should only plug this TV into a 230-240V AC 50Hz mains supply.

MAINS AND OTHER LEADS

Position the mains supply lead and other leads so that they are not likely to be walked on, pinched by things or placed on or against them. Pay particular attention to leads where they enter a power socket and at the point where they come out of the TV.

MOISTURE AND WATER

Do not use the TV in a humid or damp area. The equipment must not be exposed to dripping or splashing, as this may be extremely dangerous. Objects filled with liquids, such as vases, must not be placed on this equipment.

NO NAKED FLAMES

Do not place naked flame sources such as lighted candles on top of the TV set.

CLEANING

Always unplug the TV before cleaning it. Do not use liquid or aerosol cleaners. Clean your TV with a soft damp cloth.

BATTERY DISPOSAL

You must dispose of the battery within the IR remote control in accordance with your national law requirements. Some countries prohibit the disposal of batteries with household waste.

CAUTION: TO REDUCE THE RISK OF ELECTRIC SHOCK DO NOT REMOVE COVER (OR BACK). NO USER-SERVICEABLE PARTS INSIDE. REFER SERVICING TO QUALIFIED PERSONNEL.

VENTILATION

The slots and openings on the TV are for ventilation. Please ensure that there is enough space to allow for adequate ventilation around the TV (at least 10cm).

Do not block or cover these holes as overheating could occur.

CLIMATE

The intended environment of the TV set is detailed below. Do not exceed these limits otherwise a Electric Shock Hazard may exist.

Temperature- 15 - 35°

Relative Humidity- 75% maximum

Climate Classification Moderate

Also under specification for the Sound output should be 2 x 7W.

REPLACEMENT PARTS

The person carrying out the job must use parts that are specified by the manufacturer or have the same specifications as the original parts. The use of other parts may cause fire, electric shock or other hazards.

SERVICING

Ensure the person carrying out repairs to your TV is qualified to do so. **Please refer to separate service information supplied with this product.** Never remove the cover yourself, there are dangerous voltages inside and you could receive an electric shock.

SAFETY INFORMATION (continued)

GENERAL

- Do not connect or adjust cables while the TV is plugged into the mains supply.
- Do not leave your TV in a hot, cold or humid area.
- Batteries in remote handsets can leak. Please check the batteries regularly if they have not been replaced recently
- Never let anyone, especially children, push objects into holes and ventilation slots.
- Don't continue to use your unit if you have spilt liquids in it, if it is damaged in any way or if it does not work normally. Immediately unplug the unit and get expert advice.
- This product is only designed for household or similar general use. Any other use may invalidate the guarantee and might be dangerous.
- We are proud to offer this high quality product. To keep this equipment at this level of quality, this equipment should only be serviced at your authorised service centre.

WHAT ARE THE FUNCTIONS OF YOUR TV SET

Front

2. Remote control receiver and LED display
3. Speaker
4. TV + / TV – Program up and down buttons
5. V+ / V – Audio up and down buttons
6. MENU button
7. AV selector button
8. Standby button
9. Side AV in / Headphone in

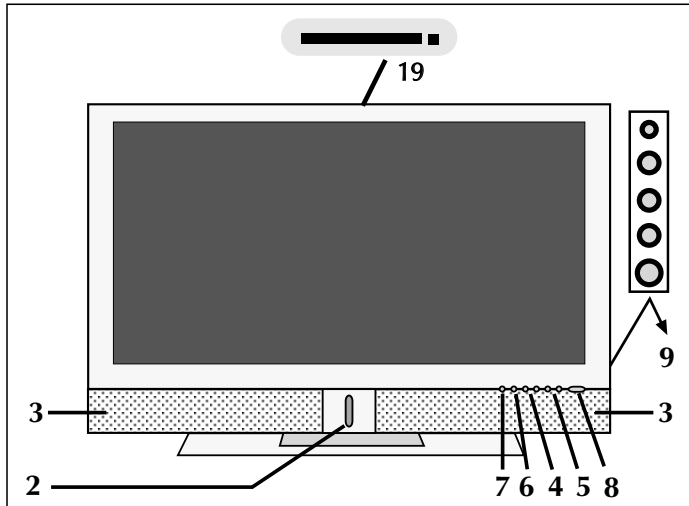

Rear

1. ON/OFF switch
10. Aerial in
11. SCART connectors. (For connecting DVD, Video, Set Top Boxes and similar equipment.)
12. S-VIDEO and S-AUDIO in
13. YPbPr in
14. YPbPr Audio in
15. PC in (Optional)
16. PC Audio in
17. HDMI in (Optional)
18. AV out (For Video and Audio transmission)
19. CI Common Interface

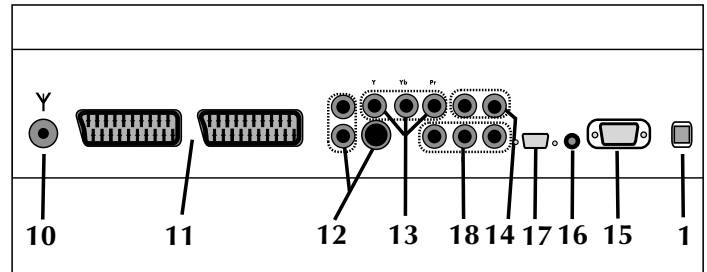

REMOTE CONTROL

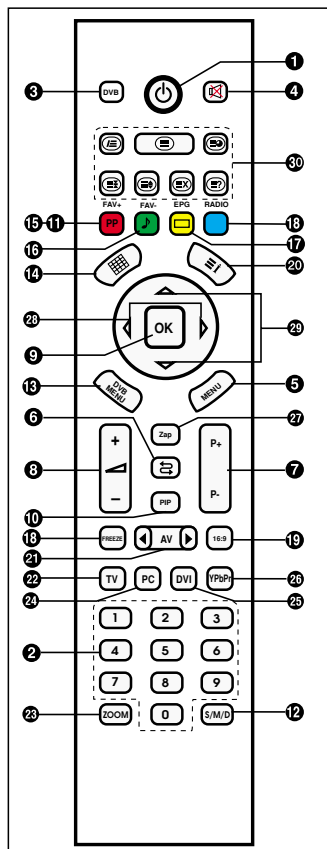

1. Stand-by button: Switches the set on from Stand-by or off to Stand-by.
2. Direct program selection buttons
3. DVB button: Switches between TV and DVB
4. Mute button
5. TV Menu selection button
6. Swap button
7. Upward (P+) or downward (P-) move of program in TV mode, or of page number in teletext mode, upward (P+).
8. Volume increasing (V+) or reducing (V-).
9. OK button: Accepts your selection, Brings the channel list up in DVB mode
10. PIP button **(At some models)**
11. User normalization button
12. Sound select button DUAL I, DUAL II, Stereo, Mono (DUAL I, II, ST/MONO)
13. DVB menu selection button
14. Mosaic Screen button (at some models) and back button in DVB mode.
15. Red button (To change PIP dimension) (at some models)
16. Green button (To change PIP position and to select sound preference (at some models)
17. Yellow button (To enter TV mode while in Teletext mode and to select picture preference). (at some models)
18. Blue / Freeze button (Only available in TV mode)
19. Picture format selection
20. Press once for the now / next info in DVB mode, second press displays current programme information
21. AV button (to scroll through all available source on TV)
22. TV button: To go back to TV mode from PC, YPbPr **(At some models)** and DVI modes.
23. ZOOM button (at some models)
24. PC button: To enter PC mode.
25. DVI button: To enter DVI mode.
26. YPbPr button: To enter YPbPr mode. **(At some models)**
27. Zap button (at some models)
28. ◀/▶ buttons: Changer or adjust items in the menus
29. ▲/▼ buttons: Up (▲) or down (▼) movements in the menus
30. Teletext buttons

REMOTE CONTROL



Never drop your Remote Control.

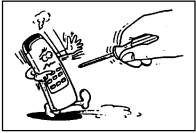

Do not attempt to open your Remote Control.



Do not press any 2 buttons on Remote Control simultaneously.

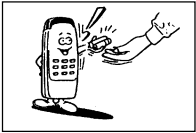

If you do not plan to use your Remote Control for a long time, remove the batteries.

Note : The Remote Control will operate the TV up to 7 metre a way and at an angle of 30 degrees.

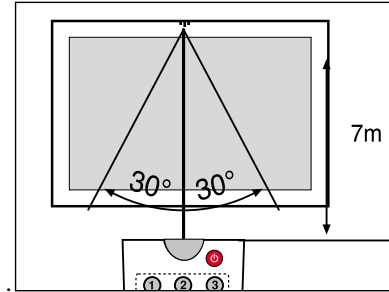

BATTERY INSERTION (1,5V AAA x 2 pieces)

- Remove battery cover



- Place the batteries properly.

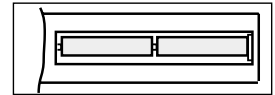

- Close the cover.

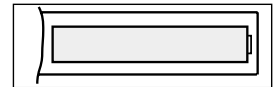

AERIAL CONNECTION

Aerial Connection.....

First select the antenna. The following antennas are suitable for your TV set.

- * VHF antenna
- * VHF / UHF combined antenna
- * UHF antenna

When connecting one of these aerial to your TV set, you should use 75 Ohm round "coaxial" cable and unplug your TV set



Plug the external aerial in the aerial socket as show oposite. An indoor aerial is not recommended. As motor vehicles emulate energy and communication lines emulate noise signals, please take care to install your antenna far from these and metal surfaces. Do not extend your aerial cable longer than required or roll it. As the aerial and cable may be impaired by prolonged exposure to rain, wind and smoke, we recommend that they are periodically checked by a professional aerial fitter. A poor aerial or cable often results by a "snowy" picture.

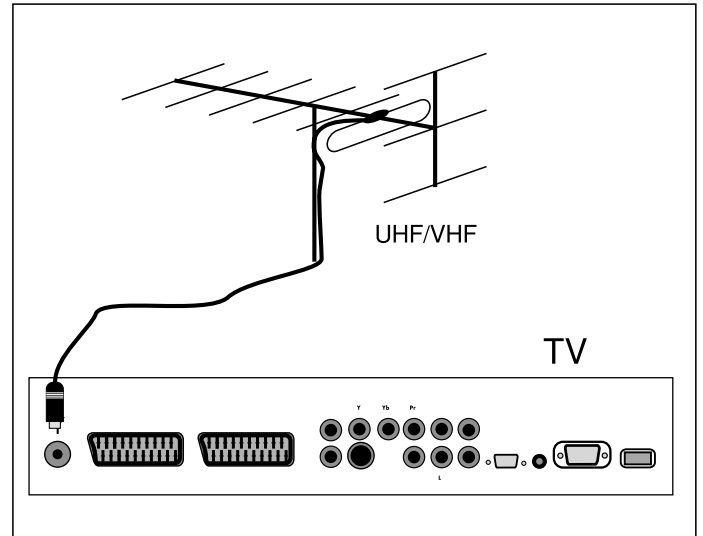

VIDEO AND DECODER CONNECTIONS

1. Video tape connection (through coaxial cable)

- * Connect antenna cable plug into the antenna input of your video cassette equipment. (This is typically marked RF in)
 - * Connect the RF output of your cassette equipment to the antenna input of your TV set. You must use co-axial cable for this.
 - * Insert a video cassette and press play.
 - * Choose the channel to be used to view your video cassette equipments output.
- Note:** If the display or volume are impaired, take the video tape away from the TV set

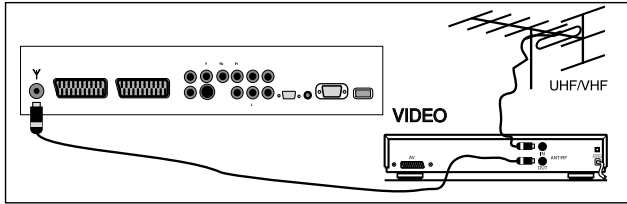

2. Video tape connection (through scart cable)

- * Connect the antenna cable plug into the antenna inlet of the video set
- * Connect the SCART socket of the video tape and scart socket of the TV set through EURO scart cable
- * Press "AV" button until Scart is selected.

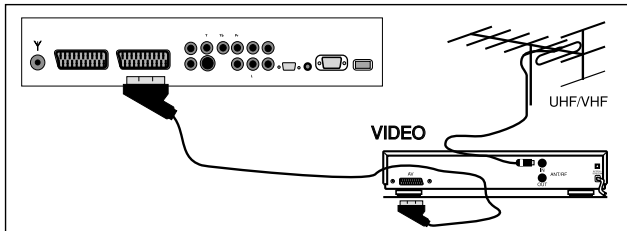

3. Decoder Connection

- * Connect the antenna cable plug to the antenna inlet of the decoder
- * Connect the antenna outlet of the Decoder (RF outlet) to the antenna inlet of the TV set through coaxial cable
- * Ensure the decoder is switched on.

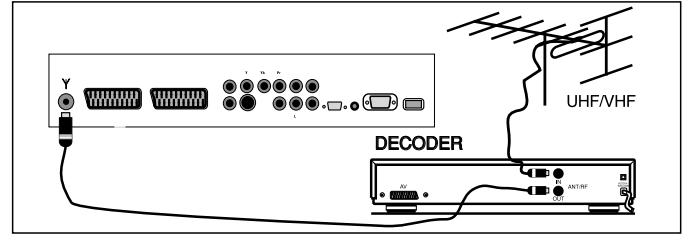

4. Decoder Connection (through scart cable)

- * Connect the antenna plug to the antenna inlet of the TV set
- * Connect the scart socket of the decoder to the scart socket of the TV set through EURO scart cable
- * Press "AV" button until scart is selected.

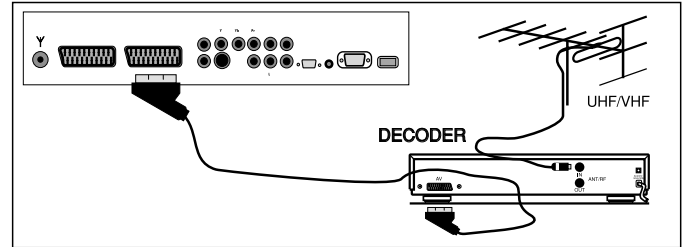

CONNECTION TO EXTERNAL DEVICES

5. Receiver connection (Satellite Receiver)

Connect the cable from the satellite dish to the “LNB-IN” inlet of the Satellite Receiver.

a. With Scart Socket

* Connect the Satellite Receiver’s scart socket and your TV’s scart socket using EURO scart cable.

* Press the “AV” button until scart is selected.

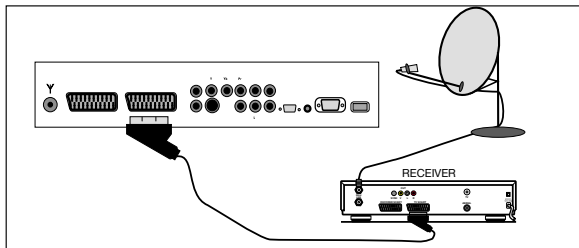

b. Connecting from the side AV Inlets (Optional)

* Connect the chinch sockets on the Receiver or Camera (Video, Left Audio, Right Audio) to the sockets to the side of the TV

* Press the “AV” button on the RC until the Side AV position is selected.

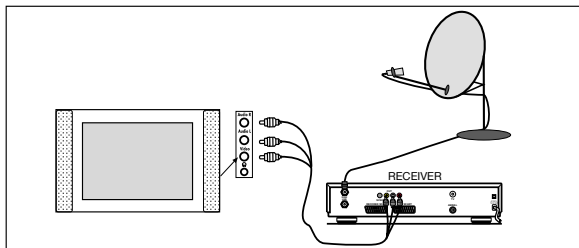

c. With SVHS Socket

* Connect the SVHS socket of the Receiver and that of your TV set, through the SVHS cable. This provides a display transmission

* For the volume, connect the Receiver’s (L, R) Left and Right chinch volume outlets to the (L,R) Left and Right inlets of the TV using double sided chinch socket cable.

While the Receiver is on, press the AV button of the TV set until the Receiver Display comes to the screen.

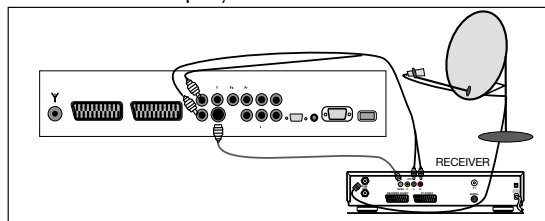

d) AV Out (Not available in some models)

• Use the AV outlets on the TV (Video, Left Audio, Right Audio) to transmit the video and audio of the TV set to another equipment.

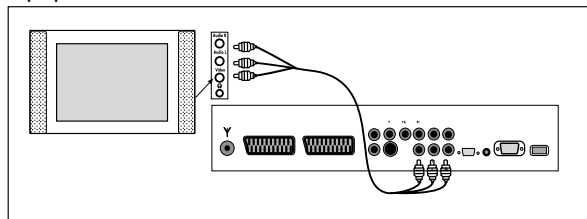

CONNECTION TO EXTERNAL DEVICES (PCI AND HDMI)

e) Component YPbPr In

*Video: Connect the DVD YPbPr sockets to the TV YPbPr connectors using a 3 way AV cable.

* Sound: Connect the left and right (L,R) sound output connectors on the DVD to the left and right sound input connectors on the TV using AV cables.

Press the AV button on the TV RC until the signal from the DVD is selected.

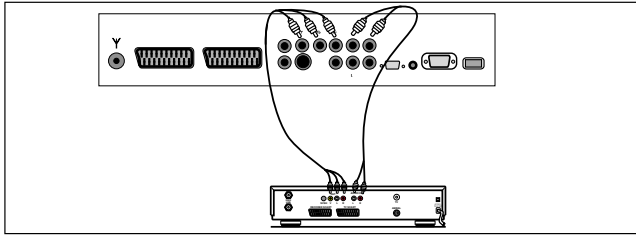

f) Computer Connection (Optional)

To use the TV as a monitor connect the computer VGA (Monitor) output to the TV PC socket. The HDMI socket can also be used.

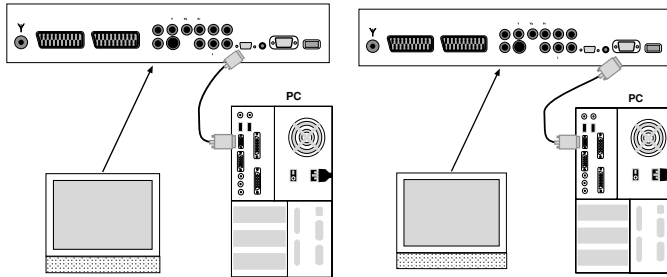

g) DVD Connection (Optional)

The HDMI socket can also be used to connect a DVD to the TV.

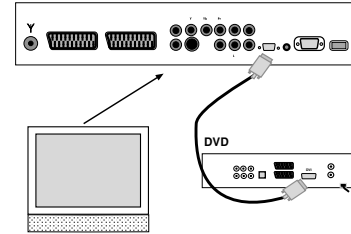

The resolutions which support PC & HDMI

-	VGA	640*480	60 Hz/ 70 Hz/ 75 Hz
-	SVGA	800*600	60 Hz/ 70 Hz/ 75 Hz
-	XGA	1024*768	60 Hz/ 70 Hz/ 75 Hz
-	SXGA	1280*1024	60 Hz/ 70 Hz/ 75 Hz

**HD
ready**

SWITCHING ON AND OFF

Note: RC is an abbreviation for the Remote Control

1. Turning On

a. Turning on the TV

Set the mains switch at the rear of the TV to ON.

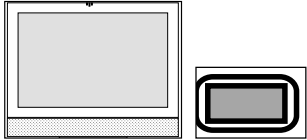

b. STAND BY MODE

Turn on the TV by pressing the  stand by button on the RC, the stand by button on the front of the TV or the TV+/TV- buttons on the TV.

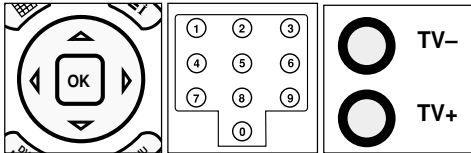

2. Turning Off

a. Turning off the TV

Set the mains switch to OFF.

b. Standby Mode

To turn off the TV for a short time period, press the Standby button on the RC or TV

If you are not going to use the set for a long time, press the ON/OFF button on the TV set.

1. Selecting Program Number

• Using the TV+/- buttons on the TV control panel or RC, you can select any program.

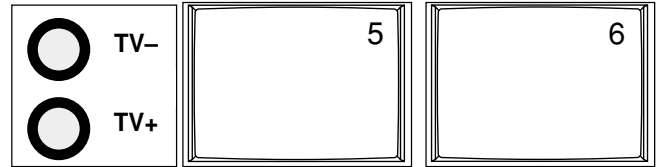

• When you want to select a program between 1 and 9, press the number on the RC

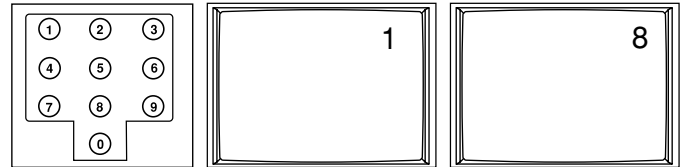

• To select a number between 10 and 99, the program number is pressed on the RC quickly on the RC.

TV FUNCTIONS

Example: To shift to program No. 99, first press 9. In that case a message "9" appears on the right corner of the screen. Quickly press 9 again, the set changes to the program no. 99

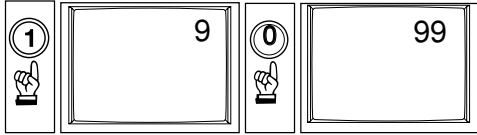

2. MUTE



To mute the sound, press MUTE button on the RC. Pressing this button again will restore the sound at its former level.

3. 16:9 button: This is used to change the picture size. Auto, 16:9, 14:9, Cinema, Zoom and 4:3 picture formats are available.

Manual Zoom: Press the (⊕) Zoom button on the RC while in cinema mode to activate Manual Zoom. Pressing V+/V- buttons will adjust vertical zoom.

4. PP: Pressing this button will load the audio and picture values in the memory. Pressing PP button for about 2 seconds will memorize current TV audio and pictures values as "User Settings" an on-screen message confirms the settings have been stored.

5. S/M/D button: For stereo broadcasting, you can change the volume as Mono, Stereo or DUAL A, DUAL B.

6. AV: To select video source press the AV button on the R/C. Following modes can be selected in source menu "TV, SCART1, SCART2, SIDE AV, S-VIDEO, YPBPR, PC INPUT, HDMI, DVB".

* Source Menu can't be displayed while in PC, DVI modes, so to return back to TV in DVI, PC modes, press (TV) button.

While menu is on the screen, you can't switch the set to AV mode.

7. Automatic shutting down: The TV set will automatically change to stand by mode 5 minutes after the broadcasting is over.

Note: If you leave the TV in AV mode, it will not shift to Standby mode after 5 minutes even there is no broadcasting

8. OK Button: This provides shift from the main menu to submenu vice versa

9. Info Button (i): Press this button to see the information on the current channel

TV FUNCTIONS

 **Swap:** You can return to the previous channel by pressing this.

Note: If there is a menu on the screen, you cannot use it.

 **Mosaic:** This is not functional

Note: Mosaic function is available in some models.

TV FUNCTIONS (MENUS)

Scrolling in the Menu

When you press Menu button, the Main (Display) menu appears on the screen. You can scroll in the main menu options by pressing the left and right arrow buttons on the remote and access to submenus by pressing OK to make changes.

In the submenus, you can scroll up and down the options by pressing the up and down buttons on the remote and select values to change by pressing OK. You can increase or decrease values by pressing the left and right arrow buttons.

1. Installation (Automatic Search, Finding and Memorizing)

Below is the automatic programming procedure for your set. A more detailed explanation on the settings and menus are given in the following pages.

1. Connect your set and switch on
2. Press "Menu" button on the RC
The First (Display Menu) will appear on the screen.
3. Access to "INSTALLATION" menu by pressing the arrow right button.

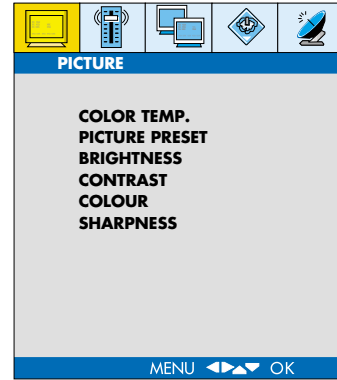

4. Press ► 3 times to move to the INSTALLATION menu. Press OK to access in the menu.

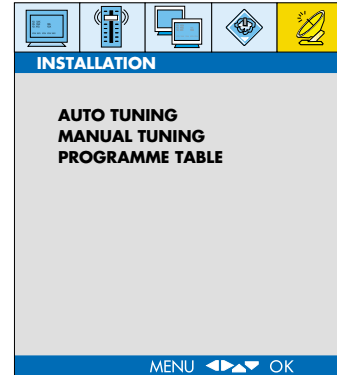

TV FUNCTIONS (MENUS)

5. Press ▼/▲ buttons to access AUTO TUNING option and confirm pressing OK
7. Access the SEARCH option pressing ▼ button

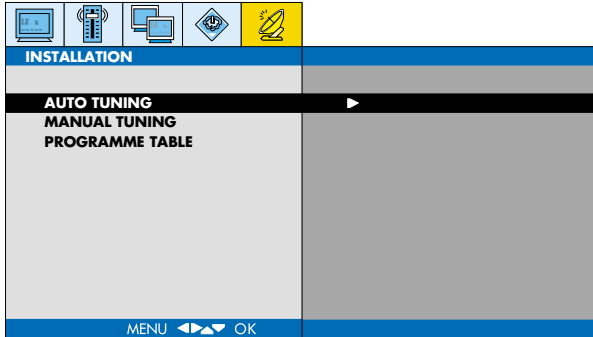

6. Select suitable COUNTRY SELECTION pressing ► button (if your country is not listed, press OTHERS)

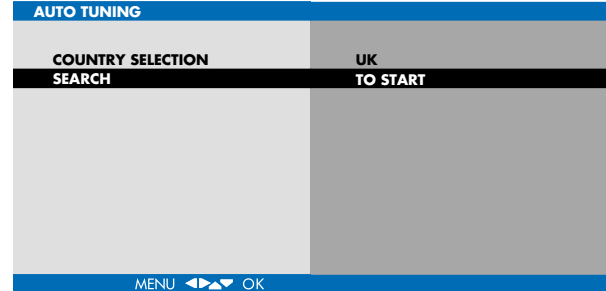
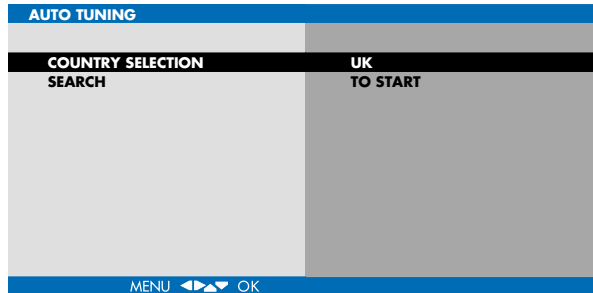

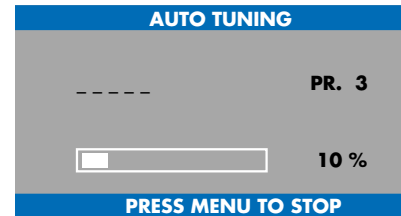

8. Start an AUTO TUNING pressing “►” button. An OSD bar will appear on the screen to show that search has been started.



- Do not do anything until search is complete. Your TV will find and memorize the channels automatically. When the search is over, the PROGRAM TABLE menu will appear on the screen.

TV FUNCTIONS (MENUS)

1 -----	6 -----	11 -----	16 -----
2 -----	7 -----	12 -----	17 -----
3 -----	8 -----	13 -----	18 -----
4 -----	9 -----	14 -----	19 -----
5 -----	10 -----	15 -----	20 -----

 DELETE	 MOVE
 SKIP	OK : SELECT

Naming, program deletion, transfer and channel skip in the “PROGRAM TABLE” are explained in the following pages.

MANUAL TUNING

For a manual setting, you can use the MANUAL TUNING submenu in the “INSTALLATION” menu

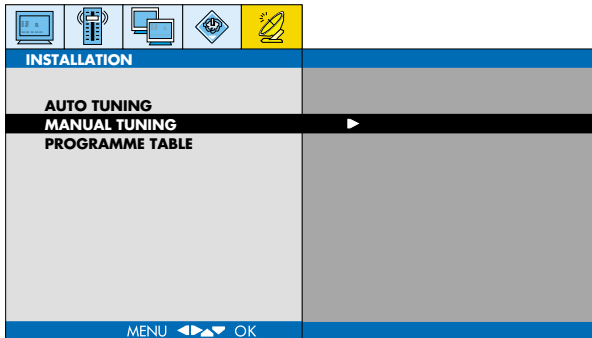

Programme : You can enter the program number to set, using the numerical keyboard on the RC.

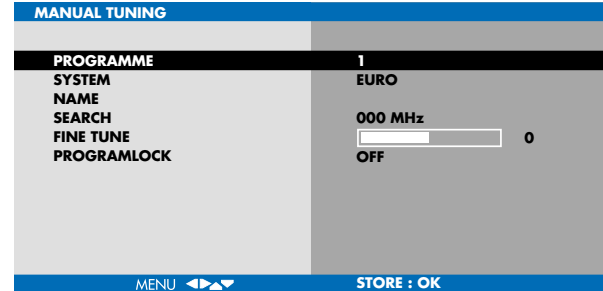

System: You should select FRANCE for France, or EURO for other European countries

Name: You can name the channel. Access to the first digit pressing ► button and find the letter you want to find using ▼/▲ buttons. Repeat the same process until writing fully (5 characters)

Search: You can change the frequency pressing ◀/▶ buttons to find your channel or directly enter the channel number through numerical keyboard.

TV FUNCTIONS (MENUS)

Fine: Press ◀/▶ buttons to fine to the channel you have adjusted.

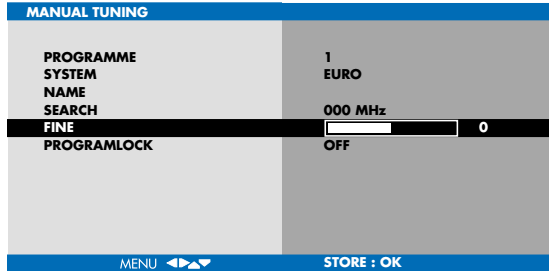

Child Lock: You can turn on or off the channel for which you set a program lock, pressing ▶ button.

Note: You can also access to the locked channels through the RC but you cannot access it using the ▼/▲ buttons on the TV set.



You can memorize the settings in the "Channel Settings" menu pressing OK.

PROGRAMME TABLE

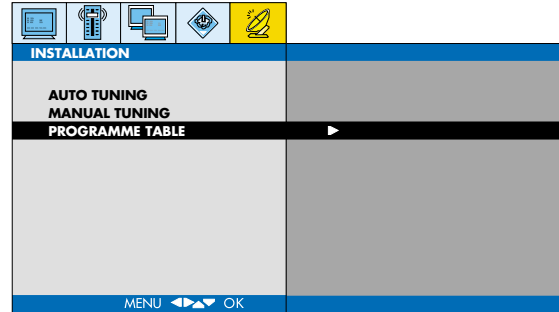

PROGRAMME TABLE			
1 -----	6 -----	11 -----	16 -----
2 -----	7 -----	12 -----	17 -----
3 -----	8 -----	13 -----	18 -----
4 -----	9 -----	14 -----	19 -----
5 -----	10 -----	15 -----	20 -----

● DELETE

● MOVE

● SKIP

OK : SELECT

Delete (Red Button):

While you are on the program which you want to delete, press red button to delete.

TV FUNCTIONS (MENUS)

Move (Green Button):

1. Select the Program you want to move, using the ◀/▶, ▼/▲ buttons
2. Press green button, the program is highlighted.
3. Move the highlighted program to the desired row pressing ◀/▶, ▼/▲ buttons.
4. Press the green button again, move process is over

Skip (Blue Button):

You can select the programs which you do not want to be seen in the channel transitions which take place by ▼/▲ button presses. While the cursor is on the related program, it is sufficient to press the blue button.

OK Button:

While in the Program Table, select the program by pressing OK. Just press OK while you are on the program which you want to be shown in the background.

PICTURE Menu

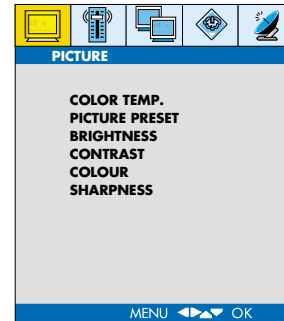

In this menu, you can adjust the picture related parameters.

Color Temperature: You can select the required color value pressing ◀/▶ buttons.

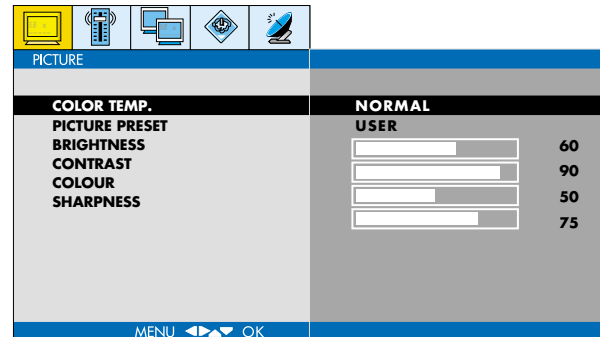

TV FUNCTIONS (MENUS)

Picture Preset: You can select the required picture setting pressing ◀▶ buttons. When you select "User", you can change the below defined settings according to your requirement.

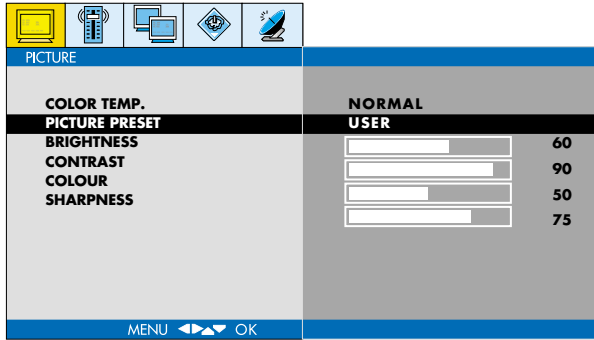

Brightness: You can set suitable Brightness pressing ◀▶ buttons

Contrast: You can set suitable Contrast pressing ◀▶ buttons

Colour: You can adjust suitable Colour value pressing ◀▶

Sharpness: Adjust suitable value pressing ◀▶

SOUND MENU

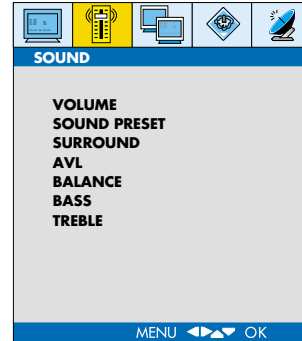

Volume Set suitable sound value pressing ◀▶

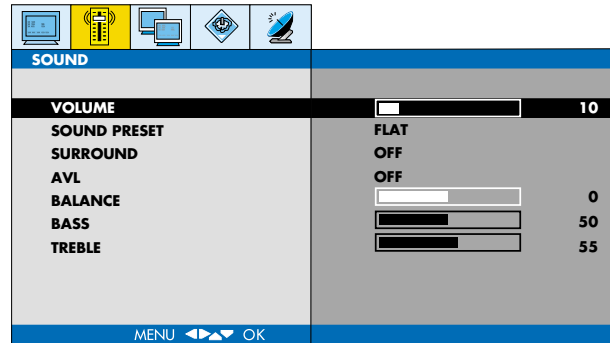

TV FUNCTIONS (MENUS)

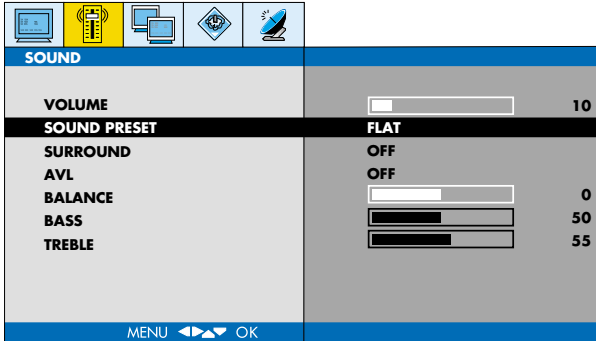

Bass: Adjust "Bass" value pressing ◀▶

Treble: Adjust "Pitch" value pressing ◀▶

Sound Preset: You can select predetermined sound values pressing ◀▶ buttons. Select PERSONAL to set your own values (Bass, High Pitch)

Surround: You can activate or de-activate the surround sound effect pressing ◀▶ buttons

AVL: You can activate or de-activate the AVL feature pressing ◀▶ buttons. AVL keeps the sound level at the same level.

Balance: You can adjust the balance of sound between the left and right speakers using the ◀▶ buttons.

TV FUNCTIONS (MENUS)

FEATURES MENU

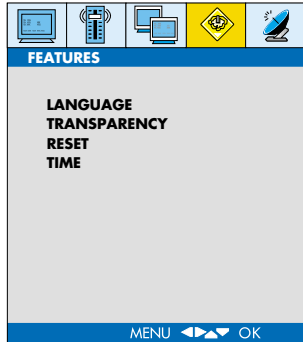

You can use this menu to Features menu and time.

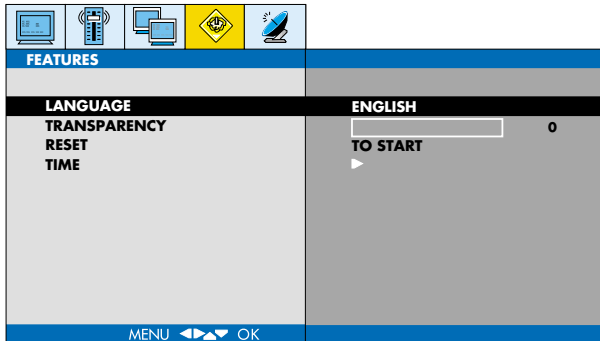

Language: Select the menu language pressing ◀/▶ buttons

Transparency: You can set the menu transparency pressing ◀/▶ buttons

Reset: You can restore the settings to default values pressing ◀/▶ buttons

Time: You can set time and time set program change in the menu.

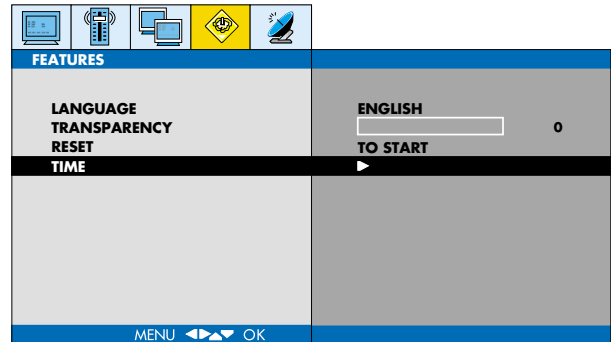

TV FUNCTIONS (MENUS)

Clock: You can enter time data using numerical keyboard

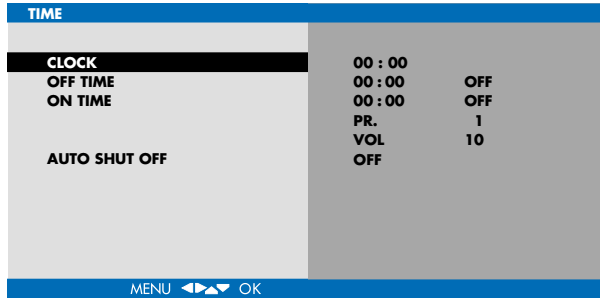

Off time: You can set the time when you want the TV set to switch off. To activate the function, enter the switching off time and access "Off Time" using ► button and turn it to "ON" using ▼ button. The TV set will switch of at the specified time.

On time

While in the Time Menu

1. Press ▼ button to select "On Time"
2. Press ► button and access to time section
3. Enter the time for switching on using numerical buttons
4. Press ► button to select minute section
5. Enter minute using numerical keyboard

6. Press ► button and select On Time to activate using ▼ button
7. Press ► button and enter the number of the channel you want to be switched on
8. Press ► button and enter sound level using numerical keyboard
9. You can return to Features menu pressing OK button

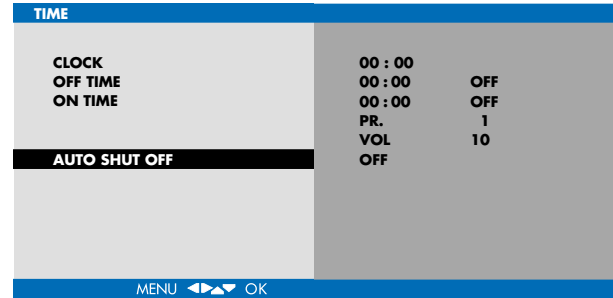

TV FUNCTIONS (MENUS)

All menus appear in the PC and AV Modes. The additional menus in PC monitor use are as follows:

PC Monitor Picture Menu

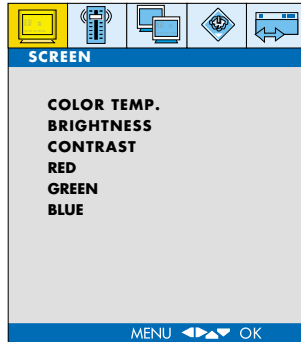

In this menu, there are "Red, Green and Blue" colour options for PC Monitor. You can set the colour values according to your request pressing ◀/▶ buttons.

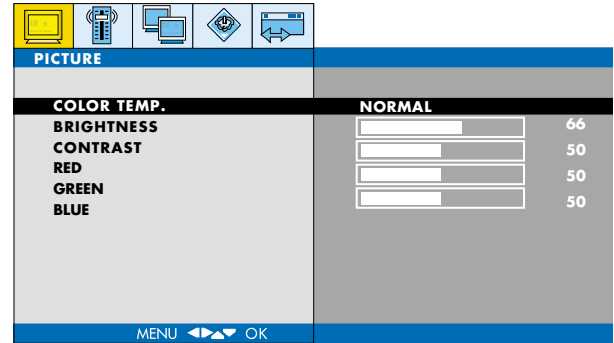

TV FUNCTIONS (MENUS)

PICTURE MENU (This menu is only available when a PC signal is present.)

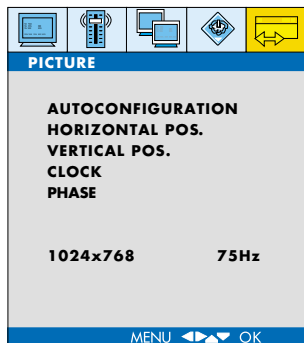

Auto Configuration: On this option, pressing the ► button will automatically carry out the PC monitor settings.

Horizontal position: You can slide the PC display on the screen to right or left horizontally, pressing ◀/▶ buttons.

Vertical position: You can slide the PC display on the screen to up or down vertically, pressing ◀/▶ buttons.

Clock: You can set the time pressing ◀/▶. Changing of this value will provide enlarging or narrowing of the picture on the right side.

Phase: Set the phase pressing ◀/▶ buttons.

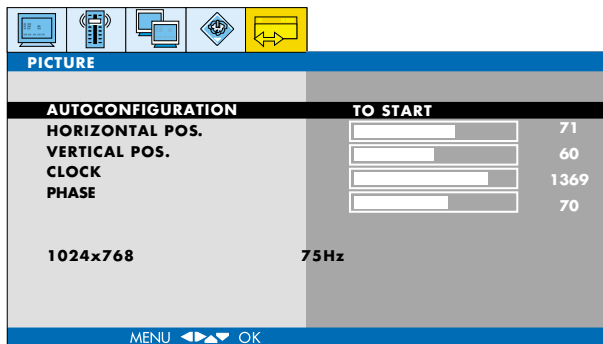

TELETEXT

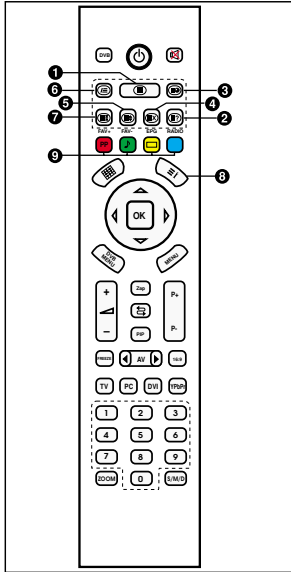



TELETEXT MODE

If the current channel has a teletext broadcast, you can change to teletext mode as described below.

1. Teletext :  Press the teletext button to select teletext. Press again to revert to TV.

1. Teletext button
2. Reveal / Conceal (Reply) button
3. Teletext timer button
4. Cancel (updating) button
5. Size (page enlargement) button
6. Mix (Combined TV and Teletext watching) button
7. Hold (Lower page holding) button
8. Index (Main page) button
9. Color (Red, Green, Yellow, Blue) buttons

2. Reveal / Conceal:  Press the button to reveal answers to quiz or games page. Press again to conceal to answers.

3. Teletext timer:  While watching a TV programme press this button to display the time at the upper right of the screen. The time will be displayed for about 4 seconds. If the program being watched does not have Teletext transmission the time will not be displayed.

4. Cancel:  Pressing this button in the Teletext mode causes the current TV programme to be displayed in some TV models.

But teletext is still active, and if a new page number is entered, page search continues. When the requested page is found, a message showing the page number appears on the screen. Pressing this button again displays the new teletext page.

5. Size :  Press once to display the upper half of the page at double text height. Press again to display the lower half of the page at double text height. Press again to display the full page at normal height.

TELETEXT

6. Mix: (Combined TV and Teletext broadcasting):

Press to superimpose Teletext over the TV programme.
Press again to display the Teletext page alone.

7. Hold:  If a teletext page has subpages, such pages are displayed at certain time intervals. In such a case, press this button to keep a specific page permanently on the screen. When the page is held pressing "HOLD", the Hold icon appears on the upper left corner of the teletext page. Pressing this button again leaves from the hold setting.

8. Index (Main Page):  This button provides direct access to the index page of teletext.

9. Colour Buttons (RED / GREEN / YELLOW / BLUE)

You can easily scan the teletext data by pressing these four coloured text buttons. While this mode is active, pressing MENU button changes colour options and you can access any option of your request easier using the colour buttons

EXAMPLE:

Press RED
button to
receive TV
Guide

Press GREEN
button to
receive sports
information

Press YELLOW
button to
receive news

Press BLUE
button to
receive weather
information



TV GUIDE



SPORTS



NEWS



WEATHER

(The above information are for example purposes, such information may change depending on the selected page)

Fastext

This Tv supports the Fastext system. When a page is requested the system automatically stores the adjacent pages. These can be selected by using P+ to select the next Teletext page and P- to select the previous Teletext page.

Fastext Buttons (Red, Green, Yellow and Blue). Pages related to the current page are also stored in memory can be quickly reached by pressing the appropriate coloured button.

DVB SECTION

- Buttons on TV not available except volume **V+** and **V-** buttons in DVB mode.
- If you are on TV mode, you can enter DVB mode by using DVB button.
- If you press Menu button while you are in DVB mode, only Picture, Sound and Features menu can be seen in the Main menu

REMOTE CONTROL (DVB FUNCTIONS)

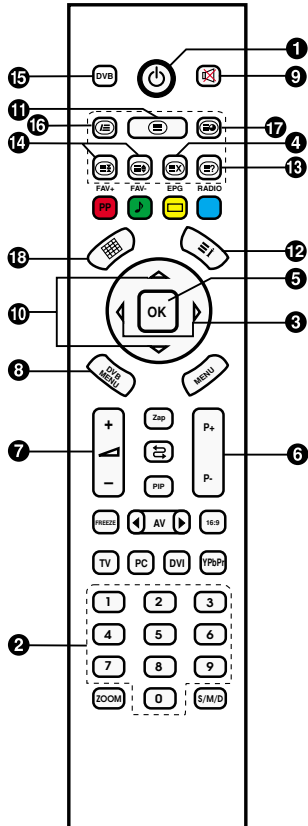

1. STAND BY button

For opening and stand-by operating of the device

2. NUMERICAL KEYPAD (0-9)

For entering the channel (program) number directly or entering numbers

3. ◀/▶ button

Press these buttons to switch to previous or following page while in the channel list. Provides to move in DVB menu.

4. EPG button

To open the EPG menu..

5. OK button (also brings up the channel list screen)

You may access to the commands you want to select in the menus or to the sub-menus using the (MENU) OK button.

6. P+/P- buttons

These change the channel while not in the menu.

7. V+/V- buttons

These buttons are used for adjusting the audio level.

8. DVB MENU button

Press this button to access main menu.

9. MUTE button

For muting the voice.

10. ▼/▲ button

Up (▲) or down (▼) movements in the menus

11. TXT Button

Allows entering or leaving digital teletext when available.

12. Information button

While watching a TV program or listening to a radio channel, the now / next info bar will be displayed when you press  button.

13. RADIO Button

To select Radio and TV mode.

14. FAVORITE +/- Buttons

To switch among the favorite channels.

15. DVB/TV Button

Switches between TV and DVB.

16. Soundtrack Selection

17. Subtitle Selection

18. Mosaic Screen button

This returns you to the previous screen while in the menu.

SETUP

* In order that the settings you have made in the menus be valid, you should confirm them by pressing the green button before exiting.

* You may scroll upwards or downwards within the menus using ▲ and ▼ buttons or access to the sub-menus by pressing.

* You may change values using the numerical keypad and OK button.

For validating the changes, you should press green button before exiting menus. For invalidating them just press the red button.

* To return to previous menu, press  "MOSAIC SCREEN" button and to exit all menus press "DVB MENU" button.

Welcome Menu

During the first pass to DVB mode and everytime when you set as receiver reset the welcome menu will appear on the screen. By using startup wizard function, automatic search could be done for the digital broadcastings. First, you can enter to language menu by using the green button in this menu. In this menu, you can go to requested language option by using ▲/▼ buttons and can select it by pressing OK button. When you select it, TV will automatically start to do channel search. After the channel search completion, TV will enter to first found channel.



1. Setup Menu

Enter into the "Main Menu" by pressing "DVB MENU" button. Select the "Setup" menu in there. You may adjust the Soundtrack, language and clock settings of your device in the Setup menu.

1.1 Soundtrack:

Soundtrack: If there is a different speech language or radio broadcasting on the channel watched, you may change it from this menu.

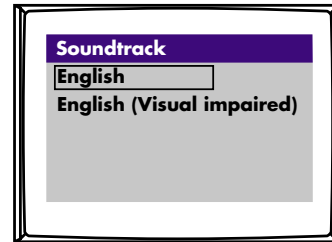
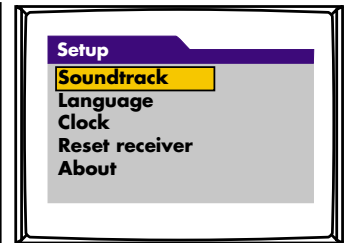
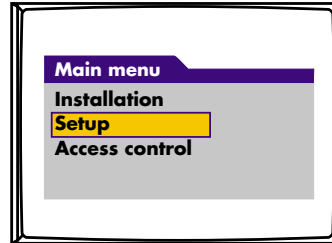

SETUP

You can also reach the soundtrack menu by pressing the Mix  button on the remote control.

You can reach the subtitle menu by pressing the teletext timer  button on the remote control

1.2. Language Selection

Enter into the Language sub-menu from the Setup menu. In this menu;

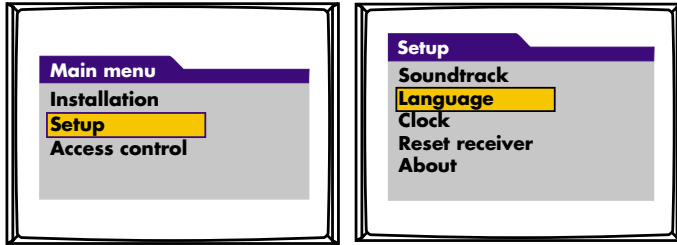

You may set the speech languages if available in the broadcasting (Audio 1, Audio 2) and subtitle languages (Subtitle 1, Subtitle 2)

For making the settings active, exit the menu by pressing the green button.

NOTE: TO CHANGE THE SUBTITLE SERVICE TO DATA SERVICE PRESS THE TEXT TIMER BUTTON AND THEN PRESS THE RED BUTTON TO CHOOSE SERVICE REQUIRED.

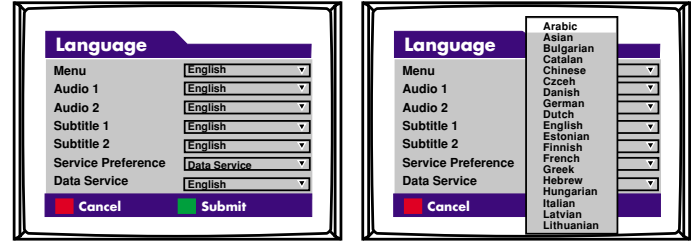

1.3. Clock Menu

Daylight saving: You may enter settings depending on your location being covered by the summer time application or may adjust your device to select automatically based on your digital channel settings.

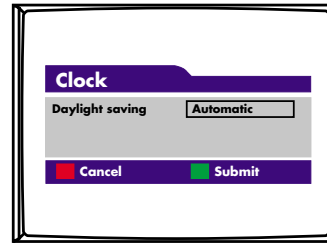

For activating the settings, press green button before exiting the menu.

SETUP

1.4. Reset the Receiver

WARNING!

After resetting, all settings and channels in the memory will be deleted.

When you want to return to manufacturer settings, you may press green button after entering the PIN code in this menu. Your PIN code is 7139.

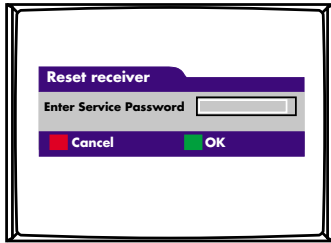

1.5. About

In this menu you can see the software version of your device.

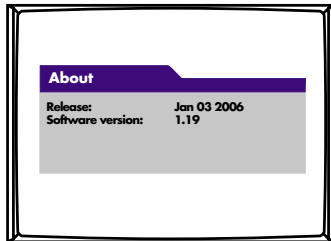

INSTALLATION

2. CHANNEL INSTALLATION

Enter into the “Main Menu” by pressing “DVB/MENU” button. Select the “Installation” menu in there. In this menu you can have digital channels search performed and then, adjust the channels.

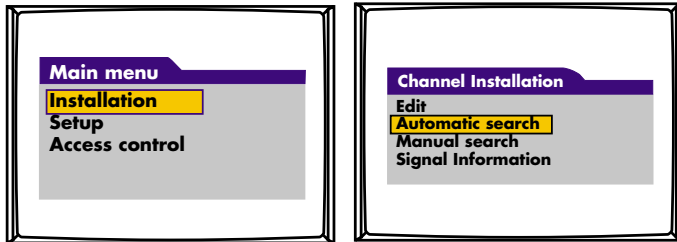

2.1. Automatic search

When search is selected with the OK button. Automatic programming will start directly and add non-existing channels.

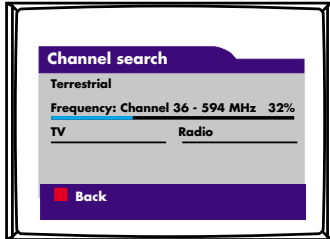

2.2. Manual search

You can do searching according to frequency in manual search menu. Go to the channel line, you may find your requested frequency by pressing on OK button, and after that when you press once more to OK button the requested frequency option would be selected. You can do manual search by using green button.

Programming will start directly and add non-existing channels.

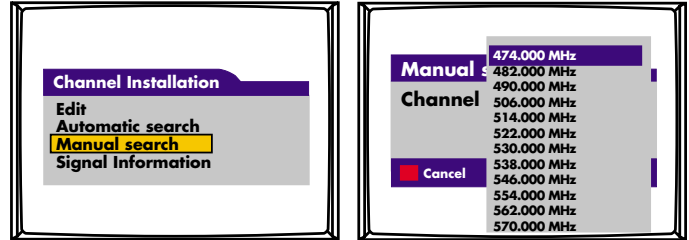

2.3. Edit channels

In this menu, you may delete channels by pressing the red button. You can also determine your favorite channels in this menu.

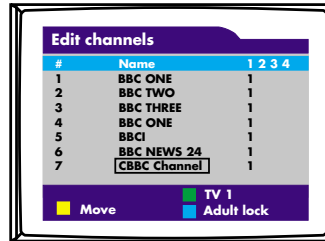

Go to your requested channels and by using 1,2,3,4 number buttons your favorite channels might be arranged in order. When you do this selection as well, you will see the related channels signed with 1,2,3,4 numbers. To cancel one of channel favorite number or to change it, you should press the same number again. Furthermore, you can set the list of favourite channels as you want to see by pressing Green button. By making a selection (TV, TV1, TV2...) here, all channels related on your selected class will be listed.

INSTALLATION

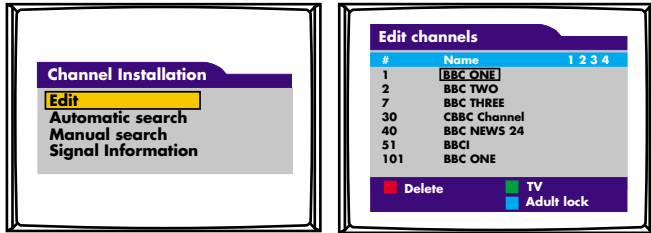

For moving the channels, highlight the channel you want to move and press the yellow button. Then the move shall take place when you select the channel number to move and press the yellow button again.

To exit from this menu press on the "DVB MENU" button.

TV Setup

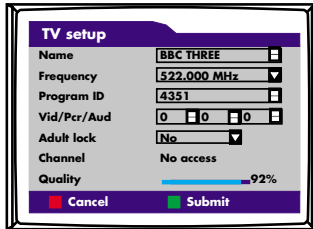

While you are in the "EDIT" menu, the "TV SETUP" menu will be opened when you choose the desired Channel with the OK button.

Name: You can see the channel name and by using the "OK" button you can change the name of TV's channel.

You can select the characters with **◀/▶** or **▼/▲** buttons.

The desired characters can be written with the confirmation of "OK" button.

You can see the colored buttons functions for this menu below:
Red button: Lead the cursor to the left.

Green button: Lead the cursor to the right.

Yellow button: You can choose the letters (small or capital).

Blue button: You can erase the characters.

After you have finished the naming operation, come to the "OK" option at the Menu and confirm with the "OK" button.

Note: You can only name the channels which don't have names. Changing names of channels which have original names, can not be memorised.

Frequency: You can change the channel's frequency by using the "OK" button.

Program ID: You can make changes by using numeric buttons.

Vid/Pcr/Aud : This is the Video and Audio ID number of the TV channel which is broadcasted on the stream and you can make changes by using numeric buttons.

Adult lock: The channel will be locked and hided by selecting this option as "YES". You have to activate "Adult Lock" option from the "Access Control" menu for operating this function. Which is explained in following pages.

Channel: You can see the information of signal.

Quality : You can see the quality of signal.

Signal Information: You can see the channel's and channel's signal informations

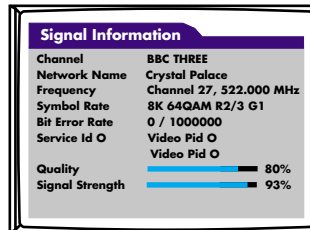

INPUT CONTROL / EPG

3. Access Control (At some models)

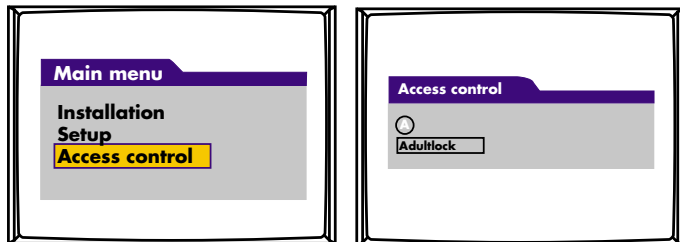

In this menu, you may activate the lock function. Press OK while the Access control is on. In the menu appearing on the screen, activate the “Adult lock” option.

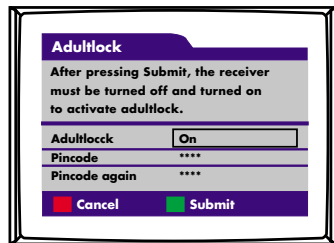

Enter the 4 digit PIN code into the “PIN Code” and “PIN Code repeat” lines. Exit the menu pressing the green button. When you shut down and reactivate the device, the Parental Lock will become active. When you want to enter into the main menu, you should enter the PIN code.

To cancel the parental lock, set the “Parental Lock” off.

Module: The A option is activated when a CI module is installed in the CI slot. You can reach the CI Module information by pressing OK when the A option is highlighted. Please turn off and on the TV set after the CI module is installed.

4. EPG

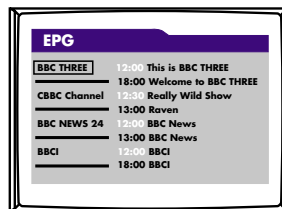

If the broadcasting you watch contains EPG (electronic program guide) information, you can see this by pressing the EPG button. At this menu you can find the channels present and following broadcast informations. With the ▲/▼ buttons choose your desired channel at Program guide and press "OK" button. After choosing process (if your broadcast provider supports) you can reach the relevant listed weekly channel's broadcast information daily.

By pressing ◀ / ▶ buttons you can reach the preceding and following pages and can see the other days information. You can see the detailed informations of your desired program by using ▲/▼ buttons and pressing OK button afterwards.

By pressing ◀ / ▶ buttons you can reach the preceding and following EPG information's of the program. For returning the preceding menu press  Mozaic button.

DVB DIGITAL TELETEXT - MHEG 5 / TV MENU

If the broadcasting you watch has a Digital Teletext - MHEG 5 Feature, you can perform various actions in the teletext mode using the buttons defined below:

5. TXT : Provides access to or exit from the Digital teletext mode. For reaching Digital Teletext pages enter the pages numbers with numeric buttons and press OK button. Besides with ▲/▼ buttons you can pass through the relevant page by choosing your desired headline among the others. For more than one subject crossing among pages is possible with ▲/▼. You can pass through the following or preceding headlines with ◀/▶ buttons. You can see the TV broadcast completely on the screen by pressing "0" numeric button while screening Digital teletext - MHEG 5 informations.

If you press the same button again you can return your last process. In addition you can reach relevant pages by using colorful (Red/ Green / Yellow / Blue) shortcut buttons which are located below the TXT pages.



TV MENU

You can reach this menu by pressing the information button  and see all of the channels listed. Use direction buttons for your desired buttons and cross the channel with "OK" button. In addition other processes which can be done are explained below :

Red Button : Provides to choose the listed channels as radio or TV.

Yellow Button: You can reach the alphabetical or numeric adjustments option by using this button. You can confirm one of these options by pressing "OK" button with the help of ▲/▼ buttons. Channels will be listed according to your selection.

Green Button : You can provide to list the channels as "ALL" or "ONLY FREE" by pressing this button.

Blue Button : You can list your favorite channels which were determined at Edit menu. (TV, TV1, TV2...)

Exit this menu by pressing Mozaic button.

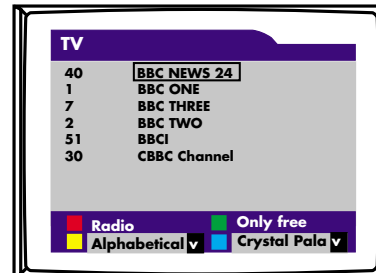

TROUBLESHOOTING

Caution:

When the TV set is operated at ambient temperatures of 5 degree Celsius or lower, there will be a focus disorder and colorization problem (pink) at the first switching on. Your set provides normal display in 10 to 15 minutes. Operating the set in such adverse ambient conditions will reduce its life. So, do not operate it at low ambient temperatures (5 degree Celsius or lower).

Please check these simple things before requesting service. A couple of minutes spent here may cure your problem.

SYMPTOM

- No Power – Check that your TV is connected to the mains supply and the outlet is switched on. Ensure the TV power button is in the ON position.
If the TV is in Standby mode (the red light will be ON at the front of the set), bring it out of standby by using the P+ or P- buttons on the remote handset or on the front of the TV.
- No Sound – Ensure that the TV is not in MUTE status. A  is displayed on screen while the TV is in MUTE status.
Turn up the TV volume if it is set to or near minimum.
- Weak Picture – Adjust the picture control settings.
Try to avoid facing the TV towards light sources such as windows as this will wash out the picture.
- Poor Colour – Check the colour setting in the picture control settings.
Try fine tuning the station.
- Corrupt Teletext – Teletext requires a good signal from the aerial. Please check the aerial connection on another TV. An outdoor aerial is recommended. Try fine tuning the station.
- Colour Distortion – Devices such as loudspeakers, sub woofers etc contain strong magnetic fields. If you experience colour distortion along the edges or in the corners of the screen you should turn the TV OFF at the mains and leave to stand for 20 minutes. When the power is re-applied, the degaussing circuit will try and restore the magnetic balance with the tube. If this distortion does not clear up after degaussing, the magnetic source must be moved away from the TV so that it causes no colour distortion.

TROUBLESHOOTING

Problem

You sometimes see a squared pattern on the screen, your picture is “Freezing” or a picture showing a TV with a noisy pattern.

Possible cause

There could be a transmission problem.

Your aerial may have been moved, for example by severe weather. Your aerial connection have become loose or disconnected.

Action

This is a normally only a temporary situation and should correct itself. If it persists, contact ITV Digital customer channels. Check signal quality and if necessary re-align your aerial. Check all aerial connections and make sure they are all firmly pushed into sockets.

TECHNICAL SPECIFICATIONS

Screen size	26"
Standard nominal value (cm)	94 cm
Power consumption (Watt)	160 W
Operating voltage	230 V (AC) 50 Hz
TV System	MULTI SYSTEM / NTSC PLAYBACK
Channel Band	VHF I Channel 2-4 VHF III Channel 5-12 UHF Channel 21 - 69 S Channel S1 - S41
Antenna inlet	75 Ohm standard aerial socket
Program capacity	99 + AV
Picture Panel	TFT LCD Panel 1366 x 768 resolution
Audio output (rms 10% THD)	2 x 8 W

DVB SECTION

Video decoding

- MPEG-2 DVB compliant up to MP@ML
- Video bit rate: up to 15 Mbit/sec

Reception-Demodulation

- Demodulation type: COFDM 2K/8K
- NETWORK: MFN/SFN
- Input frequency range : UHF IV / V
- Loophthrough frequency range (MHZ): 47 - 862 MHz

CAUTION

There might be incompatibilities between this manual and the set.
Manufacturer Company reserves its right to alter specifications of its products.

MODEL NO: GRUNDIG GULCD26HDIT

