

Canon EF LENS

EF200mm f/2L IS USM



IMAGE STABILIZER
ULTRASONIC

ENG
Instruction

Thank you for purchasing a Canon product.

Dedicated to EOS cameras, the EF200mm f/2L IS USM is a high-performance telephoto lens equipped with an Image Stabilizer.

- "IS" stands for Image Stabilizer.
- "USM" stands for Ultrasonic Motor.

Features

1. The Image Stabilizer gives the equivalent effect of a shutter speed five stops faster*. The lens also has a second image stabilizer mode that is optimized for following shots of moving subjects.
2. With fluorite and UD lens elements, outstanding image delineation is obtained.
3. Ultrasonic motor (USM) for quick and quiet autofocus.
4. Manual focusing is available after the subject comes into focus in autofocus mode (ONE SHOT AF).
5. The AF Stop button for stopping the AF operation at anytime.
6. Focus preset enables you to focus instantly at a preset distance.
7. A truly round aperture hole results in a nicer background blur.
8. The lens is compatible with Extender EF1.4X II and EF2X II.
9. Tight seal structure ensures excellent dust-proof and drip-proof performance.
10. Designed for lighter weight with major parts made of magnesium alloy.

* Based on [1/focal length] second. Generally, it requires a shutter speed [1/focal length] second or faster to prevent camera shake.

Conventions used in this instruction



Warning to prevent lens or camera malfunction or damage.



Supplementary notes on using the lens and taking pictures.

Safety Precautions

Safety Precautions

- **Do not look at the sun or a bright light source through the lens or camera.** Doing so could result in loss of vision. Looking at the sun directly through the lens is especially hazardous.
- **Whether it is attached to the camera or not, do not leave the lens under the sun without the lens cap attached.** This is to prevent the lens from concentrating the sun's rays, which could cause a fire.
- **Do not stand on the lens case.** Falling off the case could result in injury.
- **Do not stack lens cases.** A falling lens case could cause an injury.

Handling Cautions

- **If the lens is taken from a cold environment into a warm one, condensation may develop on the lens surface and internal parts.** To prevent condensation in this case, first put the lens into an airtight plastic bag before taking it from a cold to warm environment. Then take out the lens after it has warmed gradually. Do the same when taking the lens from a warm environment into a cold one.
- Do not leave the lens in excessive heat such as in a car in direct sunlight. **High temperatures can cause the lens to malfunction.**

This device complies with Part 15 of the FCC Rules. Operation is subject to the following two conditions: (1) This device may not cause harmful interference, and (2) this device must accept any interference received, including interference that may cause undesired operation.

Do not make any changes or modifications to the equipment unless otherwise specified in the instructions. If such changes or modifications should be made, you could be required to stop operation of the equipment.

This equipment has been tested and found to comply with the limits for a class B digital device, pursuant to part 15 of the FCC Rules. These limits are designed to provide reasonable protection against harmful interference in a residential installation. This equipment generates, uses and can radiate radio frequency energy and, if not installed and used in accordance with the instructions, may cause harmful interference to radio communications.

However, there is no guarantee that interference will not occur in a particular installation. If this equipment does cause harmful interference to radio or television reception, which can be determined by turning the equipment off and on, the user is encouraged to try to correct the interference by one or more of the following measures:

- Reorient or relocate the receiving antenna.
- Increase the separation between the equipment and receiver.
- Consult the dealer or an experienced radio/TV technician for help.

This Class B digital apparatus complies with Canadian ICES-003.

Nomenclature

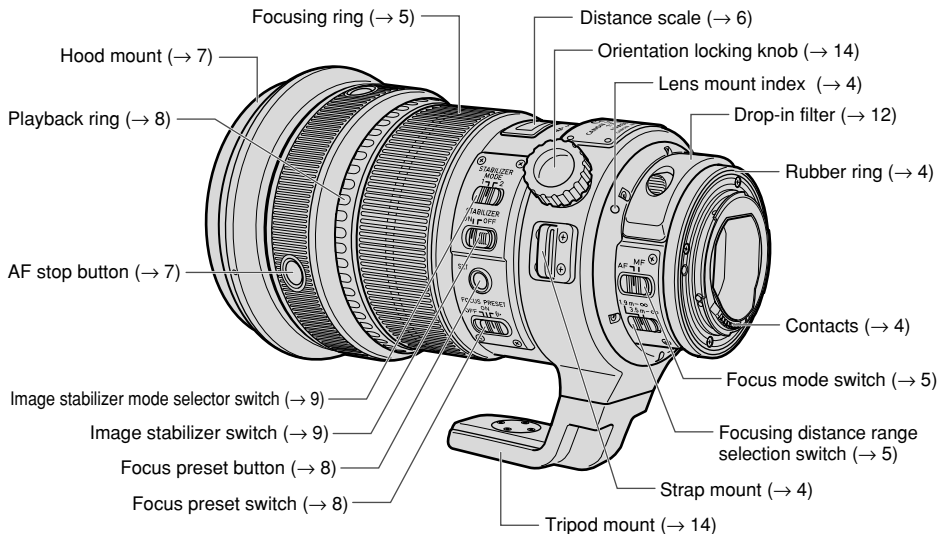



For detailed information, reference page numbers are provided in parentheses (→ **).

1. Mounting and Detaching the Lens

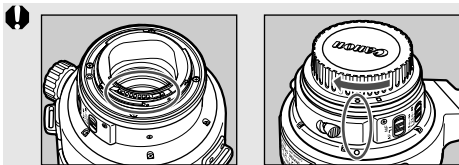
See your camera's instructions for details on mounting and detaching the lens.



- After detaching the lens, place the lens with the rear end up to prevent the lens surface and electrical contacts from getting scratched.
- If the contacts get soiled, scratched, or have fingerprints on them, corrosion or faulty connections can result. The camera and lens may not operate properly.
- If the contacts get soiled or have fingerprints on them, clean them with a soft cloth.
- If you remove the lens, cover it with the dust cap. To attach it properly, align the lens mount index and the  index of the dust cap as shown in the diagram, and turn clockwise. To remove it, reverse the order.

 The lens mount has a rubber ring for enhanced water- and dust-resistance. The rubber ring may cause slight abrasions around the camera's lens mount, but this will not cause any problems. If the rubber ring becomes worn, it is replaceable by a Canon Service Center at cost.

Attaching the strap

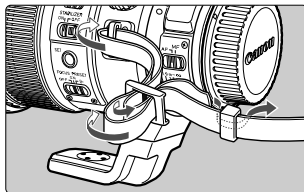

Thread the end of the strap through the strap mount on the lens and then back through the clasp on the strap. Pull the strap tight and check that there is no slack in the clasp.

2. Setting the Focus Mode

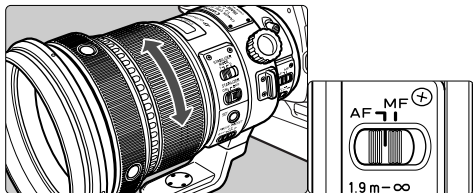

To shoot in autofocus (AF) mode, set the focus mode switch to AF.

To use only manual focusing (MF), set the focus mode switch to MF, and focus by turning the focusing ring. The focusing ring always works, regardless of the focus mode.



After autofocus in ONE SHOT AF mode, focus manually by pressing the shutter button halfway and turning the focusing ring. (Full-time manual focus)

3. Switching the Focusing Distance Range

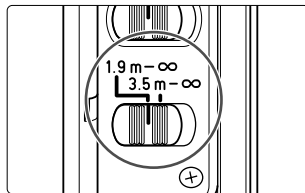

You can set the focusing distance range to 1.9 m/6.2 ft. to infinity or 3.5 m/11.5 ft. to infinity. By setting the suitable focusing distance range, the actual autofocus time can be shorter.

4. Infinity Compensation Mark

Infinity compensation mark

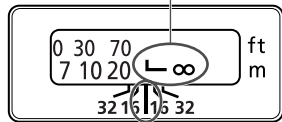

Distance index

To compensate for shifting of the infinity focus point that results from changes in temperature. The infinity position at normal temperature is the point at which the vertical line of the L mark is aligned with the distance indicator on the distance scale.

 For accurate manual focusing on subjects at infinity distance, look through the viewfinder while rotating the focusing ring.

5. Depth-of-Field Scale

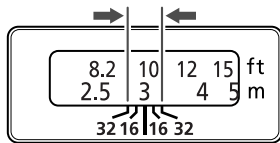

The depth of field is the distance in front of and behind the plane of focus on the subject that appears sharp. The depth of field is indicated by the area between the depth-of-field scale lines below the distance scale.

The number on the scale is the F value.

 The depth-of-field scale is an approximate indicator.

6. AF Stop Button

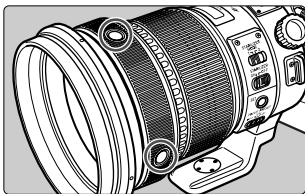

During autofocus operation, you can press the AF stop button to temporarily pause autofocus.

If the shutter button is still pressed halfway when the AF stop button is released, autofocus will continue as before.

- With the EOS 630/600, RT, A2/A2E/5, or 10S/10 set to the AI Servo AF mode and continuous shooting, AF will not resume even after you let go of the AF stop button. Press the shutter release button halfway to resume AF.
- With the EOS A2/A2E/5 and 10S/10 set to the Sports mode, AF will not resume even after you let go of the AF stop button. Press the shutter release button halfway to resume AF.



- The AF stop function also works in AI Servo AF mode.
- By setting the camera's Custom Function, you can change the AF stop button's function. For details, see the camera's instruction manual.

7. Hood

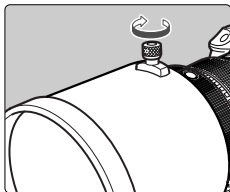
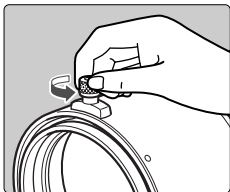

The dedicated Lens Hood ET-120B helps to prevent stray light from entering the lens and protects the front of the lens from rain, snow or dust.

To attach the hood, loosen the hood locking knob by turning it counterclockwise. Fit the hood onto the lens hood mount, and tighten the locking knob to fix it in place. Use the same procedure, in reverse, to remove the hood.

8. Focus Preset

By presetting any focusing distance, you can instantly focus at that point even while you are shooting a different subject. This function operates in both the AF and MF modes.

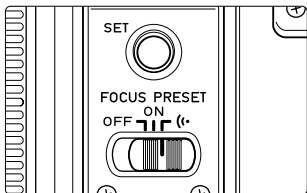

How to Set

- 1 Set the focus preset switch to ON or (☉).
- 2 Press the shutter button halfway to focus the distance you want to preset.
- 3 Press the focus preset button.
 - The focused distance will be preset.
 - If the focus preset switch was set to (☉), the beeper will sound once.

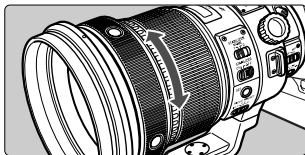

How to Focus at the Preset Distance

While turning the playback ring to the left or right, press the shutter button completely.

- The lens will focus at the preset distance.
- If the focus preset switch was set to (☉), the beeper will sound twice.



- When turning the playback ring, keep your finger away from the shutter button. In One-Shot AF mode, the exposure will be locked when you press the shutter button halfway and focus is achieved. So if you press the shutter button halfway while turning the playback ring, the exposure may not be correct.
- When not using the focus preset, set the switch to OFF.



- In the following cases, the focusing distance scale will move slightly. It will not affect the image.
- When you press the focus preset button.
 - When you turn the playback ring.

9. Image Stabilizer Settings

You can use the image stabilizer in AF or MF mode.

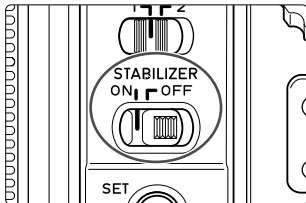

1 Set the STABILIZER switch to ON.

- If you are not going to use the image stabilizer function, set the switch to OFF.

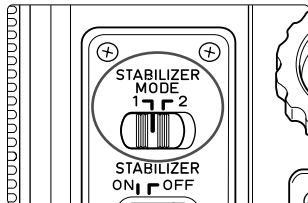

2 Select the stabilizer mode.

- **MODE 1:** Corrects vibrations in all directions. It is mainly effective for shooting still subjects.
- **MODE 2:** It compensates for vertical camera shake during following shots in a horizontal direction, and compensates for horizontal camera shake during following shots in a vertical direction.

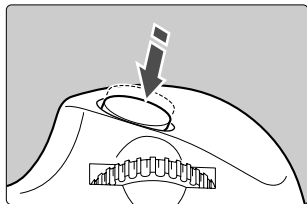

3 When you press the shutter button halfway, the Image Stabilizer will start operating.

- Make sure the image in the viewfinder is stable, then press the shutter button the rest of the way down to take the picture.

10. Tips on Using the Image Stabilizer

The image stabilizer in this lens is effective for hand-held shots under the following conditions.

● MODE 1



ON

OFF

● MODE 2



ON

OFF

- In semi-darkened areas such as indoors or outdoors at night.
- In locations where flash photography is prohibited, such as art museums and theater stages.
- In situations where your footing is uncertain.
- In situations where fast shutter settings cannot be used.

- When panning subjects in motion.

Tips on Using the Image Stabilizer



- The Image Stabilizer cannot compensate for a blurred shot caused by a subject that moved.
- Set the STABILIZER switch to OFF when you are taking pictures using the Bulb setting (long exposures). If the STABILIZER switch is set to ON, the image stabilizer function may introduce errors.
- The Image Stabilizer might not be fully effective in the following cases:
 - You shoot while riding on a bumpy road.
 - You move the camera dramatically for a panning shot in Mode 1.
 - You shoot using techniques other than following shots in Mode 2.
- The Image Stabilizer consumes more power than normal shooting, so fewer shots can be taken if you use the function.
- The image stabilizer operates for about two seconds even when your finger is off the shutter button. Do not remove the lens while the stabilizer is in operation. This will cause a malfunction.
- With the EOS-1V/HS, 3, ELAN 7E/ELAN 7/30/33, ELAN 7NE/ELAN 7N/30V/33V, ELAN II/ELAN II E/50/50E, REBEL2000/300, IX, and D30, the Image Stabilizer will not work during self-timer operation.



- Using a tripod also stabilizes the image. However, depending on the kind of tripod and shooting conditions, sometimes it may be better to turn off the Image Stabilizer function.
- The stabilizer is equally effective for hand-held photography and photography with a monopod.
- The Image Stabilizer function also operates when the lens is used with the EF12 II or EF25 II Extension Tube, and the EF1.4X II or EF2X II Extender.
- Pictures may look distorted after being taken depending on the camera, but this doesn't affect shooting.
- If you set the camera's Custom Function to change the assigned button to operate the AF, the Image Stabilizer will operate when you press the newly assigned AF button.

11. Drop-In Filters

The lens comes with the drop-in Gelatin Filter Holder 52 holding a glass filter. The holder accepts commercially-available gelatin filters.

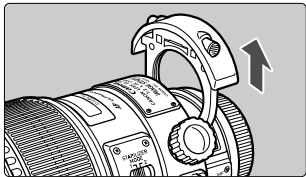

Removing and Installing

To remove the drop-in filter, press in the left and right lock buttons and pull the filter holder straight up out of the slot.

To install the drop-in filter, push the filter holder straight down into the slot until it clicks into place.

- The filter holder can be installed facing either forwards or backwards.

 Because the lens optics are designed to include a glass filter, you must always install the filter holder, even if no gelatin filter is fitted.

Using a Gelatin Filter

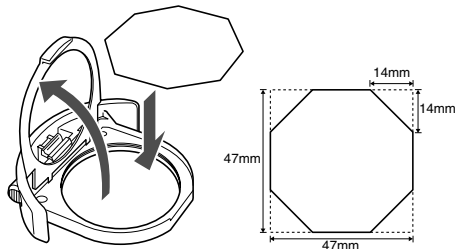

- 1 Lift up the holder's retaining frame
- 2 Trim the gelatin filter as shown in the figure, and mount it in the holder.
- 3 Return the retaining frame to its closed position.



The Drop-In Screw-Type Filter Holder 52 and Drop-In Circular Polarizing Filter PL-C52 are also available (Sold separately).

12. Extenders (Sold separately)

With Extender EF1.4X II or EF2X II attached, the lens specifications will change as follows:

Item		With EF1.4X II Extender	With EF2X II Extender
Focal length (mm)		280	400
Aperture		f/2.8 – 45	f/4 – 64
Angle of view	Diagonal	8°50'	6°10'
	Vertical	4°55'	3°30'
	Horizontal	7°20'	5°10'
Maximum magnification (×)		0.18	0.24



- First attach the Extender to the lens, then attach the lens to the camera. Detach it from the camera in the reverse order. If you attach the lens to the camera first, misoperation may occur.
- Only one Extender can be attached to the lens and camera.
- If you use an Extender on the lens mounted on a EOS A2/A2E/5, set the exposure compensation to -1/2 stop for the EF1.4X II or -1 stop for the EF2X II.



When an Extender is attached, the AF speed will become slower by design to retain proper AF control.

13. Extension Tubes (Sold separately)

You can attach Extension Tube EF12 II or EF25 II for magnified shots. The shooting distance and magnification are shown below.

	Camera-to-Subject Distance (mm)		Magnification	
	Near	Far	Near	Far
EF12 II	1380	3397	0.19×	0.06×
EF25 II	1092	1716	0.26×	0.14×



Manual focusing is recommended for accurate focusing.

14. Using the Tripod Mount

Adjusting the Revolving Mount

You can loosen the orientation lock-knob on the tripod mount to allow it to rotate as needed to fit a particular camera model for switching between vertical and horizontal positions.

15. Case

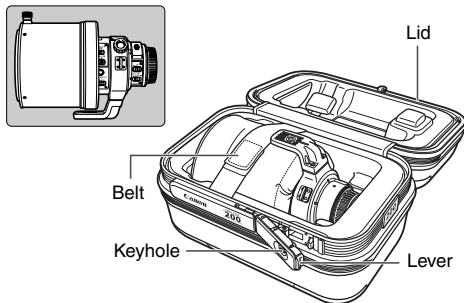

When putting the lens into its case, follow the procedure below.

- 1 Attach the hood in reverse direction, then attach the lens cap. Keep the hood locking knob facing the direction opposite the tripod mount as shown in the left figure.
- 2 Position the tripod mount straight upwards and lay the lens into the case as shown in the right figure.
- 3 Secure the lens with the belt.
- 4 Press the lever while holding the lid from the top, and lock it.

Specifications

Focal Length/Aperture	200 mm f/2
Lens Construction	12 groups, 17 elements
Minimum Aperture	f/32
Angle of View	Diagonal: 12° Vertical: 7° Horizontal: 10°
Min. Focusing Distance	1.9 m/6.2 ft.
Max. Magnification	0.12 ×
Field of View	approx. 97 × 145 mm/3.8 × 5.7 inch (at 1.9 m)
Filter	Drop-in 52-series
Max. Diameter and Length	128 × 208 mm/5.0 × 8.2 inch
Weight	2520 g/88.9 oz.
Hood	ET-120B
Lens Cap	E-145B
Case	Lens Case 200

- The lens length is measured from the mount surface to the front end of the lens. Add 26.5 mm when including the lens cap and dust cap.
- The size and weight listed are for the lens only, except as indicated.
- Closeup Lenses 250D/500D cannot be attached.
- Aperture settings are specified on the camera.
- All data listed is measured according to Canon standards.
- Product specifications and appearance are subject to change without notice.

Canon