

# Canon EF LENS

EF28-135mm f/3.5-5.6 IS USM

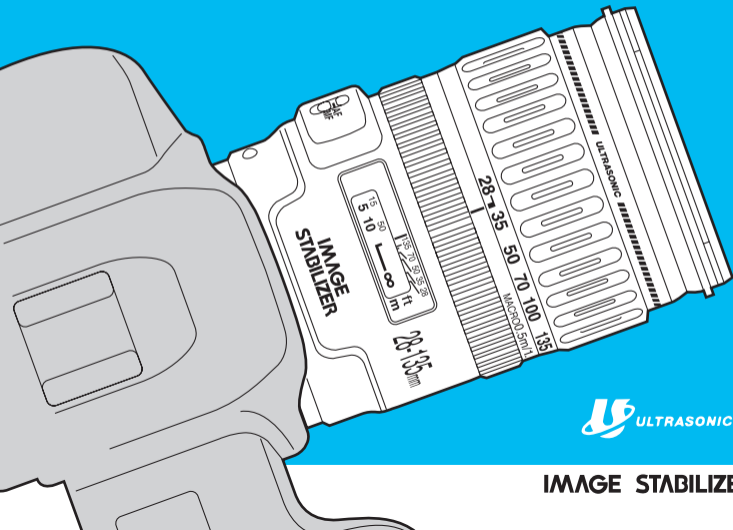

IMAGE STABILIZER

ENG

Instruction

# English Instructions

## Thank you for purchasing a Canon product.

Canon EF28-135mm f/3.5-5.6 IS USM is a high-performance lens developed for EOS cameras that incorporates an Image Stabilizer function.

- "IS" stands for Image Stabilizer.
- "USM" stands for Ultrasonic Motor.

### Handling Cautions

**If the lens is taken from a cold environment into a warm one, condensation may develop on the lens surface and internal parts.** To prevent condensation in this case, first put the lens into an airtight plastic bag before taking it from a cold to warm environment. Then take out the lens after it has warmed gradually. Do the same when taking the lens from a warm environment into a cold one.

## Features

1. The Image Stabilizer gives the equivalent effect of a shutter speed two stops\* faster.
2. High-magnification zoom from 28 mm wide-angle to 135 mm telephoto.
3. Ultrasonic motor (USM) for fast, quiet autofocus.
4. Manual focusing is available after the subject comes into focus in autofocus mode (ONE SHOT AF).
5. Great close-ups at 0.5 m/1.6 ft at all focal lengths.

\* Based on  $[1/\text{focal length}]$  second.  
Generally, it requires a shutter speed  $[1/\text{focal length}]$  second or faster to prevent camera shake.

### Conventions used in this instruction



Warning to prevent lens or camera malfunction or damage.



Supplementary notes on using the lens and taking pictures.

# Safety Precautions

## Safety Precautions

1. **Do not look at the sun or a bright light source through the lens or camera.** Doing so could result in loss of vision. Looking at the sun directly through the lens is especially hazardous.
2. **Whether it is attached to the camera or not, do not leave the lens under the sun without the lens cap attached.** This is to prevent the lens from concentrating the sun's rays, which could cause a fire.

This device complies with Part 15 of the FCC Rules. Operation is subject to the following two conditions: (1) This device may not cause harmful interference, and (2) this device must accept any interference received, including interference that may cause undesired operation.

Do not make any changes or modifications to the equipment unless otherwise specified in the instructions. If such changes or modifications should be made, you could be required to stop operation of the equipment.

This equipment has been tested and found to comply with the limits for a class B digital device, pursuant to part 15 of the FCC Rules. These limits are designed to provide reasonable protection against harmful interference in a residential installation. This equipment generates, uses and can radiate radio frequency energy and, if not

installed and used in accordance with the instructions, may cause harmful interference to radio communications.

However, there is no guarantee that interference will not occur in a particular installation. If this equipment does cause harmful interference to radio or television reception, which can be determined by turning the equipment off and on, the user is encouraged to try to correct the interference by one or more of the following measures:

- Reorient or relocate the receiving antenna.
- Increase the separation between the equipment and receiver.
- Consult the dealer or an experienced radio/TV technician for help.

---

This Class B digital apparatus complies with Canadian ICES-003.

---

# Nomenclature

---

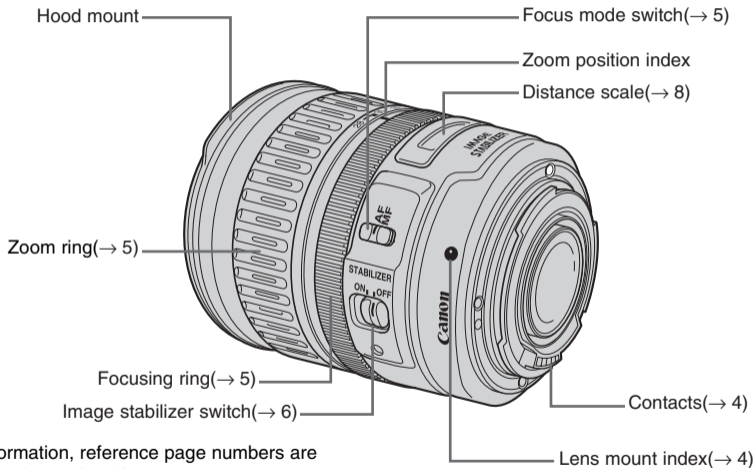

For detailed information, reference page numbers are provided in parentheses (→ \*\*).

# 1. Mounting and Detaching the Lens

See your camera's instructions for details on mounting and detaching the lens.



- After detaching the lens, place the lens with the rear end up to prevent the lens surface and contacts from getting scratched.
- If the contacts get soiled, scratched, or have fingerprints on them, corrosion or faulty connections can result. The camera and lens may not operate properly.
- If the contacts get soiled or have fingerprints on them, clean them with a soft cloth.
- If you remove the lens, cover it with the dust cap. To attach it properly, align the lens mount index and the  $\circ$  index of the dust cap, and turn clockwise. To remove it, reverse the order.

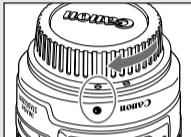
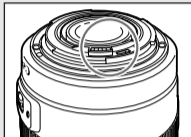

## 2. Zooming

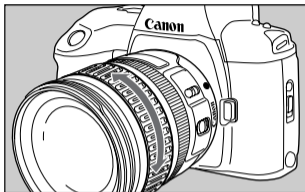

To zoom, turn the lens' zoom ring.



Be sure to finish zooming before focusing. Changing the zoom ring after focusing can affect the focus.

## 3. Setting the Focus Mode

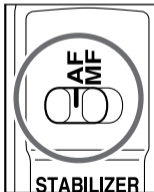

To shoot in autofocus (AF) mode, set the focus mode switch to AF.  
To shoot in manual focus (MF) mode, set the focus mode switch to MF, and focus by turning the focusing ring. The focusing ring always works, regardless of the focus mode.



After autofocusing in ONE SHOT AF mode, focus manually by pressing the shutter button halfway and turning the focusing ring. (Full-time manual focus)

## 4. Image Stabilizer

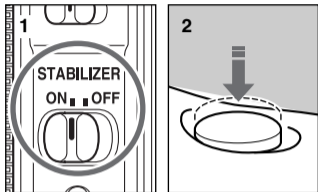

You can use the image stabilizer in AF or MF mode.

1. Set the STABILIZER switch to ON.
  - If you are not going to use the image stabilizer function, set the switch to OFF.
2. When you press the shutter button halfway, the Image Stabilizer will start operating.
  - Make sure the image in the viewfinder is stable, press the shutter button the rest of the way down to take the picture.



If you set the camera's Custom Function to change the assigned button to operate the AF, the Image Stabilizer will operate when you press the newly assigned AF button.



OFF



ON

## 5. Tips on Using the Image Stabilizer

---

The image stabilizer in this lens is effective for hand-held shots under the following conditions.

- In semi-darkened areas such as indoors or outdoors at night.
- In locations where flash photography is prohibited, such as art museums and theater stages.
- In situations where your footing is uncertain.
- In situations where fast shutter settings cannot be used.



- The Image Stabilizer cannot compensate for a blurred shot caused by a subject that moved.
- Set the STABILIZER switch to OFF when using the camera on a tripod. If the switch is set to ON, the Image Stabilizer may introduce errors.
- Set the STABILIZER switch to OFF when you are taking pictures using the Bulb setting (long exposures). If the STABILIZER switch is set to ON, the image stabilizer function may introduce errors.
- The Image Stabilizer might not be fully effective in the following cases:
  - You move the camera for a panned shot.
  - You shoot while riding on a bumpy road.
- The Image Stabilizer consumes more power than normal shooting, so fewer shots can be taken if you use the function.
- The image stabilizer operates for about two seconds even when your finger is off the shutter button. Do not remove the lens while the stabilizer is in operation. This will cause a malfunction.
- With the EOS-1V/HS, 3, ELAN 7E/ELAN 7/30/33, ELAN 7NE/ELAN 7N/30V/33V, ELAN II/ELAN II E/50/50E, REBEL 2000/300, IX, IX Lite/IX7, and D30, the Image Stabilizer will not work during self-timer operation.



- The stabilizer is equally effective for hand-held photography and photography with a monopod.
- The image stabilizer function also operates when the lens is used with an extension tube EF12 II or EF25 II.
- Depending on the camera there may be image shake, such as after releasing the shutter. However, this does not affect shooting.
- If you set the camera's Custom Function to change the assigned button to operate the AF, the Image Stabilizer will operate when you press the newly assigned AF button.



## 6. Infinity Compensation Mark

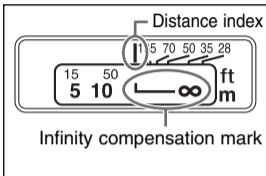

To compensate for shifting of the infinity focus point that results from changes in temperature. The infinity position at normal temperature is the point at which the vertical line of the L mark is aligned with the distance indicator on the distance scale.



For accurate focusing in MF on subjects at infinity distance, look through the viewfinder while rotating the focusing ring.

## 7. Infrared Index

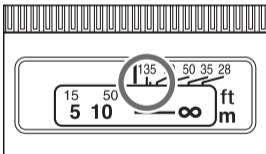

The infrared index corrects the focus setting when using monochrome infrared film.

Focus on the subject in MF, then adjust the distance setting by moving the focusing ring to the corresponding infrared index mark.



Some EOS cameras cannot use infrared film. See the instructions for your EOS camera.



- The infrared index position is based on a wavelength of 800 nm.
- Be sure to observe the manufacturer's instructions when using infrared film.
- Use a red filter also when you take the picture.

## 8. Hood and Filters

### Hood (Sold Separately)

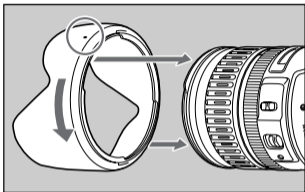

The EW-78B II lens hood can keep unwanted light out of the lens, and also protects the lens from rain, snow, and dust. To attach the hood, align the hood's attachment position mark with the red dot on the front of the lens, then turn the hood in the direction of the arrow until the lens's red dot is aligned with the hood's stop position mark. The hood can be reverse-mounted on the lens for storage.



- Part of the picture may be blocked if the hood is not attached properly.
- When attaching or detaching the hood, grasp the base of the hood to turn it. To prevent deformation, do not grasp the rim of the hood to turn it.

## Filters (Sold Separately)

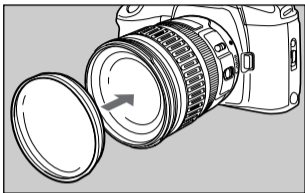

You can attach filters to the filter mounting thread on the front of the lens.



- Only one filter may be attached.
- Use a polarizing Canon filter (72mm).
- To adjust the polarizing filter, first remove the lens hood.

## 9. Extension Tubes (Sold Separately)

You can attach extension tube EF12 II or EF25 II for magnified shots. The shooting distance and magnification are shown below.

		Focusing Distance Range (mm)		Magnification (×)	
		Close distance	Long distance	Close distance	Long distance
EF12 II	28mm	180	196	0.53	0.42
	135mm	336	1624	0.37	0.09
EF25 II	28mm	169	174	1.09	0.94
	135mm	280	876	0.58	0.21



MF mode is recommended for accurate focusing.

## 10. Close-up Lenses (Sold Separately)

Attaching a close-up lens 500D (72mm) enables close-up photography. Magnification is from 0.31 to 0.06 times.



- Close-up Lens 250D cannot be attached because there is no size that fits the lens.
- MF mode is recommended for accurate focusing.

# Specifications

---

**Focal Length/Aperture:** 28–135 mm f/3.5–5.6

**Lens Construction:** 12 groups, 16 elements

**Minimum Aperture:** f/22-36

**Angle of View** (Diagonal, vertical, horizontal extents): 75–18°, 46–10°, 65–15°

**Min. Focusing Distance:** 0.5 m/19.7 in.

**Max. Magnification:** 0.19×

**Field of View:** 125 × 188 mm/4.9 × 7.4 in. (at 135 mm, 0.5 m/19.7 in.)

**Filter Diameter:** 72 mm

**Max. Diameter and Length:** 78.4 × 96.8 mm/3.1 × 3.8 in.

**Weight:** 540 g/19 oz

**Hood:** EW-78B II (Sold Separately)

**Lens Cap:** E-72U

**Case:** LP1116 (Sold Separately)

- The lens length is measured from the mount surface to the front end of the lens. Add 21.5 mm when including the lens cap and dust cap.
- The size and weight listed are for the lens only, except as indicated.
- The EF1.4× II/EF2× II extenders cannot be used with this lens.
- Aperture settings are specified on the camera. The camera automatically compensates for variations in the aperture setting when the camera is zoomed in or out.
- All data listed is measured according to Canon standards.
- Product specifications and appearance are subject to change without notice.

# Canon