

User Manual

manuel d'utilisation | benutzerhandbuch | manual del usuario
gebruikershandleiding | manuale per l'utente | manual do usuário
användar-handbok

Digital Audio Player

Lecteur audio numérique | Digitaler Audio-Player | Reproductor de audio digital
Digitale audiospeler | Lettore audio digitale | Leitor Áudio Digital
Digital ljudspelare



PHILIPS

Contents

Welcome

About your new product	1
Accessories	1
Register your product	1
More information	1

Connect and Charge

Charging your device	2-3
Indication of power level.....	4

Enjoy

Powering on and off	4
Front of device	5
Back of device.....	6
Root menu	7
Navigation	7
Music mode	8
Searching for your desired music.....	8
Playback	9
Customizing playback	9
Getting digital music onto your device	10
Radio mode***	11
Using the stopwatch	12
Tracking your workout progress.....	12
Using the talking stopwatch.....	13
Using ShockLock during music playback.....	14
Customizing settings	15
Wearing player on your arm	16

Troubleshooting	17
------------------------------	----

Safety and Maintenance

General maintenance	18
About operating and storage temperatures	18
Take care when using headphones	18
Copyright information	19
Environmental information	19
Disposal of your old product	19
Modifications	19

Notice for the USA	20
---------------------------------	----

Notice for the Canada and European Union	20
---	----

Technical data	21
-----------------------------	----

About Philips Device Manager and Windows Media Player

About Philips Device Manager.....22
About Windows Media Player.....22

Windows Media Player 10

Search and add tracks to the Library.....23-24
Transfer tracks to your device.....25-26
Add Tracks to a Playlist on your PC using WMP27
Delete Tracks and Playlists.....28
Edit Track Information29
Search for Tracks.....30

Update and repair with Philips Device Manager

Upgrade31
Firmware Update31
Device Repair.....32

Welcome

About your new product

With your newly purchased product, you can enjoy the following:

- MP3 and WMA playback (see [MUSIC MODE](#) section)
- FM radio*** (see [RADIO MODE](#) section)
- Workout progress tracking

***FM radio is only available to some regional versions. FM radio is currently not available in Europe.

Accessories



Headphones



USB cable



Multi-voltage adaptor



Armband



CDROM with user manual, drivers, FAQ, music management softwares

Register your product

Since it is possible for you to upgrade your product, we recommend that you register your product on www.philips.com/register so we can inform you as soon as new free upgrades become available.

More information

Please visit www.philips.com/support to view:

- FAQ, Frequently Asked Questions
- Latest user manuals
- Latest PC software downloads
- Firmware upgrade files and Device Manager

The model and production numbers can be found inside the battery compartment.

Connect and Charge

Charging your device

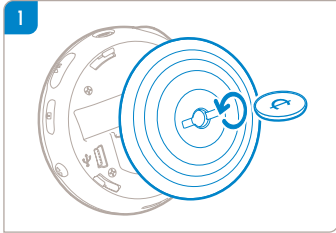

Use an appropriately-sized coin to twist anti-clockwise to unlock the back cover:



TIP

You can also twist open the cover without using a coin. Grip on the rubber part of the back cover. Without moving your gripping point, gently twist anti-clockwise to open.

- ② Connect the included multi-voltage adaptor / charger into the jack marked 5V DC, and then plug the multi-voltage adaptor / charger into a standard AC outlet.

Please charge for 4 hours for 100% battery power for first time use. Fast charge: 1 hour.

The device is fully charged when the charging animation stops and the icon  shows.

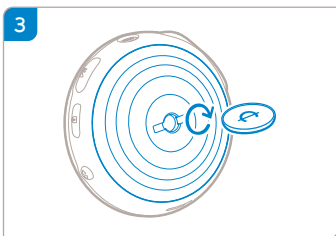

Match the latches on the cover with the slots in your device. Twist clockwise gently to replace the back cover.



TIP

You can also charge your device during USB connection. Please connect your device to your computer using the included USB cable.

To charge your device battery via USB, you must:

- ① Have a high power USB port (many computers will pop up a warning message if you connect your device and to a PC with a lower power USB port)
- ② Ensure that your device battery is not empty
- ③ Connect your device to a high-power USB 2.0 port on your computer.

IMPORTANT!

Connecting your device to a USB port on your keyboard will not charge the battery.

If your device is exceptionally low on power, you will see below warning message on your device.



This means that you must connect your device to a power outlet using the by-packed power adapter / charger. Charge your device for at least 30 minutes (1 hour is recommended), then connect it to your computer again to transfer music. Always check the battery status icon on your device display.

If Songs Transfer More Slowly Over USB 2.0

If you transfer a large amount of songs or data using USB 2.0 and the device battery is low, your device will go into power-saving mode. Transfer speeds will slow down considerably. This is normal.

If you want to transfer at higher speeds, you can stop the transfer; eject your device, and connect it to a power outlet using the by-packed power adapter / charger. Charge your device for at least 30 minutes (1 hour is recommended), then connect it to your computer again to transfer music.

Indication of power level

You can see the approximate power level of your batteries on the display.



Battery full



Battery two-thirds full



Battery half full



Battery low



Battery empty

Note: Rechargeable batteries show lower voltage levels when compared to alkaline ones. Batteries contain chemical substances, so they should be disposed of properly.



TIP

When the batteries are nearly empty, the battery low screen  blinks and the beep tone sounds once. When you hear a double beep, your device will power down. Your device will save all settings and un-finished tracking before it powers down.

Rechargeable batteries have a limited number of charge cycles and may eventually need to be replaced. Battery life and number of charge cycles vary by use and settings.

Enjoy

Powering on / off

Power on: Press and hold **▶||**.

→ PHILIPS splash screen appears briefly

PHILIPS

Power off: Press and hold **▶||** again.



TIP

Your device automatically powers down if there is no operation and no music played for 10 minutes. Last playback status / screen will be resumed at next powering on.

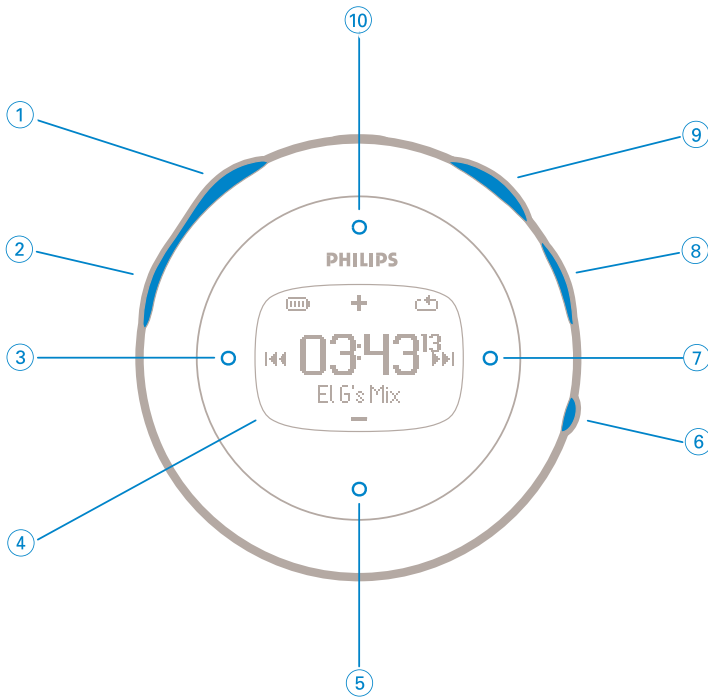

Front of device

① Talking stopwatch	Activates voice feedback telling you "elapsed time"
② Stopwatch	Press to start, pause, or reset
③ Previous	Rewinds / Up 1 level / Skip to previous
④ Display	Dynamically displays menu, options and track information
⑤ VOL - / Move down	Navigate down / volume down in playscreen
⑥ VIEW	To switch between root menu, library and now playing screens.
⑦ Next	Fast forward / Down to 1 level / Skip to next
⑧ Lock key	Disables / enables key lock and ShockLock
⑨ ►►	Power on / off and Play / Pause
⑩ VOL + / Move up	Navigate up / volume up in playscreen

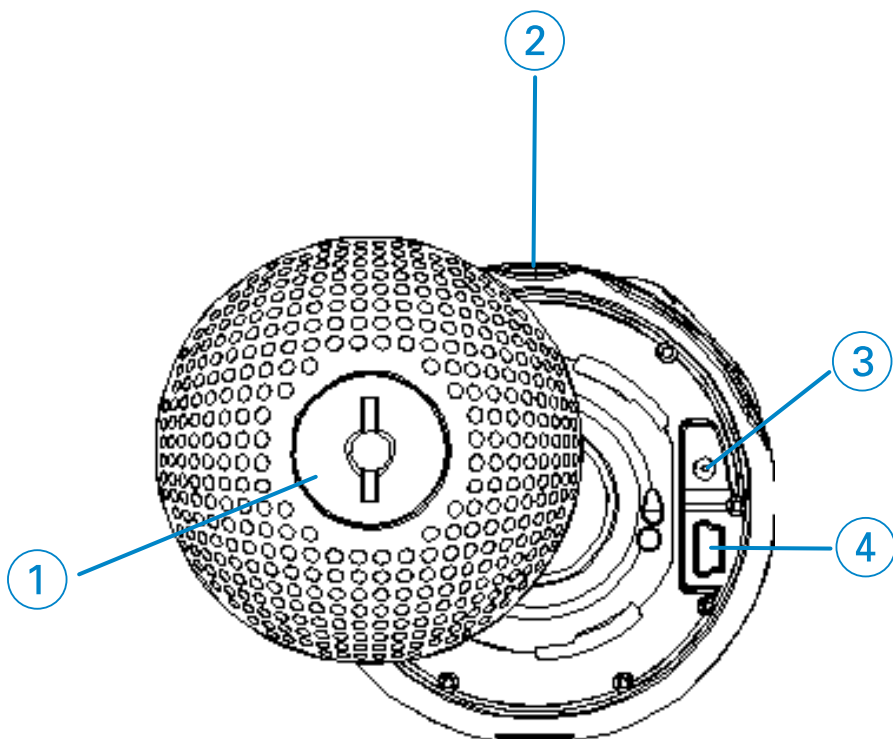

Back of device

- ① Back Cover Insert a coin here to twist open / close back cover; connects to arm band
- ②  Headphones jack
- ③ Charging socket
- ④ USB cable connector

Root menu

When your device powers up, you will see the ROOT MENU.

Music	enter to play your digital music tracks
Radio***	enter to listen to your radio presets
Sport	enter to view your workout summary
Settings	enter to customize settings for your device

***FM radio is only available in some regional versions. FM radio is currently not available in Europe..

Navigation

Your device has an intuitive menu navigation system to guide you through various settings and operations. Use ▲, ▼, ◀, ▶ to browse through menus. Press ► to confirm your selection.

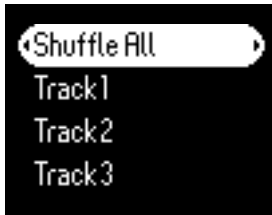
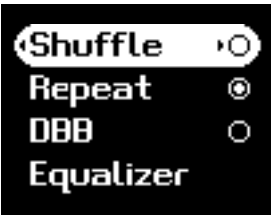
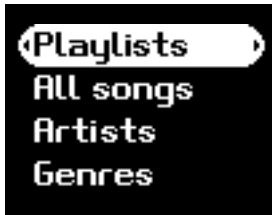

TIP

Select Shuffle All to play all your device music in a random way.

Music mode

We have put some music tracks on your device so that you can jump start your music experience. You can also transfer your digital music collection from your computer to your device through the included music management software.

(see [GETTING DIGITAL MUSIC ON YOUR DEVICE](#) for more information)

IMPORTANT!

We recommend that you use the Sync function in Windows Media Player 10 to transfer music to your player.

Searching for your desired music

- 1 From the root menu, select MUSIC to enter the music mode. As you enter the music mode, you can search from the following display options:

Playlists	— Playlists collections	— Tracks listed in play order		
All songs	— Shuffle All Alphabetically listed tracks			
Artists	— Alphabetically listed artists	— Alphabetically listed albums	— Tracks listed in album order	
Genres	— Alphabetically listed genres	— Alphabetically listed artists	— Alphabetically listed albums	— Tracks listed in album order
Albums	— Alphabetically listed albums	— Tracks listed in album order		

Note: If your music is missing any ID3 tag information, then you may find empty fields or an indication stating "No artist found" or "No album found" or "No genres found".

- 2 Press ▲ to scroll up or ▼ to scroll down for your option. Press ► for next or ◀ for previous levels.
- 3 Press ►|| to play your selection.



TIP

You can also press and hold ▲ or ▼ key to SuperScroll. An enlarged head letter will show as the tracks scroll quickly. Stop pressing when you have arrived at your desired head letter.



Playback

The keys: **▶||**, **ⓧ**, **⓪**, **ⓩ**, **⓷** (see drawing on page 5) are multi-functional. They work according to how you press them: *press* or *press and hold*. During music playback, you can do the following:

Basic Operation	Controls to press
Pause music	Press ▶ during playback
Go to next track	Press ⓷
Go to previous track	Press ⓩ
Forward search	Press and hold ⓷
Backward search	Press and hold ⓩ
Volume control	ⓧ / ⓪

Customizing playback

Changing play modes

- 1 From the root menu, select **Settings**.
- 2 Use scroll controls to select the following options. Press **▶||** to confirm your selection.
Press **▶||** to deselect a checked option.

Play mode	Shuffle	Repeat
Shuffle	On	Off
Repeat	Off	On
Shuffle and repeat	On	On
Normal	Off	Off

Changing Bass Enhancement

- 1 From the root menu, select **Settings > DBB**.
- 2 Use scroll controls to select **On** or **Off**.

Changing equalizers

- 1 From the root menu, select **Settings > EQ**.
- 2 Use scroll controls to select **Rock, RnB, Electronica, Hip Hop, Classical, Jazz**.

Getting digital music onto your device

Before you can transfer your MP3 and/or WMA collection to your device using Windows Media Playe, you need to have both Windows Media Player and Philips Device Manager installed on your PC as follows:

Install Philips Device Manager and Windows Media Player

- ① Insert the supplied CD into your computer's CD-ROM drive.
If the CD does not autorun, please click the **.exe** from the root directory of the CD.
- ② Select your language and follow screen instructions to complete installation of Philips **Device Manager and Windows Media Player**.

Connect your device to the computer

- ① Connect your device to your computer using the supplied USB cable. A USB connection animation will be shown as soon as your device is connected.
- ② You can organize files and transfer music to your device during USB connection.

Organize and transfer your music using Windows Media Player 10

- ① Launch Windows Media Player from Windows desktop or Start menu.
- ② To transfer files from your computer to your device, click Copy to CD or Device / Sync tab.
- ③ In the Items to Copy pane, in the drop-down list, click the playlist, category, or other item that you want to copy.
- ④ Clear the check boxes next to any files you do not want to copy.
- ⑤ In the Items on Device pane, in the drop-down list, click the device that you want to copy files to, i.e. PHILIPS GoGear / PHILIPS device.
- ⑥ Click the Start Sync button.

Music files may be transferred using Windows Explorer (by drag and drop) to your device only if they are saved in the following folder: "media"



If your Windows Media Player is open when you connect your device, your device may not be recognized.

Radio mode***

***FM radio is only available to some regional versions. FM radio is currently not available in Europe..

Select your FM region

- 1 From the root menu, select **Settings > Advanced > Radio settings**.
- 2 Select your region. Press ▶ to confirm your selection.

Auto tune

- 1 From the root menu, select **RADIO** to enter the radio mode.
- 2 Press ◀ from P1 or ▶ from P10 to select **Autotune**. Press ▶▶ to confirm.
 - ➔ Your device will automatically select the 10 strongest available stations. Press any key to abort



TIP

Please ensure that you connect the bypacked headphones during auto tuning of your radio presets since the headphone cable functions as an antenna.

Playing a radio station

- 1 From the root menu, select **RADIO** to enter the radio mode.
- 2 Press ◀ for the previous or ▶ for the next preset.

Manual tune

- 1 From the radio play screen, press and hold ▶ to start manual tune.
- 2 Press ◀ or ▶ to tune step by step.
 - ➔ The screen indicates the change in frequency. You will hear a hissing sound / the tuned station as you manual tune.
- 3 Press and hold ◀ to search for the last available station or press and hold ▶ to search for the next available station.
- 4 Press ▶▶ to confirm and save your preset.



TIP

If you do not want to store a manual tuned preset, do not press any key. The manual tuning screen will time out without saving. The headphone wire is used as an FM antenna. If necessary, move it for optimum reception.

Using the stopwatch

You can use your device as a stopwatch to track your workout progress. All stopwatch activities will be recorded and stored on your device.

During use of stopwatch, you may press the talking stopwatch key to hear your elapsed time via the headphones.

Stopwatch operation	Controls to press
Go to stopwatch screen	Press and hold ② (see "Front of device section" on p.5)
Start timing	Press ② from stopwatch screen
Pause timing	Press ② when stopwatch is active
Resume timing	Press ② when stopwatch is paused
Reset stopwatch	Press and hold ②

The screen shots below show what you see when you are using stopwatch.



The talking stopwatch voice feedback is available in: English, French, German and Spanish only. These are linked to the language selection that you make in Settings. All other languages have English voice feedback.

Tracking your workout progress

You can use your device as a stopwatch to track your workout progress.

- ① From root menu, select **Sport > History**.



- ② You can view a list of recorded workout logs. Press ▶ to view details. You will see the date of your workout and the elapsed time of your workout.

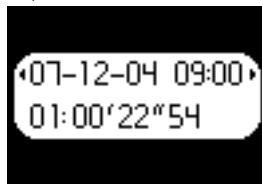
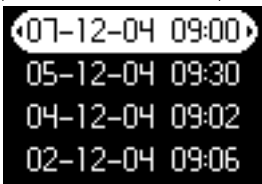

Using the talking stopwatch

- 1 Press clock to start stopwatch.



- 2 Press for elapsed time.

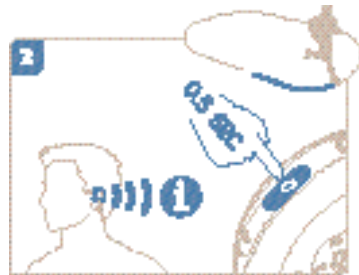

- 3 Press clock to stop stopwatch.

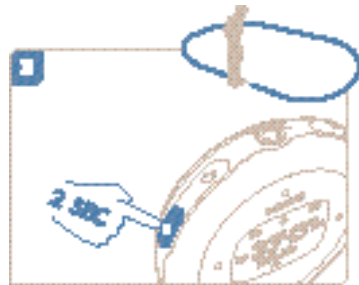

The talking stopwatch voice feedback is available in: English, French, German and Spanish only. These are linked to the language selection that you make in Settings. All other languages have English voice feedback.

Using ShockLock during music playback

All hard disk players may be vulnerable to shock which may affect the quality of your music enjoyment during vigorous workouts or activities. Philips has come with an innovation to further protect your player during rigorous exercise called ShockLock.

ShockLock can be activated on any selection of music you own (that is on any music that does not come from music subscription services) so you can enjoy your favorite music while on the move without being interrupted by shock.

To activate ShockLock during music playback, follow the instructions below.

- 1 Press LOCK key. Select ShockLock.



- 2 Device shows loading mode.

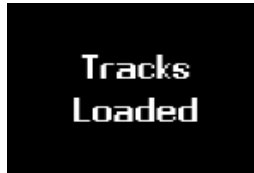
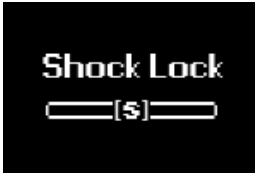

- 3 During ShockLock mode, you can only listen to songs loading into the buffer. The number of songs that fit into the buffer varies. You can expect that between 4 and 12 songs will fit. These songs will play continuously in Repeat mode until you deactivate ShockLock or your battery is depleted.



- 4 To deactivate ShockLock, press and hold LOCK and deselect ShockLock, or turn off your player. During ShockLock mode, the default music playback mode is Repeat playback mode.

During ShockLock loading, you may get a message informing you that the feature is only possible to activate for non-subscription songs. In order not to violate any agreements you may have with your music subscription services and to protect your subscription count only songs that you actually own can be loaded into ShockLock mode. Songs acquired through music subscription services can be played in normal playback mode.



TIP

During ShockLock mode, you may not be able to access some functions of your player. If you wish to perform new functions, please deactivate ShockLock mode first.

Customizing settings

- ① From the root menu, select **Settings**.
- ② Press ▲ to scroll up or ▼ to scroll down for your option. Press ► for next or ◀ for previous levels.
- ③ Press ► to confirm your selection.
- ④ Press ◀ once or more to exit the menu display.



TIP

Options for each setting are shown on the device display.

Setting	Function
Shuffle	Play tracks in random order
Repeat	Play tracks repeatedly
SmartSave	Battery power saving mode
DBB	Base enhancement
Equalizer	Rock / R&B / Electronica / Hip Hop / Classical / Jazz / Off
Backlight	5 seconds / 10 seconds / 30 seconds / Off
Contrast	Levels 1 - 6
Language	English, French, German, Spanish, Italian, Portuguese (Brazilian), Dutch, Swedish, Chinese (Simplified), Chinese (Traditional), Japanese, Korean
Factory settings	Restore factory settings
Information	Free space / About
Advanced	
Radio Settings	USA / Europe / Japan
Smart Hide	Off / 1 / 2 / 3 / 4
Voice Feedback	On time / On demand



TIP

- SmartSave is a battery power saving mode. During this mode, certain features that consume high power, such as DBB and EQ are deactivated for optimal battery performance.

- Smart Hide is a function to hide some library information..With Smart Hide, you can scroll faster to the right content by hiding albums and artists which contain songs that are fewer than a specified number:

Smart Hide 1 will hide all artists and albums that has only 1 track in the library.
Smart Hide 2 will hide all artists and albums that has only 2 or fewer tracks in the library.
Smart Hide 3 will hide all artists and albums that has only 3 or fewer tracks in the library.
Smart Hide 4 will hide all artists and albums that has only 4 or fewer tracks in the library.

Wearing player on your arm

- ① Attach device to armband, matching the cover latch with the armband cup.

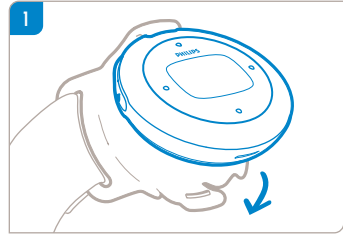

TIP

Ensure that the headphone socket is pointing upward. You will hear a click sound when you have secured the player.

- ② Connect headphones.

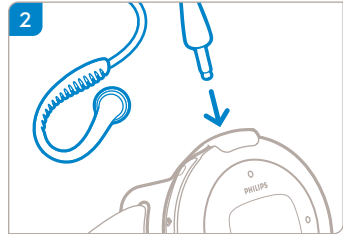

- ③ Adjust fitting and wear on your arm.

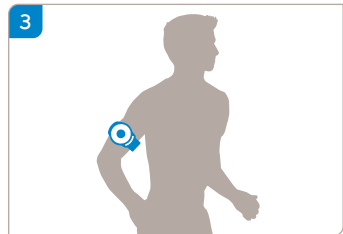

Troubleshooting

If a fault occurs, first check the points listed in the following pages. For further help and other troubleshooting tips, please also check out FAQs at www.philips.com/support.
If you are unable to find a solution by following these hints, consult your dealer or service center:

WARNING:

Under no circumstances should you try to repair the set yourself, as this will invalidate the warranty.

Symptom	Solution
Hang up	Press and hold [VOLUME +] and ▶ simultaneously. Your device will reset.
Cannot power up	Charge your device. In case of device error, connect your device to the computer. Use Device Manager to restore your device.
Device shows "Player problem"	Device / memory card error. Connect your device to the computer. Use Philips Device Manager to repair your device.
Device shows <input type="checkbox"/> <input type="checkbox"/> <input type="checkbox"/> <input type="checkbox"/> <input type="checkbox"/> <input type="checkbox"/> <input type="checkbox"/> <input type="checkbox"/> <input type="checkbox"/>	You have transferred music tracks with Chinese, Japanese, Korean or other languages to your device. You need the corresponding fonts to display this information correctly. Press Settings . Select Language . Select the source language of the music tracks. Note: Your music still plays even this information is not shown properly.
No sound when the ▶ button is pressed on my PSA player	<ul style="list-style-type: none"> - You may have a weak battery. Charge your device. - Check if your headphone plug has been inserted into the headphone jack of the unit completely - When you press the ▶ button, make sure that it is pressed and held for long enough until the display light up. - Check if the volume is at an audible level. Increase the volume using the VOLUME + button. - If psa is in pause mode, press the ▶ button to resume playback. - Press power/play/pause and Volume + simultaneously for 2 seconds. Your device will reset. - If nothing works then try connecting your psa player to the computer and then start Philips Device Manager and select "restore" to rebuild the database and firmware image of the psa player
Cannot transfer from my PSA back to my computer	This is not an error: Windows Media Player can only transfer tracks from your computer back to your PSA but not the other way round, subject to digital rights management.
Device shows "! " / "Connect to PC"	Connect your device to the computer. Use Philips Device Manager to repair your device.

Safety and Maintenance

General maintenance

To avoid damage or malfunction:

- Do not expose to excessive heat caused by heating equipment or direct sunlight.
- Do not drop your player or allow objects to fall on your player.
- Do not allow your player to be submerged in water. Do not expose earphone socket or battery compartment to water as water entering the set may cause major damage.
- Do not use any cleaning agents containing alcohol, ammonia, benzene, or abrasives as these may harm the set.
- Active mobile phones in the vicinity may cause interference.
- **Backup your files.** Please ensure that you retain the original files that you have downloaded to your device. Philips is not responsible for any loss of content if the product becomes damaged or not readable / legible.
- Manage (transfer, delete, etc.) your files only through included music software to avoid problems!

About operating and storage temperatures

- Operate in a place where the temperature is always between 0 and 35°C (32 to 95°F).
- Store in a place where the temperature is always between -20 and 45°C (-4 to 113°F).
- Battery life may shorten in low temperature conditions.

Take care when using headphones

Hearing safety

Listen at a moderate volume. Using headphones at high volume can impair your hearing. We recommend headphone no. SHJ025 for this product.

Important (for models with bypacked headphones):

Philips guarantees compliance with the maximum sound power of its audio players as determined by relevant regulatory bodies only with the original model of provided headphones. In case this one needs replacement, we recommend that you contact your retailer to order a model identical to that of the original provided by Philips.

Traffic safety

Do not use headphones while driving or cycling as you may cause an accident.

Copyright information

- All other brand and product names are trademarks of their respective companies or organizations.
- Unauthorized duplication of any recordings downloaded from the internet or made from audio CDs is a violation of copyright laws and international treaties.
- The making of unauthorized copies of copy-protected material, including computer programmes, files, broadcasts and sound recordings, may be an infringement of copyrights and constitute a criminal offence. This equipment should not be used for such purposes.

Environmental information

We have reduced the packaging to its minimum and made it easy to separate into materials: cardboard, PS, PE, PET.

Your set consists of material which can be recycled if disassembled by a specialized company. Please observe the local regulations to dispose of packaging, exhausted batteries and old equipment.

Disposal of your old product



Your product is designed and manufactured with high quality materials and components, which can be recycled and reused.

When this crossed-out wheeled bin symbol is attached to a product it means the product is covered by the European Directive 2002/96/EC.

Please inform yourself about the local separate collection system for electrical and electronic products.

Please act according to your local rules and do not dispose of your old products with your normal household waste. The correct disposal of your old product will help prevent potential negative consequences for the environment and human health.

Modifications

Modifications not authorized by the manufacturer may void user authority to operate this device.

Notice for the USA



Note:

This equipment has been tested and found to comply with the limits for a Class B digital device, pursuant to part 15 of the FCC Rules. These limits are designed to provide reasonable protection against harmful interference in a residential installation. This equipment generates, uses, and can radiate radio frequency energy and, if not installed and used in accordance with the instruction manual, may cause harmful interference to radio communications.

However, there is no guarantee that interference will not occur in a particular installation.

If this equipment does cause harmful interference to radio or television reception, which can be determined by turning the equipment off and on, the user is encouraged to try to correct the interference by one or more of the following measures:

- Relocate the receiving antenna.
- Increase the separation between the equipment and receiver.
- Connect the equipment into an outlet on a circuit different from that to which the receiver is connected.
- Consult the dealer or an experienced radio/TV technician for help.

Notice for Canada

This Class B digital apparatus complies with Canadian ICES-003.

The set complies with the FCC-Rules, Part 15 and with 21 CFR 1040.10.

Operation is subject to the following two conditions:

1. This device may not cause harmful interference, and
2. This device must accept any interference received, including interference that may cause undesired operation.

Notice for the European Union

This product complies with the radio interference requirements of the European Union.

Technical Data

Power supply

610 mAh Li-ion internal rechargeable battery
Multi-voltage charger / adaptor: 4 hours full charge; 1 hour fast charge
Rechargeable batteries have a limited number of charge cycles and may eventually need to be replaced. Battery life and number of charge cycles vary by use and settings

Picture / Display

Blue backlight LCD, 96 x 64 pixels

Sound

Bass enhancement	Digital Bass boost
Channel separation	50 dB
Equalizer	customizable
Equalizer settings	Rock / R&B / Electronica / Hip Hop / Classical / Jazz
Frequency response	30-18 000 Hz
Signal to noise ratio	>80 dB
Output Power (RMS)	2 x 4 mW

Audio Playback

Compression format

MP3
(8-320 kbps and VBR; Sample rate: 8, 11.025, 16, 22.050, 24, 32, 44.1, 48 kHz)
WMA (5-192 kbps)
WMDRM

DRM

ID3-tag support

Album title and artist name

Storage Media

Built-in memory capacity

PSA610 3 GB* micro hdd
PSA612 4 GB* micro hdd
PSA615 6 GB* micro hdd

Tuner / Reception / Transmission

Auto store / Tuner band: FM***

***FM radio is only available to some regional versions. FM radio is currently not available in Europe.

Connectivity

Headphone 3.5 mm, USB

Music transfer

via Windows Media Player 10

Data transfer

via Windows Explorer (note: Windows XP users only - music transferred via Windows Explorer to "media" folder will playback)

System Requirements

Windows XP(SP1 or above)

Internet connection

Microsoft Internet Explorer 6.0 or later

USB port

This product is protected by certain intellectual property rights of Microsoft Corporation. Use or distribution of such technology outside this product is prohibited without a license from Microsoft or an authorized Microsoft subsidiary.

Content providers are using the digital rights management technology for Windows Media contained in this device ("WM-DRM") to protect the integrity of their content ("Secure Content") so that their intellectual property, including copyright, in such content is not misappropriated. This device uses WM-DRM software to play Secure Content ("WM-DRM Software"). If the security of the WM-DRM Software in this device has been compromised, owners of Secure Content ("Secure Content Owners") may request that Microsoft revoke the WM-DRM Software's right to acquire new licenses to copy, display and/or play Secure Content. Revocation does not alter the WM-DRM Software's ability to play unprotected content. A list of revoked WM-DRM Software is sent to your device whenever you download a license for Secure Content from the Internet or from a PC. Microsoft may, in conjunction with such licenses, also download revocations lists onto your device on behalf of Secure Content Owners.

Philips reserves the right to make design and specification changes for product improvement without prior notice.

*Note that some operating systems display capacity in units of "GB" where 1.0 GB = 2^{30} = 1,073,741,834 bytes.
1 GB=1 billion bytes; actual formatted capacity less.

About Philips Device Manager



With Philips Device Manager, you can update and repair your device with a few simple clicks.

About Windows Media Player

With Windows Media Player you can easily manage your digital music collection and transfer music to your device.

Note:

Music that has not been transferred to your device using Windows Media Player can not be played on your device.

Install Windows Media Player and Device Manager

- ① Insert the supplied CD into your computer's CD-ROM drive.
- ② Follow screen instructions to begin and complete installation.
- ③ Install Windows Media Player.
- ④ Fill in necessary information when prompted to do so.

Windows Media Player 10

- ① Connect your device to your computer using the supplied USB cable.
The USB connection screen will automatically appear.



TIP

Please refer to your computer's manual for the exact position of your USB port.
Look for the USB symbol on the processing unit of your computer.

- ② Launch Windows Media Player.

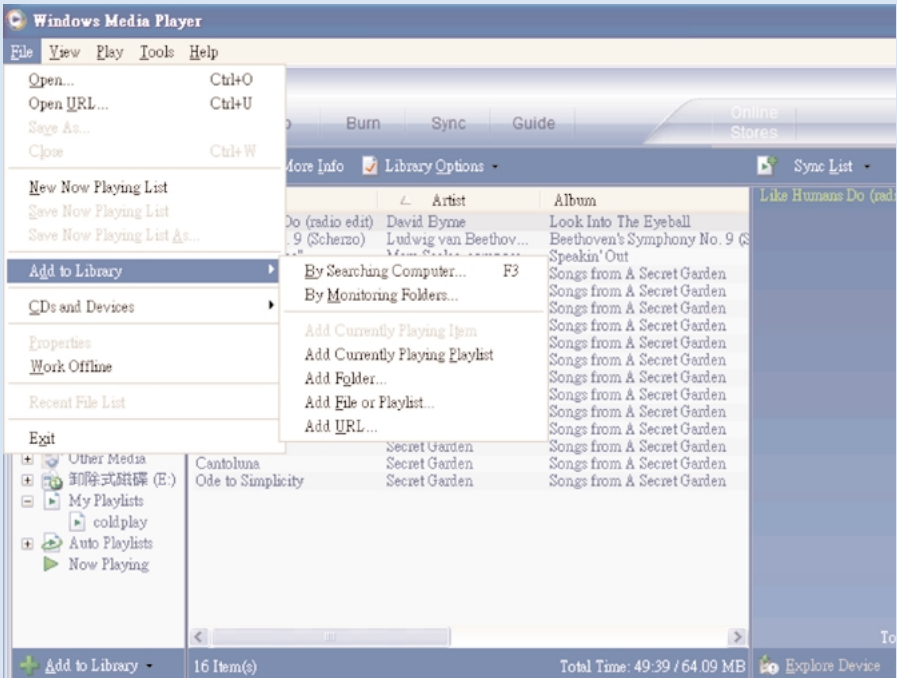

*Actual display varies with use.

Search and add tracks to the Library

- ① Go to File menu. Click Add to Library > By Searching Computer.
- ② Click Browse in the dialog box to point to the folder you want to add to.
- ③ Complete the information in the dialog box, and then click Search.
- ④ Files will be added to the Library.

- 3 In the Items on Device pane, show the device that you want to copy files to, i.e. GoGear Audio / Philips GoGear. Clear the check boxes next to any files you do not want to copy:

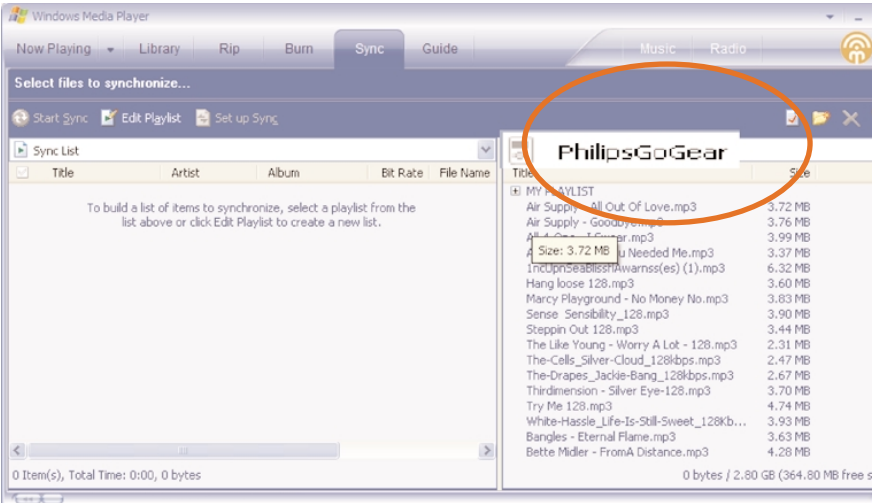

- 4 Click the Start Sync button 

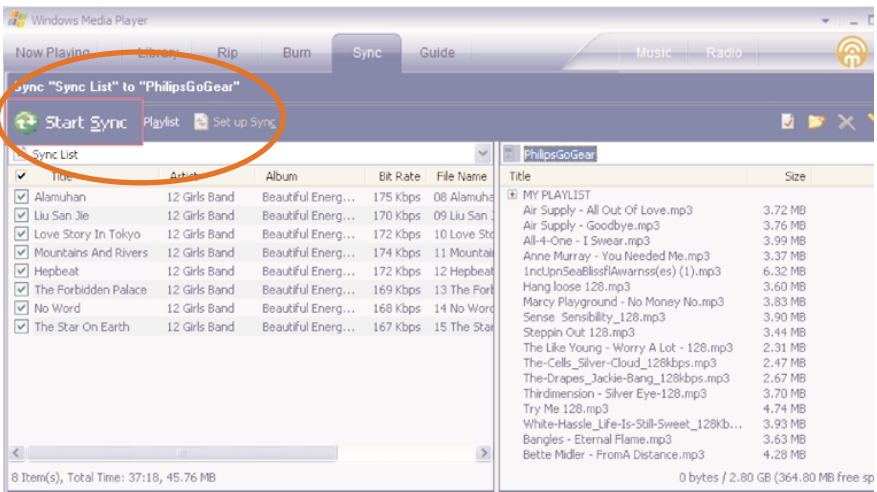

TIP

For further details of music transfer on WMP 10, go to the help section of Windows Media Player and click **Help > Synchronizing content to devices**.

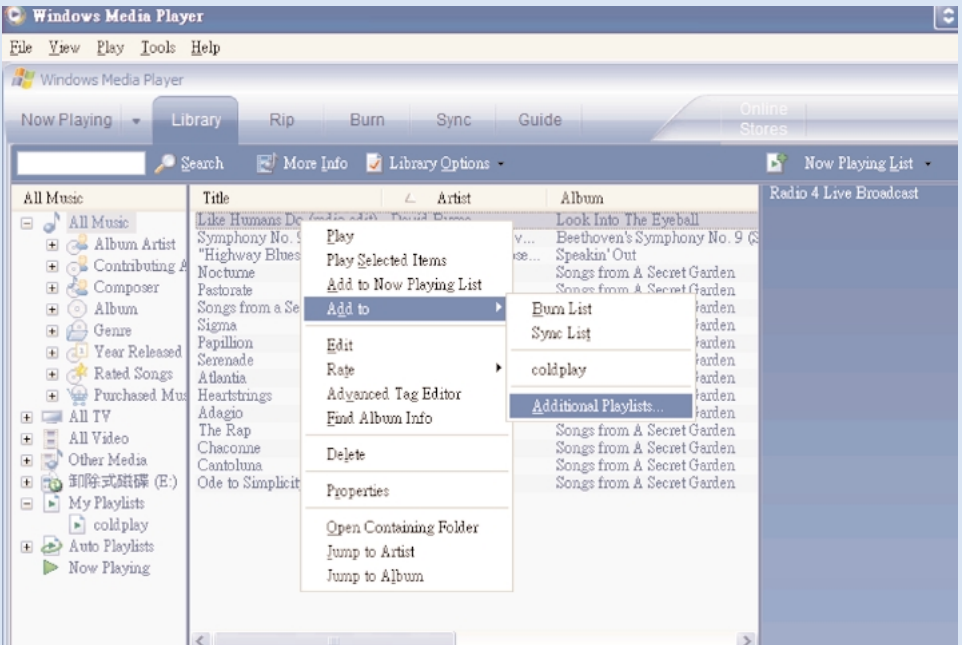

*Actual display varies with use.

Add Tracks to a Playlist on your PC using WMP

- ① Click to highlight an item.
- ② Right click on the item and select Add to > Additional Playlist.
- ③ From the Add to Playlist pop-up window, select an existing playlist or add new one.
- ④ The selection is added to playlist.



TIP

Press and hold <Ctrl> on your keyboard and click to select more than one item. To select consecutive items, click the first item, press and hold <Shift> on your keyboard, and then click the last item.

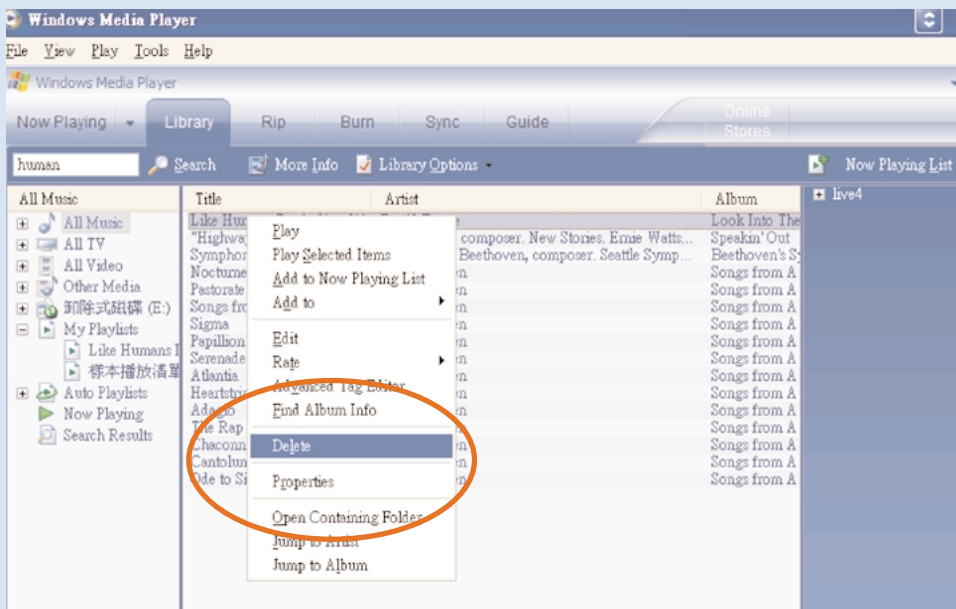

*Actual display varies with use.

Delete Tracks and Playlists

- 1 Click to highlight an item.
- 2 Right click and select Delete to delete.



TIP

Press and hold <Ctrl> on your keyboard and click to select more than one item. To select consecutive items, click the first item, press and hold <Shift> on your keyboard, and then click the last item.

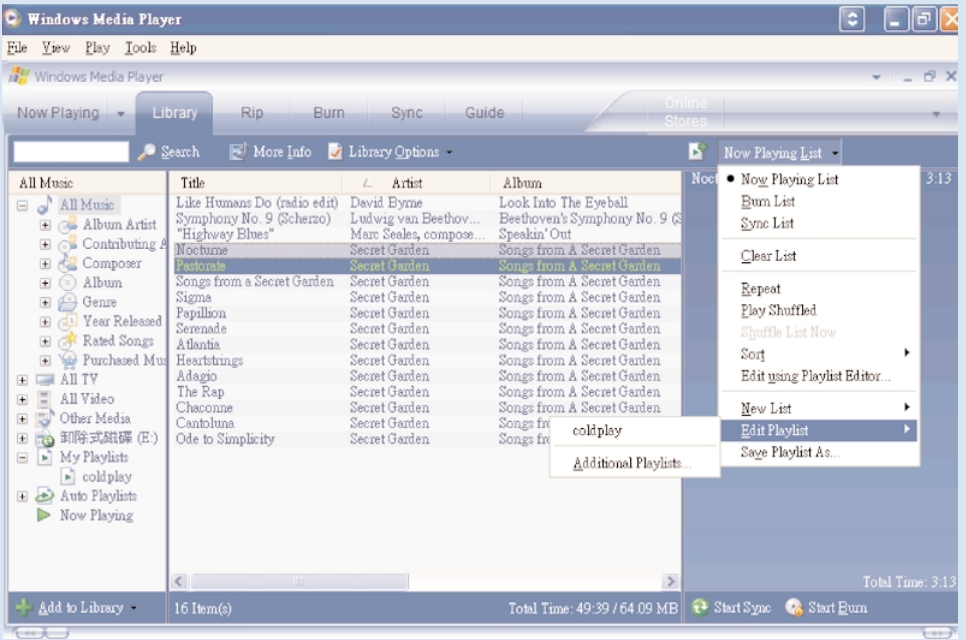

*Actual display varies with use.

Edit Track Information

- ① Click on a track.
- ② Right click and select Edit.
- ③ Click on the text boxes to edit relevant information.

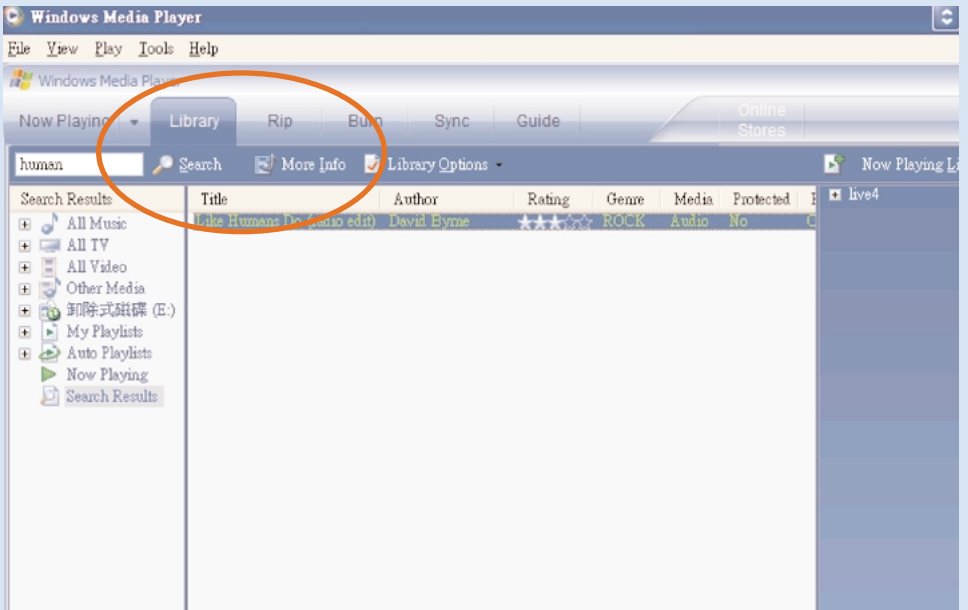

*Actual display varies with use.

Search for Tracks

- ① Type a search string in the Search field.
- ② Click on Search to start searching.
- ③ You will see tracks that contain the search string.
- ④ You can play, transfer, delete or add these tracks.

Update and repair with Philips Device Manager

Upgrades

We know you will enjoy your product for a long time. For best performance, we recommend that you regularly check in to www.philips.com for free upgrades of the latest software and firmware for your product.

If your:

- internet connection is activated
- your Device Manager has been installed on your PC
- your device is connected and powered on

then your Device manager will pop-up a message if new firmware is available for your device

Firmware Update

Your device is controlled by an internal program called firmware. You can install the latest firmware from the bypacked CD and download it from www.philips.com/support to keep your device updated.



TIP Please charge your device fully before firmware upgrade. This will ensure steady power supply for completing the whole process.

- 1 Install the latest Philips Device Manager from the bypacked CD. Philips Device Manager will automatically notify you if any new updates are available.
- 2 Connect your device to your computer (powered by the supplied AC/DC adapter if applicable).
- 3 Launch **Device Manager** User Interface by right-clicking on this  icon in the taskbar and selecting "Launch Device Manager" or from the Desktop icons or by going to **Start → Programs → Philips Device Manager →** or from the desktop.
- 4 Select your device and click Upgrade, Device Manager will check whether a new firmware is available and install it on your device.
- 5 If a new firmware file is available for your device, you will be prompted to download the same. You can choose "**Yes**" to download the latest firmware or choose "**Cancel**" to use the existing firmware file on your PC.
- 6 If you have chosen to download the latest firmware, after the download, the Device Manager will prompt you for permission to load the firmware onto the device. On selecting "**Yes**" the latest firmware will be loaded into the device.
- 7 In case you have chosen "**Cancel**", the firmware present on the PC will be loaded onto the device.
- 8 The process is complete when the device restarts and displays the power up splash screen. A success message will be displayed to you.

Device Repair

Your device is controlled by an internal program called firmware. In case your device has a problem, or you wish to format the device, you may need to repair it.



TIP

Please charge your device fully before device repair. This will ensure steady power supply for completing the whole process.

- ① Connect your device to your computer (powered by the supplied AC/DC adapter if applicable).
- ② Launch Device Manager User Interface by right-clicking on this  icon in the taskbar and selecting "Launch Device Manager" or by going to **Start → Programs → Philips Device Manager**
- ③ In the main window, go to the repair tab and click Repair.
- ④ You will be prompted before repair begins.

ATTENTION!

All media contents will be erased!

- ⑤ Click OK to continue. Click Cancel to stop.
- ⑥ The Device Manager will repair your device. Once the repair is complete, the device can be used again.

Your device will be automatically disconnected as soon as Device Manager finishes interacting with your device and will get connected back to the PC after the repair is complete.



 Be responsible
Respect copyrights

Specifications are subject to change without notice.
Trademarks are the property of Koninklijke Philips Electronics N.V.
or their respective owners
2005 © Koninklijke Philips Electronics N.V. All rights reserved.

www.philips.com

