

Canon EF LENS

EF8-15mm f/4L Fisheye USM



 **ULTRASONIC**

ENG
Instruction

Thank you for purchasing a Canon product.

The Canon EF8-15mm f/4L Fisheye USM lens is a high-performance fisheye zoom lens designed for use with Canon EOS cameras.

Features

1. Designed for use with three different image sensor sizes.
 2. Aspherical and UD lens elements result in outstanding image delineation.
 3. SWC (Subwavelength Structure Coating) is utilized to significantly reduce occurrences of flare and ghost created by quite large incident angles of light.
 4. A fluorine coating has been applied to the lens's front and rear lens elements which allows dust to be wiped from the outside of the lens more easily compared with previous lenses.
 5. Ultrasonic motor (USM) for quick and quiet autofocusing.
 6. Manual focusing is available after the subject comes into focus in autofocus mode (ONE SHOT AF).
 7. A truly round aperture hole results in a nicer background blur.
 8. Equipped with a zoom limiter function which restricts the zoom range.
 9. Tight seal structure ensures excellent dust-proof and drip-proof performance.
- "USM" stands for Ultrasonic Motor.

Conventions used in this instruction



Warning to prevent lens or camera malfunction or damage.



Supplementary notes on using the lens and taking pictures.

Safety Precautions

Safety Precautions

- **Do not look at the sun or a bright light source through the lens or camera.** Doing so could result in loss of vision. Looking at the sun directly through the lens is especially hazardous.
- **Whether it is attached to the camera or not, do not leave the lens under the sun without the lens cap attached.** This is to prevent the lens from concentrating the sun's rays, which could cause a fire.

Handling Cautions

- **If the lens is taken from a cold environment into a warm one, condensation may develop on the lens surface and internal parts.** To prevent condensation in this case, first put the lens into an airtight plastic bag before taking it from a cold to warm environment. Then take out the lens after it has warmed gradually. Do the same when taking the lens from a warm environment into a cold one.
- Do not leave the lens in excessive heat such as in a car in direct sunlight. **High temperatures can cause the lens to malfunction.**

This device complies with Part 15 of the FCC Rules. Operation is subject to the following two conditions: (1) This device may not cause harmful interference, and (2) this device must accept any interference received, including interference that may cause undesired operation.

Do not make any changes or modifications to the equipment unless otherwise specified in the instructions. If such changes or modifications should be made, you could be required to stop operation of the equipment.

This equipment has been tested and found to comply with the limits for a class B digital device, pursuant to part 15 of the FCC Rules. These limits are designed to provide reasonable protection against harmful interference in a residential installation. This equipment generates, uses and can radiate radio frequency energy and, if not installed and used in accordance with the instructions, may cause harmful interference to radio communications.

However, there is no guarantee that interference will not occur in a particular installation. If this equipment does cause harmful interference to radio or television reception, which can be determined by turning the equipment off and on, the user is encouraged to try to correct the interference by one or more of the following measures:

- Reorient or relocate the receiving antenna.
- Increase the separation between the equipment and receiver.
- Consult the dealer or an experienced radio/TV technician for help.

This Class B digital apparatus complies with Canadian ICES-003.

Precautions for Shooting with a Fisheye Lens

- If dirt or dust adheres to the surface of the front lens element, it can easily appear in images due to the lens's short focal length. In order to avoid this, please remove dirt or dust from the surface of the front lens element by using a commercially available air dust blower.
- Since this lens has an extremely wide angle of view, light from bright light sources, such as the sun, can easily enter the image area. Please do not look at bright light sources using the camera's viewfinder.
- Depending on shooting conditions, flare and ghost will occur when bright light sources appear in the image area. In order to prevent flare and ghost, we suggest shooting places such as shaded areas so that bright light does not enter the lens.
- Unintentional photographing of the user's body can easily occur during handheld shooting. Likewise, the legs of a tripod can be unintentionally photographed when a tripod is used. In addition, due to the optical characteristics of this lens, unintentional photographing of objects can easily occur since the angle of view exceeds 180° in the close-up shooting range. Therefore, please use the camera's viewfinder or LCD display to carefully check the image area.
- Since this is an interchangeable lens, the center of the image circle of the circular fisheye and the center of the image sensor are out of alignment. Also, there are times when vignetting, which occurs in the four corners of an image, is not uniform.
- It is possible to use AE (Auto Exposure) even if vignetting occurs in the four corners of an image when using a circular fisheye effect, etc. However, since the angle of view is extremely wide and the luminance range of subjects is broad, we suggest changing the exposure manually when possible. Also, it is recommended that users check the image area using the LCD display when shooting with a digital camera.

Nomenclature

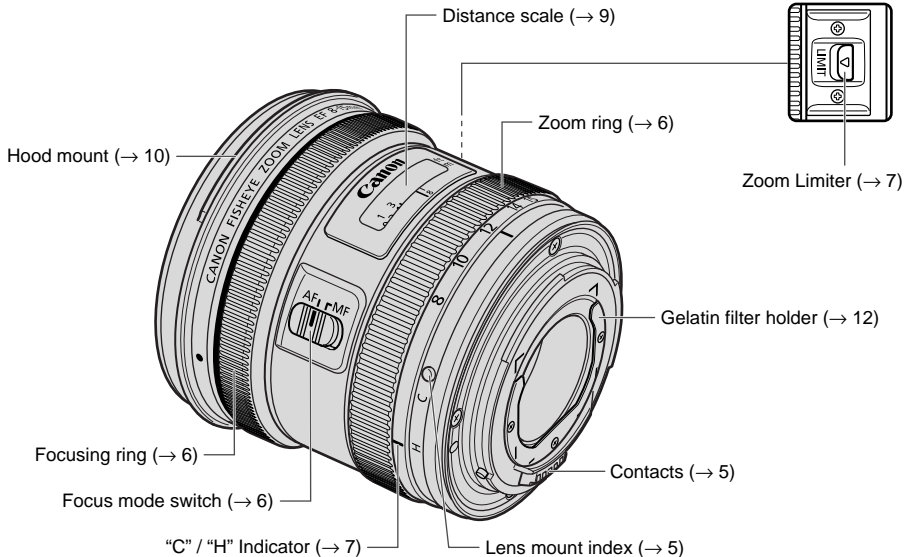

For detailed information, reference page numbers are provided in parentheses (→ **).

1. Mounting and Detaching the Lens

See your camera's instructions for instructions on mounting and detaching the lens.

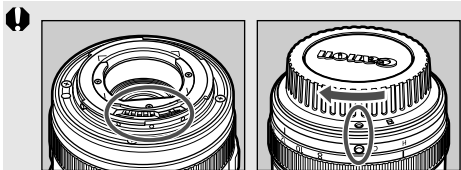

- After detaching the lens, please attach the lens hood and lens cap and place the lens with the rear end up to prevent the electrical contacts and lens surface from getting scratched.
- If the contacts get soiled, scratched, or have fingerprints on them, corrosion or faulty connections can result. The camera and lens may not operate properly.
- If the contacts get soiled or have fingerprints on them, clean them with a soft cloth.
- If you remove the lens, cover it with the dust cap. To attach it properly, align the lens mount index and the ○ index of the dust cap as shown in the diagram, and turn clockwise. To remove it, reverse the order.

⚠ The lens mount has a rubber ring for enhanced water- and dust-resistance. The rubber ring may cause slight abrasions around the camera's lens mount, but this will not cause any problems. If the rubber ring becomes worn, it is replaceable by a Canon Service Center at cost.

⚠ Please be careful when laying the lens sideways while the lens hood and the lens cap are attached.
The lens may roll and fall, resulting in injury.

2. Setting the Focus Mode

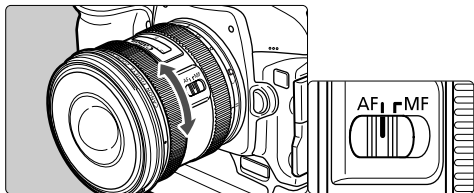

To shoot in autofocus (AF) mode, set the focus mode switch to AF.

To use only manual focusing (MF), set the focus mode switch to MF, and focus by turning the focusing ring. The focusing ring always works, regardless of the focus mode.



After autofocus in ONE SHOT AF mode, focus manually by pressing the shutter button halfway and turning the focusing ring. (Full-time manual focus)

3. Zooming

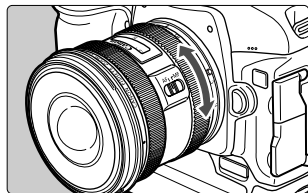

To zoom, turn the zoom ring.



Be sure to finish zooming before focusing. Changing the zoom ring after focusing can affect the focus.

Zooming

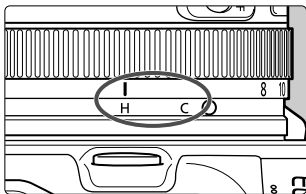

“C” and “H” Markings

Adjacent to the zoom ring, the “C” and “H” markings serve as guides to indicate the wide-angle zoom position where focus is set at infinity at which photos can be created without vignetting when using EOS digital cameras installed with APS-C or APS-H image sensors. The “C”/“H” indicator on the zoom ring is aligned with either the “C” or “H” marking.

 When the “C” / “H” indicator above the focus ring is aligned with either the “C” or “H” marking, there are times when vignetting occurs in the corners of an image since the size of the image circle becomes smaller when the focus position is set at close range due to the optical characteristics of this lens.

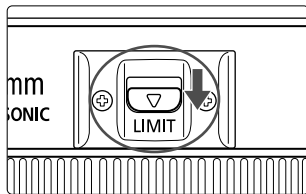

Zoom Limiter

The zoom limiter function allows for wide-angle photos to be created when focus is set at infinity without vignetting when using an EOS digital camera installed with an APS-C image sensor by limiting the zoom range. Activate the zoom limiter by setting the zoom ring to between 10mm and 15mm, then slide the switch towards “LIMIT.”

 The zoom limiter cannot be used if the zoom ring is set between 8mm and about 10mm (when the “C” / “H” indicators on the zoom ring are set between the “C” indicator and the wide-angle direction on the ring next to the zoom ring).

Zooming

Description of Fisheye Lens Based Photography

The various images below show the different relationships between the fisheye lens's 180 degree angle of view and the size of each image sensor related to focal length.

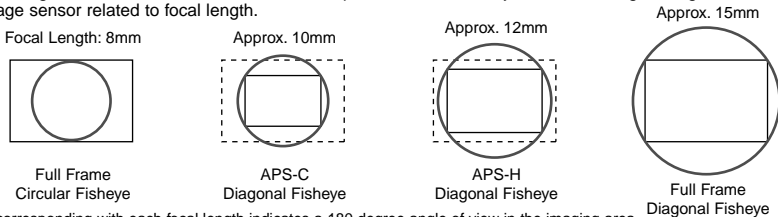

* The circle corresponding with each focal length indicates a 180 degree angle of view in the imaging area.

* Vignetting occurs in the area outside of the image circle.

• Circular Fisheye

The circular fisheye effect refers to the 180 degree circular angle of view which appears within the area of the image sensor. When the focusing distance of this particular lens is set to infinity, the circular fisheye effect is achieved by setting the focal length (wide end) to 8mm and using a camera equipped with a full frame image sensor.

• Diagonal Fisheye

The diagonal fisheye effect refers to a 180 degree diagonal angle of view which corresponds with the size of the sensor. When the focusing distance of this particular lens is set to infinity, the diagonal fisheye effect is achieved by setting the focal length (telephoto end) to 15mm when used with full frame image sensors, approximately 12mm when used with APS-H, and approximately 10mm when used with APS-C.



- Use of the zoom limiter at the lens's wide end position does not guarantee that a diagonal fisheye effect will be created when used with APS-C sensors.
- When the focusing distance is set to infinity, the angle of view when using the lens set at the telephoto end together with full frame format cameras is 175°30' (diagonal). The 180° diagonal fisheye effect is achieved by slightly turning the zoom ring toward the wide end when the lens is set at 15 mm (telephoto end).
- Due to the optical characteristics of the lens, the size of the image circle becomes smaller when the focus position is set at close range.

4. Infinity Compensation Mark

Infinity compensation mark

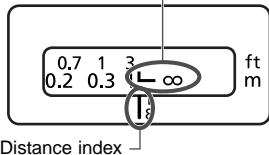

To compensate for shifting of the infinity focus point that results from changes in temperature. The infinity position at normal temperature is the point at which the vertical line of the L mark is aligned with the distance indicator on the distance scale.

 For accurate manual focusing on subjects at infinity distance, turn the focus ring while looking through the viewfinder or checking the camera's LCD display.

5. Infrared Index

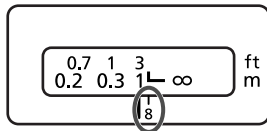

The infrared index corrects the focus setting when using monochrome infrared film. Focus on the subject manually, then adjust the distance setting by moving the focusing ring to the corresponding infrared index mark.

 Some EOS cameras cannot use infrared film. See the instructions for your EOS camera.

- 
- The infrared index position is based on a wavelength of 800 nm.
 - The compensation amount differs depending on the focal length. Use the indicated focal length as a guide when setting the compensation amount.
 - Be sure to observe the manufacturer's instructions when using infrared film.
 - Use a red filter also when you take the picture.

6. Hood

The EW-77 hood can keep unwanted light out of the lens, and also protects the front of the lens from rain, snow, and dust.

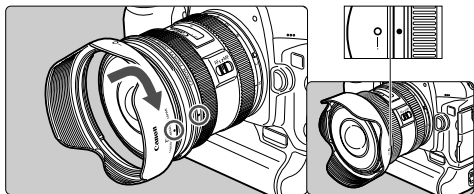

Attaching

To attach the hood, align the hood's attachment position mark with the red dot on the front of the lens, then turn the hood as shown by the arrow until the lens' red dot is aligned with the hood's stop position mark.



This hood can be used even when the lens cap is attached to it.

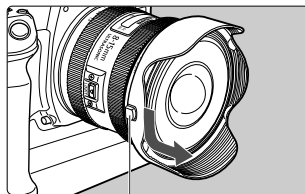

Button

Removing

To remove the hood, hold down the button on the side and turn the hood in the direction of the arrow until the position mark on the hood aligns with the red dot.

Hood

Vignetting will not occur while shooting in the following zoom ranges when using the lens hood. Please detach the lens hood when shooting outside of these ranges.

- **Full Format:** Only at the telephoto end
- **APS-H:** From the telephoto end to the “H” marking
- **APS-C:** From the telephoto end to the “C” marking (range when using the zoom limiter)



- Part of the picture may be blocked if the hood is not attached properly.
- When attaching or detaching the hood, grasp the base of the hood to turn it. To prevent deformation, do not grasp the rim of the hood to turn it.

7. Lens Cap

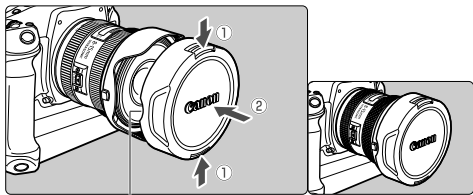

Recessed Section

While the lens hood (included) is attached to the lens, Lens Cap 8-15 can be attached to the lens hood by pressing the buttons located on the upper and lower sides of the lens cap and aligning its recessed parts with the convex parts found in the lens hood.

8. Filter (Sold separately)

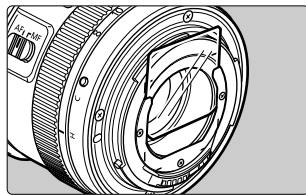

There is a gelatin filter holder at the rear of the lens. Cut the gelatin filter to fit within the white frames. Then insert the gelatin filter into the filter holder.

Specifications

Focal Length/Aperture	8 – 15 mm f/4
Lens Construction	11 groups, 14 elements
Minimum Aperture	f/22
Angle of View	Diagonal: 180° – 175° 30' Vertical: 180° – 91° 46' Horizontal: 180° – 142°
Min. Focusing Distance	0.15 m / 0.5 ft.
Max. Magnification	0.34x (center of image, telephoto end)
Max. Diameter and Length	78.5 × 83.0 mm / 3.1 × 3.3 inch
Weight	approx. 540 g / 19.0 oz.
Hood	EW-77
Lens Cap	Lens Cap 8-15
Case	LP1219

- The lens length is measured from the mount surface to the front end of the lens.
- The size and weight listed are for the lens only, except as indicated.
- The EF1.4X II, III/EF2X II, III extender, the EF12 II/EF25 II extension tube, and 250D/500D close-up lenses cannot be used with this lens.
- Aperture settings are specified on the camera.
- All data listed is measured according to Canon standards.
- Product specifications and appearance are subject to change without notice.

Canon