

CRATE®

GX-25M AMPLIFIER



OWNER'S MANUAL

Congratulations!

You are now the proud owner of the compact but powerful Crate GX-25M guitar amplifier. Two versatile channels – one crystal clear and the other with our patented “Flex-Wave” distortion – combined with reverb, a three-band EQ *and* a switchable Chorus offer you more flexibility and performance than any amp in its class. A special damping circuit simulates the “current source” type of output of a tube amp, giving you solid state reliability combined with classic tube sounds.

Like all Crate products, your GX-25M is Musician Made in the U.S.A., using only the best components. Extensive testing at the hands (and ears) of skilled technicians and musicians insures you that this amplifier is the absolute best it can be.

In order to get the most out of your new amplifier, we strongly urge you to go over the information contained in this manual before you begin playing.

And *thank you* for choosing **CRATE®**

CRATE[®] GX-25M Amplifier

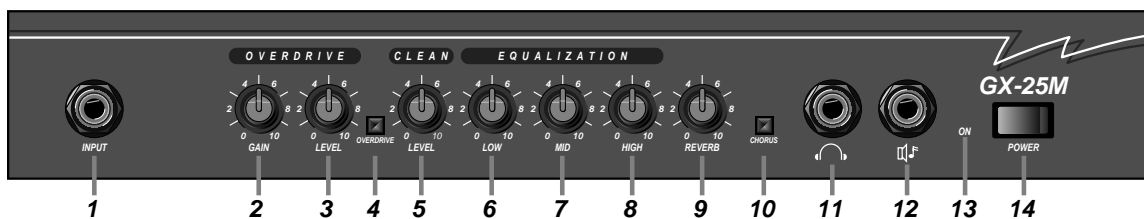

1: INPUT: Connect your guitar here using a shielded instrument cable.

OVERDRIVE CHANNEL: A high gain channel giving you sounds from a slight edge to serious overdrive.

2: GAIN: This control sets the amount of compression and distortion from the amplifier. With the control towards far left, the sound will have a thick compressed quality. As you turn the control to the right the amount of distortion increases. Crate's exclusive "Flex Wave" circuitry uses sequential cascading gains to deliver distortion which is rich in harmonics and "touch sensitive." Use this control along with the Level (#3) to create a wide variety of sounds.

3: LEVEL: This control sets the output volume level from the Overdrive channel: in the far-left position there will be no output; as you turn the control to the right the output increases. Use this control along with the Gain control (#2) to create a wide variety of sounds.

4: OVERDRIVE SELECT: When this pushbutton switch is pressed in the Overdrive channel is engaged. The clean channel is selected when this switch is out.

CLEAN CHANNEL: A normal gain channel designed to give you crystal clear sounds to medium distortion.

5: LEVEL: This control sets the output volume level from the Clean channel: in the far-left position there will be no output; as you turn the control to the right the output level increases. The far right setting is maximum output - as you increase the level, roll back the Low control (#6).

EQUALIZATION

6: LOW: Adjust the low frequency output level with this control: turning the control to the left reduces the low frequency output; turning it to the right increases the low frequency output. The Low control allows a total range of 25dB of boost or cut at 80Hz. Due to the massive amount of low end available, you may want to "roll off" the bass at high volumes.

7: MID: Adjust the mid frequency output level with this control: the center position is "flat" (no boost or cut). Turning the control to the left reduces the midrange output; turning it to the right increases the midrange output. The Mid control allows for 19dB of boost or cut at 900Hz.

8: HIGH: Adjust the high frequency output level with this control: in the center position the high frequency output will be "flat" (no boost or cut). Turning the control to the left reduces the high frequency output; turning it to the right increases the high frequency output. The High control allows a total range of 23dB of boost or cut at 5kHz.

9: REVERB: Adjust the amount of Reverb effect with this control: in its full-left position the signal will be "dry" (without any reverb). As you turn the control to the right the amount of reverberation increases.

10: CHORUS: The GX-25M features a built-in, preset Chorus effect to enhance the sound of either the Overdrive or the Clean channel. Press the Chorus switch IN to activate the effect.

11: HEADPHONES: For private practice sessions, plug a pair of stereo headphones into this jack. The internal speaker is disconnected whenever headphones are being used.

12: EXTERNAL SPEAKER: You may connect the GX-25M to an external speaker with a rated impedance of at least 4 ohms using this jack. The internal speaker is disconnected whenever an external speaker is used.

WARNING: DO NOT attempt to use headphones in the Speaker jack! Permanent hearing damage could result!

13: ON LED: The word "ON" will glow when you turn on the GX-25M, showing you that the amplifier is activated and ready to play.

14: POWER: This heavy-duty rocker-type switch is used to turn the amplifier ON in the left position, off in the right position. The ON LED (#13) works with this switch as a visual indicator.

15: POWER CORD: (Rear panel, not shown): This heavy-duty, grounded, three-wire power cord is to be plugged into ONLY a safely-wired, grounded 120 volt, 60 cycle AC power outlet. DO NOT attempt to defeat the ground connection of this cable!

CRATE[®] GX-25M Amplifier

SUGGESTED STARTING SETTINGS:

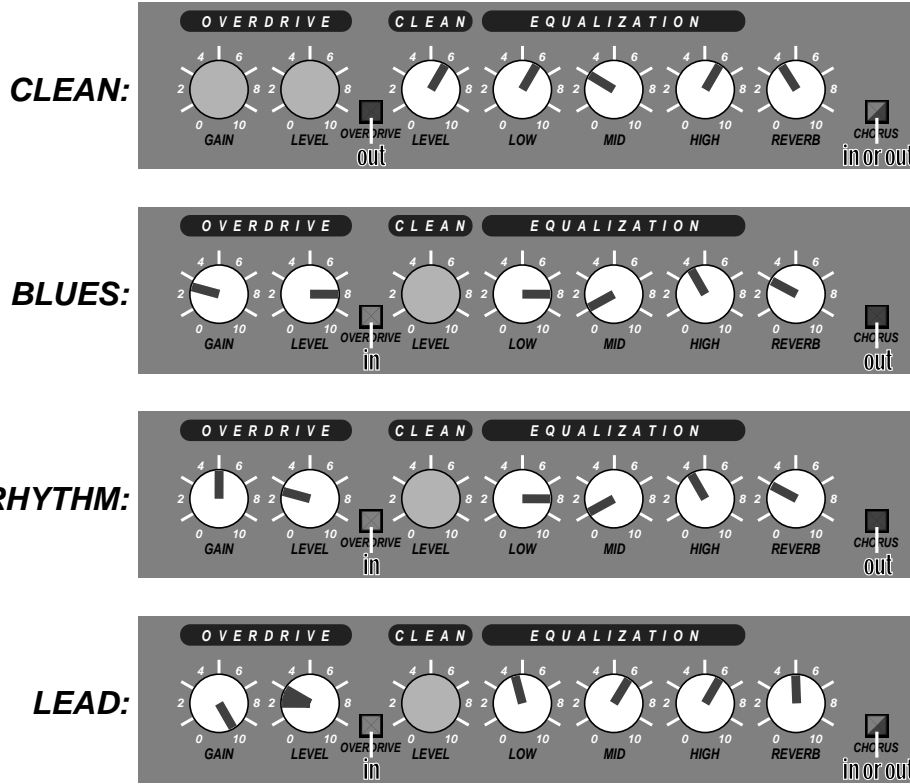

SYSTEM BLOCK DIAGRAM:

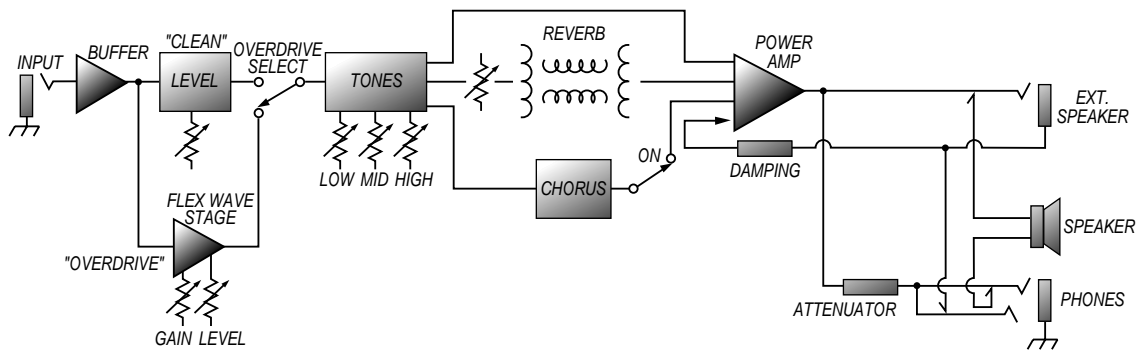

The GX-25M is covered with a durable black Tolex material.
Wipe it clean with a lint-free cloth. Never spray cleaning agents onto the cabinet.
Avoid abrasive cleansers which would damage the finish.







CRATE[®] GX-25M Amplifier



GX-25M TECHNICAL SPECIFICATIONS:

Output Power Rating	>20 watts RMS @ 5% THD 4 ohms, 120 VAC
Gain, Overdrive Channel	86 +/-6dB @ 1kHz
Gain, Clean Channel	46 +/-6dB @ 1kHz
Tone Control Range, Low	25dB @ 80Hz
Tone Control Range, Mid	19dB @ 900Hz
Tone Control Range, High	23dB @ 5kHz
Signal To Noise, Overdrive Channel	>50dB
Signal To Noise, Clean Channel	>65dB
Maximum Signal Accepted	>1.2 volts RMS min. @ 400Hz
Internal Speaker	10" Crate Custom Design 4 ohm
Power Requirements	120 VAC, 60Hz, 50 watts max.
Size and Weight	16" H x 15-3/4" W x 9" D, 19 lbs.

Crate continually develops new products, as well as improves existing ones. For this reason, the specifications and information in this Crate manual are subject to change without notice.

 <p>CAUTION RISK OF ELECTRIC SHOCK DO NOT OPEN</p> <p>CAUTION: TO REDUCE THE RISK OF ELECTRIC SHOCK, DO NOT REMOVE COVER. NO USER-SERVICEABLE PARTS INSIDE. REFER SERVICING TO QUALIFIED SERVICE PERSONNEL.</p>	<p>THIS EQUIPMENT HAS BEEN DESIGNED AND ENGINEERED TO PROVIDE SAFE AND RELIABLE OPERATION. IN ORDER TO PROLONG THE LIFE OF THE UNIT AND PREVENT ACCIDENTAL DAMAGES OR INJURY, PLEASE FOLLOW THESE PRECAUTIONARY GUIDELINES:</p>	<p>ESTE APARATO HA SIDO DISEÑADO Y CONSTRUÍDO PARA PROVEER AÑOS DE OPERACION SEGURA Y CONFIABLE. PARA PROLONGAR LA VIDA DE ESTA UNIDAD E IMPEDIR DANOS ACCIDENTALES POR FAVOR SIGA ESTAS INSTRUCCIONES PREVENTIVAS:</p>	<p>CET ÉQUIPEMENT AVAIT ÉTÉ INVENTÉ ET ARRANGÉ POUR POURVOIR DES ANNÉES D'USAGE SAUF ET SUR. POUR PROLONGER LA VIE DE CET APPAREIL ET POUR EMPÊCHER LES DOMMAGES ET LES TORTS ACCIDENTELS, SUIVEZ LES INSTRUCTIONS DE PRÉCAUTION.</p>
 <p>PRECAUCION RIESGO DE CORRIENTAZO NO ABRA</p> <p>PRECAUCION PARA DISMINUIR EL RIESGO DE CORRIENTAZO NO ABRA LA CUBIERTA. NO HAY PIEZAS ADENTRO QUE EL USUARIO PUEDO REPARAR. DEJE TODO MANTENIMIENTO A LOS TECNICOS CALIFICADOS.</p>	<p>CAUTION: TO REDUCE THE RISK OF ELECTRIC SHOCK, DO NOT OPEN CHASSIS; DO NOT DEFEAT OR REMOVE THE GROUND PIN OF THE POWER CORD; CONNECT ONLY TO A PROPERLY GROUNDED AC POWER OUTLET.</p>	<p>PRECAUCION: PARA DISMINUIR EL RIESGO DE DESCARGAS ELECTRICAS: (1) NO ABRA LA CUBIERTA. (2) NO ES RECOMENDABLE REMOVER O DESACTIVAR LA PATA DEL POLO A TIERRA DEL CABLE DE CORRIENTE, CONECTE CORRECTAMENTE A UNA TOMA DE CORRIENTE A TIERRA.</p>	<p>AVERTISSEMENT: POUR RÉDUIRE LES RISQUES D'ÉLECTROCUTION: (1) N'OUVREZ PAS LE CHÂSSIS. (2) NE PAS ESSAYER DE SUPPRIMER LA BROCHE CORRESPONDANT À LA TERRE.</p>
 <p>ATTENTION RISQUE D'ELECTROCUTION NE PAS OUVRIR</p> <p>ATTENTION: POUR REDUIRE D'ELECTROCUTION NE PAS ENLEVER LE COUVERCLE. AUCUNE PIECE INTERNE N'EST REPRABLE PAR L'UTILISATEUR. POUR TOUTE REPARATION, S'ADRESSER A UN TECHNICIEN QUALIFIE.</p>	<p>WARNING: TO REDUCE THE RISK OF FIRE OR ELECTRIC SHOCK, DO NOT EXPOSE THIS EQUIPMENT TO RAIN OR MOISTURE.</p>	<p>ADVERTENCIA: PARA EVITAR DESCARGAS ELECTRICAS O PELIGRO DE INCENDIO, NO DEJE ESTE APARATO EXPUESTO A LA LLUVIA O HUMEDAD.</p>	<p>ATTENTION: IL N'Y A PAS D'ÉLÉMENTS RÉPARABLES DANS L'APPAREIL. CONSULTEZ UN TECHNICIEN QUALIFIÉ POUR LES RÉPARATIONS.</p>
 <p>VORSICHT ELEKTRISCHE SCHLAGGEFAHR NICHT OFFENEN</p> <p>VORSICHT: ZUR MINIMIERUNG ELEKTRISCHER SCHLAGGEFAHR NICHT DEN DECKEL ABENHMEN. INTERNE TEILE KONNEN NICHT VOM BENUTZER GEWARTET WERDEN. DIE WARTUNG IS QUALIFIZIERTEM WARTUNGSPERSONAL ZU UBERLASSEN.</p>	<p>CAUTION: NO USER-SERVICEABLE PARTS INSIDE. REFER SERVICING TO QUALIFIED SERVICE PERSONNEL.</p> <p>CAUTION: OUR AMPLIFIERS ARE CAPABLE OF PRODUCING HIGH SOUND PRESSURE LEVELS. CONTINUED EXPOSURE TO HIGH SOUND PRESSURE LEVELS CAN CAUSE PERMANENT HEARING IMPAIRMENT OR LOSS. USER CAUTION IS ADVISED AND EAR PROTECTION IS RECOMMENDED IF UNIT IS OPERATED AT HIGH VOLUME.</p>	<p>PRECAUCION: NO HAY PIEZAS ADENTRO QUE EL USUARIO PUEDE REPARAR. DEJE TODO MANTENIMIENTO A LOS TECNICOS CALIFICADOS.</p> <p>PRECAUCION: NUESTROS AMPLIFICADORES PUEDEN PRODUCIR NIVELES DE PRESION DE SONIDO ALTO. EXPOSICION CONTINUADA A LOS NIVELES DE PRESION DE SONIDO ALTO PUEDE CAUSAR DAÑO PERMANENTE A SU OIDO. ES ACONSEJADO QUE USE PRECAUCION AL USUARIO Y ES RECOMENDADO PROTECCION PARA LOS OIDOS SI LA UNIDAD ES OPERADA A VOLUMEN ALTO.</p>	<p>ATTENTION: NOS AMPLIFICATEURS SONT CAPABLES DE LA PRODUCTION DES NIVEAUX DE SON D'UNE HAUTE PRESSION. L'EXPOSITION CONTINUE AUX CES NIVEAUX PEUT CAUSER LA SURDITE PERMANENTE. LA PRUDENCE EST ADVISÉ À UTILISATEUR ET LA PROTECTION DES OREILLES EST RECOMMANDÉ SI L'APPAREIL EST UTILISÉ À UN HAUT NIVEAU DE VOLUME.</p>
<p>EXPLANATION OF GRAPHICAL SYMBOLS: EXPLICACION DE SIMBOLOS GRAFICOS: EXPLICATION DES SYMBOLES GRAPHIQUES:</p>	 = "DANGEROUS VOLTAGE" "VOLTAJE PELIGROSO" "DANGER HAUTE TENSION" "GEFAHLICHE SPANNUNG"	 = "IT IS NECESSARY FOR THE USER TO REFER TO THE INSTRUCTION MANUAL" "ES NECESARIO QUE EL USUARIO SE REFIERA AL MANUAL DE INSTRUCCIONES" "REFERREZ-VOUS AU MANUAL D'UTILISATION" "UNBEDINGT IN DER BEDIENUNGSANLEITUNG NACHSCHLAGEN"	

