

ASM10AK

GE® ENERGY STAR® Deluxe 115 Volt Electronic Room Air Conditioner

Wall Case Dimensions and Installation Information (in inches)

Note: When installing slide-out chassis units in through-the-wall applications, keep louvers free. Do not restrict air flow areas. Fixed chassis units are not suitable for through-the-wall applications.

Wall Outlets: All wiring including installation of receptacle must be made in accordance with local electrical codes and regulations. Electrical outlet should be in reach of line cord.

Note: Aluminum wiring may pose special problems – consult a qualified electrician.

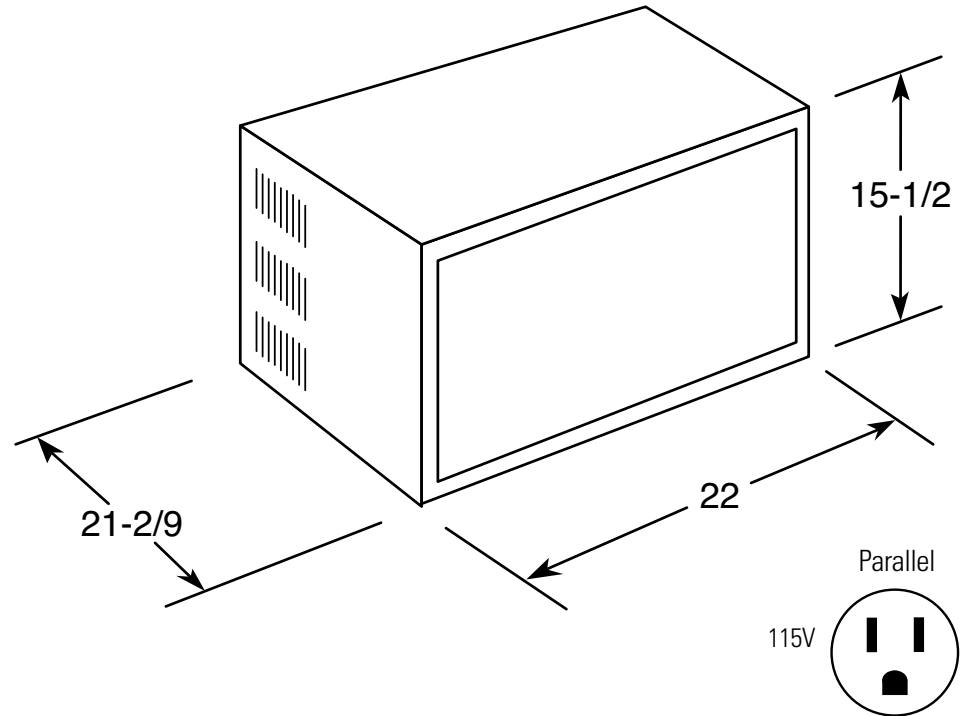

For answers to your Monogram®, GE Profile™ or GE® appliance questions, visit our website at ge.com or call GE Answer Center® service, 800.626.2000.



imagination at work



Total volume and shelf area are calculated by the Association of Home Appliance Manufacturers' standards.



Listed by Underwriters Laboratories



As an ENERGY STAR® partner, GE has determined that this product meets the ENERGY STAR guidelines for energy efficiency.

ASM10AK

GE® ENERGY STAR® Deluxe 115 Volt Electronic Room Air Conditioner

Features and Benefits

- 10,500 Cooling BTUH
- 10.8 EER
- 2.5 Dehumidification (pints/hr)
- 115 Volts
- Delay timer (24-hour)
- 3 Cooling / 3 Fan Only Speeds
- Electronic Digital Thermostat with Remote
- Model ASM10AK

