

Operating Instructions

Industrial CCD Camera
GP-MS112

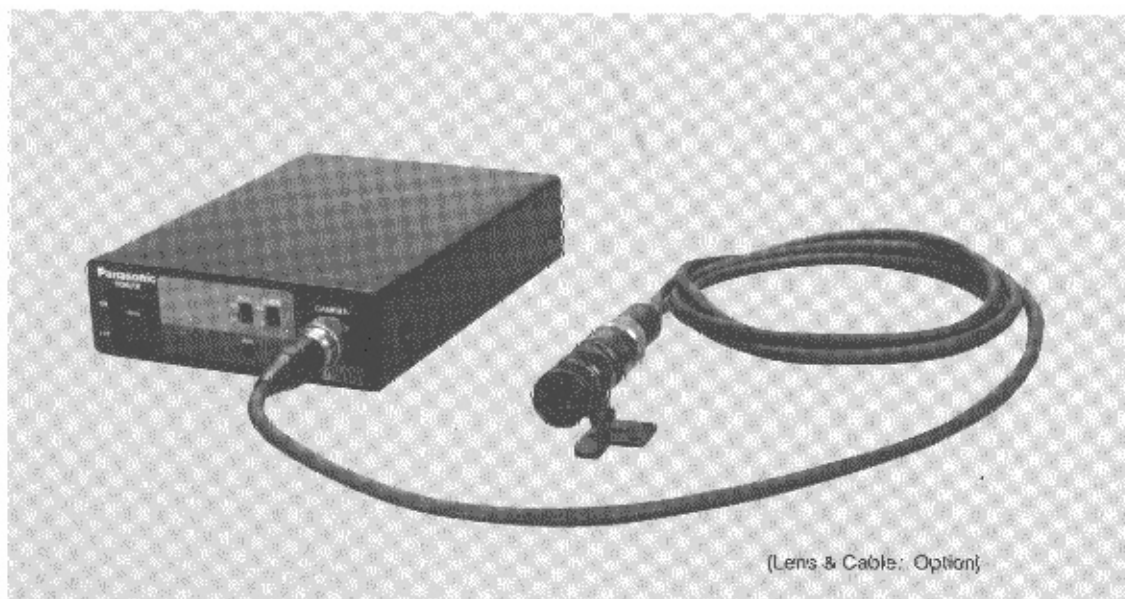

Panasonic[®]

Before attempting to connect or operate this product, please read these instructions completely.

PREFACE

The Panasonic GP-MS112 CCD Micro-Camera overcomes space limitations that have complicated many video applications. Weighing only 0.04 lbs (16g), this remarkably compact CCTV camera measures only two-thirds of an inch in diameter and less than two inches in length. It can easily be separated from its control unit and extended up to 99-feet (30-meters) away, using an optional 99-foot (30-meters) cable (GP-CA49). So the exceptionally maneuverable GP-MS112 lets you obtain a whole new world of camera angles and shots that were once quite difficult to achieve.

With the 330,000-element, 1/2-inch CCD pick-up device, horizontal resolution is more than 500 lines, and signal-to-noise ratio is 46 dB. An AGC Selection Switch and Gain Selection Switch, lets you obtain clear, high-quality images in light as low as 0.07 footcandle (0.7 lux). In addition, a small diameter wide-angle lens developed by Matsushita makes high resolution standard even with subjects as close as 4/5th of an inch away.

In addition, the camera head can be used with most existing camera systems. And the versatile GP-MS112 can be connected to a timelapse VTR, video printer or floppy disk recorder, for a host of new and traditional applications.

FEATURES

1. 1/2 inch Interline CCD image sensor with 682(H) x 492(V) pixels.
2. 500 lines of horizontal resolution.
3. 0.07 footcandle (0.7 lux) of minimum scene illumination.
4. 46 dB of signal to noise ratio.
5. Gen-lock capability.
6. Automatic gain control (AGC) ON/OFF and sensitivity up of (+6 dB) ON/OFF.
7. DC 12V operation.
8. Optional Super Wide-Angle Lens, Pinhole Lens or Telephoto-Lens can be used.
9. Optional C-mount lens can be used with optional C-mount adaptor.
10. 99 feet (30 meters) of maximum cable length between camera head and camera control unit with optional camera cable.

PRECAUTIONS

- Do not attempt to disassemble the camera.
To prevent electric shock, do not remove screws or cover. There are no user-serviceable parts inside. Refer servicing to qualified service personnel.
- Do not expose the camera or camera control unit to rain or moisture, or try to operate it in wet areas.
Do take immediate action if ever the camera or camera control unit do become wet. Turn power off and refer servicing to qualified service personnel.
Moisture can damage the camera and camera control unit and also create the danger of electric shock.
- Ambient Temperature range.
Do not install the camera in the place which is beyond 14°F - 104°F (-10°C - +40°C).
- Do not drop anything inside the camera.
Dropping metal for example inside the camera could permanently damage the unit.
- Never crush or pinch the camera cable.
Do not bend the camera cable into a curve whose radius is too small.
- Never face the camera toward the sun.
Whether the camera is in use or not, never face it toward the sun.
Do use caution when operating the camera in the vicinity of spot lights or other bright lights and light reflecting objects.
- How to take care of this camera.
After turning OFF the power ON/OFF switch, clean it with a dry cloth. If it is difficult to remove the dirt or dusts, clean it up with a cloth applied the neutral cleanser.
Use the lens cleaning tissue paper (may be available at your local camera store) for lens cleaning.
- Connect this to a DC 12V, 0.5A - 0.7A CLASS 2 Power Supply only.
- After using the camera, turn OFF the power ON/OFF switch and put the Lens cap on the camera head.
- Connect the camera head and camera control unit which are packed in the same box (a pair). Otherwise it would cause a improper operation.
- Every necessary procedures with regard to install this product should be made by qualified Service Personnel or System Installers.

Caution:

Connecting or disconnecting camera cable to/from the camera control unit must be done after turning OFF the Power ON/OFF switch.

SYSTEM BLOCK DIAGRAM

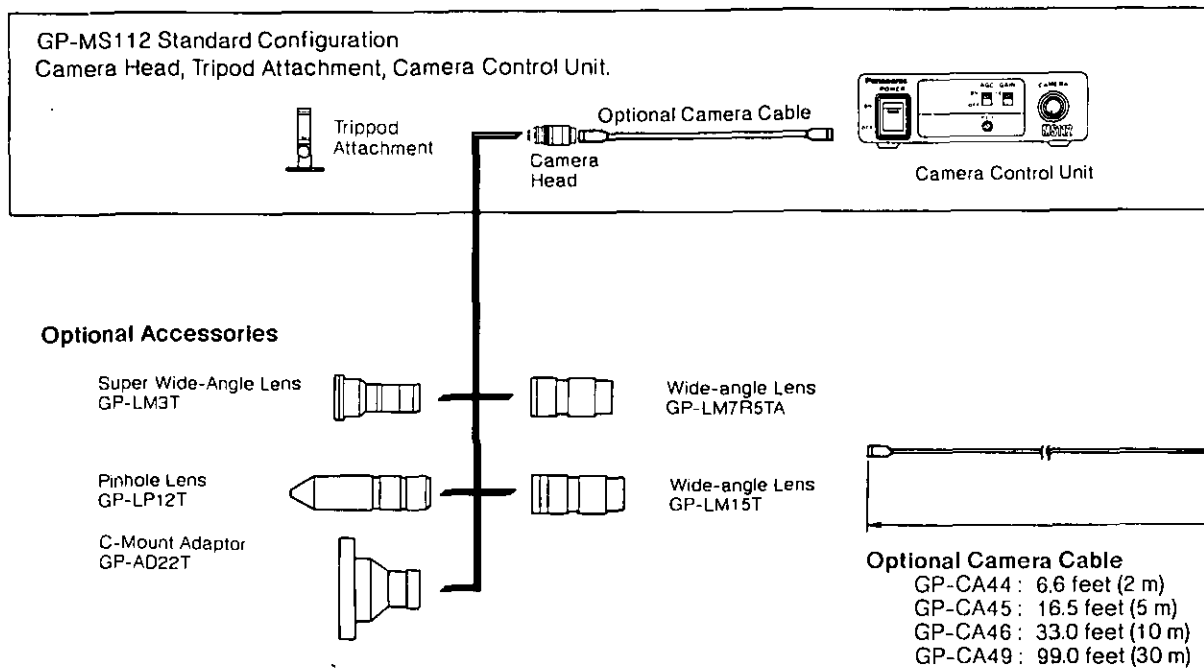

MAJOR OPERATING CONTROLS AND THEIR FUNCTIONS

GP-MS112

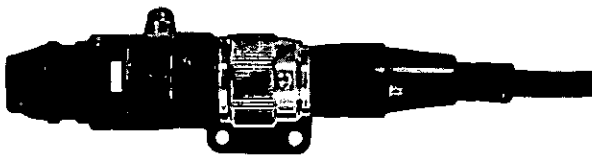

GP-MS112 with GP-LM3T

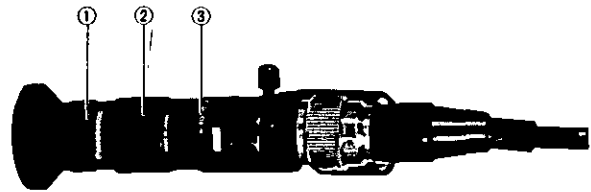

GP-MS112 with GP-LP12T

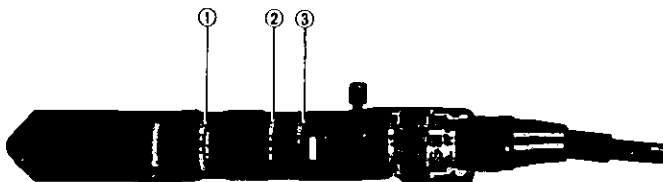

GP-MS112 with GP-AD22 and optional C-mount Lens

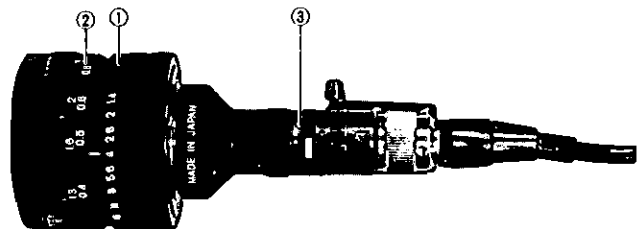

GP-MS112 with GP-LM15T

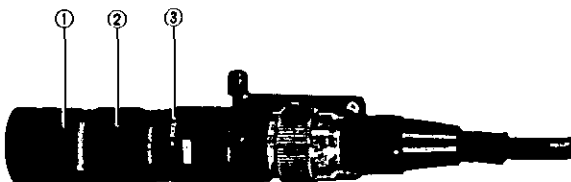

GP-MS112 with GP-LM7R5TA

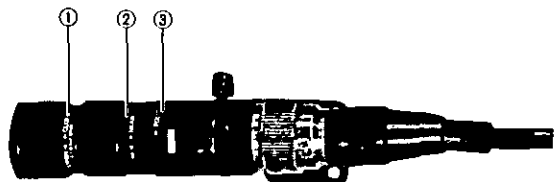

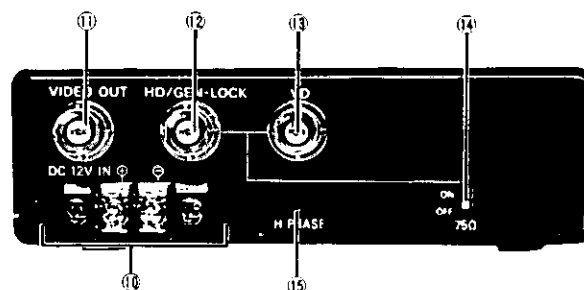
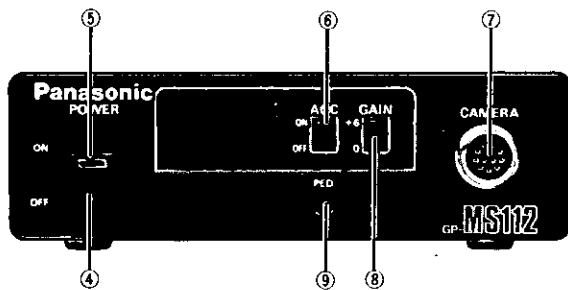

1. **Manual Iris Control Ring**
This ring is used to adjust the lens iris manually.
2. **Focus Ring**
This ring is used to adjust the focus of the picture. To adjust the focus, loosen the Focus Lock Ring (3) by rotating it clockwise (viewed from the front of the camera) and turn the Focus Ring until picture becomes the best resolution. Secure the Focus Lock Ring (3) by rotating the Focus Lock Ring (3) counterclockwise.
3. **Focus Lock Ring**
This ring is used to secure the Focus Ring (2).
4. **Power ON/OFF Switch (ON/OFF)**
5. **Power Indicator (POWER)**
6. **AGC Selection Switch (AGC, ON/OFF)**
This switch is used to select the gain of video amplifier as follows.
OFF: The automatic gain control (AGC) is disabled and the gain of video amplifier is set to the fixed value.
ON: The AGC function is enabled and the maximum gain increase of video amplifier is approximately 12 dB.
7. **Camera Cable Connector (CAMERA)**
This 12-pin connector is used for connection of the camera cable. (See page 6.)
Caution:
Connecting or disconnecting the camera cable must be done after turning OFF the Power ON/OFF switch.
8. **Gain Selection Switch (GAIN, +6/0)**
By setting this switch to +6 dB position, the gain of the video amplifier is set to 6 dB higher than that of 0 dB position independently from the AGC selection switch(7).
9. **Pedestal Control (PED)**
The pedestal level Y signal of the composite video signal can be adjusted by this control.
10. **DC 12V Input Terminals (DC 12V IN)**
This terminal accept an external DC source supplying nominal power of 12V, 0.5A - 0.7A.
CAUTION:
CONNECT THIS TO A DC 12V CLASS 2 POWER SUPPLY ONLY.

Caution:
To Prevent fire or shock hazard, the UL listed wire VW-1, style 1007 should be used for the cable for DC 12V Input Terminal.

11. **Video Output Connector (VIDEO OUT) (BNC)**
A 1.0Vp-p/75 ohms composite video signal is provided at the connector.
12. **Horizontal Drive/Gen-Lock Input Connector (HD/GEN-LOCK) (Gen-Lock Mode)**
The video signal of the camera is automatically synchronized to the gen-lock signal (composite or video signal) which is supplied to this connector. The gen-lock signal is used for system reference, such as when using the Special Effects Generator.
Caution:
If the gen-lock signal is jittery (such as when obtained from VTR playback), the camera may not be able to synchronize properly.
(External HD and VD Mode)
The horizontal and vertical phase of the video signal is synchronized to the external HD fed to this connector and external VD fed to the Vertical Drive (VD) Input Connector (13).
CAUTION:
Camera may function improperly when only HD or only VD is fed to.
13. **Vertical Drive Input Connector (VD)**
Feed the Vertical Drive pulse to this connector for the External HD and VD.
CAUTION:
Camera may function improperly when only HD or only VD is fed to.
14. **Gen lock Termination Switches (G/L 75 Ω, ON/OFF)**
When looping through the gen-lock video input signal, set this switch to OFF position and other cases, set this to ON position.
15. **Horizontal Phase Control (H. PHASE)**
The horizontal phase of the camera signal can be adjusted to match the horizontal phase of the signal fed to the Horizontal Drive/Gen-Lock Input connector (12).
This control should be adjusted when the camera is used in a system configuration with the Special Effects Generator. (See "GEN-LOCK ADJUSTMENTS" on page 7.)

PREPARATIONS

Caution:

Keep the Power ON/OFF switch of the camera in the OFF position throughout the installation.

• **GP-MS112 with GP-LM3T, GP-LM7R5TA, GP-LM15T or GP-LP12T**

1. Remove the front cap of the camera head and confirm that the surface of the optical filter of the camera head is clean.



If the surface of the optical filter is dirty or dusts are on it, clean it up with a blower brush which is for film camera lenses (may be available at your local camera store) or supplied lens cleaning tissue paper.

2. Rotate the focus lock ring fully clockwise (1). Mount the Pinhole Lens or Wide-angle Lens to the camera by rotating it clockwise slowly (2).

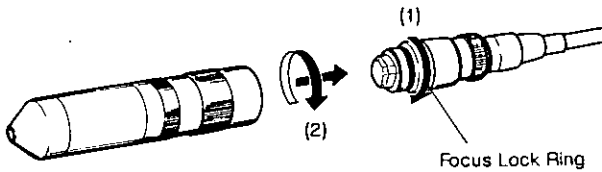

GP-LP12T

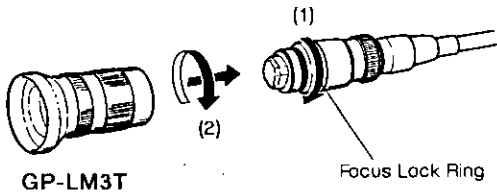

GP-LM3T

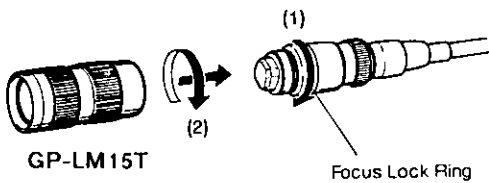

GP-LM15T

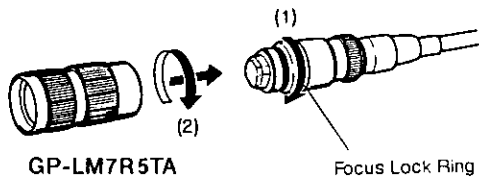

GP-LM7R5TA

• **GP-MS112 with GP-AD22T and Optional C-mount Lens**

1. Remove the front cap of the camera head and confirm that the surface of the optical filter of the camera head is clean.

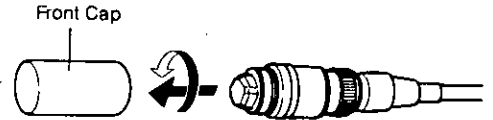

If the surface of the optical filter is dirty or dusts are on it, clean it up with a blower brush which is for film camera lenses (may be available at your local camera store) or supplied lens cleaning tissue paper.

2. Attach the optional C-mount lens to the C-mount adaptor GP-AD22 by rotating it clockwise.

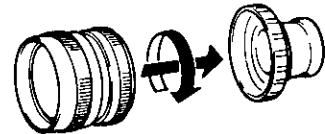

3. Rotate the focus lock ring fully clockwise (1). Mount the lens and C-mount adaptor by rotating them clockwise slowly (2).

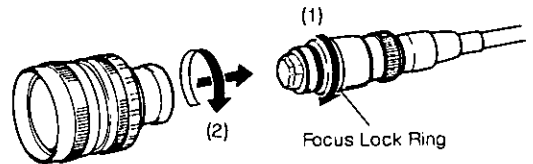

Caution:

If the optional C-mount lens size exceeds 2" (50.8 mm) in diameter, 2-3/4" (70 mm) in length and 0.66 lbs (300g) in weight, both the camera and lens should be secured.

CONNECTIONS

Caution:

1. Keep the Power ON/OFF Switch in the OFF position until all connections have been properly made.
2. Connect the camera head and camera control unit which are packed in the same box (a pair) otherwise it would cause a improper operation.

• Internal Sync Operation

1. Connect the camera cable with 12-pin connector of the camera head to the Camera Cable Connector (7) on the front panel of the camera control unit.
2. Connect the coaxial cable with BNC connectors between the Video Output connector (11) of the camera control unit and the video monitor or VTR.

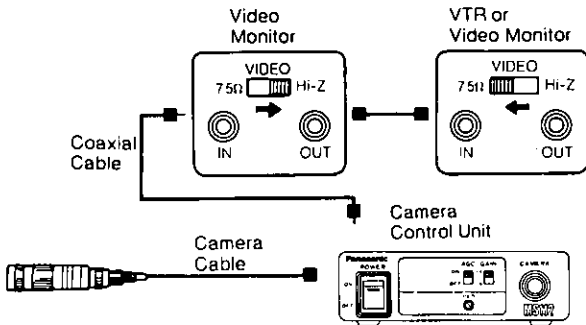

3. Connect the power cable between the DC 12V IN terminals and the power supply of 12V DC (sold separately).

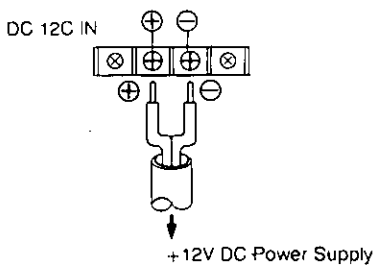

• Gen-lock Operation

1. Connect the camera cable with 12-pin connector of the camera head to the Camera Cable Connector (7) on the front panel of the camera control unit.
2. Connect the coaxial cables with BNC connectors between the Video Output connector (11) of camera control unit and the Video Input of Special Effects Generator and between the VS Output connector of SEG and the Gen-Lock Input connector of camera control unit.
3. Connect the power cable between the DC 12V IN terminals and the Power Supply of 12V DC (sold separately).

CAUTION: CONNECT THIS TO A DC 12V CLASS 2 POWER SUPPLY ONLY.

Caution:

To Prevent fire or shock hazard, the UL listed wire VW-1, style 1007 should be used for the cable for DC 12V Input Terminal.

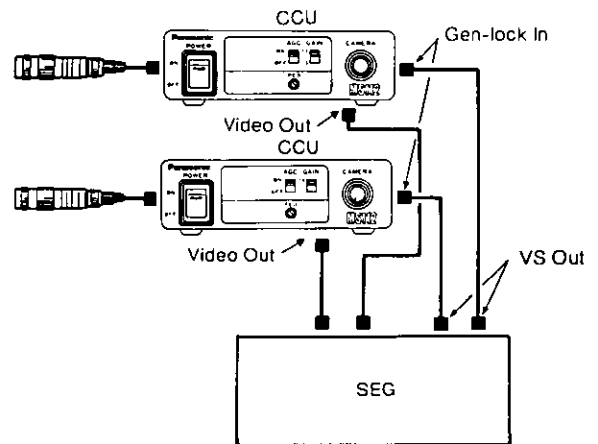

CAUTION: CONNECT THIS TO A DC 12V CLASS 2 POWER SUPPLY ONLY.

Caution:

To Prevent fire or shock hazard, the UL listed wire VW-1, style 1007 should be used for the cable for DC 12V Input Terminal.

GEN-LOCK ADJUSTMENT

- **Horizontal Phase Adjustment**

Adjust the Horizontal Phase Control (15) on the Camera Control Unit so that the phase of the horizontal blanking of the camera signal matches that of the Special Effects Generator.

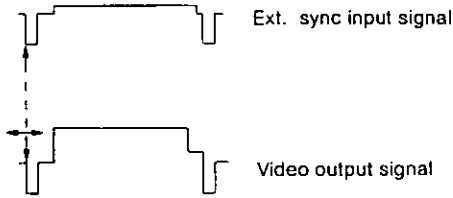

INSTALLATIONS

- **Camera Head**

Camera head can be installed to the ceiling, wall etc. using the threaded 1/4"-20 UNC screw hole of the Tripod Attachment (Standard Accessory).

1. Loosen the screw of camera holding band until it is stopped and insert to the camera head.

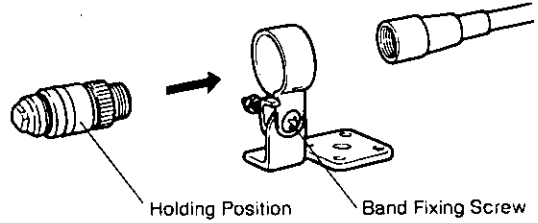

2. Loosen the screw of camera holding band.
Note: Do not remove the screw from the band.
3. Adjust the tilt and rotation of camera head and secure the screw of camera holding band.

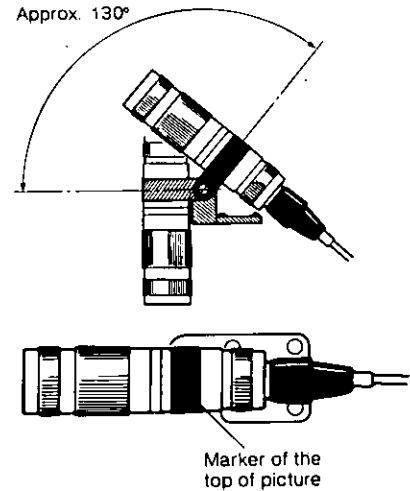

4. Mount the tripod attachment onto the tripod or other mounting bracket (sold separately).

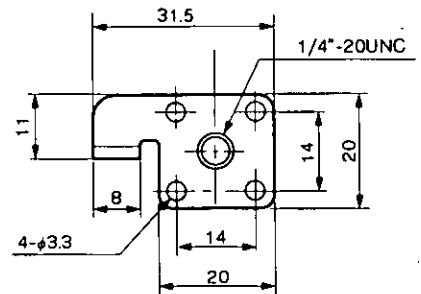

Caution:

If the optional C-mount lens size exceeds 2" (50.8 mm) in diameter, 2-3/4" (70 mm) in length and 0.66 lbs (300g) in weight, both the camera and lens should be secured.

SPECIFICATIONS

Pick-up Device :	1/2-inch Interline transfer CCD image sensor with 682(H) x 492(V) pixels
Horizontal Resolution :	500 lines
Minimum Scene Illumination :	0.07 footcandles (0.7 lux) (F1.4 with AGC ON and +6 dB ON, more than 10 IRE of Y signal with set up)
Signal to Noise Ratio :	46 dB
Video Output :	1.0Vp-p/75 ohms, composite video, BNC connector x 1
Scanning System :	2:1 Interlace
Synchronization :	Internal/External (Composite/VS or HD & VD)
Gain Control :	AGC ON (+9dB)/OFF Switch, Gain (0/+6 dB)/Switch
Controls :	PED LEVEL, Horizontal phase (H PHASE)
Power Source :	12V DC, 350 mA
Maximum Camera Cable Length :	99 feet (30 meters)
Ambient Temperature :	14°F - 104°F (-10°C - +40°C)
Dimensions	
Camera Head :	2/3" (Diameter) x 1-1/2" (D), (17(Diameter) x 36.8 (D) mm)
Camera Control Unit :	4-11/16" (W) x 1-7/16" (H) x 6-1/8" (D) (120(W) x 36(H) x 157 (D) mm)
Weight	
Camera Head :	0.04 lbs (16g)
Camera Control Unit :	1.6 lbs (700g)

Weight and dimensions indicated are approximate.
Specifications are subject to change without notice.

STANDARD CONFIGURATION

- o Camera Head
- o Tripod Attachment
- o Camera Control Unit

OPTIONAL ACCESSORIES

- o Camera Cable
 - GP-CA44: 6.6 feet (2 meters)
 - GP-CA45: 16.5 feet (5 meters)
 - GP-CA46: 33.0 feet (10 meters)
 - GP-CA49: 99.0 feet (30 meters)
- o C-mount Adaptor GP-AD22T
- o Wide-angle Lens GP-LM3T or GP-LM7R5TA
- o Pinhole Lens GP-LP12T
- o Telephoto Lens GP-LM15T

Panasonic

Communications & Systems Company

Panasonic Communications & Systems Company
Division of Matsushita Electric Corporation of America

INDUSTRIAL CAMERA DIVISION

HEAD OFFICE

50 Meadowland Parkway, Secaucus, New Jersey 07094 (201) 392-6674

WEST OFFICE

6550 Katella Ave., Cypress, CA 90630 (714) 373-7270

MATSUSHITA ELECTRIC OF CANADA LIMITED

5770 Ambler Drive, Mississauga, Ontario, Canada L4W 2T3 (416) 624-5010

PANASONIC SALES COMPANY

DIVISION OF MATSUSHITA ELECTRIC OF PUERTO RICO, INC.

San Gabriel Industrial Park, 65th Infantry, Ave. KM. 9.5 Carolina, Puerto Rico 00630 (809) 750-4300