

AJHS08DCC

GE® 230/208 Volt Built-In Heat Pump

Wall Case Dimensions and Installation Information (in inches)

Note: When installing slide-out chassis units in through-the-wall applications, keep louvers free. Do not restrict air flow areas.

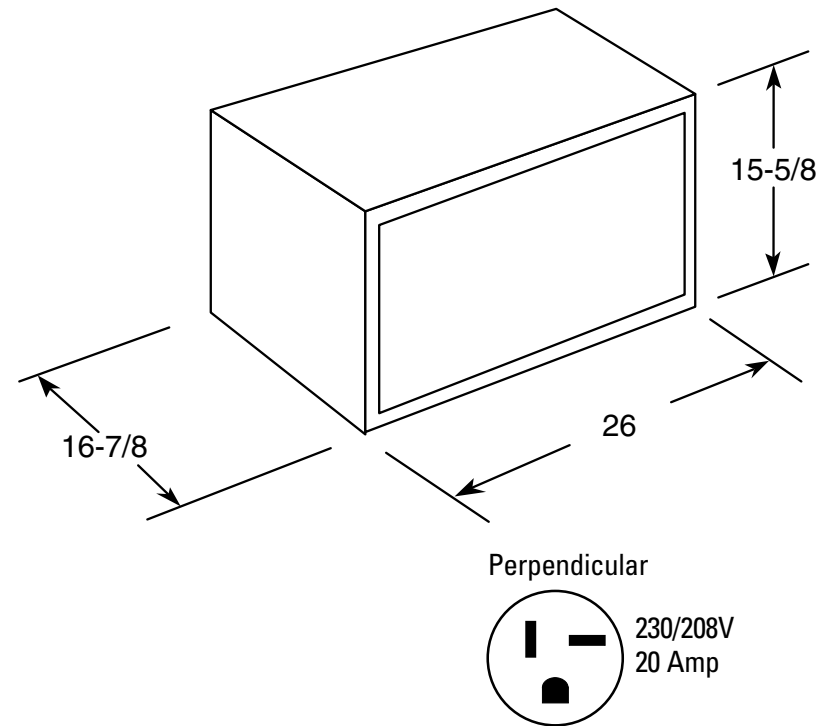

For answers to your Monogram®, GE Profile™ or GE® appliance questions, visit our website at ge.com or call GE Answer Center® service, 800.626.2000.



Total volume and shelf area are calculated by the Association of Home Appliance Manufacturers' standards.



Listed by Underwriters Laboratories

AJHS08DCC

GE® 230/208 Volt Built-In Heat Pump

Wall Case Dimensions and Installation Information (in inches)

Installation Information: A finished opening of 26-1/8" x 15-3/4" clear of intrusions is required. Keep clearance of 4" from side walls. Brick veneer or frame walls should have wood studding surrounding case to provide firm anchoring with screws. Case can be fastened directly to brick or block walls with screws sunk in lead expansion shields.

Note: Units should be caulked on all four sides of case to the building exterior to assure building integrity.

Two Wall Cases for Tenant Option Installation

When the air conditioner is offered as a tenant option, these wall cases provide protection against outside elements.

RAB47 – includes wall case, exterior grille and steel closure panels.

RAB48 – includes wall case, exterior grille, steel closure panel and two layers of insulation.

Standard Wall Case RAB46

Solid-sided wall case fabricated of galvanized steel with baked enamel finish. Welded areas are coated with a sealing compound to help resist rust and corrosion. Polymer gasket surrounds opening to assure tight weather seal. Aluminum grille (RAG13) is included. Panels on interior and between case and grille provide weather protection prior to installation of chassis. Provide firm anchoring with screws. Case can be fastened directly to brick or block walls with screws sunk in lead expansion shields.

For answers to your Monogram®, GE Profile™ or GE® appliance questions, visit our website at ge.com or call GE Answer Center® service, 800.626.2000.



imagination at work

Make frame if desired or caulk between case and siding

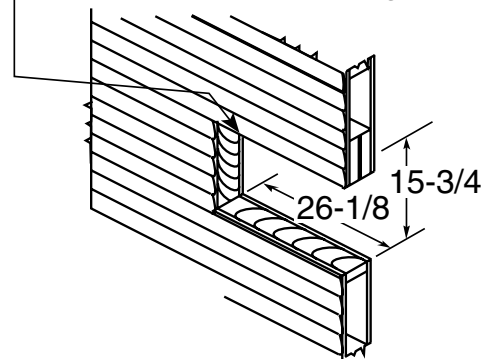

Frame Construction

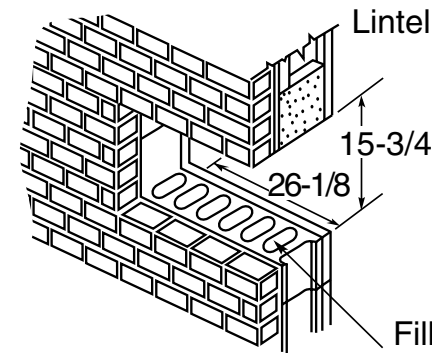

Brick Block and Brick Frame Construction

Fill open cells with mortar or insulation

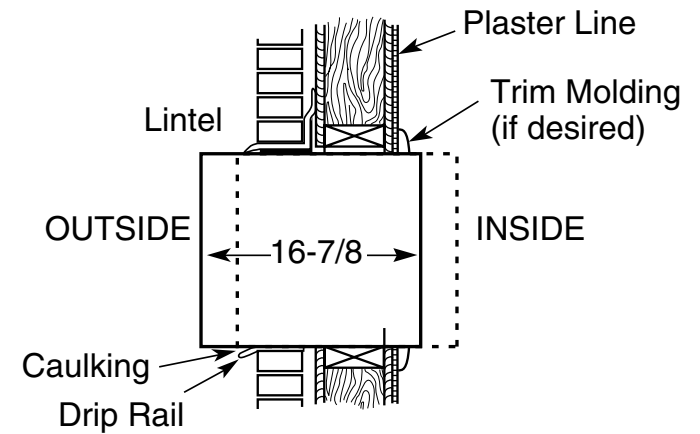

Flexible Mounting Position



Total volume and shelf area are calculated by the Association of Home Appliance Manufacturers' standards.



Listed by Underwriters Laboratories

AJHS08DCC

GE® 230/208 Volt Built-In Heat Pump

Features and Benefits

- 8,550/8,300 BTU
- 7,700/7,500 BTU pump
- 11,600/9,500 BTU strip
- 9.5/9.5 EER
- 230/208 Volts
- Mechanical controls
- Variable position thermostat
- Four-way air direction
- Up-front, washable air filter
- 2 cool/2 heat/2 fan only speeds
- Model AJHS08DCC – Soft Gray

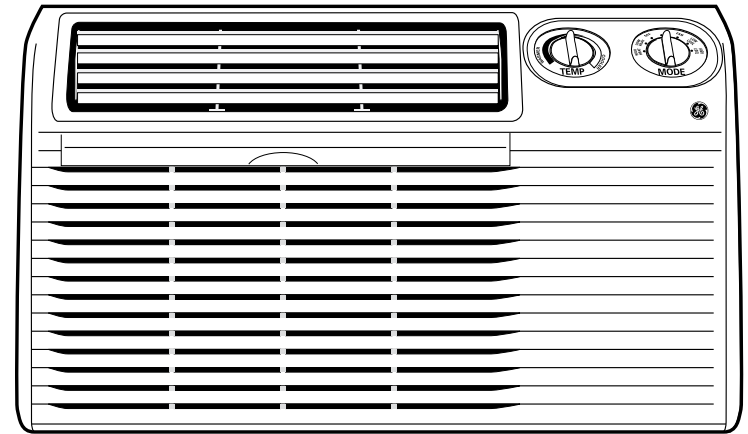

For answers to your Monogram®, GE Profile™ or GE® appliance questions, visit our website at ge.com or call GE Answer Center® service, 800.626.2000.



Total volume and shelf area are calculated by the Association of Home Appliance Manufacturers' standards.



Listed by Underwriters Laboratories