

CD Soundmachine

AZ1301
AZ1325

PHILIPS CONSUMER ELECTRONICS NORTH AMERICA

Knoxville, Tennessee 37914-1810, U.S.A.

User Manual
Manuel d'utilisation
Manual del usuario

Meet Philips at the Internet

<http://www.philips.com>



Need help? Call us!

Philips representatives are ready to help you with any questions about your new product.

CALL US BEFORE YOU CONSIDER RETURNING THE PRODUCT!

1-800-531-0039

or visit us on the web at www.philips.com

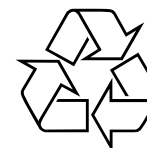

AZ1301
AZ1325



PHILIPS



Return your Warranty Registration card today to ensure you receive all the benefits you're entitled to.

- Once your Philips purchase is registered, you're eligible to receive all the privileges of owning a Philips product.
- So complete and return the Warranty Registration Card enclosed with your purchase at once, and take advantage of these important benefits.

Warranty Verification

Registering your product within 10 days confirms your right to maximum protection under the terms and conditions of your Philips warranty.

Owner Confirmation

Your completed Warranty Registration Card serves as verification of ownership in the event of product theft or loss.

Model Registration

Returning your Warranty Registration Card right away guarantees you'll receive all the information and special offers which you qualify for as the owner of your model.

Know these *safety* symbols



This "bolt of lightning" indicates uninsulated material within your unit may cause an electrical shock. For the safety of everyone in your household, please do not remove product covering.

The "exclamation point" calls attention to features for which you should read the enclosed literature closely to prevent operating and maintenance problems.

For Customer Use

Enter below the Serial No. which is located on the rear of the cabinet. Retain this information for future reference.

Model No. _____

Serial No. _____

WARNING: TO PREVENT FIRE OR SHOCK HAZARD, DO NOT EXPOSE THIS EQUIPMENT TO RAIN OR MOISTURE.

CAUTION: To prevent electric shock, match wide blade of plug to wide slot, and fully insert.

IMPORTANT SAFETY INSTRUCTIONS

1. Read these instructions.
2. Keep these instructions.
3. Heed all warnings.
4. Follow all instructions.
5. Do not use this apparatus near water.
6. Clean only with dry cloth.
7. Do not block any ventilation openings. Install in accordance with the manufacturer's instructions.
8. Do not install near any heat sources such as radiators, heat registers, stoves, or other apparatus (including amplifiers) that produce heat.
9. Do not defeat the safety purpose of the polarized or grounding-type plug. A polarized plug has two blades with one wider than the other. A grounding type plug has two blades and a third grounding prong. The wide blade or the third prong are provided for your safety. If the provided plug does not fit into your outlet, consult an electrician for replacement of the obsolete outlet.
10. Protect the power cord from being walked on or pinched, particularly at plugs, convenience receptacles, and the point where they exit from the apparatus.
11. Only use attachments/accessories specified by the manufacturer.
12.  Use only with the cart, stand, tripod, bracket, or table specified by the manufacturer or sold with the apparatus. When a cart is used, use caution when moving the cart/apparatus combination to avoid injury from tip-over.
13. Unplug this apparatus during lightning storms or when unused for long periods of time.
14. Refer all servicing to qualified service personnel. Servicing is required when the apparatus has been damaged in any way, such as power-supply cord or plug is damaged, liquid has been spilled or objects have fallen into the apparatus, the apparatus has been exposed to rain or moisture, does not operate normally, or has been dropped.
15. Battery usage CAUTION – To prevent battery leakage which may result in bodily injury, property damage, or damage to the unit:
 - Install all batteries correctly, + and - as marked on the unit.
 - Do not mix batteries (old and new or carbon and alkaline, etc.).
 - Remove batteries when the unit is not used for a long time.
16. Apparatus shall not be exposed to dripping or splashing.
17. Do not place any sources of danger on the apparatus. (e.g. liquid filled objects, lighted candles).
18. This product may contain lead and mercury. Disposal of these material may be regulated due to environment considerations. For disposal or recycling information, please contact your local authorities or the Electronic Industries Alliance : www.eiae.org.

EL 6475-E004: 03/12

Class II equipment symbol



This symbol indicates that the unit has a double insulation system.

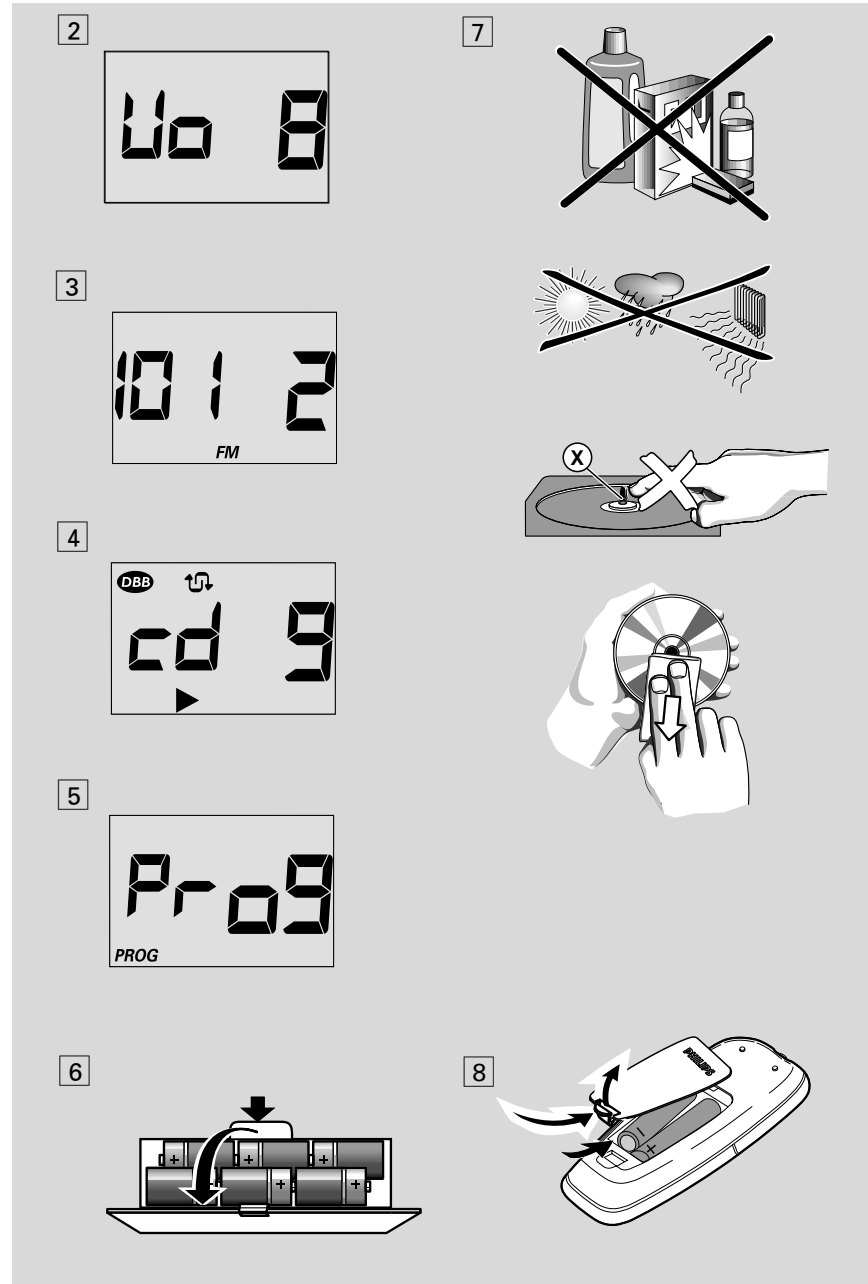
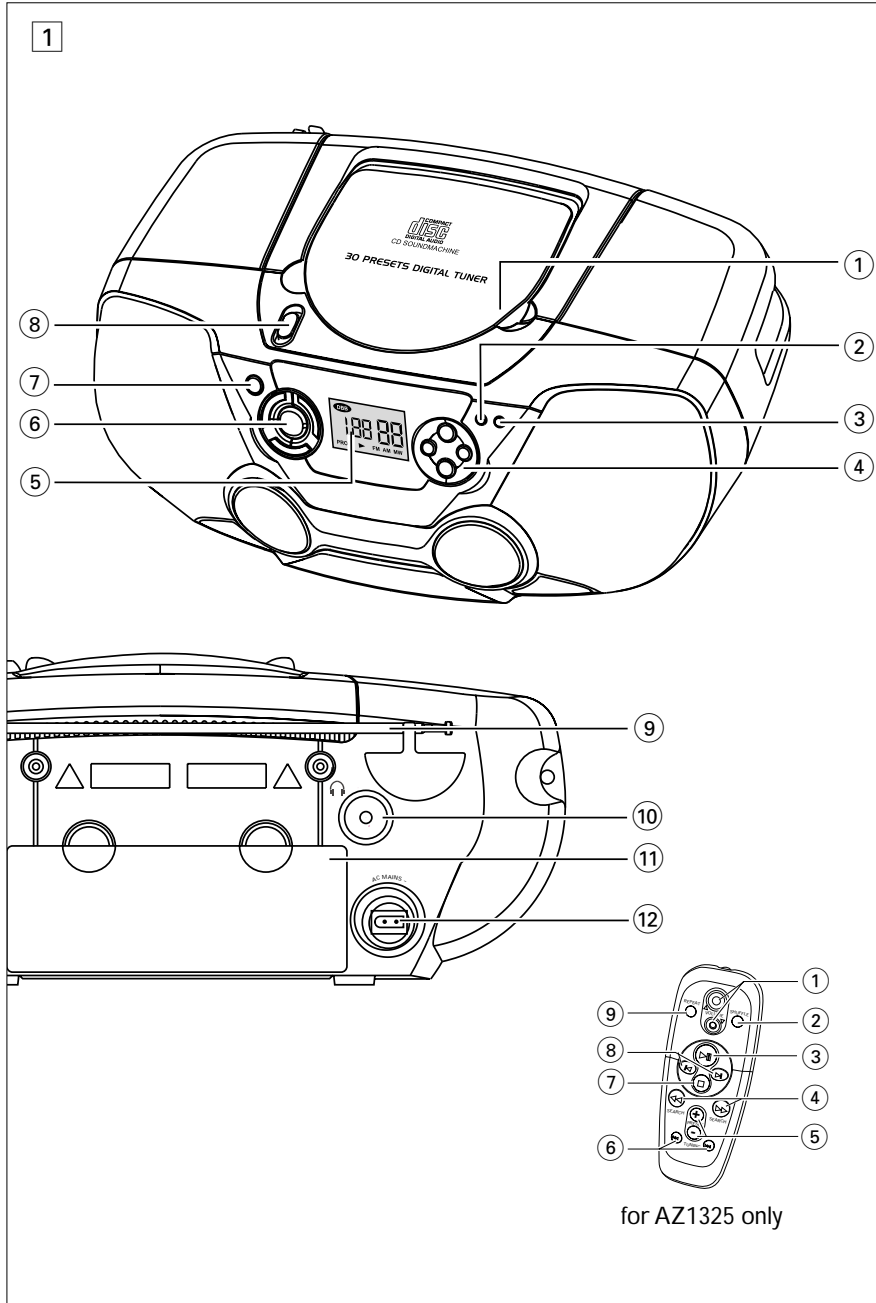

English

ACCESSORIES

- 1 x AC power cord
- 1 x Remote Control (For AZ1325 only)

TOP AND FRONT PANEL (See [1])

- ① **OPEN•CLOSE** – opens/closes the CD door
- ② **PROG**
CD: - programs tracks and reviews the program;
Tuner: - programs preset radio stations.
- ③ **MODE** - selects different play modes: e.g. **REPEAT** or **SHUFFLE** (random) order.
- ④ **VOLUME ▲, ▼** - to adjust volume level.
PRESET +, - (up, down) - selects a preset radio station.
- ⑤ **Display** - shows the status of the set.
- ⑥ **▶II** - starts or pauses CD playback.
■ - to stop playback or erase a CD program.
SEARCH ◀◀, ▶▶
CD: - searches backward and forward within a track;
- skips to the beginning of a current track/
previous/ later track.
RADIO: - (down, up) tunes to radio stations.
- ⑦ **DBB (Dynamic Bass Boost)** - activates a more vivid bass response.
- ⑧ **POWER slider** - selects **CD/ AM / FM / OFF** function and also the power off switch (**OFF**).

BACK PANEL (See [1])

- ⑨ **Telescopic antenna** - improves FM reception.
- ⑩ **🔊** - 3.5 mm stereo headphone jack.
Note: The speakers will be muted when headphones are connected to the set.
- ⑪ **Battery compartment** - for 6 batteries, type **R-14, UM2** or **C-cells**.
- ⑫ **AC MAINS** - inlet for power cord.

CONTROL

REMOTE CONTROL (For AZ1325 only)

- ① **VOLUME ▲, ▼** - adjusts volume level.
- ② **SHUFFLE** - plays all CD tracks in random order.
- ③ **▶II** - starts or pauses CD playback.
- ④ **SEARCH ◀◀, ▶▶** - searches backwards/ forwards within a track.
- ⑤ **PRESET +, -** (up, down) - selects a preset radio station.
- ⑥ **TUNING ◀◀, ▶▶** (down, up) - tunes to tuner stations.
- ⑦ **■** - to stop playback;
- erases a CD program.
- ⑧ **◀, ▶** - skips to the beginning of a current track previous/ subsequent track.
- ⑨ **REPEAT** - repeats a track /program/ entire CD.

CAUTION

Use of controls or adjustments or performance of procedures other than herein may result in hazardous radiation exposure or other unsafe operation.

POWER SUPPLY

Whenever convenient, use the AC power supply to conserve battery life. Make sure you remove the power plug from the set and wall outlet before inserting batteries.

Batteries (not included)

- Insert 6 batteries, type **R-14, UM-2** or **C-cells**, (preferably alkaline) with the correct polarity. (See [6])
- **Remote control** (For AZ1325 only)
Insert 2 batteries, type **AAA, R03** or **UM4** (preferably alkaline). (See [8])

POWER SUPPLY

IMPORTANT!

- Incorrect use of batteries can cause electrolyte leakage and will corrode the compartment or cause the batteries to burst.
- Do not mix battery types: e.g. alkaline with carbon zinc. Only use batteries of the same type for the set.
- When inserting new batteries, do not try to mix old batteries with the new ones.
- **Batteries contain chemical substances, so they should be disposed of properly.**

Using AC Power

1. Check if the AC power supply, as shown on the **type plate located on the bottom of the set**, corresponds to your local power supply. If it does not, consult your dealer or service center.
2. Connect the power cord to the outlet.
3. To disconnect the power supply, unplug the set from the outlet.

The type plate is located on the bottom of the set.

POWER SUPPLY

BASIC FUNCTIONS

Switching on and off and selecting function

1. To switch on, adjust the **POWER slider** to select: **CD, AM, FM** function, and operate the respective function controls.
2. To switch off, adjust the **POWER slider** to select **OFF**.

Note : The DBB setting, tuner presets and the volume level (maximum to 20) will be retained in the set's memory.





Adjusting volume and sound (See [2])

1. Adjust the volume with the **VOLUME** controls.
→ Display shows the volume level in number from 0-32.
2. Press **DBB** once or more to select dynamic bass boost on or off.
→ Display: shows **DBB** when activated.

DIGITAL TUNER

DIGITAL TUNER

Tuning to radio stations

1. Adjust the **POWER slider** to **AM** or **FM**.
 - The radio station frequency, waveband are shown (See [3])
 2. Press and hold **SEARCH**  or  until the frequency in the display starts running.
 - The radio automatically tunes to a station of sufficient reception. Display shows 57.2 MHz during automatic tuning.
 3. Repeat step 2 if necessary until you find the desired station.
- To tune to a weak station, press  or  briefly and repeatedly until you have found optimal reception.

To improve radio reception:

- For **FM**, extend, incline and turn the telescopic antenna. Reduce its length if the signal is too strong.
- For **AM**, the set uses a built-in antenna. Direct this antenna by turning the whole set.

Programming radio stations

You can store up to a total of 30 radio stations (20 FM and 10 AM) in the memory, manually or automatically (Autostore).

DIGITAL TUNER

Manual programming

1. Tune to your desired station (see **Tuning to radio stations**).
2. Press **PROG** to activate programming.
 - **PROG** flashes.
3. Press **PRESET + / -** once or more to select a preset number.
 - **Remote control (AZ1325 models only)**: Press **PRESET + / -** once or more to select a preset station.
4. Press **PROG** to confirm.
5. Repeat steps 1-4 to store other stations.

Note : You can erase a preset station by storing another frequency in its place.

Autostore

Autostore automatically starts programming radio stations from preset 1. Available stations are programmed in order if the station with sufficient reception strength. Any previous presets e.g. manually programmed will be erased.

- Press **PROG** for 2 seconds or more to activate autostore programming.
 - The display shows RUZ , **PROG** blinks, followed by the radio station details when stored.

After all stations are stored, the first preset station will then automatically play.





To listen to a preset station

- Press the **PRESET + , -** buttons once or more until the desired preset station is displayed.
- Remote control : optionally, press **PRESET + , -** to select your preset station.

CD PLAYER

Playing a CD



This CD-player can play all kinds of **Audio Discs** such as CD-Recordables and CD-Rewritables. Do not try to play a CD-ROM, CDI, VCD, DVD or computer CD.

1. Adjust the **POWER slider** to **CD**.
2. Open the CD Door.
 - CD is displayed.
3. Insert a CD with the printed side facing up and close the door.
 - CD if no CD inserted/ CD dirty, incorrectly inserted or damaged.
 - FCD if you have inserted a non-finalized CD-R(W).
4. Press  to start playback.
5. To pause playback press . Press  again to resume play.
 - Display: flashes during pause.
6. To stop CD playback, press the  button.

Note : CD play will also stop when:





- the CD door is opened
- the CD has reached the end
- you select **AM / FM** function.

Selecting a different track

- Press **SEARCH**  or  once or repeatedly to select your track.
- In the pause / stop position, press  to start playback.

CD PLAYER





Finding a passage within a track



1. Press and hold **SEARCH**  or .
 - The CD is played at high speed and low volume.
2. When you recognize the passage you want, release  or  to resume normal playback.

Note : During a CD program or if **SHUFFLE/ REPEAT** active, searching is only possible within a track.

Different play modes: SHUFFLE and REPEAT

You can select and change the various play modes before or during playback, and combine the modes with PROG. (See [4])

-  (**SHUFFLE**) - tracks of the entire CD/ program are played in random order
-  (**SHUFFLE REPEAT ALL**) - to repeat the entire CD/ program continuously in random order
-  (**REPEAT ALL**) - repeats the entire CD/ program
-  (**REPEAT**) - plays the current track continuously

1. To select play mode, press **MODE** once or more.
2. Press  to start playback if in the stop position.
3. To select normal playback, press **MODE** repeatedly until the various modes are no longer displayed.
 - You can also press the  button to cancel your play mode.

CD PLAYER

Programming track numbers

In the stop position, select and store your CD tracks in the desired sequence. Up to 20 tracks can be stored in the memory.

1. Press **SEARCH** ◀◀ or ▶▶ on the set to select your desired track number.
2. Press **PROG**.
 - Display: **PROG**, *P R 0 5* briefly and your selected track number. (See [5])
 - If you attempt to program without first selecting a track number, *n 0 5 E* is shown.
3. Repeat steps **1-2** to select and store all desired tracks.
 - Display: *F U L L* if you try to program more than 20 tracks.

Reviewing the program

In the stop position, press and hold **PROG** until the display shows all your stored track numbers in sequence.

Erasing a program

You can erase the program by either:

- pressing **■** twice
 - *E L R* is displayed briefly and **PROG** disappears.
- You select **AM / FM** function.
- Open the CD door.

SAFETY AND MAINTENANCE

SAFETY & MAINTENANCE INFORMATION (See [7])

- Don't expose the set, batteries, CDs to humidity, rain, sand or excessive heat.
- Clean the set with a dry cloth. Don't use any cleaning agents containing alcohol, ammonia, benzene or abrasives as these may harm the set.
- Place the set on a hard and flat surface so that the system does not tilt. Make sure there is good ventilation to prevent the set overheating.
- Apparatus shall not be exposed to dripping or splashing.
- Do not place any sources of danger on the apparatus (e.g. liquid filled objects, lighted candles).
- The mechanical parts of the set contain self-lubricating bearings and must not be oiled or lubricated.

CD player and CD handling

- If the CD player cannot read CDs correctly, use a cleaning CD to clean the lens before taking the set to repair.
- The lens of the CD player should never be touched!
- Sudden changes in the surrounding temperature can cause condensation on the lens of your CD player. Playing a CD is then not possible. Do not attempt to clean the lens but leave the set in a warm environment until the moisture evaporates.
- Always close the CD door to avoid dust on the lens.
- To clean the CD, wipe in a straight line from the center towards the edge using a soft, lint-free cloth. Do not use cleaning agents as they may damage the disc.
- *Never* write on a CD or attach any stickers to it.

TROUBLESHOOTING

If a fault occurs, first check the points listed below before taking the set for repair. If you are unable to remedy a problem by following these hints, consult your dealer or service center.

WARNING: *Do not open the set as there is a risk of electric shock. Under no circumstances should you try to repair the set yourself, as this will invalidate the warranty.*

No sound /power

- *Volume not adjusted*
- Adjust the **VOLUME**
- *Power cord not securely connected*
- Connect the AC power cord properly
- *Batteries drained/ incorrectly inserted*
- Insert (fresh) batteries correctly
- *Headphones connected to the set*
- Disconnect headphones

Severe radio hum or noise

- *Electrical interference: set too close to TV, VCR or computer*
- Move the set to increase the distance

Poor radio reception

- *Weak radio signal*
- **FM:** Adjust the FM telescopic antenna

n 0 c d indication

- *CD badly scratched or dirty*
- Replace/ clean CD, see Maintenance
- *Laser lens steamed up*
- Wait until lens has cleared

n F c d indication

- *CD-R(W) is blank/ not finalized*
- Use a finalized CD-R(W)

d R L R indication

- *CD contains non-audio files*
- Press **SEARCH** ◀◀ or ▶▶ once or more to skip to a CD audio track, instead of the data file

The CD skips tracks

- *CD damaged or dirty*
- Replace or clean CD
- *SHUFFLE or PROG is active*
- Switch off **SHUFFLE / PROG**

Remote control does not function properly (For AZ1325 only)

- *Batteries exhausted/ incorrectly inserted*
- Insert (fresh) batteries correctly
- *Distance/ angle between the set too large*
- Reduce the distance/ angle

Environmental information

We have done our best to reduce the packaging and make it easy to separate into 3 materials: cardboard, expandable polystyrene, polyethylene.

Your set consists of materials which can be recycled if disassembled by a specialized company. Please observe the local regulations regarding the disposal of packaging, dead batteries and old equipment.

LIMITED WARRANTY

PORTABLE AUDIO

One Year Free Exchange

This product must be carried in for an exchange.

WHO IS COVERED?

You must have proof of purchase to exchange the product. A sales receipt or other document showing that you purchased the product is considered proof of purchase. Attach it to this owner's manual and keep both nearby.

WHAT IS COVERED?

Warranty coverage begins the day you buy your product. For one year thereafter, a defective or inoperative product will be replaced with a new, renewed or comparable product at no charge to you. A replacement product is covered only for the original warranty period. When the warranty on the original product expires, the warranty on the replacement product also expires.

WHAT IS EXCLUDED?

Your warranty does not cover:

- labor charges for installation or setup of the product, adjustment of customer controls on the product, and installation or repair of antenna systems outside of the product.
- product repair and/or part replacement because of misuse, accident, unauthorized repair or other cause not within the control of Philips.
- reception problems caused by signal conditions or cable or antenna systems outside the unit.
- a product that requires modification or adaptation to enable it to operate in any country other than the country for which it was designed, manufactured, approved and/or authorized, or repair of products damaged by these modifications.
- incidental or consequential damages resulting from the product. (Some states do not allow the exclusion of incidental or consequential damages, so the above exclusion may not apply to you. This includes, but is not limited to, prerecorded material, whether copyrighted or not copyrighted.)
- a product used for commercial or institutional purposes.

WHERE IS EXCHANGE AVAILABLE?

You may exchange the product in all countries where the product is officially distributed by Philips. In countries where Philips does not distribute the product, the local Philips service organization will attempt to provide a replacement product (although there may be a delay if the appropriate product is not readily available).

BEFORE REQUESTING EXCHANGE...

Please check your owner's manual for assistance. If you have additional questions, call us at 1-800-531-0039.

EXCHANGING A PRODUCT IN U.S.A., PUERTO RICO, OR U.S. VIRGIN ISLANDS...

Contact 1-800-531-0039 to arrange an exchange. Or, ship the product, insured and freight prepaid, and with proof of purchase enclosed, to the address listed below.

Philips Exchange Program
Suite A
406 North Irish Street
Greenville TN 37745

(In U.S.A., Puerto Rico, and U.S. Virgin Islands, all implied warranties, including implied warranties of merchantability and fitness for a particular purpose, are limited in duration to the duration of this express warranty. But, because some states do not allow limitations on how long an implied warranty may last, this limitation may not apply to you.)

EXCHANGING A PRODUCT IN CANADA...

Please contact Philips at:

1-800-661-6162 (French Speaking)
1-800-531-0039 (English or Spanish Speaking)

(In Canada, this warranty is given in lieu of all other warranties. No other warranties are expressed or implied, including any implied warranties of merchantability or fitness for a particular purpose. Philips is not liable under any circumstances for any direct, indirect, special, incidental or consequential damages, howsoever incurred, even if notified of the possibility of such damages.)

REMEMBER...

Please record below the model and serial numbers found on the product. Also, please fill out and mail your warranty registration card promptly. It will be easier for us to notify you if necessary.

MODEL # _____

SERIAL # _____

This warranty gives you specific legal rights. You may have other rights which vary from state/province to state/province.

Philips, P.O. Box 520890, Miami, FL 33152, USA, (402) 536-4171

EL6095T004 / 8-02