

FURUNO

OPERATOR'S MANUAL

ECHO SOUNDER

MODEL FE-88 I II



FURUNO ELECTRIC CO., LTD.
NISHINOMIYA, JAPAN

© FURUNO ELECTRIC CO., LTD.

9-52, Ashihara-cho,
Nishinomiya, Japan 662

Telephone: 0798-65-2111
Telefax: 0798-65-4200 (G111)

All rights reserved. Printed in Japan

(ETMI)

PUB. No. OME-22721
FE-881 M2

•Your Local Agent/Dealer

Initial : FEB 1983
F : MAY 31, 1996





SAFETY INSTRUCTIONS

"**DANGER**", "**WARNING**" and "**CAUTION**" notices appear throughout this manual. It is the responsibility of the operator of the equipment to read, understand and follow these notices. If you have any questions regarding these safety instructions, please contact a FURUNO agent or dealer.



DANGER

This notice indicates a potentially hazardous situation which, if not avoided, will result in death or serious injury.



WARNING

This notice indicates a potentially hazardous situation which, if not avoided, could result in death or serious injury.



CAUTION

This notice indicates a potentially hazardous situation which, if not avoided, could result in minor or moderate injury, or property damage.



DANGER



Do not open the equipment.

High voltage which can shock, burn or cause death exists inside the equipment. Only qualified personnel should work inside the equipment.



WARNING

Clean the inside of the recorder with the brush supplied.

Carbon accumulated may result in explosion.



WARNING

Do not disassemble or modify the equipment.

Fire, electrical shock or serious injury can result.

Turn off the power immediately if water leaks into the equipment, or the equipment is emitting smoke or fire.

Continued use of the equipment can cause fire or electrical shock.

Do not place liquid-filled containers on the top of the equipment.

Fire or electrical shock can result if a liquid spills into the equipment.

Keep heater away from equipment.

Heat can alter equipment shape and melt the power cord, which can cause fire or electrical shock.

Do not operate the unit with wet hands.

Electrical shock can result.



CAUTION

Use the proper fuse.

Use of a wrong fuse can result in fire or permanent equipment damage.

Power the equipment with the proper power supply.

Powering the equipment with a wrong power supply can cause permanent equipment damage.

Do not use the equipment for other than its intended purpose.

Personal injury may result if the unit is used as a chair or stepping stool, for example.

Do not place objects on the top of the equipment.

The equipment may overheat, or personal injury can result if the object falls.

Remarks on Installation

The FE-881II normally requires 4.5A on 12VDC, 2.3A on 24VDC, or 1.8A on 32VDC. However, it draws a rush current about 8.2A on 12VDC, 6.5A on 24VDC, or 6A on 32VDC recorder when the recorder is turned on or a belt motor is changed to a faster speed (when Basic Range changed to 5/10/20/50 m).

As the power supply cable has a certain amount of resistance between the battery and recorder, the surge current causes the recorder input voltage to drop beyond the tolerance of the recorder operation. The recorder is designed to operate on 10-40VDC under surge condition.

It is recommended, therefore, to use a heavier cable for a longer cable run. The list below gives the guideline for maximum permissible cable run with respect to the cable size.

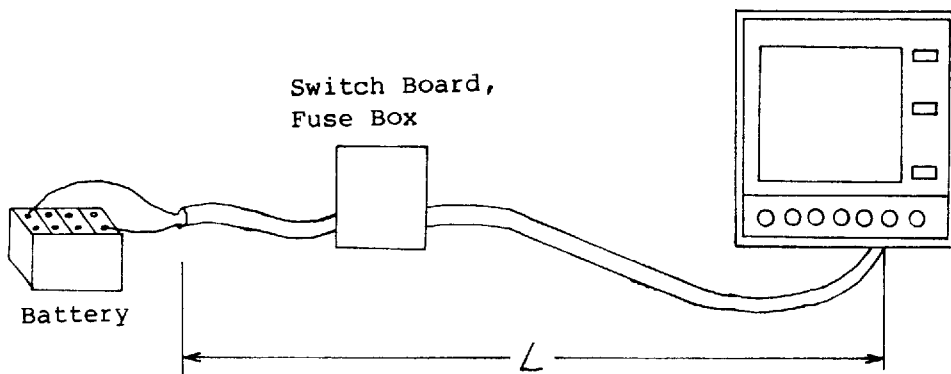

Battery Rating	Cable Type or Norminal Conductor Size Recommended	Maximum Cable Length Permissible
12VDC	2.0 mm ² (US Gauge 14, British Gauge 16)	5 m (15 ft)
	3.5 mm ² (US Gauge 12, British Gauge 14)	10 m (30 ft)
	5.5 mm ² (US Gauge 9, British Gauge 12)	20 m (60 ft)
24VDC & 32VDC	2.0 mm ² (US Gauge 14, British Gauge 16)	20 m (60 ft)
	3.5 mm ² (US Gauge 12, British Gauge 14)	40 m (120 ft)
	5.5 mm ² (US Gauge 9, British Gauge 12)	80 m (240 ft)

CONTENTS

+++++

	<u>Page</u>
OPERATING CONTROL -----	1
HOW TO LOAD RECORDING PAPER -----	2
OPERATING PROCEDURE -----	3
GLOSSARY -----	5
REMARKS ON OPERATION -----	7
HOW TO INTERPRET ECHOGRAM -----	9
What is provided on echogram	9
Variety of Echogram with Echosounder Characteristics	10
Interpretation of Actual Echogram	13
MAINTENANCE -----	19
FUNCTIONAL CHECK -----	21
CABLING DIAGRAM -----	25
RECORDER UNIT OUTLINE DRAWING -----	26
SPECIFICATIONS -----	27

OPERATING CONTROLS

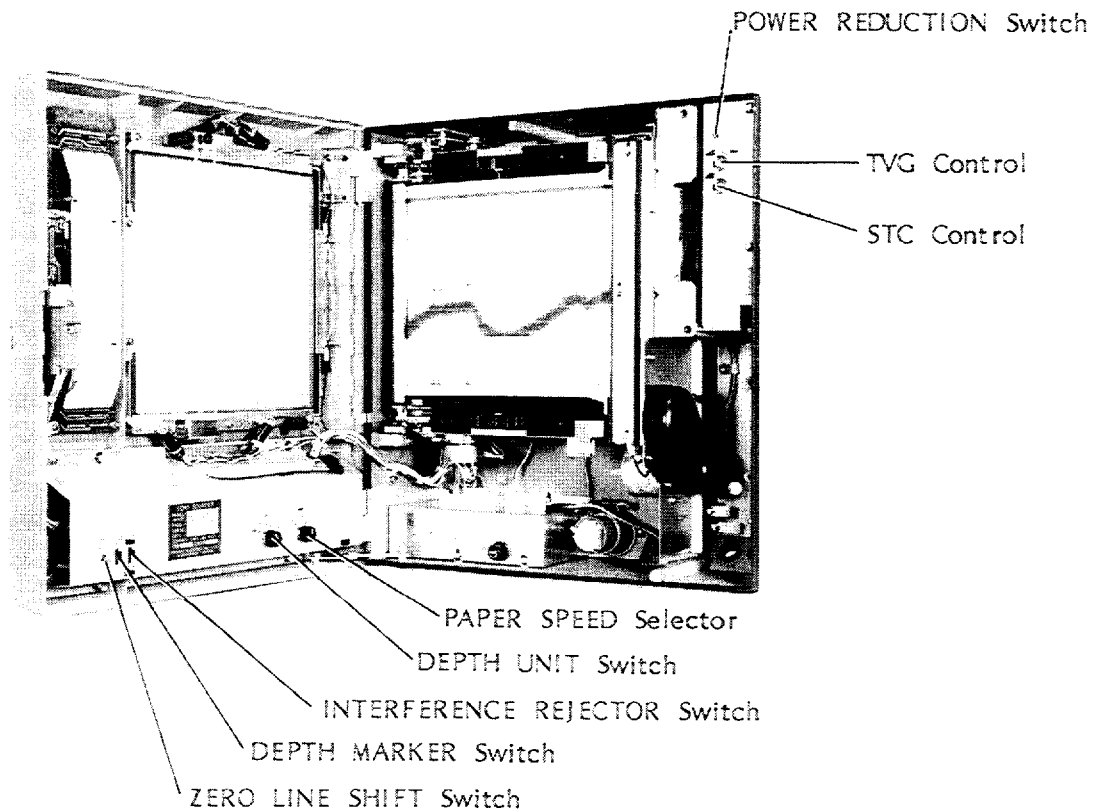
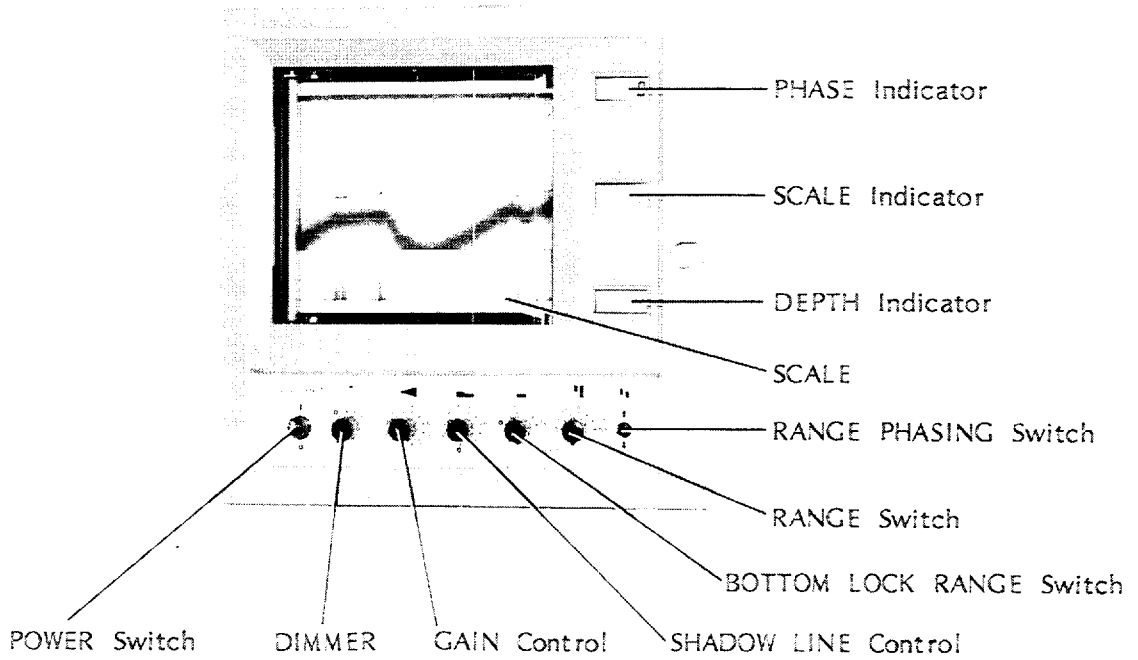
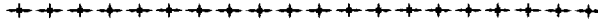

HOW TO LOAD RECORDING PAPER

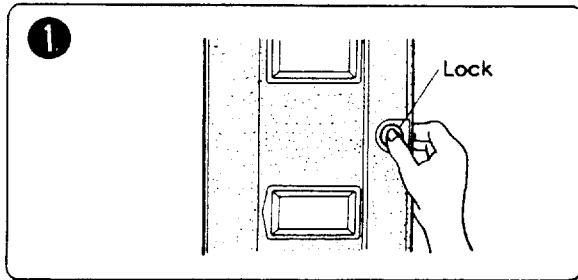
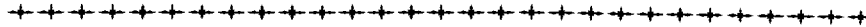

Open cabinet door.

Press the lock on the door to open.

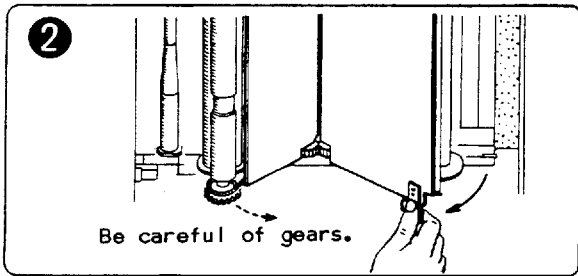

Fold recording plate forward.

Being sure that the recording stylus positions at the back of the recorder cabinet, pull the handle on the recording plate toward you little strongly.

Note: Be careful of the gears not to catch a finger.

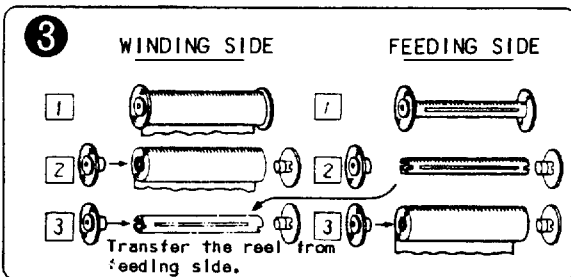

Take out used paper and set new paper.

Take out the used paper from the winding side and the reel from the feeding side, and set a new roll of paper as shown left.

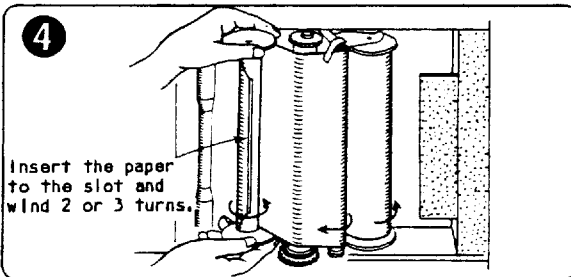

Load paper into recorder cabinet.

Install the new paper to the feeding side and the reel to the winding side. Then insert the paper to the slot of the reel and replace the recording plate.

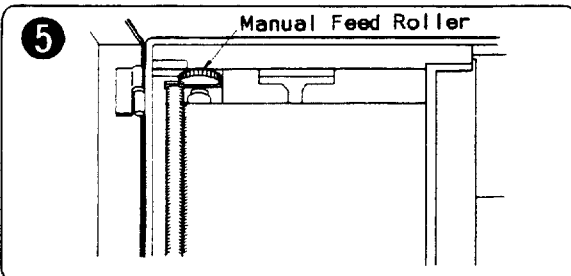

Check paper for proper tension and positioning.

Tighten the slag of paper with the manual feed roller. Check that the paper is not one-sided.

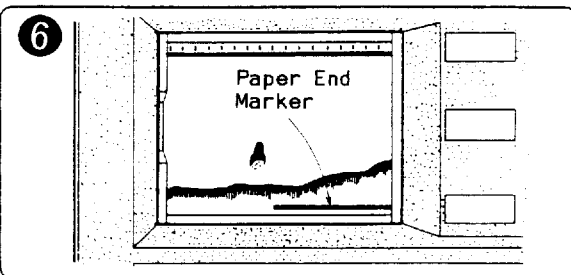

Paper end marker appears.

When the paper runs short, an end marker is seen on the paper. Please replace the paper in good time.

OPERATING PROCEDURE

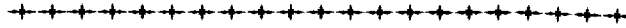

Note: Terms marked with "*" are explained in the glossary on page 5.

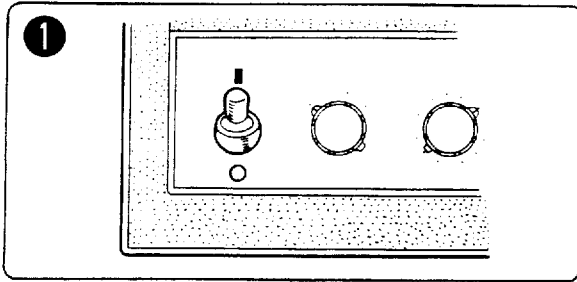

Turn on POWER switch.

Note: Be sure that the recording paper is in position. Operation without the paper will impair the paper feeding roller.

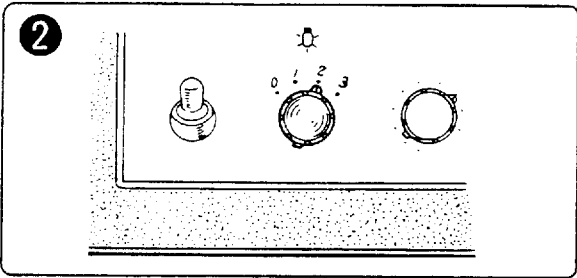

Turn DIMMER to 1, 2 or 3.

The switch adjusts the illumination for the depth readout window, control panel and the recording paper.

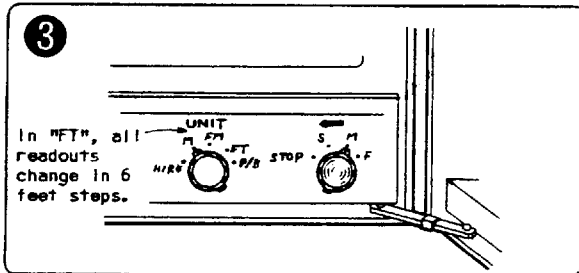

Select depth unit and paper speed.

The paper speed changes in three steps of slow "S", medium "M" and fast "F". In "STOP", the paper and the belt stop with the stylus placed at the back side.

Note: In "STOP", the paper stops but digital readout of sea depth is normally provided.

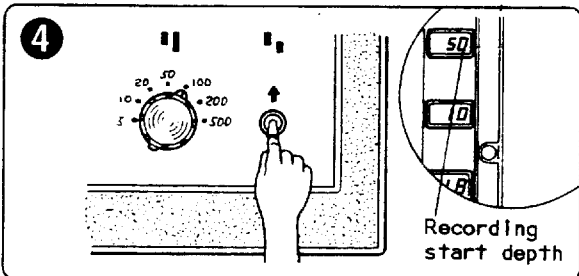

Select recording range.

Select the basic range with and phase it with . Every pressing up or down of shifts the range by one depth unit (6 feet in case of "FT").

Note: The range keeps on shifting while the switch is held pressed; first at a slow rate and then gradually increasing speed.

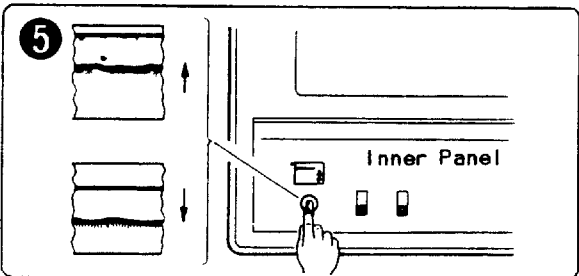

Set record-start-point on paper.

The record-start-point on paper can be moved by the ZERO LINE SHIFT switch , down to 3/4 of paper width.

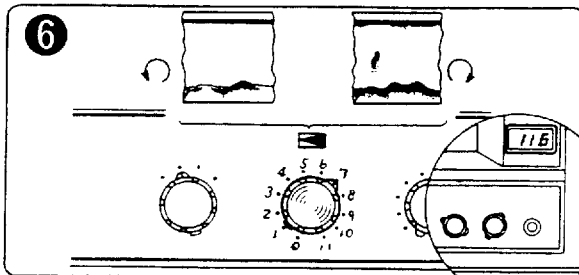

Move the SCALE by hands so that "0m" comes to the upper edge of the zero line.



Adjust Gain*.

Clockwise rotation of the control provides higher gain. When the gain is properly set and seabed echo is sufficiently strong, sea depth is digitally indicated on the lowest indicator.

Adjust TVG/STC* controls.

Adjust the TVG control  for clear seabed and fish traces, referring to the guide mark around the control. If fish traces at shallow water within 10m are jammed by surface noise, adjust the STC control .

Note: Approximate effective range is 70m for TVG and 10m for STC.

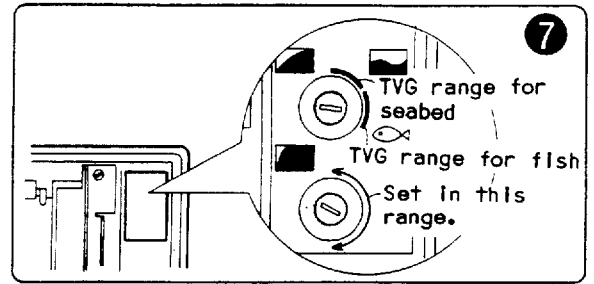

Adjust shadow line* for vivid recognition of bottom fish from seabed.

The shadow line is effected on weaker echoes as the control is turned clockwise. The setting should be touched up whenever the gain setting is altered or sea depth changes.

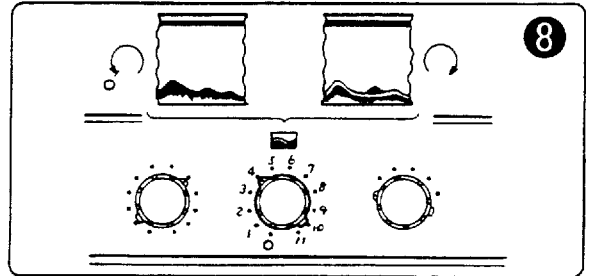

Use bottom-lock expansion for close observation of bottom fish.

Bottom-lock expansion echogram is provided on lower 1/4 of paper width with the range set on the BOTTOM LOCK RANGE switch. The upper 3/4 provides normal echogram.

Note: Stable shadow line should be effected on the seabed to provide bottom locked echogram.

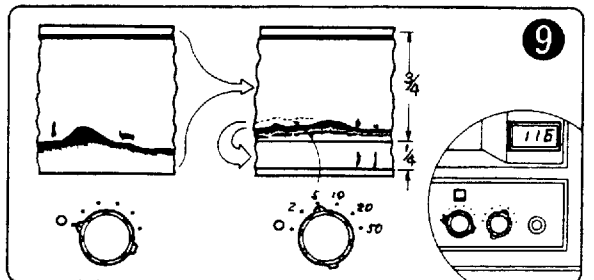



Turn on DEPTH MARKER switch  on demand.

Nine depth marker lines are drawn at depths every 1/10 of the basic range.

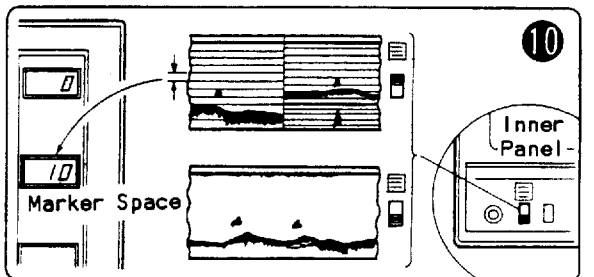
Note: In the bottom-lock expansion echogram, four marker lines are provided.



Turn on interference rejector if necessary.

The interference rejector is on with the switch at . It is recommended to place it at off  when no interference is present.

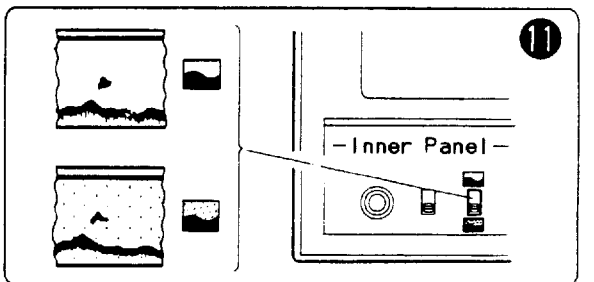

Reduce output power.

In congested fishing ground, it is recommended to prevent interference to other echosounder by reducing output power. In shallow water, reduction in output power is an effective means to make the echogram clear.

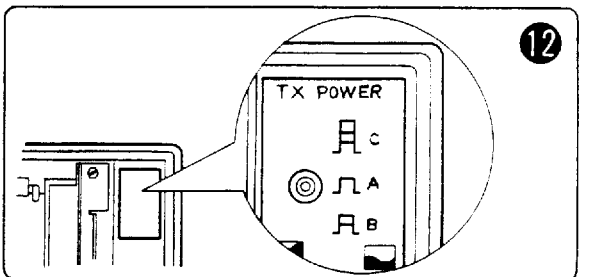

GLOSSARY

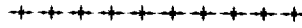

RANGE PHASING

The range phasing is to shift the readout area vertically without changing the range (basic range).

Expanded echogram over a particular area can be obtained even in deep water by combined use of a shorter basic range and range phasing function.

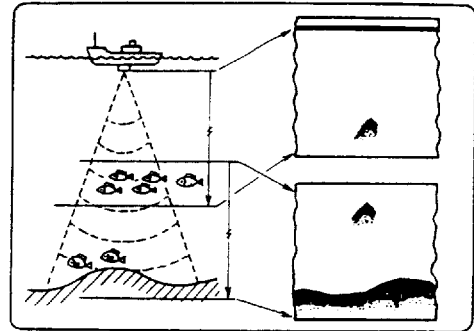

GAIN

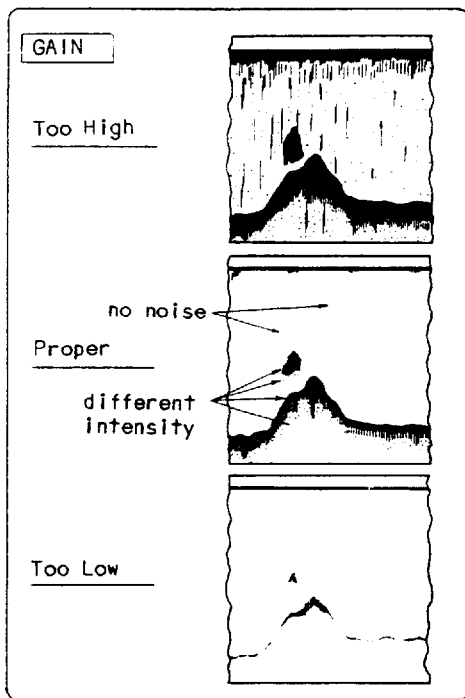

In short, the gain determines the minimum echo level which is received by the echosounder. Clockwise rotation of the GAIN control increases the gain and enables reception of weaker echoes. However the setting should be determined considering the following.

- Too High Gain
Unwanted noises are excessively marked with wanted target echoes being obscured.
- Too Low Gain
The seabed is intermittently recorded and small fish schools may be missed.

INTERFERENCE

There is a case where the echogram is disturbed by interference which appears occasionally or periodically. This is usually caused by such noises as induction from other electric equipments on board, engine noise, ship's vibration and interference from an echosounder of other boats operating in the vicinity in the same frequency band. The built-in interference rejector is a means to remove such an interference. However, if the rejector is not provided, it should be rejected by changing the installation site or moving away from other boats.

Note: The interference which always appears in the same place in synchronism with the transmission cycle of echosounder can not be removed even with the interference rejector.

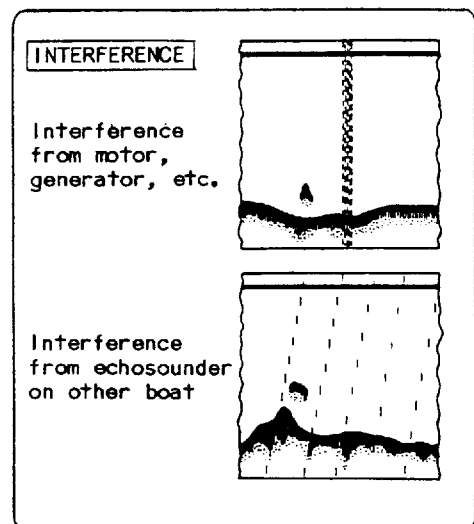

TVG/STC

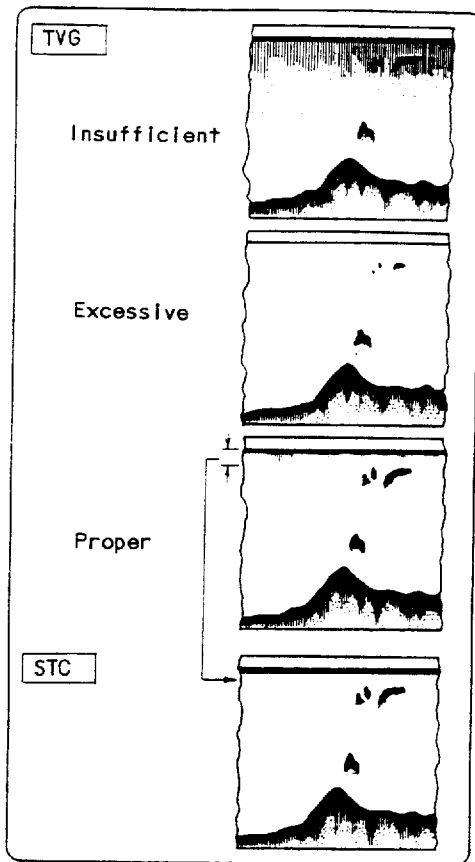

A target at a short range of the transducer returns a comparatively strong echoes even if it is small. However in a long range, ultrasonic wave attenuates and a fish school of the same size is recorded weaker as it lies in a deeper water. TVG is a means to compensate for this disadvantage. It suppresses sensitivity of the receiver for the echoes coming back earlier and gradually increases with time for those coming back later. Changing the sensitivity in this manner helps in reducing surface noise and providing clear and uniform recordings in all depths. Function of STC is similar to that of TVG. Difference is the coverage; STC works mainly for shallow waters while the TVG, for shallow to deep.

SHADOW LINE

Provision for discrimination of bottom fish from seabed is the "shadow line". It distinguishes a fish school from a seabed by utilizing difference in echo strength. With the shadow line function on, the strong echoes from the seabed form a grey "shadow" along the contour and weaker echoes from bottom fish are recorded as traces extending upward from the upper edge of the grey "shadow". The shadow line control on the front determines the echo level above which the shadow line is effected. Its clockwise rotation increases the sensitivity so that the shadow line is applied on weaker echoes. This continuous variable feature is useful not only to discriminate bottom fish but also to judge density of fish school.

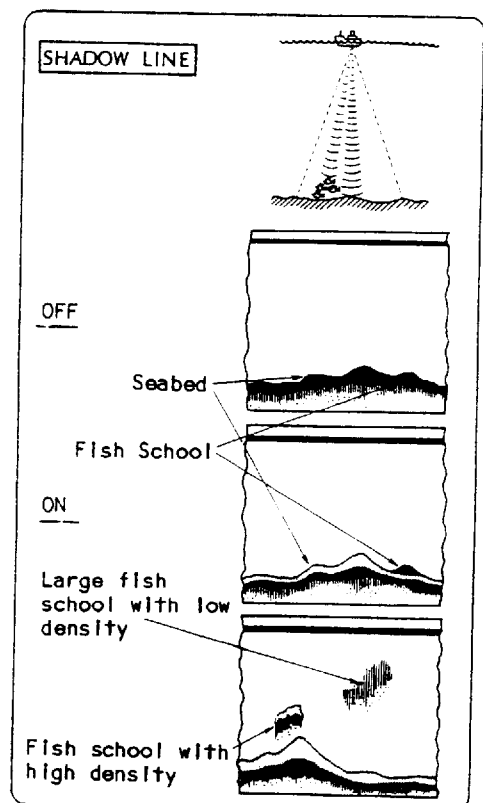

REMARKS ON OPERATION

◆ DIGITAL READOUT OF SEA DEPTH

Sea depth can be digitally read out with the SHADOW LINE control "ON" or "OFF" as follows:

- 1) Adjust the SHADOW LINE control for a stable shadow line effect on the seabed contour, and the digital depth readout is provided.
- 2) When the digital readout is wanted without using the shadow line effect, turn off the SHADOW LINE control and advance the GAIN until the decimal points in the readout window stop flickering. Usually if the seabed echo is strong enough to have the shadow line effect with the SHADOW LINE control at position "9", the digital readout is available with the shadow line "0" (off).

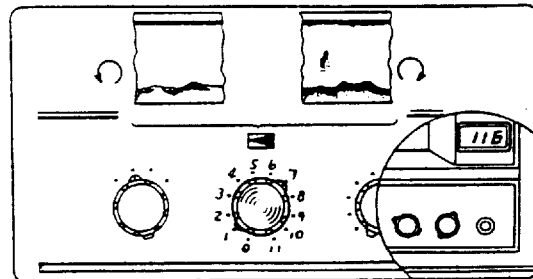
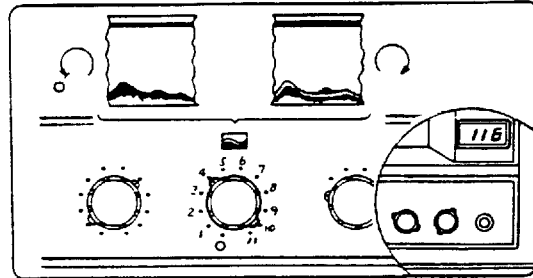

REMARKS

Availability of digital depth indication depends on the presence of seabed echo and the water depth. Following points should be taken into account for safe navigation and true sea depth readout:

- 1) When the power switch is turned on in the water shallower than 3m (4m for 15kHz E/S), the digital display reads out the depth of the 2nd seabed echo and continues to track the false water depth even if the water goes deeper. To cancel this state, turn the SHADOW LINE control to the position "1" or reduce the GAIN control so that the decimal points flicker due to missing of the seabed echo. Then advance these controls to the normal positions to read true sea depth.
- 2) The shadow line function is disabled within 3m (4m for 15kHz E/S). However, if the tail of the transmission line extends 3m (4m), the shadow line is effected to it to read out false sea depth. Suppress this tail by the STC control.
- 3) If the seabed echo is weak or interrupted by air bubbles, false depth is read out with the decimal points flickering.
- 4) When the depth range setting is considerably shallower than the actual sea depth, a false sea depth may be read out by the seabed echo picked-up after the second transmission.

◆ TVG & STC

The effective range of TVG is approximately 70m, while that of the STC changes 0 to 10m. Overall sensitivity is given by the sum of the two.

The settings of the TVG and STC controls changes with frequency and sea conditions. The following shows an example of adjustment for a 50kHz echosounder.

- 1) Set the TVG and STC controls to 1 o'clock positions.
- 2) Advance the GAIN control until the seabed, bottom fish and midwater fish are clearly recorded. Appropriate setting is where slight noises are present.
- 3) First, adjust the TVG control so that echoes deeper than 10m are recorded at a uniform intensity.
- 4) Adjust the STC control so that the echoes within 10m deep are recorded with the same intensity. Especially when searching for surface fish, adjust the STC for clear discrimination of the fish from the transmission line.

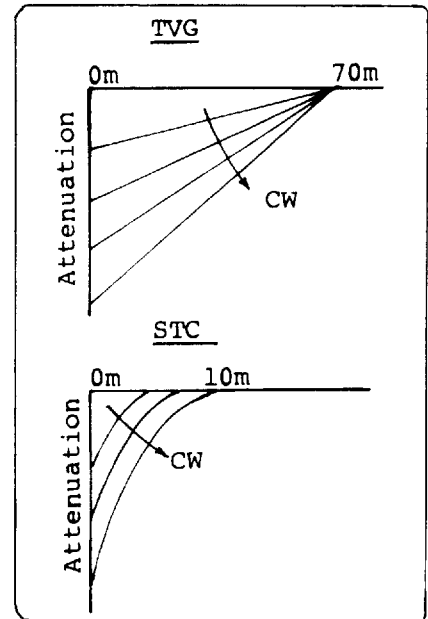

The following is the echogram obtained during sea trial,

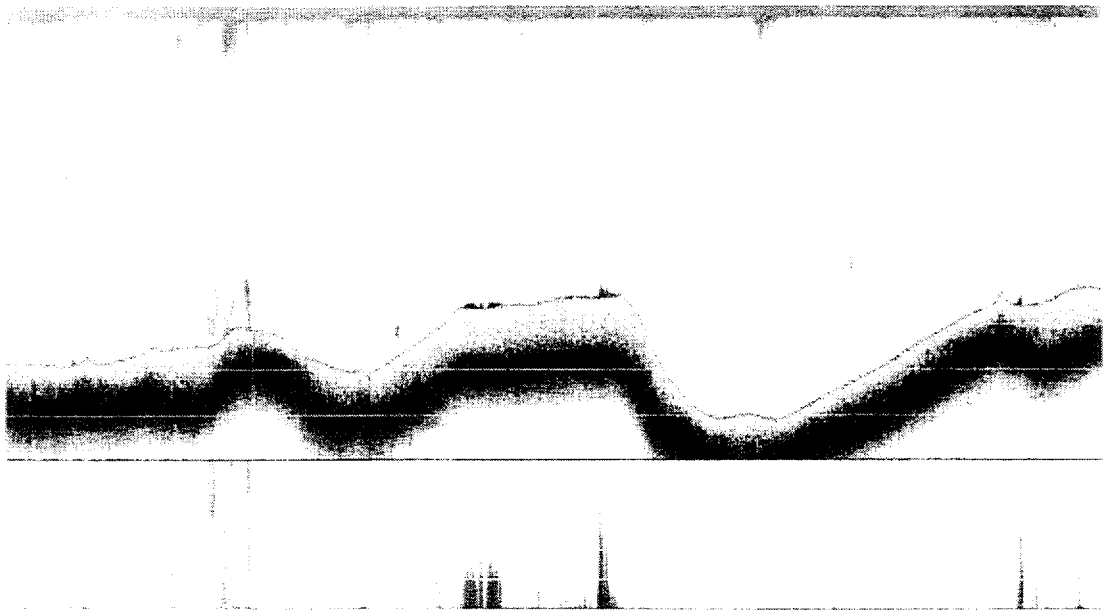

HOW TO INTERPRET ECHOGRAM

WHAT IS PROVIDED ON ECHOGRAM

◆ Transmission Line

The transmission line is a trace of ultrasonic wave emitted into the water. It indicates not the sea surface but the ship's hull bottom where the transducer is installed. To know the depth of a target, ship's draft should be added to the measured depth.

◆ Seabed

The seabed is recorded as comparatively dark trace with some width. The intensity and width vary with the nature of the seabed and characteristics of the echosounder (frequency, pulselength and receiver characteristics).

◆ Fish School

The fish school is recorded between the transmission line and seabed. (The transmission line is not recorded in a phased range setting.) The shape and size of the fish school trace largely depend on the characteristics of the echosounder.

◆ Minute Mark

The minute mark, recorded at 1 minute intervals, is a reference to learn the time lapse.

◆ Recording Range

The area selected with the BASIC RANGE and RANGE PHASING switches are recorded. When the range starts from "0", the transmission line is provided at the top part of the recordings but in a phased range setting as from "60" as shown right, it is not present.

◆ Recording Mode

There are two kinds of modes of "normal" and "normal + bottom locked expansion".

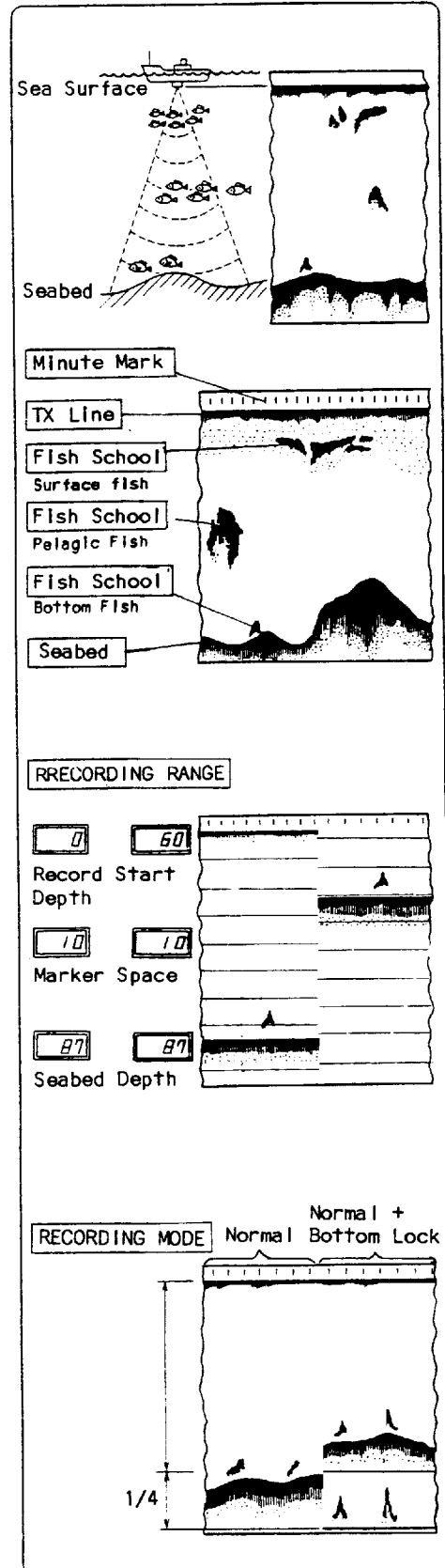

VARIETY OF ECHOGRAM WITH ECHOSOUNDER CHARACTERISTICS

Feature of echogram is affected to a great extent by the characteristics of the echosounder.

◆ Frequency

Characteristics of ultrasonic pulse vary as tabulated below with its frequency, and provides a different type of echogram.

Characteristics, Application	Low Frequency	High Frequency
Beamwidth*	Wide**	Narrow
Sounding Depth	Deep	Shallow
Resolution***	Poor	Good
Affection of Air Bubbles and Water Noise	Large	Little
Suitable Application	<ul style="list-style-type: none"> •Wide area searching •Bottom discrimination 	<ul style="list-style-type: none"> •Identification of fish school density •Discrimination of bottom fish

*Sound pressure of ultrasonic wave is strongest at the center of the beam and goes weaker gradually in the outer part. The beamwidth is the angle of conical beam measured at half pressure points of ultrasonic wave. (Echoes outside the beam can also be recorded if the reflection is strong)

**The beamwidth is, strictly speaking, determined by the size of transducer face. Even in low frequency, it becomes narrower if two or more transducers are placed side by side.

***Ability to distinguish two fish schools closely located at the same depth.

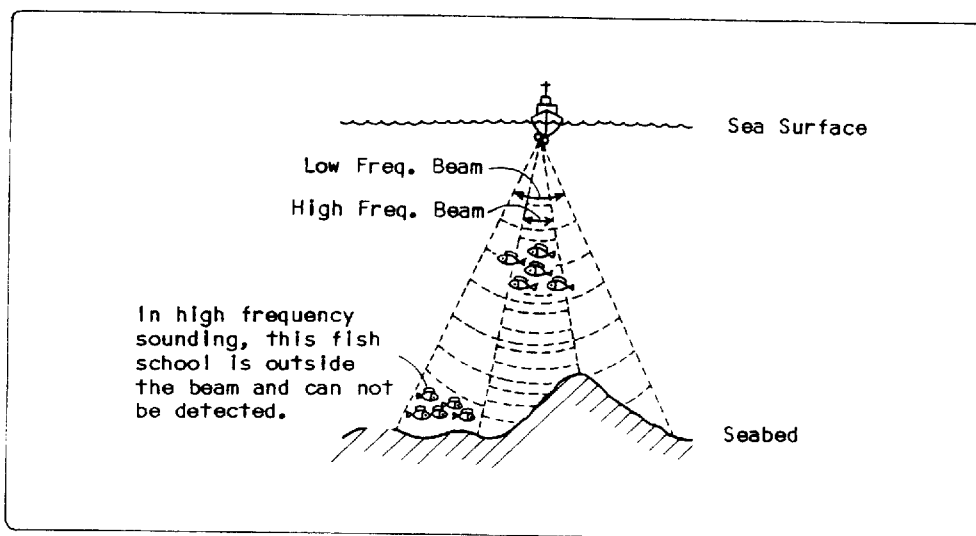

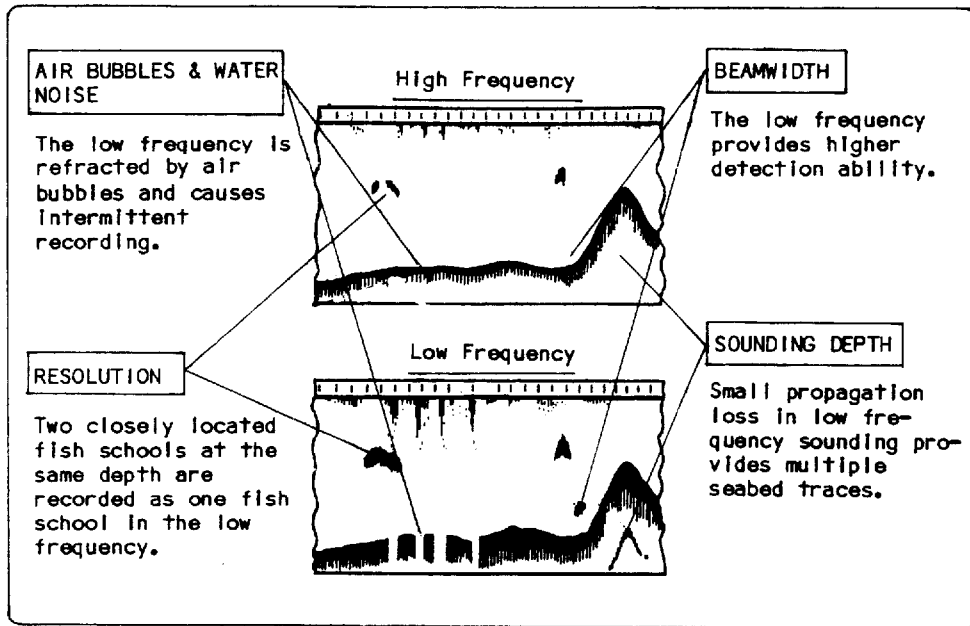

◆ **Pulselength**

Characteristics of echogram change with pulselength as follows.

Pulselength	Short	Long
Feature, Application		
Range Resolution*	Good	Poor
Sounding Ability**	Poor	Good
Suitable Application	<ul style="list-style-type: none"> • Discrimination of fish distribution • Identification of bottom fish 	<ul style="list-style-type: none"> • Deep sounding • Detection of small fish school

*Ability to distinguish two fish schools closely located at different depths.

**Sounding depth and ability to detect small target.

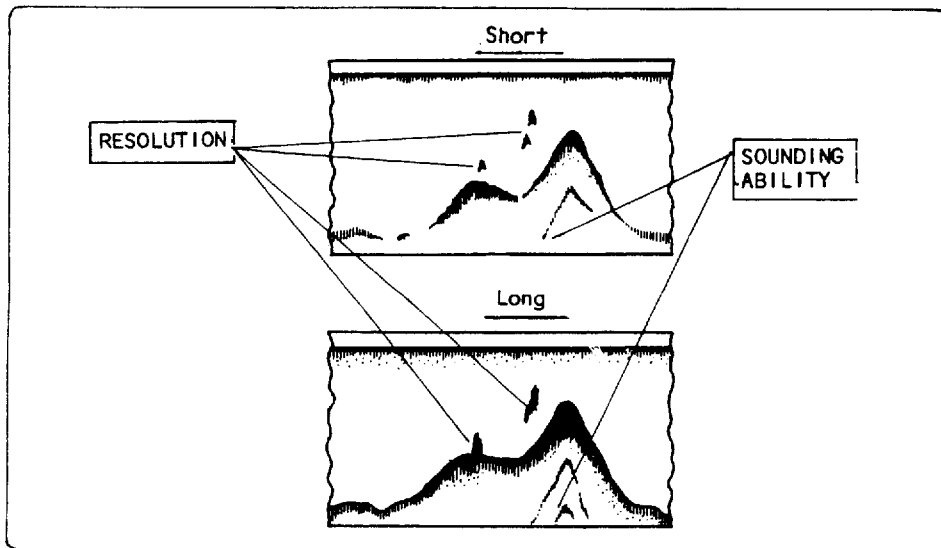

◆ **Sounding Rate and Paper Speed**

Paper speed and sounding rate are closely related to the density of recordings. The slower paper speed and higher sounding rate make the recording higher in density.

Since characteristics of fish school trace or seabed trace on the echogram change with paper speed and ship's speed as shown below, they should be taken into account for interpretation of the echogram.

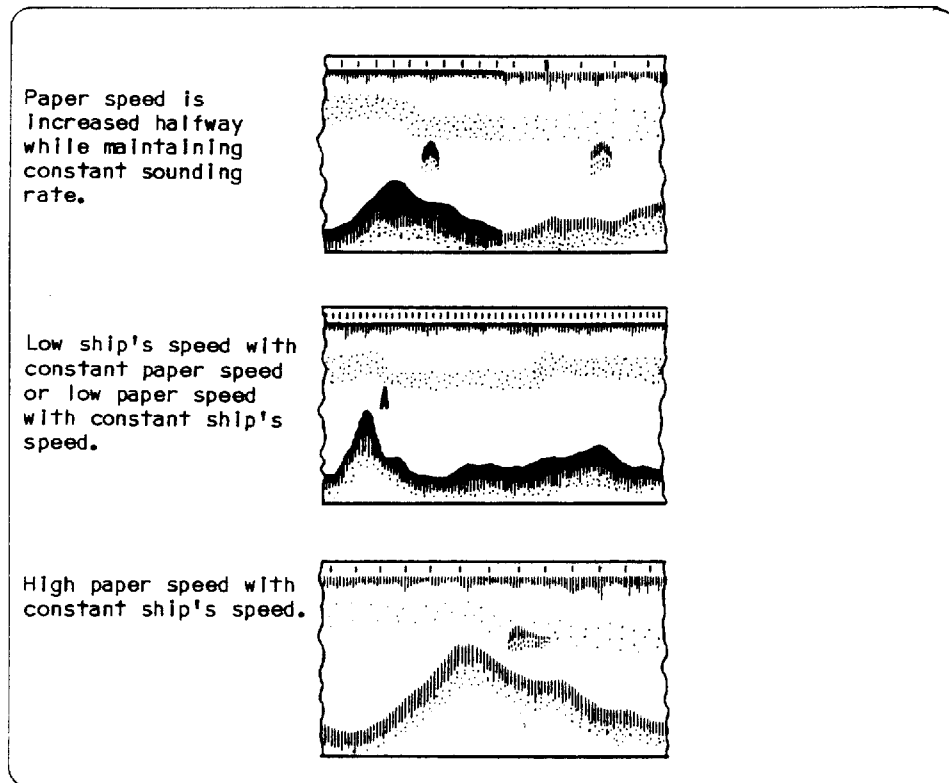

INTERPRETATION OF ACTUAL ECHOGRAM

Careful study of an echogram gives much information useful in fishing such as fish species, fish quantity, fish school density and characteristic of seabed. The following shows some examples of echograms obtained during actual fishing and descriptions for them are attached.

◆ Fish Species

The shape, size and density of traces for a particular species of fish are not always constant but vary with differences in sea condition and echosounder characteristics. However, comparison and investigation of many echograms obtained in the same area, in addition to knowledge of fish habit, lead to find that each species of fish provides distinctive echo trace.

Sardine, Mackerel/Horse Mackerel

Sardine is a comparatively small fish which inhabits near the plankton layer in shallow and mid waters, forming a large school. Its trace is mostly distinguishable from dense top part followed by uniform and little weaker lower part. Horse mackerel and mackerel provide similar traces to that of sardine and their discrimination is difficult if sardine is involved in their schools. When they are separate from sardine, they usually inhabit at a deeper water and hence can be distinguished from this point.

Bonito

Large fish like bonito and tuna return stronger echoes than small fish like sardine. However, because of high speed and lower concentration of their school, their traces become sparse as shown.

Sea Bream

Sea bream inhabits mostly close to rock pile and is recorded as triangular or rectangular trace with round outline.

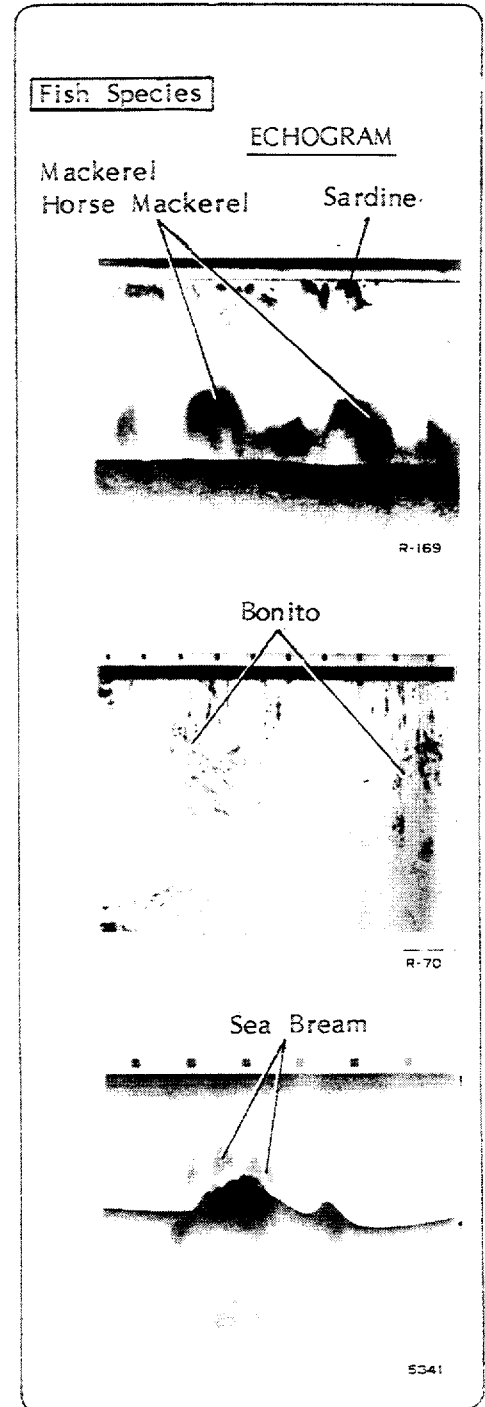

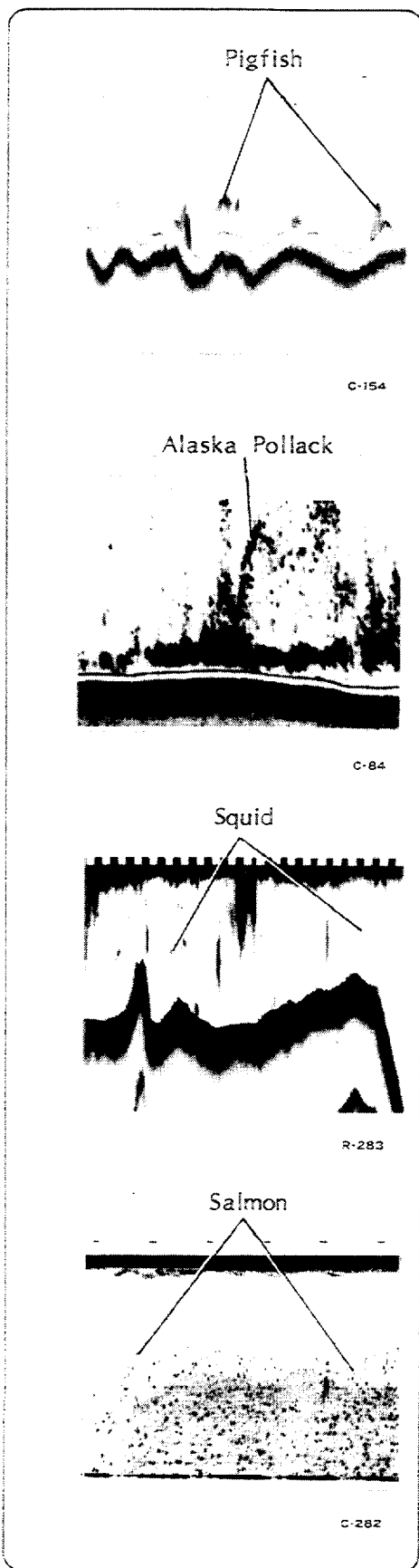

Pigfish

Pigfish is a bottom fish which forms a school near a craggy seabed of rock, and shows a trace different from that of sea bream. In the echogram shown, the fish is seen just on the seabed, but echograms showing the fish off the seabed have also been obtained. The shadow line feature is effective especially for the fish staying near craggy seabed.

Alaska Pollack

Alaska pollack leaves traces similar to those of plankton layers (described on the following page) except that individual dots of a trace are bigger and registered on or near the seabed over a wide area.

The shadow line feature is effective for alaska pollack too.

Squid

It is commonly known that squid is difficult to detect by an echosounder because of its low reflection coefficient. It is registered with the size of match head as shown left only when forming a comparatively large school. However in recent days, the detection is becoming harder due to decrease in its population.

Salmon

Salmon is recorded at shallow depth, usually less than 30m, as a crowd of points similar to those marked by a pencil a little densely.

Above are only examples of echograms. In addition to these, spanish mackerel, saury, etc., provide respectively distinctive traces.

◆ Fish Quantity/Fish School Density

Quantity of fish can be estimated to a certain extent from traces of fish school. Estimation is based on the following two factors:

★ Size of Fish School Trace

Since size of fish school trace is proportional to the size of actual fish school, it can be used as a basis. However, it should be taken into account that if two traces appear at different depths with the same size, the fish school at shallower depth is actually bigger than that at deeper depth.

The sounding beam of an echosounder is conical. This indicates that a fish school in a deeper water is hit by the beam for an extended period of time and leaves a wider trace, that is, the trace becomes bigger than the actual size of fish school.

★ Intensity of Fish School Trace

Intensity of the trace is the other basis to estimate fish quantity. In two fish schools of the same size, densely concentrated fish school returns stronger echoes and provides darker trace. However, it should also be kept in mind that if two traces are recorded at different depths with the same intensity, the fish school at a deeper place is more densely concentrated.

Since the ultrasonic wave attenuates as it propagates, the trace of a fish school in a deep place becomes weaker than that in shallow place even if they reflect the same amount of wave.

◆ Plankton (DSL) Layer

Weak cloud-like layer is sometimes registered between the transmission line and the seabed. It is a mass of micro organism called plankton (DSL). Since fish gather to feed on it as a bait, fishing operation of some species of fish is conducted by just observing this trace rather than the trace of fish school. Usually the plankton layer lies in deep water by day and rises to shallow water at night.

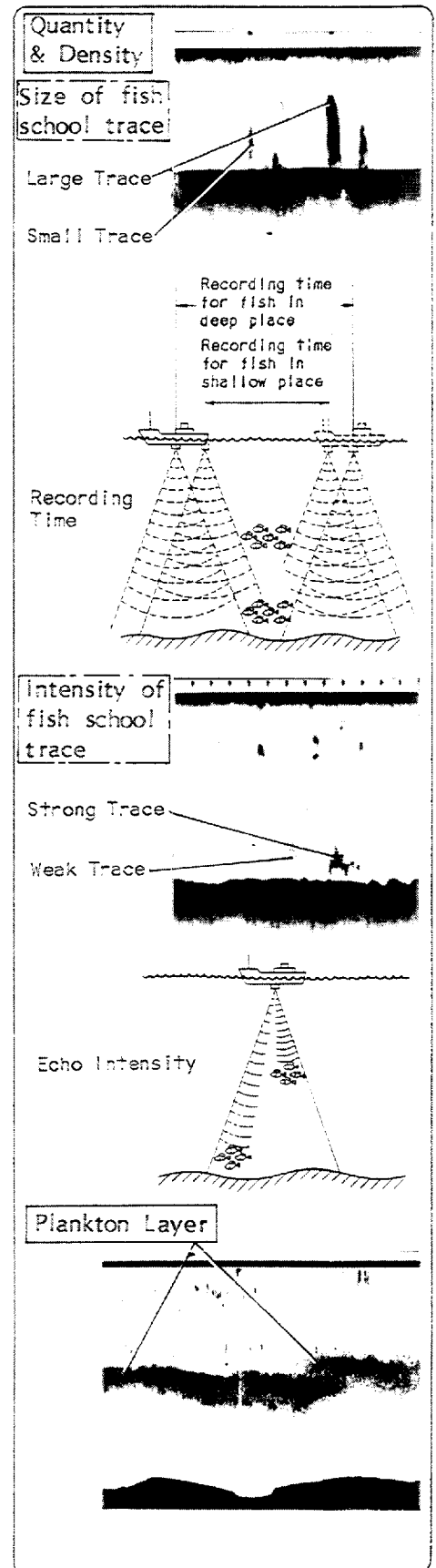

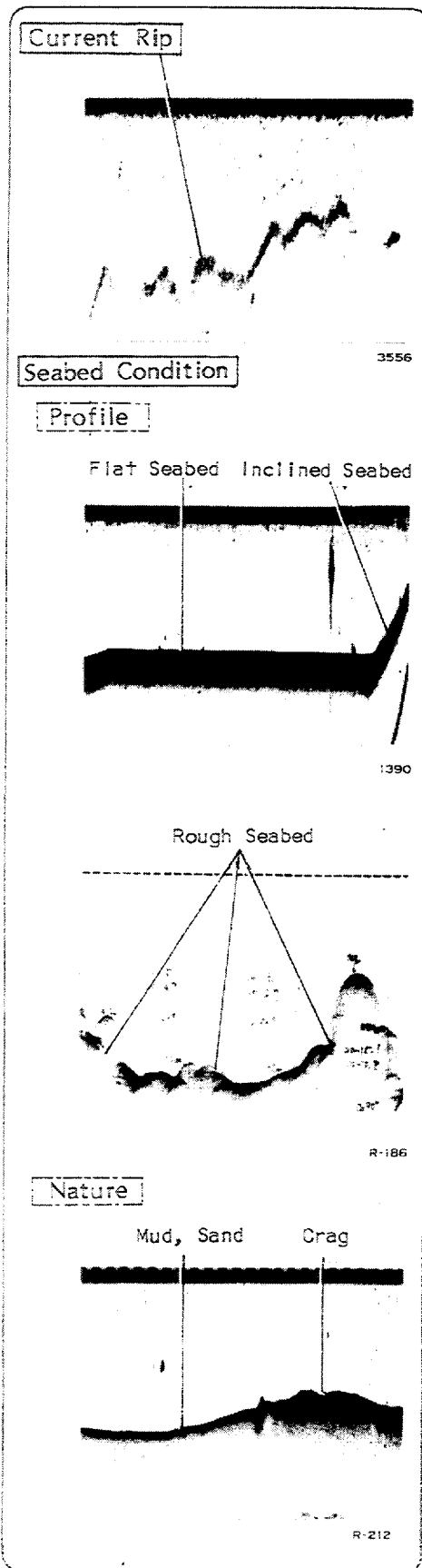

◆ **Current Rip**

Trace which can be mistaken apparently as noise is plotted in the place called current rip, where two ocean current meet with different speeds, directions and water temperatures each other. This noise-like trace is either air bubbles or plankton layer. Since fish gather there in search for bait, discrimination of the current rip is an important means for finding out a fish school.

◆ **Seabed Condition**

It is well known that abundant information useful for fishing is obtained from seabed trace on the echogram. For example, rock piles and wrecks are the places where fish gather.

★ **Seabed Profile**

- Flat seabed with uniform nature --Recorded as a trace of constant width.
- Inclined seabed/slope of rock pile --Recorded as a trace with long tail because ultrasonic wave is reflected in different depths.

Note: The tail becomes longer but since the seabed is inclined, apparent width of the seabed trace is narrower.

- Rough seabed --Since echoes return from various directions, they overlap each other and leaves perspective trace.

★ **Nature of Seabed**

Nature of seabed is known from intensity and length of tail of seabed trace.

- Hard } ----- Dense trace with long tail
- Craggy } -----
- Mud, sand, alga == Faint trace with short* tail

* Bottom of sediment may give a long tail if a low sounding frequency is used.

For bottom discrimination, wide beamwidth (low frequency) and long pulse length are suitable. Further, since the discrimination is done by relative comparison of traces, the gain setting should be kept unchanged.

So far, descriptions are made on the traces useful for fishing. However, unwanted and unuseful traces sometimes appear as below.

◆ **Multiple Reflection**

In a comparatively shallow water with hard seabed, the second or further multiple seabed traces are recorded. These are caused by multiple reflections of the sounding pulse at the seabed and the sea surface; the echoes coming back from the seabed are reflected by the sea surface and go down again to the seabed and then return.

The true depth of water is the interval from zero line to the first seabed trace, and the second or third one is recorded with the almost same interval as that of first one.

The multiple reflection is useable for rough check of transmission power and amplifier sensitivity.

◆ **Sea Surface Noise**

Sea surface noise is plotted near the transmission line when the sea is rough or when crossing over the wake of other boat. The cause of the noise is mainly air bubbles.

Proper setting of the STC control serves to minimize the sea surface noise, allowing distinct echogram.

◆ **Interruption of Recording by Air Bubbles**

In a rough sea, there is a case that the echogram is occasionally interrupted due to below-the-ship air bubbles obstructing the sounding path. It also occurs by wake when the ship makes quick turn or backward movement.

It is quite difficult to eliminate the interruption, especially in low sounding frequency. Reconsideration on installation site of the transducer is needed if the interruption occurs frequently.

◆ **Zig-zagged Bottom Trace**

The seabed is recorded zig-zag like the teeth of a saw in a rough sea. This is caused by rolling and pitching of the ship, thereby the sounding direction fluctuates and the distance to the seabed varies.

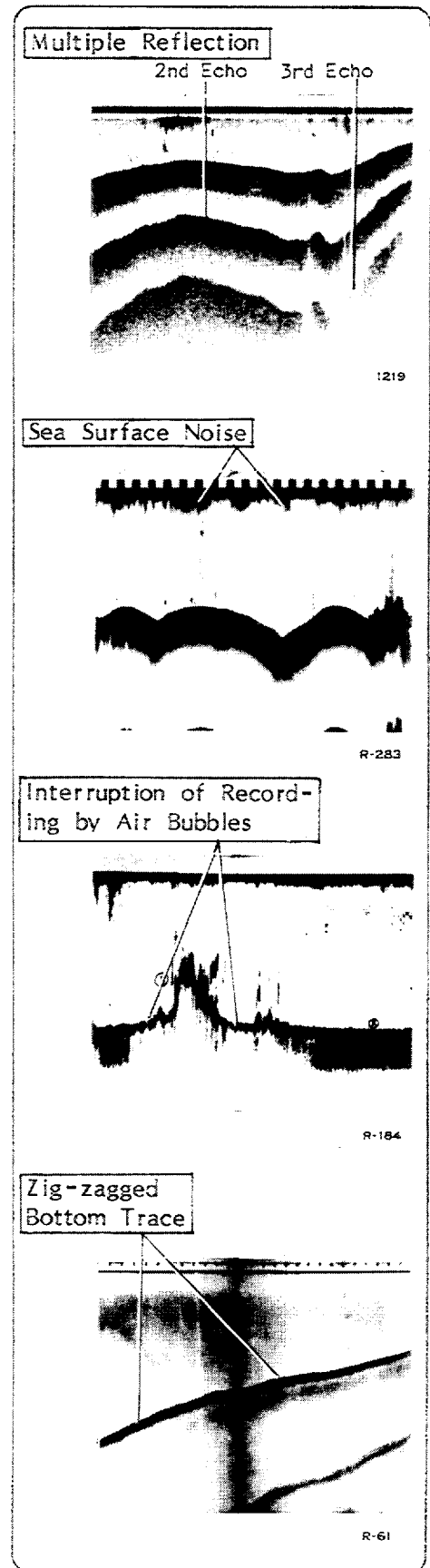

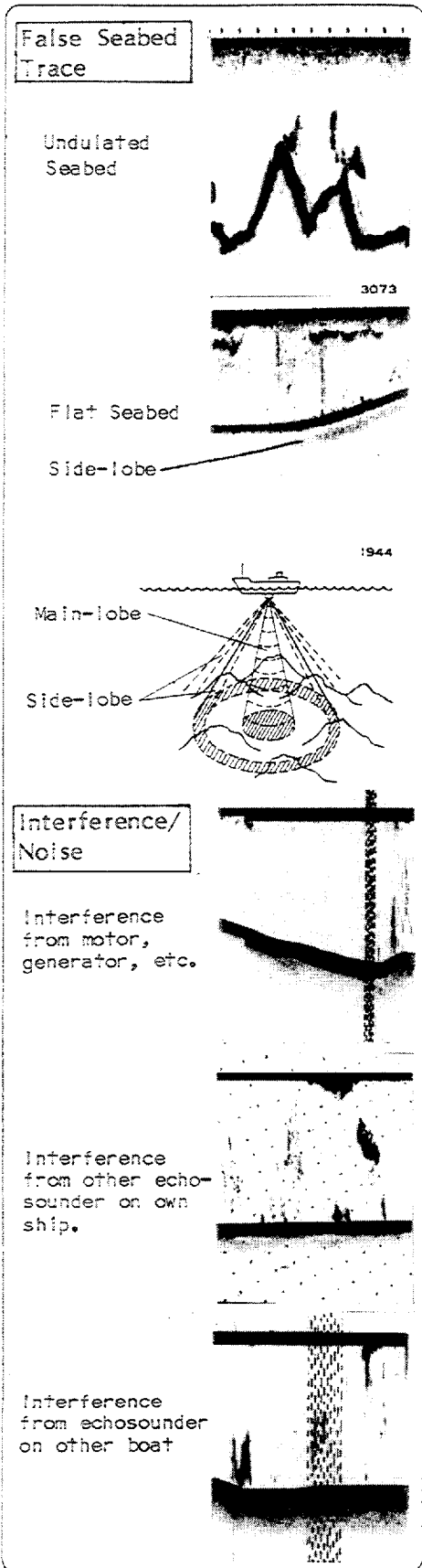

◆ False Seabed Trace

In the seabed with sharp gradient or high undulation, blurred trace will sometimes appear above the seabed contour, while in the flat seabed, it is recorded below the contour. They are false echoes caused by side-lobe of ultrasonic beam.

So far, it is explained that ultrasonic wave is radiated only in the vertical direction as a beam (main-lobe), but in practice, there are some beams outside the main beam that are called "side-lobe". Energy of the side-lobe is fairly weak but it still can provide trace if the reflection is strong.

◆ Interference/Noise

Since descriptions for interference and noise are provided on page 5, some of their echograms are presented here.

MAINTENANCE

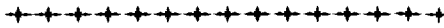

Free from water splash and stain?



Do not use thinner and benzine!

Wipe off stain and salt on the surface with moist duster and then rub with dry cloth. Put on vinyl cover when the set is not used.

Be careful not to hurt the set!



Flaw will cause corrosion!

Heater is not placed in the vicinity?
Well ventilated?



Electronic equipment does not like high temperature!

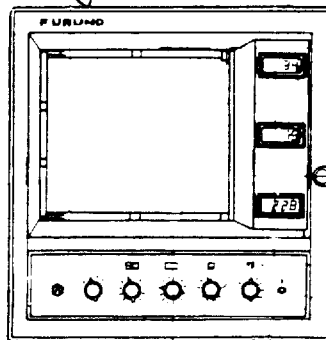

 **CAUTION**

Understand the notes on this page before doing maintenance.

Transducer face is kept clean?

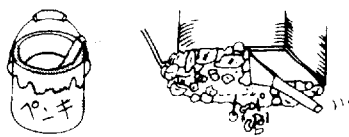

Do not paint transducer face!

Oysters and other shells attached to the transducer face deteriorate the transducer performance. Gently remove them when dry-docked.

No abnormal noise from mechanical part?



Do not jam rubbish in the gears.

Be careful not to jam paper, thread or rubbish in the gears when replacing recording paper or cleaning inside. Grease mechanical part once every 3 or 4 years.

No stain on collector rail or paper feeding roller?

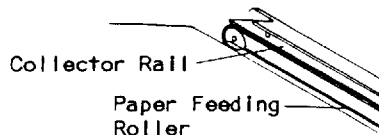

Stain on collector rail and flaw of paper feeding roller deteriorate quality of echogram.

No carbon accumulated inside?

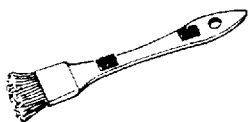

Carbon accumulates with time. Clean the inside with the brush supplied.

Recording stylus is worn away?

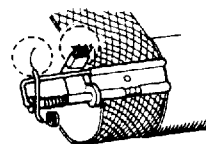

Worn stylus obscures echogram!

HOW TO REPLACE RECORDING STYLUS

① Turn belt by hand along arrow until recording stylus comes out.

② When only the stylus nib is worn, pull out the nib and cut off the worn part. The proper length of nib is about 10mm. If it is too long, the recording becomes weak.

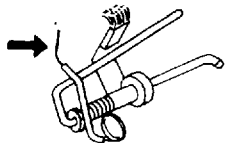

③ When the collector brush is worn, take out the stylus by pushing it along arrow (↑) and replace it with new one.

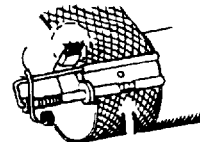

④ Being sure that the recording paper is in position, put sand paper as shown and turn the belt about 20 times to round the stylus nib.

FUNCTIONAL CHECK

※ Please perform following check before requesting repair.

- When the set is found faulty, do not attempt further troubleshooting and call for repair by a skilled service technician.

◆ No Recording (Belt not rotating)

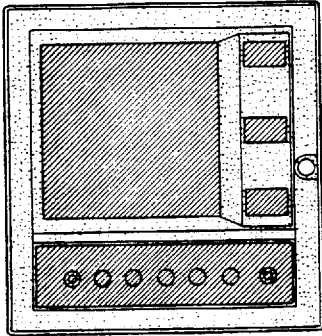

- ★ Nothing at all with power on.
 - Fuse is OK?

If the fuse is blown, replace it with new one. In case it blows again, call for repair.

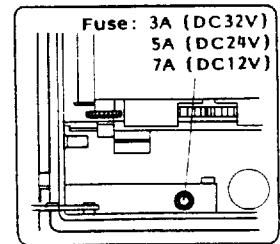

- ★ Supply voltage is normal?

Check that dc voltage of 10 thru 40V is present between #1(+) and #2(-) of the power supply terminal.

- ★ Fuse blows shortly after power on.
 - Belt jammed?

Check the belt for strange materials (scrap of paper, rubbish) which will overload the motor, leading to blown fuse.

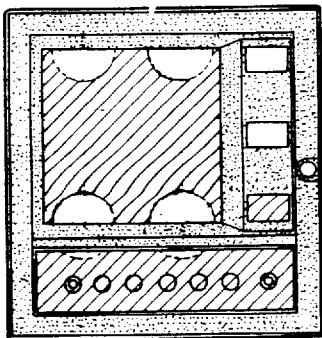
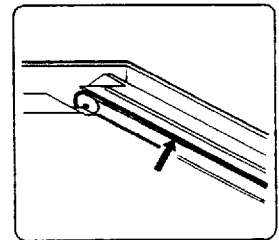

- ★ Illumination lamps flicker and belt speed remains constant regardless of the range setting.
 - Supply voltage is normal?

Check the supply voltage in the same manner as above.

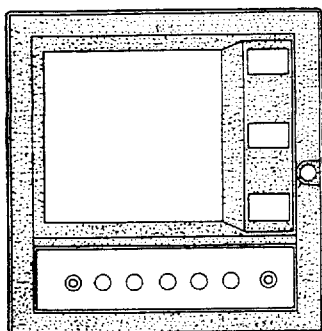
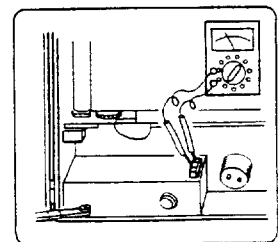

- ★ Illumination lamps light at normal brightness but belt does not rotate.
 - PAPER SPEED selector is in correct setting?

Set the PAPER SPEED selector to "S", "M" or "F".

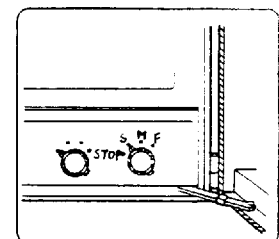

◆ Abnormal Recording

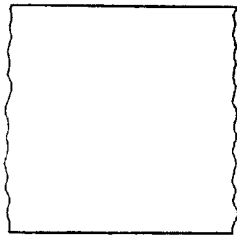

- ★ Belt rotates but no recording.
 - Recording stylus is set in position?

Refer to "How to replace recording stylus" on page 20.

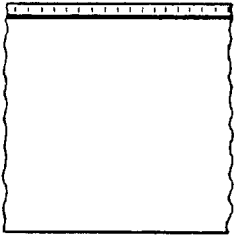
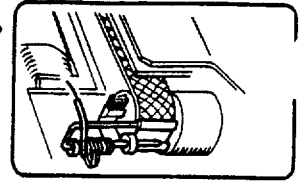

- ★ Transmission line plotted but no echo trace.
 - No loose connection at the transducer terminals?

When the connection is loose, tighten it firmly to avoid further loosening.

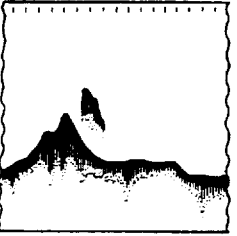
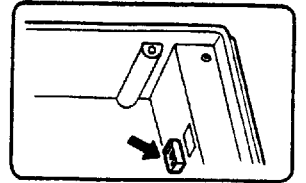

- ★ Normal recording for minute mark and target echoes but no transmission line.
 - Phased range is used.

The transmission line is recorded only when the recording start depth is 0 or around.

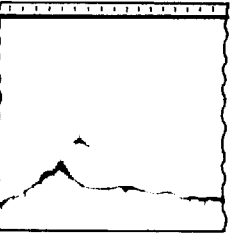
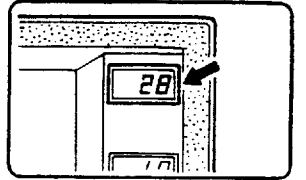

- ★ Obscured seabed and fish school due to low sensitivity.
 - Sea is not rough?
 - Output power is reduced?

Rough sea and reduced power lowers detection capability. Operate at full power when it is not necessary to care about interference to other boats.

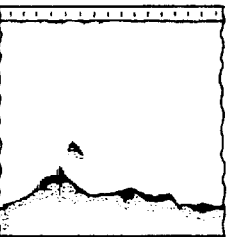
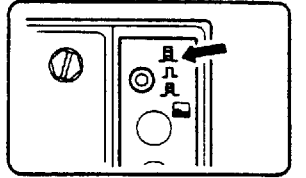

- ★ Weak recording as a whole.
 - Recording stylus is worn away?

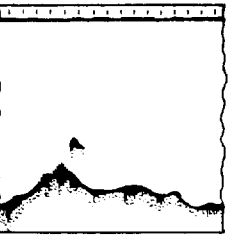
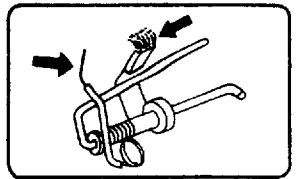

- ★ Uneven recording in intensity
 - No strange material on the stylus nib?
 - No stain on the collector rail?

The recording stylus, collector rail and paper feeding roller should be kept clean all the time.

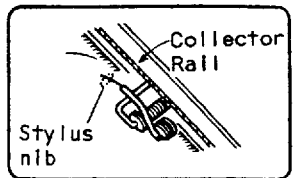

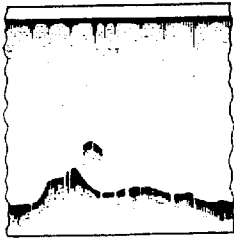

★ Intermittent recording.

- Sea is not rough?
- Ship is not under way of quick turning?

In addition to above, the intermittent recording will result when the ship is going astern or crossing over the wake of other boat. Alteration of transducer installation site may be required if the recording is intermittent all the times.

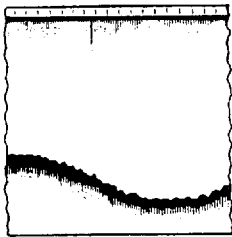
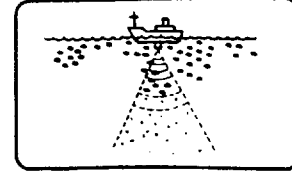

★ Bottom contour recorded zig-zag.

- Sea is not rough?

It is an affection of pitching and rolling. When the transducer is installed along ship's sideboard, check also that the pipe is securely fixed.

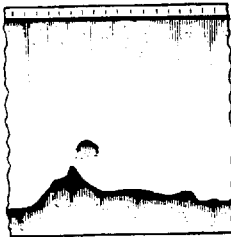
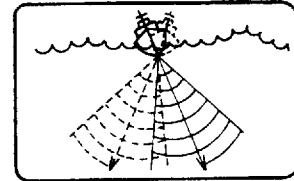

★ Excessive surface noise.

- STC is adjusted properly?

Quantity of surface noise depends on sea condition (rough or calm). STC should be kept adjusted in accordance with existing sea condition.

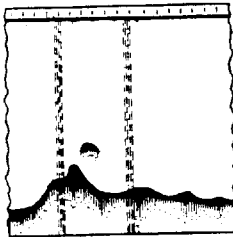
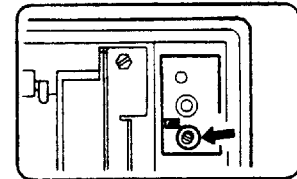

★ Irregular noise appears at times.

- It comes from other electric equipments.

Turn off the electric equipments in the neighbour one by one, especially the ones with brush such as rotary inverter and generator, to locate noise generating source. Keep the echosounder and its wiring off the source.

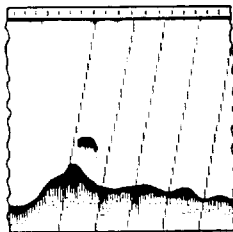
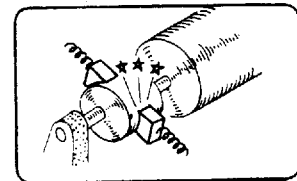

★ Noise appears periodically.

- Any fishing boat operating in the vicinity?

Turn on the Interference rejector.

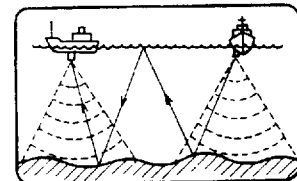

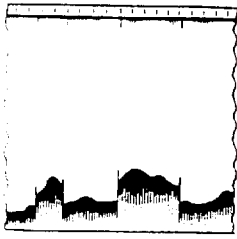

★ Minute mark interval irregular.

- Recording paper is set in position?

Set the recording paper again, referring to "how to load recording paper" on page 2 and check paper feeding condition by turning manual feed roller.

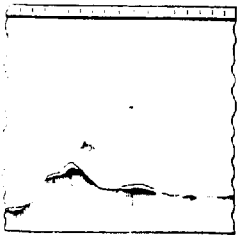
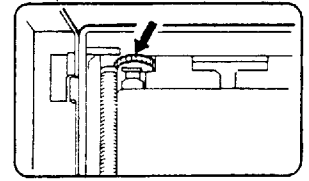

★ No or intermittent shadow line effect.

- Gain not too low?
- Output power is full?

The shadow line is not effected if the gain is low. Try to increase the gain.

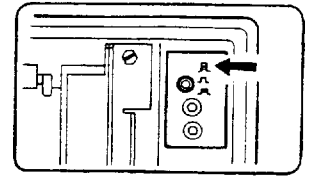

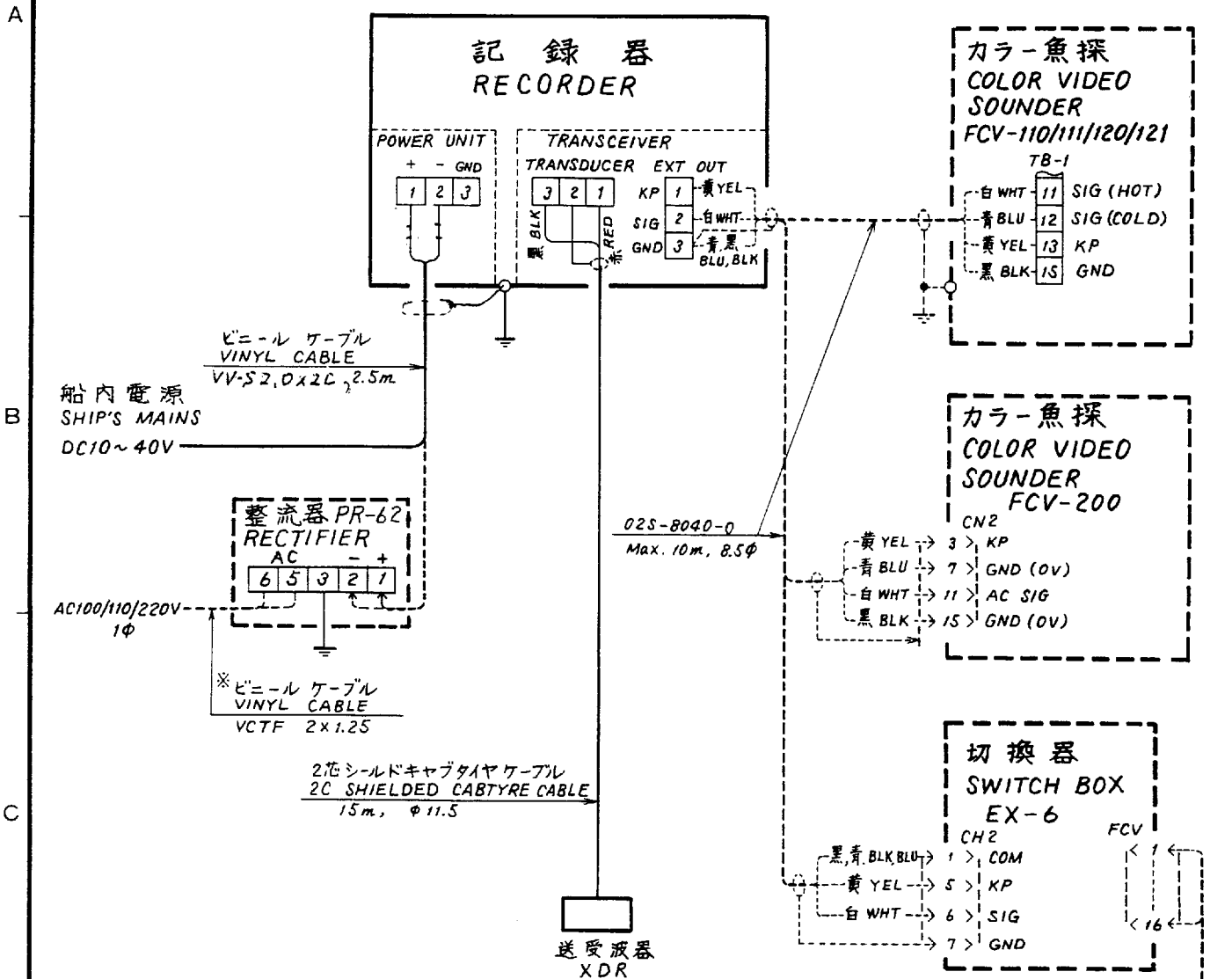

バッテリー 記録器間最大許容ケーブル長
 MAXIMUM PERMISSIBLE CABLE LENGTH BETWEEN
 BATTERY AND RECORDER UNIT

バッテリー BATTERY	ケーブルサイズ CONDUCTOR SIZE	最大許容長 MAX PERMISSIBLE LENGTH
12VDC	2.0mm ²	5m (15ft)
	3.5mm ²	10m (30ft)
	5.5mm ²	20m (60ft)
24VDC & 32VDC	2.0mm ²	20m (60ft)
	3.5mm ²	40m (120ft)
	5.5mm ²	80m (240ft)

カラー魚探
 COLOR VIDEO
 SOUNDER
 FCV-200/
 201

NOTE
 1. ----- : オプション
 OPTION
 2. ※ : 造船所支給
 SHIPYARD SUPPLY

品番 ITEM	品名 NAME	材質 MATERIAL	数量 Q'TY	図番 DWG. NO.	摘要 REMARKS
承認 APPROVED	Nov. 17 1981 K.K.	三角法 THIRD ANGLE PROJECTION	名称 TITLE	相互結線図 CABLING DIAGRAM	
検図 CHECKED	尺 SCALE	重量 WEIGHT	kg	図番 DWG. NO.	FE-881 FE-881II C2272-001-E
製図 DRAWN					

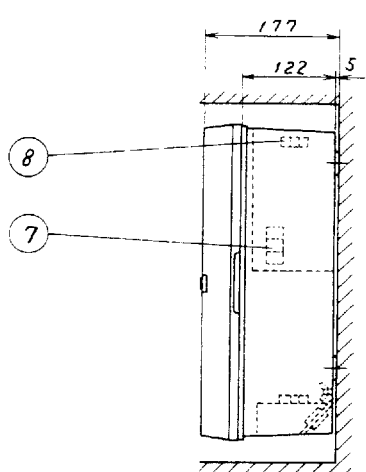
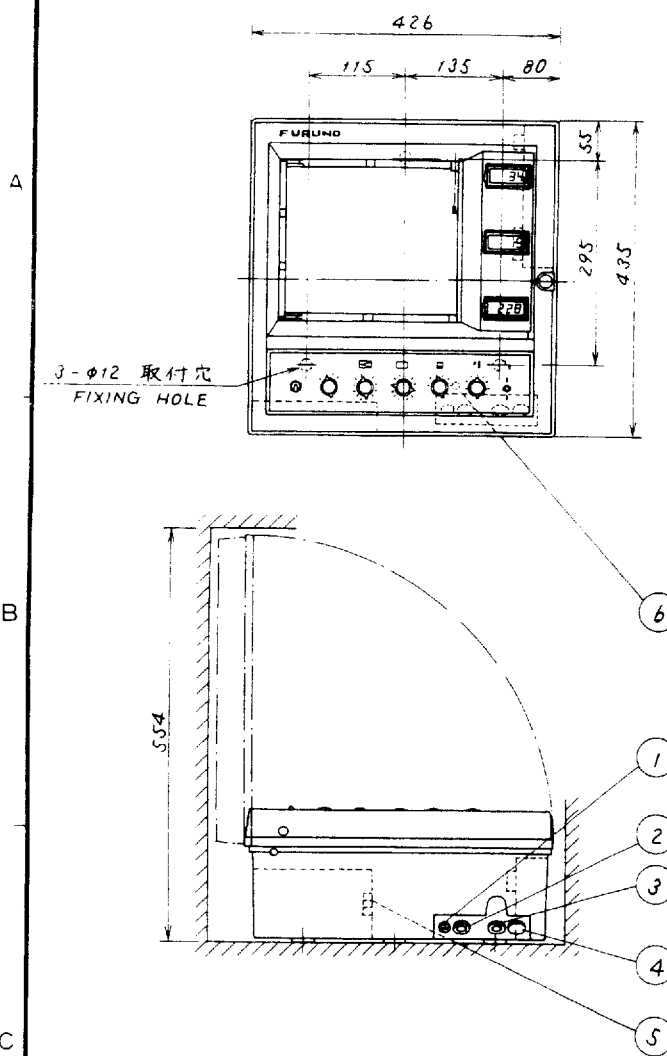

取付寸法
MOUNTING DIMENSION

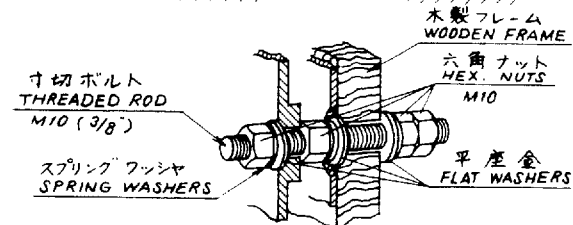
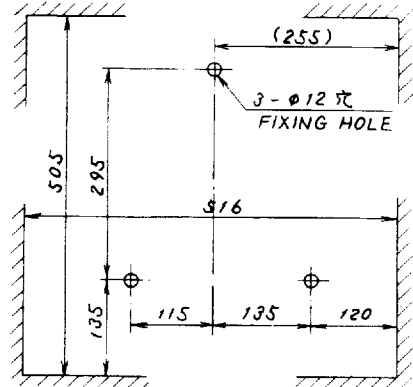

取付例
EXAMPLE OF MOUNTING

NOTE
1. コンパス安全距離
COMPASS SAFE DISTANCE

スタンダード STANDARD	80 cm
ステアリング STEERING	60 cm

品番 ITEM	品名 NAME	材質 MATERIAL	数量 QTY	図番 DWG. NO.	摘要 REMARKS
8	オプションターミナル OPTION TERMINAL		1		FOR FCV-110/111 /120/121
7	送受波器ターミナル TRANSDUCER TERMINAL		1		
6	アースターミナル GROUNDING TERMINAL		1		
5	電源ターミナル POWER SUPPLY TERMINAL		1		
4	ケーブル導入口(予備) CABLE INLET (SPARE)		1		
3	振動子ケーブル導入口 TRANSDUCER CABLE ENTRY		1		
2	電源ケーブル導入口 POWER CABLE ENTRY		1		
1	アース線引出レ口 GROUNDING WIRE ENTRY		1		

承認: *SEP. 1 1981*
 検 査:
 製 造:
 三 角 法 名 称: **FE-881 記録器**
 THIRD ANGLE PROJECTION TITLE: **FE-881II RECORDER**
 尺 度:
 SCALE:
 重 量: **17 kg**
 WEIGHT:
 図 番: **C2272-002-C**
 DWG. NO.

SPECIFICATIONS OF FE-881 MARK II

1. DEPTH RANGE

BASIC RANGE	PHASED RANGE						
5	0-5,	1-6,	2-7,	3-8	2094-2099	2095-2100
10	0-11,	1-11,	2-12,	3-13	2089-2099,	2090-2100
20	0-20,	1-21,	2-22,	3-13	2079-2099,	2080-2100
50	0-50,	1-51,	2-52,	3-53	2049-2099,	2050-2100
100	0-100,	1-101,	2-102,	3-103	1999-2099,	2000-2100
200	0-200,	1-201,	2-202,	3-203	1899-2099,	1900-2100
500	0-500,	1-501,	2-502,	3-503	1599-2099,	1600-2100

READOUT UNIT - Choice of meters, fathoms, brazas/passis, feet.

In feet, above figures are all 6-fold.

Maximum range is 2100m, 1100 fathoms, 1200 brazas/passis or 6600 feet.

2. BOTTOM-LOCK RANGE

2, 5, 10, 20 and 50 in meters, fathoms, brazas/passis, feet (in 6 fold).

Bottom-Lock Expansion registered on lower 1/4 or the paper width

3. MINIMUM MEASURABLE DEPTH

1m on 5/10/20/50m ranges with 50 or 200kHz transducer

4. ACCURACY

+1% Instrument accuracy for sound velocity 1500m/sec. Digital readout +1% or 1m, whichever is the greater.

5. DEPTH MARKER

Normal Range: 9 lines

Bottom-Lock Range: 4 lines

6. RECORDING PAPER

Dry Electrosensitive Paper PD-2020NW
204mmx20m (8"x61")

7. PAPER SPEED (mm/min)

BASIC RANGE	END OF RANGE								
	0		150m		300m		500m		2100m
	F	M	S	F	M	S	F/M	S	F/M/S
5, 10, 20, 50m	24	12	6	12	6	3	6	3	3
100m	12	6	3	12	6	3	6	3	3
200m				6	6	3	6	3	3
500m									3

In the stop position, recording belt stops but sea depth is digitally read out.

8. PULSE LENGTH

Basic range	Pulse Length (msec)
5, 10, 20m	0.3/0.6
50m	0.6/1.2
100m	1.2/1.8
200m	1.8/2.4
500m	2.4

9. SOUNDING RATE

Automatically changed with respect to the end of a selected depth range. (Ex. 400 pulses/minute to 36m on Basic Ranges 5, 10, 20m)

10. RECORDING RATE

Automatically changed with respect to the end of a selected depth range. (Ex. 200 times /minute to 50m on Basic Ranges 5, 10, 20, 50m)

11. FREQUENCY & TRANSDUCER

FREQ- UENCY	TRANS- DUCER	TRANSDUCER TANK			SIDE- BOARD INSTAL- LATION
		STEEL HULL	FRP HULL	WOODEN HULL	
15kHz	15F-4S	T-607	T-607-F	T-607-W	T-607-S
28kHz	28F-18*	T-612	T-612-F	T-612-W	T-2
	28F-8	T-604	T-604-F	T-604-W	T-514
50kHz	50B-6B*	T-605	T-605-F (T-246-F)	T-605-W (T-28)	T-27
	50B-9B	T-603	T-603-F	T-603-W (T-64)	T-63
	50B-12*	T-611	T-611-F	T-611-W	T-59
60kHz	60B-5S	T-605	T-605-F (T-246-F)	T-605-W (T-28)	T-27
	60B-52*	T-603	T-603-F	T-603-W (T-64)	T-63
88kHz	88B-8	T-606	T-606-F	T-606-W (T-222)	T-221
200kHz	200B-5S*	T-605	T-605-F (T-246-F)	T-605-W (T-28)	T-27
	200B-8B	T-608	T-608-F (T-245-F)	T-608-W (T-32B)	T-31

* Modification required in echo sounder

12. POWER SUPPLY

10-40VDC universal, 60W approx.
110/220VAC with external rectifier

13. OPTION

FCV-Series Color Sounder

Standard Spare Parts

<u>No.</u>	<u>Name</u>	<u>Type</u>	<u>Code No.</u>	<u>Q'ty</u>	<u>Remarks</u>
1	Fuse	FGB0 7A	000-549-013	2	For DC12V
2	Fuse	FGB0-A 5A	000-549-064	2	For DC24V
3	Fuse	FGB0-A 3A	000-549-063	2	For DC32V
4	Lamp	BA9SG10 (6V 2W)	000-540-018	2	
5	Recording Stylus	02-015-2190	002-015-219	2	
6	Sandpaper	AA600 30x150mm	000-835-651	1	
7	Recording Paper	PD-2020NW	000-878-457	2	
8	Socket Screw Wrench	1.5mm	000-830-120	1	

Installation Materials

<u>No.</u>	<u>Name</u>	<u>Type</u>	<u>Code No.</u>	<u>Q'ty</u>
1	Cable	VCT3.5x2C 2.5m	000-564-241	1
2	Crimp-on Lug	FV-S3.3	000-538-110	3
3	Vinyl Sheath Wire	VSF-2.0sq, black	000-550-501	2m

ECHOSOUNDER FE-881II INSTALLATION INSTRUCTIONS

SELECTION OF INSTALLATION SITE

RECORDER UNIT

- Select a well ventilated place not exposed to direct sunshine and water splash.
- Select a place sufficiently apart from noise generating equipment, radio equipment and its antenna feeder.
- Select a place convenient for operation, maintenance and future service.

TRANSDUCER

The performance of the echosounder greatly depends on the selection of transducer position. The following points should be taken into account:

- Select a place not affected by air bubbles.
Generally, they are at minimum at the place where the first bow wave falls and the next wave rises at normal ship's speed. In small ships, midship position is usually a good place.
- Select a place on or near the keel line; the nearer is better to minimize the affection of air bubbles.
- To reduce the affection of aerated water, a projection of 250mm or around is required for the transducer but it should not exceed the keel line.
- Select a place as far from engine, generator, motor or other electric equipments as possible.

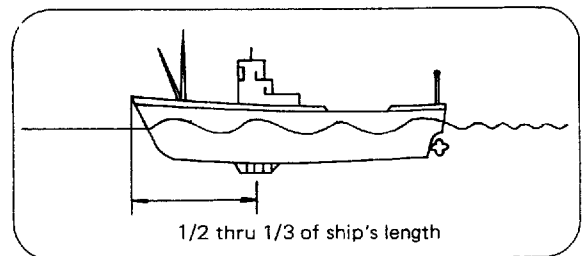

TRANSDUCER INSTALLATION

THRU-HULL PIPE

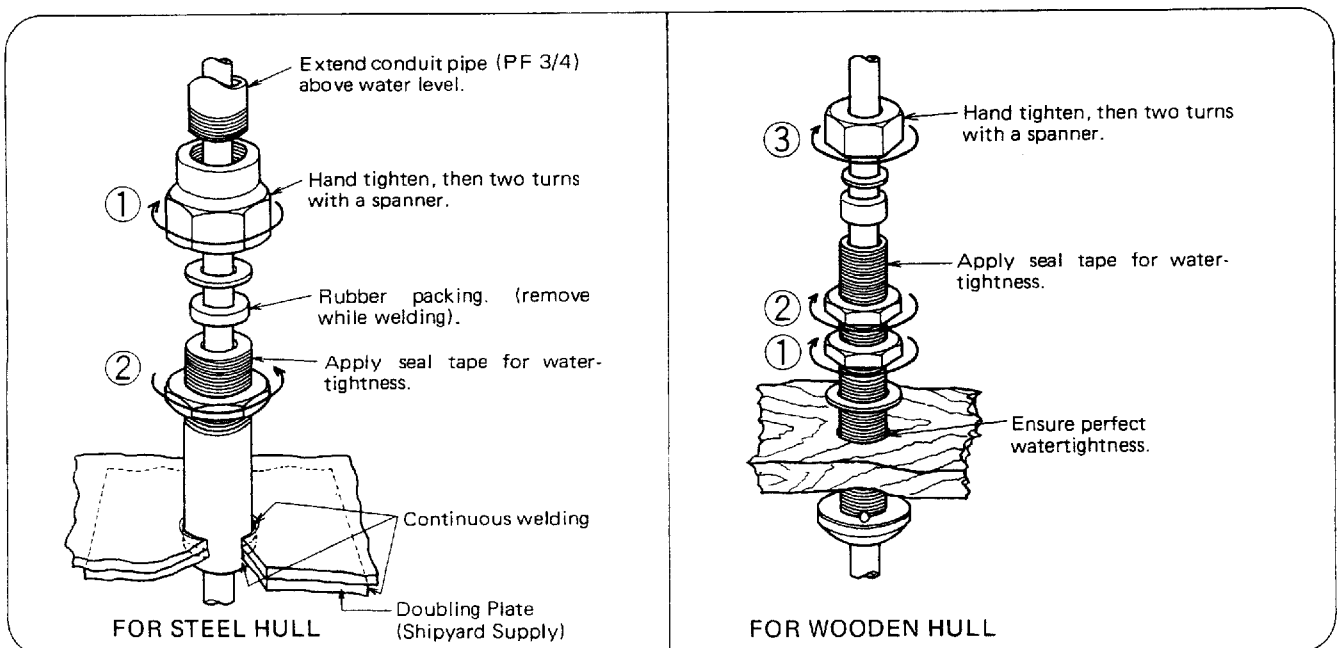

TRANSDUCER TANK

Examples of installation for 50kHz, 60kHz and 200kHz transducers are shown below. Similar ways can be employed for other frequencies.

STEEL HULL INSTALLATION

TRANSDUCER: 50B-6B, 60B-5S, 200B-5S

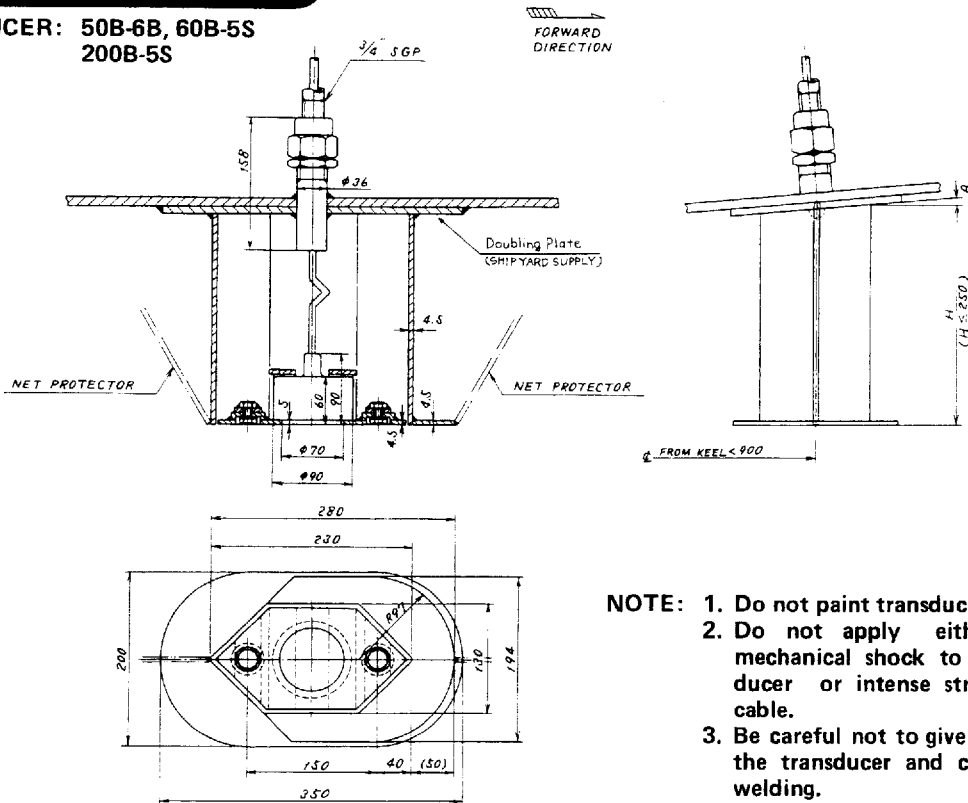

- NOTE:**
1. Do not paint transducer face.
 2. Do not apply either strong mechanical shock to the transducer or intense stress to the cable.
 3. Be careful not to give damage to the transducer and cable while welding.

WOODEN HULL INSTALLATION

TRANSDUCER: 50B-6B, 60B-5S, 200B-5S

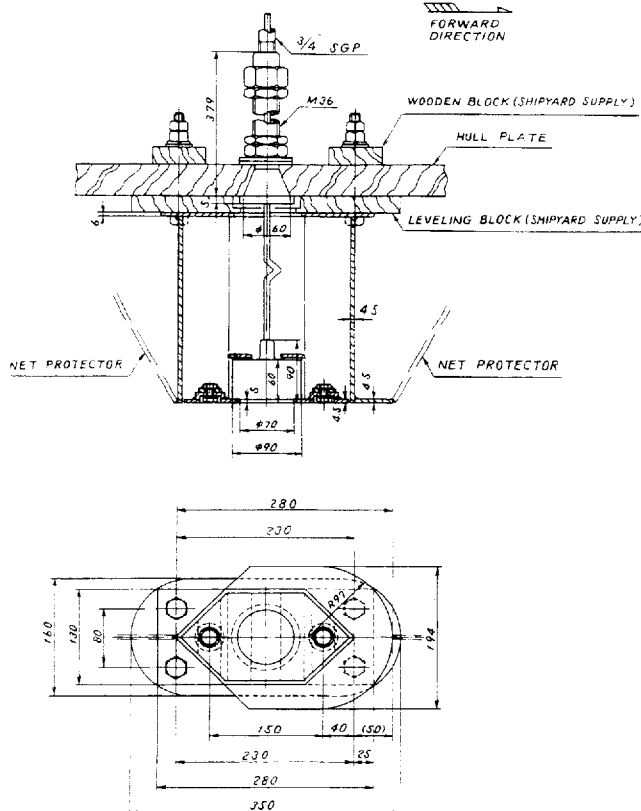

FRP HULL INSTALLATION

TRANSDUCER: 50B-6B, 60B-5S, 200B-5S

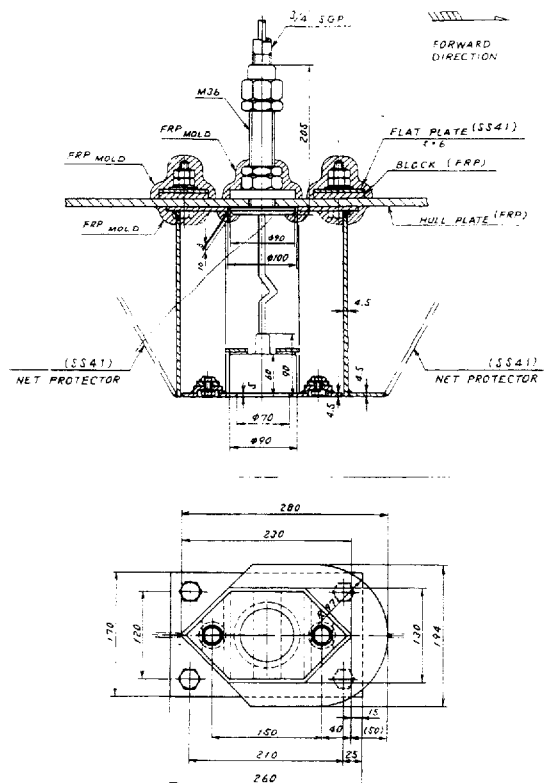

SIDEBOARD INSTALLATION

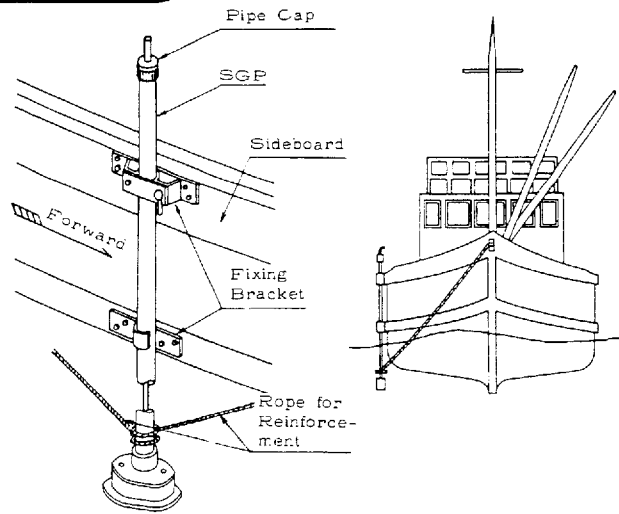

RECORDER UNIT

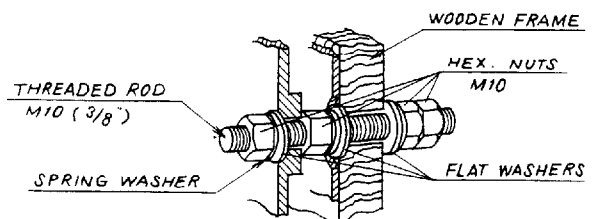
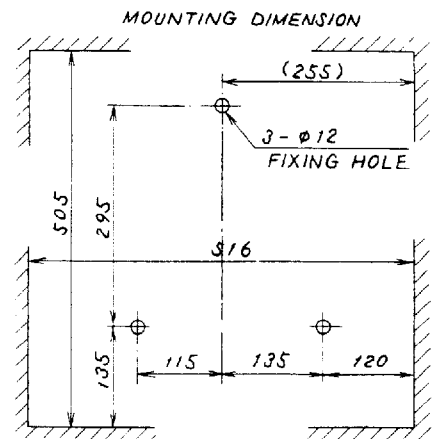
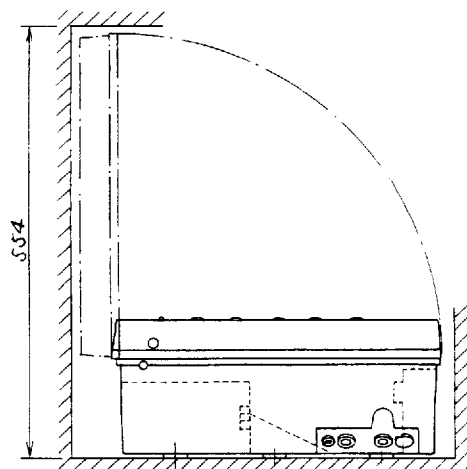
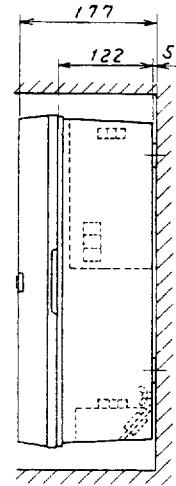
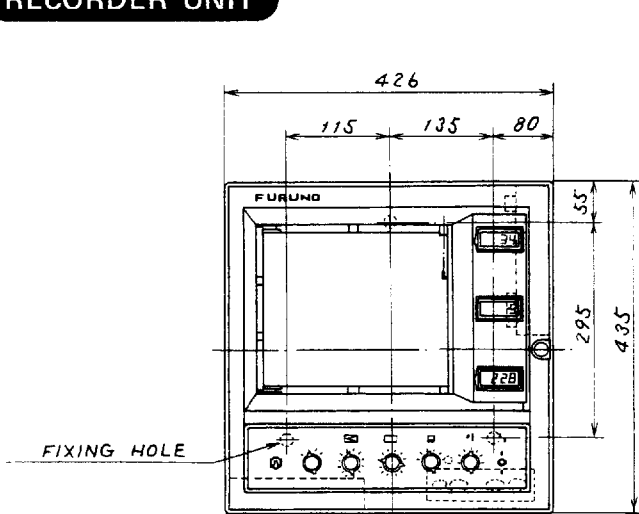

EXAMPLE OF MOUNTING

RECTIFIER UNIT

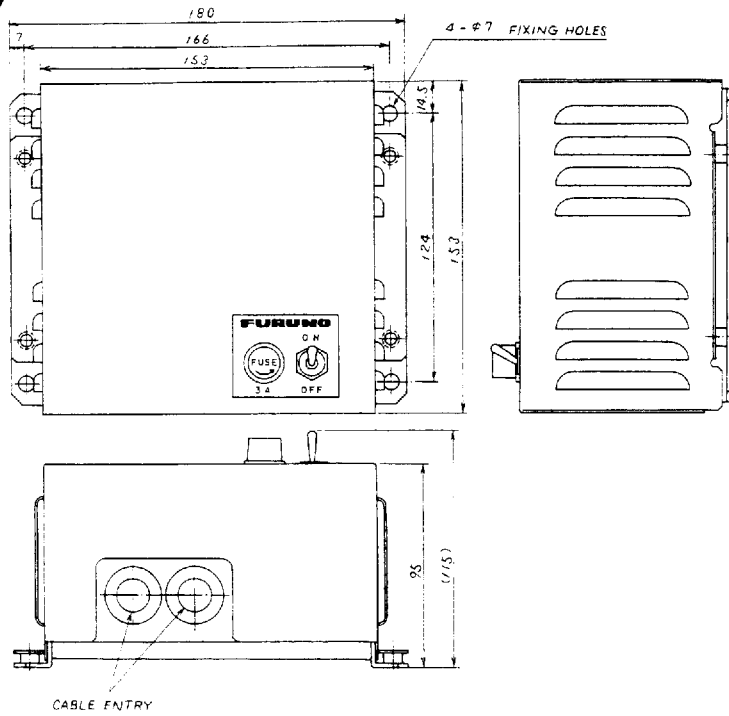

INTERCONNECTION DIAGRAM

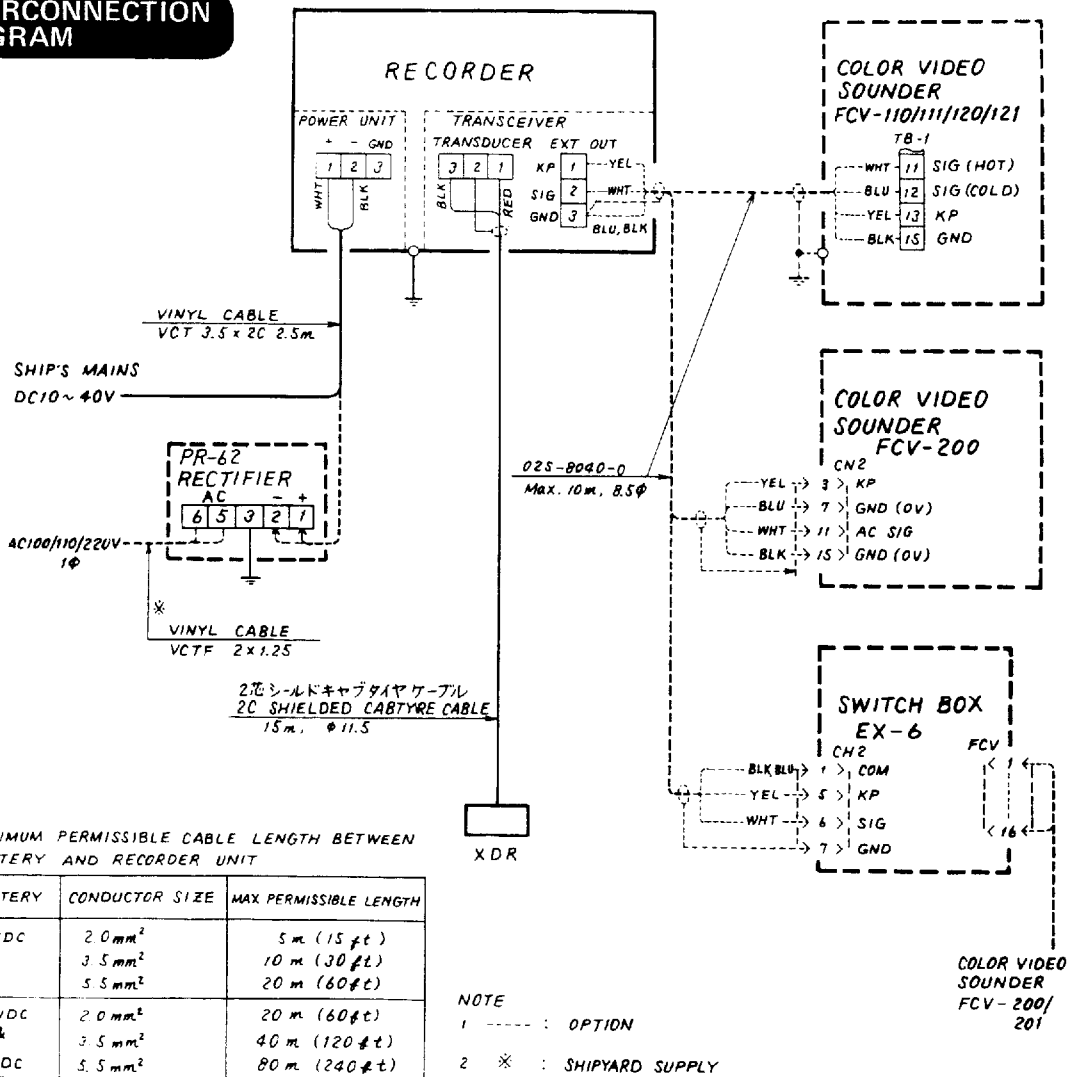

WIRING & CONNECTION

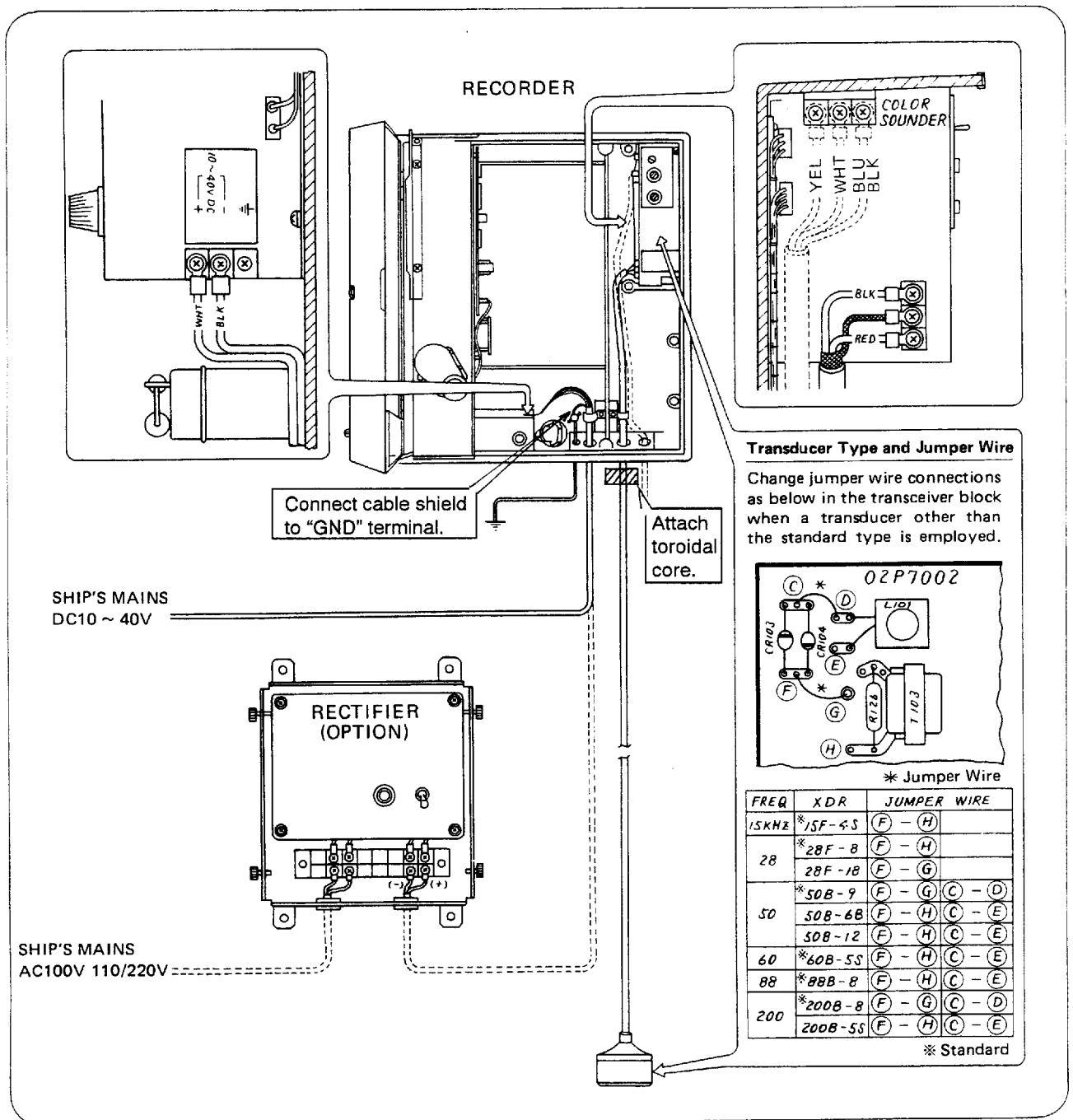

SHIP'S MAINS VOLTAGE CHECK

The FE-881II normally requires 4.5A on 12VDC, 2.3A on 24VDC, or 1.8A on 32VDC. However, it draws a rush current about 8.2A on 12VDC, 6.5A on 24VDC, or 6A on 32VDC operation when the recorder is turned on or the Basic Range is changed to 5, 10, 20 or 50m.

As the power supply cable has a certain amount of resistance between the battery and recorder, the surge current may cause the recorder input voltage to drop beyond the tolerance of the recorder operation. The recorder is designed to operate on 10-40VDC across input terminals 1 and 2. Please check input voltage when the POWER switch is turned on or the Basic Range changed.

It is recommended to use a heavier cable for a longer cable run. The list in the interconnection diagram gives the guideline for maximum permissible cable run with respect to the cable size.

PRESET SWITCH SETTING

Miniature switches located inside the recorder are provided for alteration of pulse length and bottom contour line width, testing and self-checking of the equipment, etc.

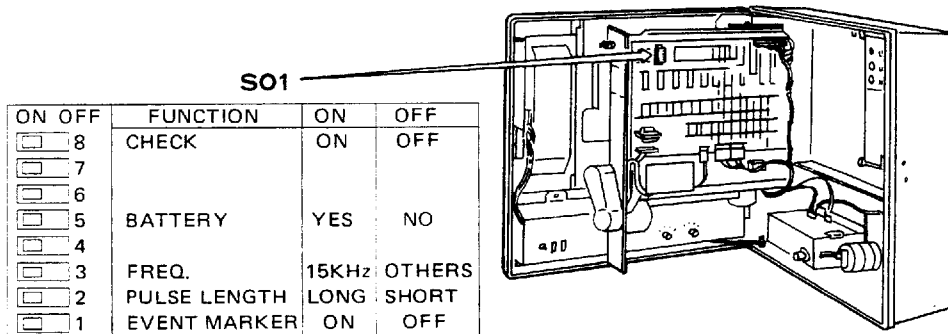

1. EVENT MARKER (Test marker for checking stylus contact and recording uniformity)

OFF: Normal operation

ON : Marker line is drawn with the highest intensity. Improper stylus contact causes irregular density of marker.

2. PULSE LENGTH

OFF: Short (Standard)

ON : Long

BASIC RANGE	OFF	ON
5, 10, 20m	*0.3ms.	0.6ms
50	0.6	1.2
100	1.2	1.8
200	1.8	2.4
500	2.4	2.4

* 0.6ms for
15 kHz
System

3. FREQUENCY

OFF: Other than 15 kHz

ON : 15kHz

4. 6 & 7. Not applied.

5. BATTERY (On-off switch for memory back-up)

OFF: No (Battery isolated)

ON : Yes (Battery connected for memory back-up)

Note: 1. With the battery voltage of 3.5V or above, the phased range and the record start point data are stored until next power-on.

2. Beware of low battery voltage due to self-discharging when the echosounder is not powered for extended period of time.

8. CHECK (Diagnostic self-check for troubleshooting)

OFF: Normal operation

ON : Following checks are carried out:

1 The TEST PATTERN is drawn with 8 steps of density graduation.

2 Results of RAM and ROM check are displayed on the PHASE indicator.

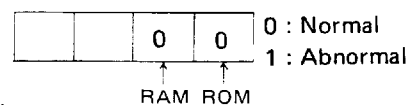

3 The numbers from 0 thru 9 are sequentially displayed in ascending order at 4 seconds interval on all LCD indicators.

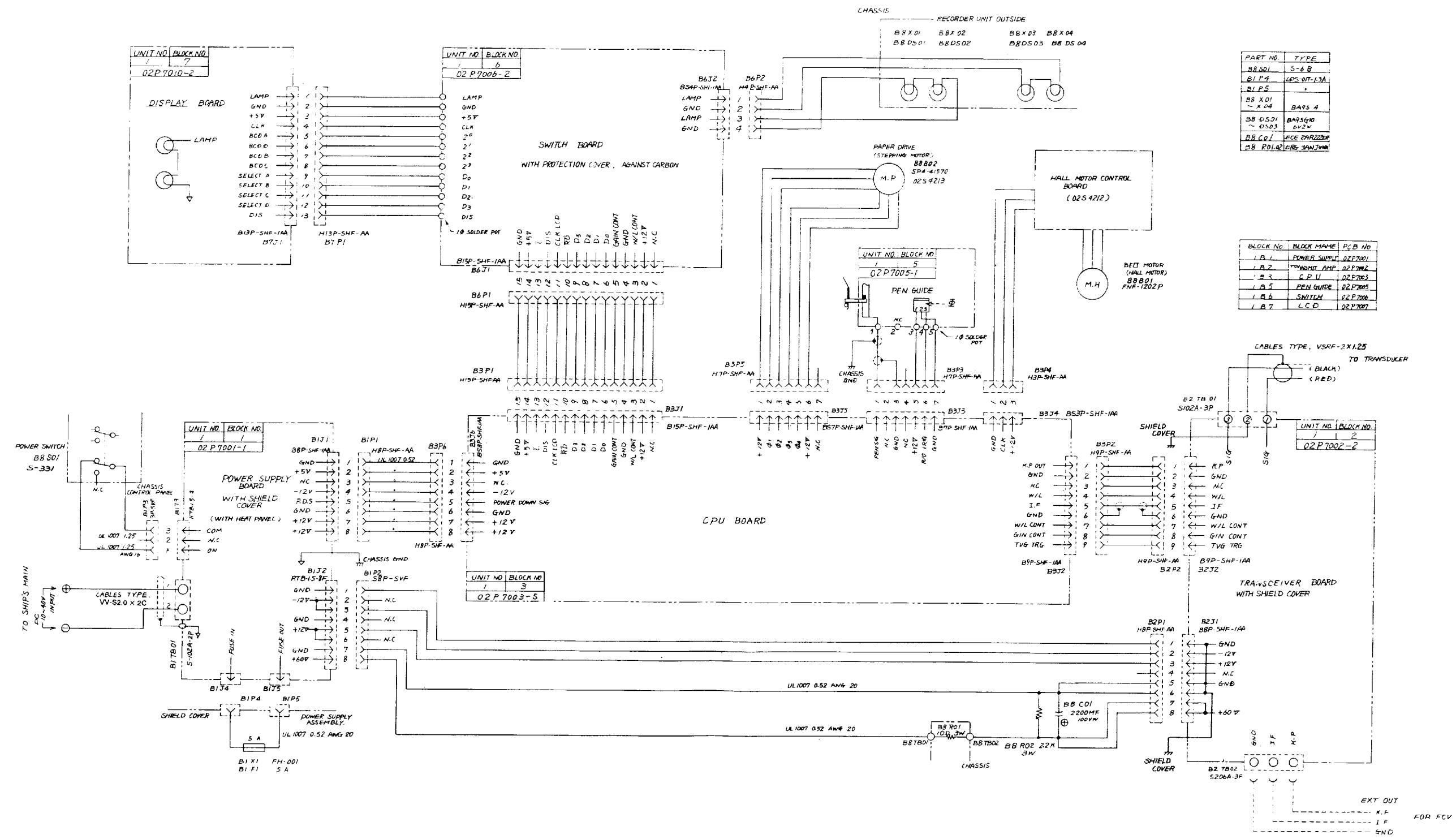

PART NO.	TYPE
B8 501	S-6 B
B1 P4	LED-01-13A
B1 P5	
B8 X01	BA9S 4
B8 X04	BA9S 4
B8 D5J1	BA9S40
B8 D5J3	6x2W
B8 C01	KCE 2PR220
B8 R01	ERE 30ANT

BLOCK NO.	BLOCK NAME	P.C.B. NO.
B 1	POWER SUPPLY	02P7001
B 2	POWER SUPPLY	02P7002
B 3	C.P.U.	02P7003
B 4	PEN GUIDE	02P7004
B 5	SWITCH	02P7005
B 6	L.C.D.	02P7006

CABLES TYPE, VSXF-2X125
 (BLACK)
 (RED)
 TO TRANSDUCER

UNIT NO.	BLOCK NO.
1	2

UNIT NO.	BLOCK NO.
1	2

承認	品名	材料	数量	圖番	摘要	
APPROVED	ITEM	NAME	MATERIAL	QTY	DWG. NO.	REMARKS
承認 2002.02.13 検 2002.02.13 製 2002.02.13	品名 三角法 尺 重量	材料 数量 圖番 DWG. NO.	数量 QTY	圖番 DWG. NO.	摘要 名称 FE-881 総合回路図 FE-881II SCHEMATIC DIAGRAM C2272-005-C	