

# DENON

## STEREO CASSETTE TAPE DECK

# DN-780R

OPERATING INSTRUCTIONS  
BEDIENUNGSANLEITUNG  
MODE D'EMPLOI  
ISTRUZIONI PER L'USO

INSTRUCCIONES DE OPERACION  
GEBRUIKSAANWIJZING  
BRUKSANVISNING

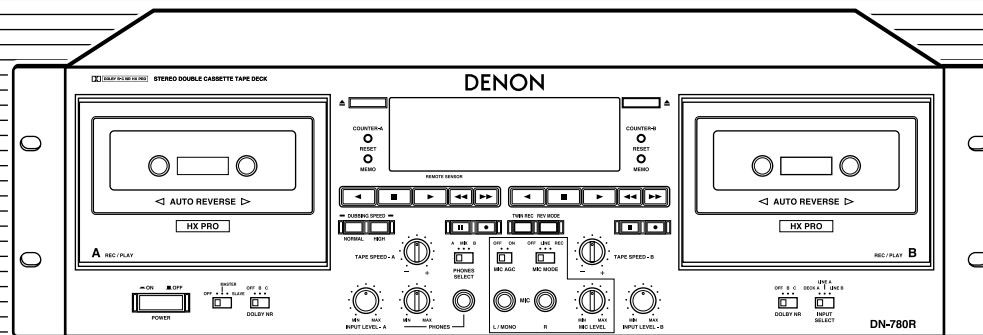

FOR ENGLISH READERS	PAGE	5	~	PAGE	13
FÜR DEUTSCHE LESER	SEITE	14	~	SEITE	22
POUR LES LECTEURS FRANCAIS	PAGE	23	~	PAGE	31
PER IL LETTORE ITALIANO	PAGINA	32	~	PAGINA	40
PARA LECTORES DE ESPAÑOL	PAGINA	41	~	PAGINA	49
VOOR NEDERLANDSTALIGE LEZERS	PAGINA	50	~	PAGINA	58
FOR SVENSKA LÄSARE	SIDA	59	~	SIDA	67



**CAUTION**  
**RISK OF ELECTRIC SHOCK**  
**DO NOT OPEN**



**CAUTION: TO REDUCE THE RISK OF ELECTRIC SHOCK, DO NOT REMOVE COVER (OR BACK). NO USER SERVICEABLE PARTS INSIDE. REFER SERVICING TO QUALIFIED SERVICE PERSONNEL.**



The lightning flash with arrowhead symbol, within an equilateral triangle, is intended to alert the user to the presence of uninsulated "dangerous voltage" within the product's enclosure that may be of sufficient magnitude to constitute a risk of electric shock to persons.



The exclamation point within an equilateral triangle is intended to alert the user to the presence of important operating and maintenance (servicing) instructions in the literature accompanying the appliance.

**WARNING: TO PREVENT FIRE OR SHOCK HAZARD, DO NOT EXPOSE THIS APPLIANCE TO RAIN OR MOISTURE.**

**CAUTION:**

**1. Handle the power supply cord carefully**

Do not damage or deform the power supply cord. If it is damaged or deformed, it may cause electric shock or malfunction when used. When removing from wall outlet, be sure to remove by holding the plug attachment and not by pulling the cord.

**2. Do not open the top cover**

In order to prevent electric shock, do not open the top cover. If problems occur, contact your DENON dealer.

**3. Do not place anything inside**

Do not place metal objects or spill liquid inside the cassette tape deck. Electric shock or malfunction may result.

Please, record and retain the Model name and serial number of your set shown on the rating label.

Model No. DN-780R Serial No. \_\_\_\_\_

This device complies with Part 15 of the FCC Rules. Operation is subject to the following two conditions : (1) This device may not cause harmful interference, and (2) this device must accept any interference received, including interference that may cause undesired operation.

This Class B digital apparatus meets all requirements of the Canadian Interference-Causing Equipment Regulations.

Cet appareil numérique de la classe B respecte toutes les exigences du Règlement sur le matériel brouilleur du Canada.

**SAFETY INSTRUCTIONS**

- Read Instructions – All the safety and operating instructions should be read before the product is operated.
- Retain Instructions – The safety and operating instructions should be retained for future reference.
- Heed Warnings – All warnings on the product and in the operating instructions should be adhered to.
- Follow Instructions – All operating and use instructions should be followed.
- Cleaning – Unplug this product from the wall outlet before cleaning. Do not use liquid cleaners or aerosol cleaners.
- Attachments – Do not use attachments not recommended by the product manufacturer as they may cause hazards.
- Water and Moisture – Do not use this product near water – for example, near a bath tub, wash bowl, kitchen sink, or laundry tub; in a wet basement; or near a swimming pool; and the like.
- Accessories – Do not place this product on an unstable cart, stand, tripod, bracket, or table. The product may fall, causing serious injury to a child or adult, and serious damage to the product. Use only with a cart, stand, tripod, bracket, or table recommended by the manufacturer, or sold with the product. Any mounting of the product should follow the manufacturer's instructions, and should use a mounting accessory recommended by the manufacturer.
- A product and cart combination should be moved with care. Quick stops, excessive force, and uneven surfaces may cause the product and cart combination to overturn.
- Ventilation – Slots and openings in the cabinet are provided for ventilation and to ensure reliable operation of the product and to protect it from overheating, and these openings must not be blocked or covered. The openings should never be blocked by placing the product on a bed, sofa, rug, or other similar surface. This product should not be placed in a built-in installation such as a bookcase or rack unless proper ventilation is provided or the manufacturer's instructions have been adhered to.
- Power Sources – This product should be operated only from the type of power source indicated on the marking label. If you are not sure of the type of power supply to your home, consult your product dealer or local power company. For products intended to operate from battery power, or other sources, refer to the operating instructions.
- Grounding or Polarization – This product may be equipped with a polarized alternating-current line plug (a plug having one blade wider than the other). This plug will fit into the power outlet only one way. This is a safety feature. If you are unable to insert the plug fully into the outlet, try reversing the plug. If the plug should still fail to fit, contact your electrician to replace your obsolete outlet. Do not defeat the safety purpose of the polarized plug.
- Power-Cord Protection – Power-supply cords should be routed so that they are not likely to be walked on or pinched by items placed upon or against them, paying particular attention to cords at plugs, convenience receptacles, and the point where they exit from the product.
- Outdoor Antenna Grounding – If an outside antenna or cable system is connected to the product, be sure the antenna or cable system is grounded so as to provide some protection against voltage surges and built-up static charges. Article 810 of the National Electrical Code, ANSI/NFPA 70, provides information with regard to proper grounding of the mast and supporting structure, grounding of the lead-in wire to an antenna discharge unit, size of grounding conductors, location of antenna-discharge unit, connection to grounding electrodes, and requirements for the grounding electrode. See Figure A.
- Lightning – For added protection for this product during a lightning storm, or when it is left unattended and unused for long periods of time, unplug it from the wall outlet and disconnect the antenna or cable system. This will prevent damage to the product due to lightning and power-line surges.
- Power Lines – An outside antenna system should not be located in the vicinity of overhead power lines or other electric light or power circuits, or where it can fall into such power lines or circuits. When installing an outside antenna system, extreme care should be taken to keep from touching such power lines or circuits as contact with them might be fatal.
- Overloading – Do not overload wall outlets, extension cords, or integral convenience receptacles as this can result in a risk of fire or electric shock.
- Object and Liquid Entry – Never push objects of any kind into this product through openings as they may touch dangerous voltage points or short-out parts that could result in a fire or electric shock. Never spill liquid of any kind on the product.
- Servicing – Do not attempt to service this product yourself as opening or removing covers may expose you to dangerous voltage or other hazards. Refer all servicing to qualified service personnel.
- Damage Requiring Service – Unplug this product from the wall outlet and refer servicing to qualified service personnel under the following conditions:
  - When the power-supply cord or plug is damaged,
  - If liquid has been spilled, or objects have fallen into the product,
  - If the product has been exposed to rain or water,
  - If the product does not operate normally by following the operating instructions. Adjust only those controls that are covered by the operating instructions as an improper adjustment of other controls may result in damage and will often require extensive work by a qualified technician to restore the product to its normal operation,
  - If the product has been dropped or damaged in any way, and
  - When the product exhibits a distinct change in performance – this indicates a need for service.
- Replacement Parts – When replacement parts are required, be sure the service technician has used replacement parts specified by the manufacturer or have the same characteristics as the original part. Unauthorized substitutions may result in fire, electric shock, or other hazards.
- Safety Check – Upon completion of any service or repairs to this product, ask the service technician to perform safety checks to determine that the product is in proper operating condition.
- Wall or Ceiling Mounting – The product should be mounted to a wall or ceiling only as recommended by the manufacturer.
- Heat – The product should be situated away from heat sources such as radiators, heat registers, stoves, or other products (including amplifiers) that produce heat.

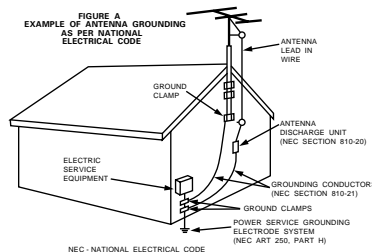

FRONT PANEL  
FRONTPLATTE  
PANNEAU AVANT  
PANNELLO FRONTALE  
PANEL DELANTERO  
VOORPANEEL  
FRONT PANELEN

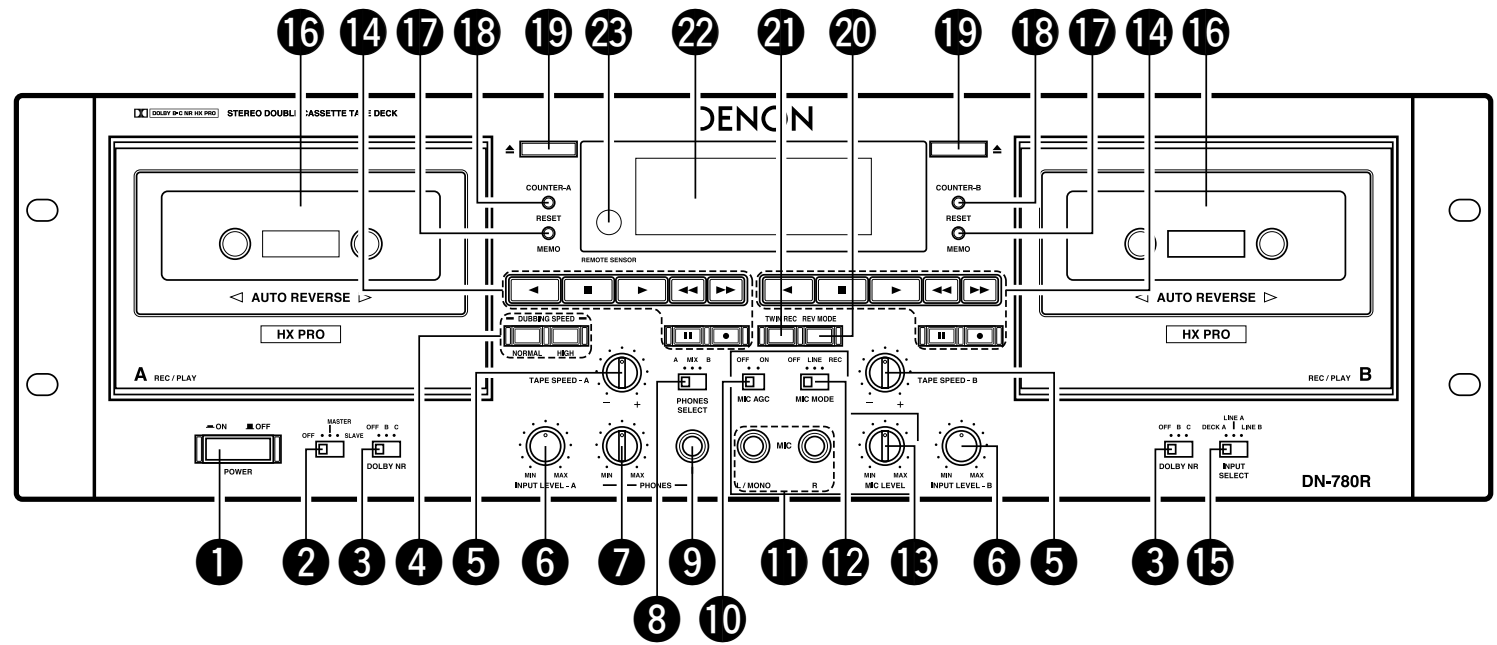

REAR PANEL  
RÜCKWAND  
PANNEAU ARRIERE  
IL PANNELLO POSTERIORE  
PANEL TRASERO  
ACHTERPANEEL  
BAKSIDAN

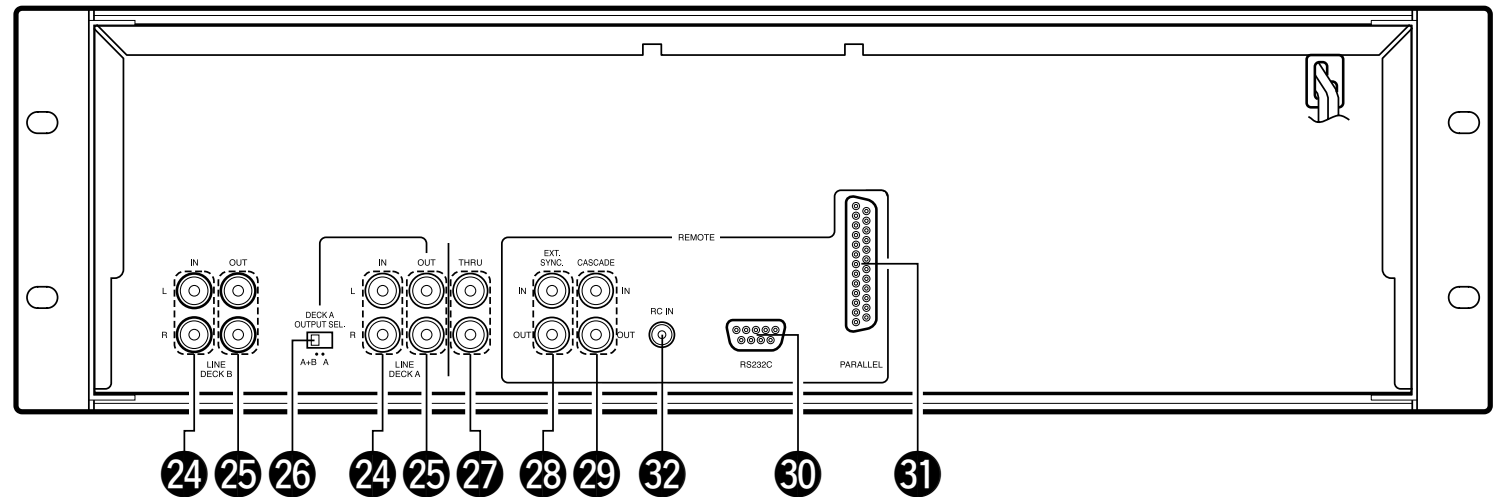

**NOTE ON USE / HINWEISE ZUM GEBRAUCH /  
OBSERVATIONS RELATIVES A L'UTILISATION / NOTE SULL'USO  
NOTAS SOBRE EL USO / ALVORENS TE GEBRUIKEN / OBSERVERA**

**• DECLARATION OF CONFORMITY**

We declare under our sole responsibility that this product, to which this declaration relates, is in conformity with the following standards:

EN60065, EN55013, EN55020, EN61000-3-2 and EN61000-3-3.

Following the provisions of 73/23/EEC, 89/336/EEC and 93/68/EEC Directive.

**• ÜBEREINSTIMMUNGSERKLÄRUNG**

Wir erklären unter unserer Verantwortung, daß dieses Produkt, auf das sich diese Erklärung bezieht, den folgenden Standards entspricht:

EN60065, EN55013, EN55020, EN61000-3-2 und EN61000-3-3.

Entspricht den Verordnungen der Direktive 73/23/EEC, 89/336/EEC und 93/68/EEC.

**• DECLARATION DE CONFORMITE**

Nous déclarons sous notre seule responsabilité que l'appareil, auquel se réfère cette déclaration, est conforme aux standards suivants:

EN60065, EN55013, EN55020, EN61000-3-2 et EN61000-3-3.

D'après les dispositions de la Directive 73/23/EEC, 89/336/EEC et 93/68/EEC.

**• DICHIARAZIONE DI CONFORMITÀ**

Dichiariamo con piena responsabilità che questo prodotto, al quale la nostra dichiarazione si riferisce, è conforme alle seguenti normative:

EN60065, EN55013, EN55020, EN61000-3-2 e EN61000-3-3.

In conformità con le condizioni delle direttive 73/23/EEC, 89/336/EEC e 93/68/EEC.

QUESTO PRODOTTO E' CONFORME  
AL D.M. 28/08/95 N. 548

**• DECLARACIÓN DE CONFORMIDAD**

Declaramos bajo nuestra exclusiva responsabilidad que este producto al que hace referencia esta declaración, está conforme con los siguientes estándares:

EN60065, EN55013, EN55020, EN61000-3-2 y EN61000-3-3.

Siguiendo las provisiones de las Directivas 73/23/EEC, 89/336/EEC y 93/68/EEC.

**• EENVORMIGHEIDSVERKLARING**

Wij verklaren uitsluitend op onze verantwoordelijkheid dat dit product, waarop deze verklaring betrekking heeft, in overeenstemming is met de volgende normen:

EN60065, EN55013, EN55020, EN61000-3-2 en EN61000-3-3.

Volgens de bepalingen van de Richtlijnen 73/23/EEC, 89/336/EEC en 93/68/EEC.

**• ÖVERENSSTÄMMELSESINTYG**

Härmed intygas helt på eget ansvar att denna produkt, vilken detta intyg avser, uppfyller följande standarder:

EN60065, EN55013, EN55020, EN61000-3-2 och EN61000-3-3.

Enligt stadgarna i direktiv 73/23/EEC, 89/336/EEC och 93/68/EEC.

**CAUTION**

- The ventilation should not be impeded by covering the ventilation openings with items, such as newspapers, table-cloths, curtains, etc.
- No naked flame sources, such as lighted candles, should be placed on the apparatus.
- Please be care the environmental aspects of battery disposal.
- The apparatus shall not be exposed to dripping or splashing for use.
- No objects filled with liquids, such as vases, shall be placed on the apparatus.

**• FOR CANADA MODEL ONLY**

**CAUTION**

TO PREVENT ELECTRIC SHOCK, MATCH WIDE BLADE OF PLUG TO WIDE SLOT, FULLY INSERT.

**• POUR LES MODELE CANADIENS  
UNIQUEMENT**

**ATTENTION**

POUR ÉVITER LES CHOCS ÉLECTRIQUES, INTEROUIRE LA LAME LA PLUS LARGE DE LA FICHE DANS LA BORNE CORRESPONDANTE DE LA PRISE ET POUSSER JUSQU' AU FOND.

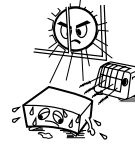

- Avoid high temperatures. Allow for sufficient heat dispersion when installed on a rack.
- Vermeiden Sie hohe Temperaturen. Beachten Sie, daß eine ausreichend Luftzirkulation gewährleistet wird, wenn das Gerät auf ein Regal gestellt wird.
- Eviter des températures élevées. Tenir compte d'une dispersion de chaleur suffisante lors de l'installation sur une étagère.
- Evitate de esporre l'unità a temperature alte. Assicuratevi che ci sia un'adeguata dispersione del calore quando installate l'unità in un mobile per componenti audio.
- Evite altas temperaturas. Permite la suficiente dispersión del calor cuando está instalado en la consola.
- Vermijd hoge temperaturen. Zorg voor een degelijk hitteafvoer indien het apparaat op een rek wordt geplaatst.
- Undvik höga temperaturer. Se till att det finns möjlighet till god värmeavledning vid montering i ett rack.



- Keep the set free from moisture, water, and dust.
- Halten Sie das Gerät von Feuchtigkeit, Wasser und Staub fern.
- Protéger l'appareil contre l'humidité, l'eau et l'apousière.
- Tenete l'unità lontana dall'umidità, dall'acqua e dalla polvere.
- Mantenga el equipo libre de humedad, agua y polvo.
- Laat geen vochtigheid, water of stof in het apparaat binnendringen.
- Utsätt inte apparaten för fukt, vatten och damm.



- Do not let foreign objects in the set.
- Keine fremden Gegenstände in das Gerät kommen lassen.
- Ne pas laisser des objets étrangers dans l'appareil.
- E' importante che nessun oggetto è inserito all'interno dell'unità.
- No deje objetos extraños dentro del equipo.
- Laat geen vreemde voorwerpen in dit apparaat vallen.
- Se till att främmande föremål inte tränger in i apparaten.



- Unplug the power cord when not using the set for long periods of time.
- Wenn das Gerät eine längere Zeit nicht verwendet werden soll, trennen Sie das Netzkabel vom Netzstecker.
- Débrancher le cordon d'alimentation lorsque l'appareil n'est pas utilisé pendant de longues périodes.
- Disinnestate il filo di alimentazione quando avete l'intenzione di non usare il filo di alimentazione per un lungo periodo di tempo.
- Desconecte el cordón de energía cuando no utilice el equipo por mucho tiempo.
- Neem altijd het netsnoer uit het stopcontact wanneer het apparaat gedurende een lange periode niet wordt gebruikt.
- Koppla ur nätkabeln om apparaten inte kommer att användas i lång tid.



- Do not let insecticides, benzene, and thinner come in contact with the set.
- Lassen Sie das Gerät nicht mit Insektiziden, Benzin oder Verdünnungsmitteln in Berührung kommen.
- Ne pas mettre en contact des insecticides, du benzène et un diluant avec l'appareil.
- Assicuratevi che l'unità non venga in contatto con insetticidi, benzolo o solventi.
- No permita el contacto de insecticidas, gasolina y diluyentes con el equipo.
- Laat geen insektenverdelgende middelen, benzine of verfvredunder met dit apparaat in contact komen.
- Se till att inte insektsmedel på spraybruk, bensen och thinner kommer i kontakt med apparatens hölje.



- Handle the power cord carefully. Hold the plug when unplugging the cord.
- Gehen Sie vorsichtig mit dem Netzkabel um. Halten Sie das Kabel am Stecker, wenn Sie den Stecker herausziehen.
- Manipuler le cordon d'alimentation avec précaution. Tenir la prise lors du débranchement du cordon.
- Maneggiare il filo di alimentazione con cura. Agite per la spina quando scollegate il cavo dalla presa.
- Maneje el cordón de energía con cuidado. Sostenga el enchufe cuando desconecte el cordón de energía.
- Hanteer het netsnoer voorzichtig. Houd het snoer bij de stekker vast wanneer deze moet worden aan- of losgekoppeld.
- Hantera nätkabeln varsamt. Håll i kabeln när den kopplas från el-uttaget.



- \* (For sets with ventilation holes)
- Do not obstruct the ventilation holes.
- Die Belüftungsöffnungen dürfen nicht verdeckt werden.
- Ne pas obstruer les trous d'aération.
- Non coprite i fori di ventilazione.
- No obstruya los orificios de ventilación.
- De ventilatieopeningen mogen niet worden geblokkeerd.
- Täpp inte till ventilationsöppningarna.



- Never disassemble or modify the set in any way.
- Versuchen Sie niemals das Gerät auseinander zu nehmen oder auf jegliche Art zu verändern.
- Ne jamais démonter ou modifier l'appareil d'une manière ou d'une autre.
- Non smontate mai, né modificate l'unità in nessun modo.
- Nunca desarme o modifique el equipo de ninguna manera.
- Nooit dit apparaat demonteren of op andere wijze modifieren.
- Ta inte isär apparaten och försök inte bygga om den.

Thank you very much for purchasing the DENON component stereo cassette tape deck. DENON proudly presents this advanced tape deck to audiophiles and music lovers as a further proof of DENON's non-compromising pursuit of the ultimate in sound quality. The high quality performance and easy operation are certain to provide you with many hours of outstanding listening pleasure.

— TABLE OF CONTENTS —

FEATURES .....5  
 NAMES AND FUNCTIONS OF PARTS .....5 ~ 7  
 CASSETTE TAPES.....8  
 AUTOMATIC TAPE SELECTION.....8  
 PLAYBACK.....8, 9  
   RELAY PLAY .....8  
   TWIN OUTPUT .....8  
   MUSIC SEARCH SYSTEM .....8  
   POWER ON PLAYBACK .....9  
 RECORDING .....9, 10  
   PROPER RECORDING LEVEL .....9  
   REC/REC MUTE AND REC PAUSE BUTTON ...9  
   AUTO-STANDBY .....10  
   TWIN RECORDING .....10  
   RELAY RECORDING .....10  
   SYNCHRONIZED OPERATION .....10  
 DUBBING.....11  
   MANUAL DUBBING .....11  
 MEMORY STOP .....11  
 PRESET FUNCTION .....11  
 DOLBY B AND C NOISE REDUCTION SYSTEM ...12  
 DOLBY HX-PRO HEADROOM .....12  
 EXTENSION SYSTEM .....12  
 MAINTENANCE .....12  
 TROUBLESHOOTING .....13  
 SPECIFICATIONS .....13

Please check to make sure the following items are included with the main unit in the carton:

- (1) Operating Instructions.....1
- (2) Operating Instructions (Applications) .....1
- (3) Connection Cords.....4
- (4) Service Station List .....1

FEATURES

- 19-inch Rack Mountable
- Independent Input/Output
- Dolby B & C Noise Reduction Systems (A/B Independent)
- Dolby HX-Pro Headroom Extension System
- Twin Recording and Relay Recording
- Relay Playback
- TS MIC Jacks on Front Panel
- Cascade Recording and Playback
- Synchronized Recording
- RS232C Serial Control Port
- Parallel Remote Control
- 2-Speed Dubbing
- Quick Auto Reverse
- Speed Control of Approximately ±12% (A/B Independent)
- Computer Controlled Mechanism
- Computing Tape Counter with 4-Digit Readout and Memory Stop
- Music Search System
- FL Peak Level Meters
- Auto Tape Selector
- Memory Back-up
- Auto-standby
- XLR Input/Output Kit (Option) (Model Name :ACD-780)

NAMES AND FUNCTIONS OF PARTS

- 1 Power Operation Switch (POWER)**  
 Press once to turn the power on, and once more to turn the power off.  
 The deck remains in a stand-by (non-operative) mode for approximately 2 seconds after it is switched on.
- 2 Master/Slave Switch**  
 For normal operation, set this to "OFF".  
 Set the switch to "MASTER" or "SLAVE" when using the DN-780R together with other DN-780Rs.
- 3 Dolby NR Switch (DOLBY NR)**  
 Select the Dolby NR type that suits the recording.  
  
 OFF : Recording without Dolby NR  
 B : Recording with Dolby NR type B (The " [B] " indicator will light up.)  
 C : Recording with Dolby NR type C (The " [C] " indicator will light up.)
- 4 Dubbing Speed Buttons (DUBBING SPEED)**  
 Pressing the NORMAL button starts regular speed dubbing from deck A to deck B. Press the HIGH button to perform dubbing at double speed. See page 11.
- 5 Tape Speed Control (TAPE SPEED)**  
 Use this knob to vary the tape speed. The speed can be varied within a range of approximately ±12% according to the position of the tape speed control knob.
- 6 Input Level Control (INPUT LEVEL)**  
 This knob adjusts the recording input level. It affects the level in both channels. See page 9.
- 7 Headphone Level Control**  
 Use this to adjust the output level of the headphones.
- 8 Headphone Select Switch (PHONES SELECT)**  
 Use this to select the headphone's output signal.  
  
 A : The Deck A's signals are output to the headphones.  
 MIX : The MIX signals of Deck A and Deck B are output to the headphones.  
 B : The Deck B's signals are output to the headphones.

- 9 Headphone Jack (PHONES)**  
 For private music enjoyment without disturbing others, or for monitoring a recording, a headphone set may be connected to this jack. Use a headphone with an impedance rating of 8 to 1200 Ω/ohms. Signal are output according to the position of the PHONES SELECT switch **8**.
- 10 Auto Gain Control Switch of Mic (MIC AGC)**  
 Selects the microphone level adjustment method.  
  
 OFF : The level is adjusted with the MIC LEVEL control **13**.  
 ON : The level is adjusted automatically according to the level of the microphone input signal.
- 11 Microphone Jacks (MIC)**  
 Connect the microphone to this jack for microphone mixed recording. MIC signals will be mixed with the line input signals.  
 Accepts an unbalanced (TS Type) microphone with 1/4" mono jacks.  
 When a microphone is only connected to the L/MONO jack, the recording will be monaural. Connect to both the L and R jacks for stereo recording.  
  
**NOTE :**  
 To prevent noise, set the MIC MODE switch **12** to "off" when connecting microphones to the MIC jacks.
- 12 Microphone Mode Switch (MIC MODE)**  
 OFF : Turns the microphone input off.  
 LINE : When in the tape play, record or recording pause mode, the sound input to the microphone is output from the LINE OUT jack. The sound input to the microphone is not recorded.  
 REC : Microphone mixed recording is performed.
- 13 Microphone Input Level Control (MIC LEVEL)**  
 Adjust the level of the Microphone inputs.

**14** Tape Transport Buttons

	Play Button	Press to playback tape.
	Stop Button	Press to stop the tape in any mode.
	Fast Rewind Button	Press for fast rewind.
	Fast Forward Button	Press for fast forwarding.
	Rec/Rec Mute Button	Press the Rec/Rec Mute button (●) and Play button (◀, ▶) simultaneously to start recording. If only the Rec/Rec Mute button (●) is pressed, the deck enters the recording pause mode. Pressing this button in the recording pause mode will start Auto Rec Mute, and a 5-second silent space is recorded onto the tape. See page 9.
	Rec Pause Button	Press this button to enter the recording pause mode from the recording or recording mute mode. This button can only be used during recording. See page 9.

**15** Input Select Switch of Deck B (INPUT SELECT)

Select the audio input to the Deck B (DECK A, LINE A, LINE B).

**16** Cassette Compartment Cover

If the cover is not closed completely, the tape transport buttons will remain inoperative.

**17** Counter Memory Button (COUNTER MEMO)

When this button is pressed during forward tape travel (▶), fast rewinding (◀◀) will stop automatically at the tape counter position "0000".

When this button is pressed during reverse tape travel (◀), fast forwarding (▶▶) will stop automatically at the tape counter position "0000". See page 11.

**18** Counter Reset Button (COUNTER RESET)

Press this button to reset the tape counter to zero.

**19** Eject Button (▲)

Press this button to open the cassette compartment cover. When the tape is running, press the Stop (■) button first to stop tape transport, then press the Eject (▲) button.

**20** Reverse Mode Button (REV. MODE)

Select the type of tape transport. The reverse mode can be set to (one side), (continuous playback), RELAY (relay playback), CASCADE (continuous recording/playback on multiple units is possible).

**21** Twin Recording Button (TWIN REC)

Pressing this button will set both deck A and B to the recording pause mode. See page 10.

**22** Display

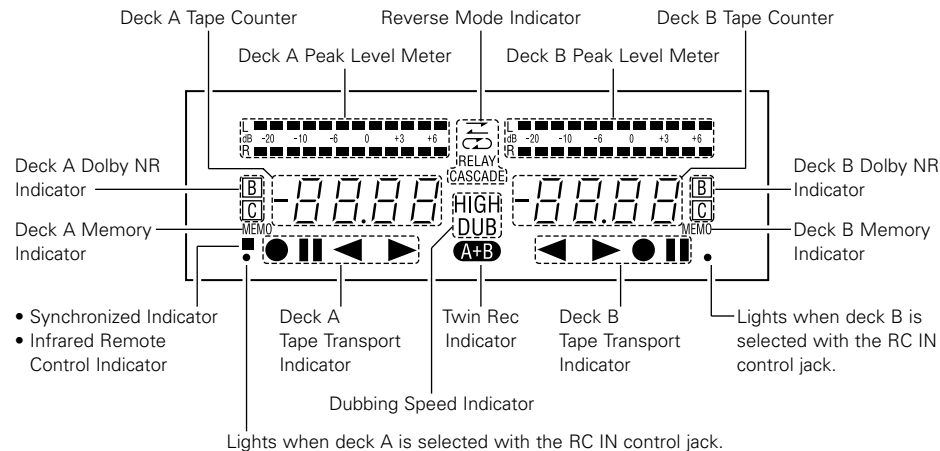

**23** Remote Control Sensor (REMOTE SENSOR)

This sensor receives the infrared light transmitted from the wireless remote control unit. This product does not come with remote control unit.

**24** Deck A, B Line Input Jacks (LINE IN)

These are unbalanced inputs using RCA type jacks. Use them to input signals to be recorded on a tape.

**25** Deck A, B Line Output Jacks (LINE OUT)

These are unbalanced outputs using RCA type jacks.

**26** Deck A Line Output Select Switch (DECK A OUTPUT SEL.)

Selects the signal to be output from the Deck A output jacks.

A: The Deck A signal is output.  
A+B: Both the Deck A and Deck B signals are output.

**27** Deck A Line Input Through Jacks (THRU)

The signal input to the DECK A LINE IN jacks is output unchanged.

**28** External Synchronized Control Jacks (EXT. SYNC.)

Connect these for synchronized recording.

**29** Cascade Control Jacks (CASCADE)

Connect these for continuous operation on multiple units. When the REV. MODE button 20 is set to "CASCADE", the start signal is output from this output jack once operation of Deck B is finished.

**30** Serial Control Port (RS232C)

This is serial remote connector. Applicable connector: 9-pin D-sub (male) Baud rate: 9600 bps Pin layout

Pin No.	Signal Name	I / O
1	GND	-
6	NC	-
2	TxD	O
7	NC	-
3	RxD	I
8	NC	-
4	NC	-
9	NC	-
5	S. GROUND	-

**31 Parallel Remote Control Port (PARALLEL)**

This is a parallel remote connector.  
Applicable connector : 25-pin D-sub (male)  
Connecting signal layout

**NOTE :** All input is active low.

Pin No.	Signal Name	I / O
1	FG	-
14		-
2	TWIN REC	I
15	A COUNTER RESET	I
3	A REWIND	I
16	B COUNTER MEMO	I
4	B FAST FORWARD	I
17	REVERSE MODE	I
5	DUBBING HIGH	I
18	B REC	I
6	B REWIND	I
19	A REC PAUSE	I
7	A PLAY FORWARD	I

Pin No.	Signal Name	I / O
20	A STOP	I
8	A PLAY REVERSE	I
21	DUBBING NORMAL	I
9	A REC	I
22	Command common	-
10	B COUNTER RESET	I
23	B REC PAUSE	I
11	B PLAY FORWARD	I
24	B STOP	I
12	B PLAY REVERSE	I
25	A FAST FORWARD	I
13	A COUNTER MEMO	I

Use the connection example in the diagram below as reference for connecting a parallel remote controller to the DN-780R.

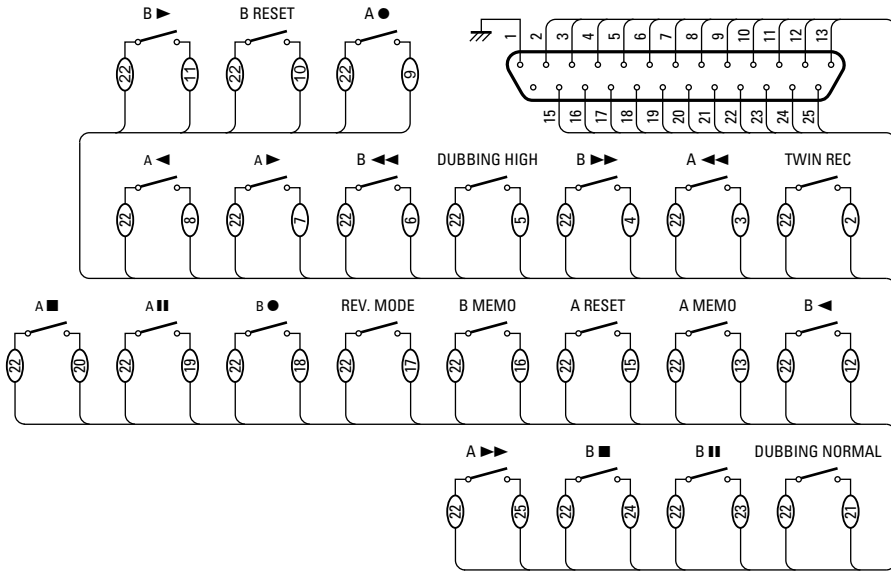

**32 RC IN control Jack**

This is a stereo mini jack for wired remote control.

**1. Circuit Diagram**

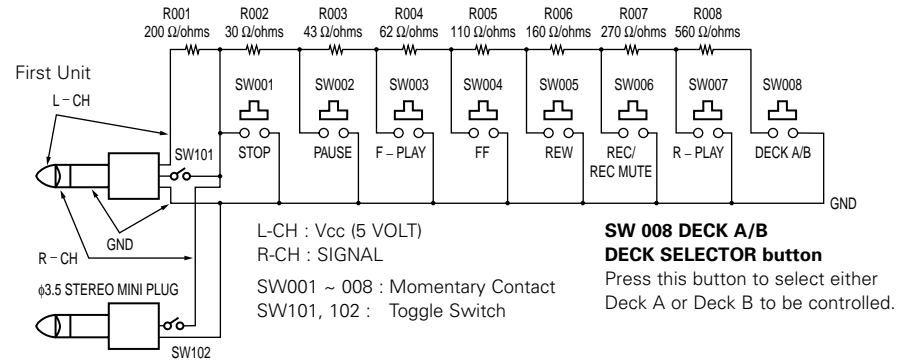

Second and Subsequent Units

- Do not connect the left channel of the plug (Vcc) with R001 (200 Ω/ohms) in the second and subsequent units.
- Use resistors having a tolerance of with ±5%.  
Use of resistors having a poorer tolerance will cause incorrect operation.
- Never short circuit the left-channel line (Vcc). Doing so will damage the main unit.

**2. Operation with Parallel Connections**

A number of DN-780R units can be simultaneously operated in parallel with 1 button.  
Operation with parallel connections can be used with a maximum of 5 units.  
Connection of 6 or more units will lead to indicator operation.

**3. Cable Length**

The longer the length of the cable, the more susceptible the system will be to the effects of external noise.  
Keep cable lengths to 2 m or less.  
Do not locate equipment that produces electrical noise in the vicinity of the cable.  
Doing so might lead to incorrect operation due to the noise.

- Do not disconnect or connect the remote control plug during operation of the unit.  
The pins of the plug might cause a short circuit of the pins inside the jack which can stop the operation.
- Pressing more than one button of the wired remote control box at the same time (for combined operations) is not possible.  
A music search operation will not result from pressing the Play (▶) and Fast Forward (▶▶), or Play (◀) and Rewind (◀◀) buttons at the same time.
- Pressing a button of the wired remote control box and a button of the main unit, DN-780R, (for combined operations) is not possible.

**Note on Connecting the Remote Control Box**

When multiple sets are connected to a single remote control box, the other sets may operate erroneously when this set's power is turned on or off or when the cord is connected or disconnected from the remote control jack.  
Turn off the remote control box' toggle switched (SW101, 102, ...) when turning this set's power on or off or when connecting or disconnecting the cord from the remote control jack while other sets are connected to the remote control box.

## CASSETTE TAPES

### ■ Handling Precautions

- C-120 cassette tapes  
C-120 cassette tapes are not recommended as they use a very thin tape base which may become tangled around the capstan or pinch roller.
- Tape Slack  
Before putting a tape into the deck, take up any slack with a pencil or your finger tip. This precaution prevents the tape from becoming entangled around the capstan or pinch roller.

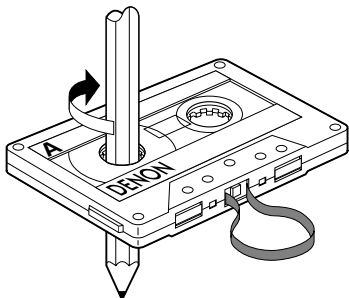

### ■ Storage Precautions

- Do not store cassette tapes in a place where they will be subject to:
  - Extremely high temperature or excessive moisture
  - Excessive dust
  - Direct sunlight
  - Magnetic fields (near TV sets or speakers)
- To eliminate tape slack, store your cassettes in cassette cases with hub stops

### ■ Accidental Erasure Prevention

- All cassettes have erasure prevention tabs for each side. To protect valuable recordings from accidental or inadvertent erasure, remove the tab for the appropriate side with a screwdriver or another tool.
- To record on a tape whose erasure prevention tabs have been removed, cover the tab holes with adhesive tape.

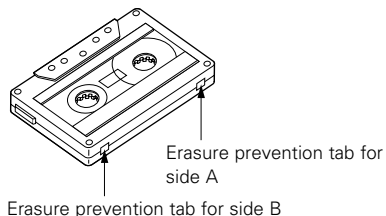

## AUTOMATIC TAPE SELECTION

This Stereo Cassette Deck contains an automatic tape selector which automatically selects the optimum bias and equalization for the tape in use. This is accomplished by detection of the tape type detection holes in the cassette housing.

- If a tape without tape type detection holes is used, the deck will be set for normal tapes.

## PLAYBACK

- The operations described below apply to deck A and deck B alike.
- The numbers in the illustration below depict the order in which operation steps are carried out.

- ① Press the POWER switch ① to the ON ( ) position.
- ② Press the Eject ( ) button ⑯ to open the cassette compartment cover ⑩.
- ③ Load the cassette tape and close the cassette compartment cover ⑩.
- ④ When listening to a tape that has been recorded with Dolby noise reduction, set the DOLBY NR switch ⑤ to match the system used at the time of recording.
- ⑤ Select the type of tape transport with the REV. MODE button ⑳.

Mode	Indicator
To listen to one side only	
To listen to repeat playback of both sides	
To listen to continuous playback of both sides and both decks.	RELAY or CASCADE

- ⑥ Press the Play ( or ) button ⑭ to begin playback. The Play ( or ) indicator will light during playback.
- ⑦ Press the Stop ( ) button ⑮ to stop the playback.
  - If different types of Dolby noise reduction are used for record and playback, playback response will be adversely effected.
  - When power is turned off during tape transport, it may not be possible to remove the cassette by pressing the Eject ( ) button ⑯. In this case, turn on power again before you press the Eject ( ) button ⑯.

### ■ RELAY PLAY (continuous playback of the tapes in deck A and deck B)

- Load a cassette tape into deck A and B, and set the DOLBY NR switch correctly on deck A and B.
- In the relay play mode, the Deck A and Deck B play signals are output from the DECK A LINE OUT jacks.

- ① REV. MODE button ⑳ set to "RELAY".
- ② Press the Play ( or ) button ⑭ of the deck you first wish to listen to. The Play ( or ) indicator of the deck playing back the tape will light up.
- ③ To stop relay play, press the Stop ( ) button ⑮ of the deck currently playing the tape.
  - The number of cycles for relay playback can be selected (1, 5 or 10). For details, refer to "PRESET FUNCTION" (page 11). When playback starts from deck B, when switching to deck A, the first deck A playback cycle will be counted as the second cycle. The completion of cycles will always be at the opposite side of the tape in deck B.
  - If the playback deck has been switched, be sure to start playback in the forward direction ( ).

### NOTE :

In the relay play mode, it is not possible to perform the play operations simultaneously on Decks A and B. If one of the decks is set to the play mode while the other deck is already in the play mode, playback is performed on the deck that has just been set to the play mode and stops on the other deck.

### ■ TWIN OUTPUT

With the DN-780R, it is possible to play tapes simultaneously on decks A and B and output their signals at the same time.

When both decks A and B are played, the signals for deck A are output from the DECK A LINE OUT jacks, and the signals from deck B are output from the DECK B LINE OUT jacks..

- The DECK B LINE OUT jacks are exclusively for the deck B signals.
- The DECK A LINE OUT jacks are for both the deck A and deck B signals when deck A line output select switch set to "A+B".
- Use the DECK A LINE OUT jacks when connecting one of the sets of line outputs to a receiver or amplifier.



**MUSIC SEARCH SYSTEM**

The music search system detects blank sections (lasting for at least 4 seconds) between selections in order to locate the beginning of selections in the forward or reverse direction.

- To advance from the current selection to the beginning of the next selection (CUE) :  
Press the Play (▶) button simultaneously with the Fast Forward (▶▶) button. Press the Play (◀) button simultaneously with the Rewind (◀◀) button.  
The deck will skip the rest of the current selection and automatically resume play from the beginning of the next selection.

- To repeat playback from the beginning of the current selection (REVIEW) :  
Press the Play (▶) button simultaneously with the Rewind (◀◀) button. Press the Play (◀) button simultaneously with the Fast Forward (▶▶) button.  
The deck will rewind the tape to the beginning of the current selection and automatically resume play from that point.  
This is very convenient for repeating playback of the current selection.

**Notes on Music Search Operation :**

- The search functions operates by detecting comparatively long, blank sections approximately 4 to 5 seconds long, in between recorded selections. Therefore, the system may not operate normally in the following cases:
- Recordings with discontinuous speech or conversation.
  - Recordings with long periods of pianissimo (softly played music).
  - Blank sections with a high level of noise.
  - Blank sections shorter than 4 seconds.
  - If noise-emitting appliances, such as electric razors, drills, refrigerators, etc., are operated nearby.
  - REVIEW close to the beginning of the program or CUE close to the ending.

**POWER ON PLAYBACK**

Playback starts automatically when the power is turned on.

- Playback is performed according to the reverse mode set when the power was turned off.
- Playback is performed even if a cassette tape is only loaded in one deck.
- Playback always starts in the “▶” tape travel direction.
- When tapes are loaded in both Deck A and Deck B, playback starts from Deck A.
- The power on playback function can be set with the “PRESET FUNCTION” (page 11).

**RECORDING**

- The operations described below apply to deck A and deck B alike.

- Press the POWER switch ❶ to the ON (■) position.
- Load the cassette tape ❸, ❹.  
(Check that the erasure prevention tabs of the cassette housing have not been broken off.)
- Select the Dolby NR type that suits the recording.
- Select the type of tape transport with the REV. MODE button ❷.

Mode	Indicator
To record on only one side	
To continuously record on both sides	RELAY or CASCADE

- Press the Rec/Rec Mute (●) button ❶ to set the recording pause mode. The ● indicator will light up.
- Adjust the recording level with the INPUT LEVEL control ❷ while watching the Peak Level Meter.
- Recording starts when the Play (◀ or ▶) button ❸ for the direction indicated by the flashing tape travel indicator (◀ or ▶) is pressed. If the other Play (◀ or ▶) button ❸ is pressed, the direction of tape travel changes.  
The Play (◀ or ▶) and the ● indicator will light during recording.
- To stop recording, press the Stop (■) button ❹.
- To pause the recording, press the Rec Pause (■) button ❺. Press the Play (◀ or ▶) button ❸ to resume recording.

**NOTE :**

For Deck B, the input source can be selected. Select the desired line input beforehand using the INPUT SELECT switch.

DECK A : The sound playing on Deck A can be recorded. (Refer to “MANUAL DUBBING” (page 11)).

LINE A : The sound input to the DECK A LINE IN jacks can be recorded.

LINE B : The sound input to the DECK B LINE IN jacks can be recorded.

**Caution :**

Be careful not to erase important recordings by mistake. Inadvertent start of recording will happen in the following cases:

- If the Play (◀ or ▶) button is pressed while the ● indicator lights, recording starts.
- If the Play (◀ or ▶) button and Rec/Rec Mute (●) button are pressed at the same time, recording starts.

The best way to avoid accidental erasure is to break off the two erasure prevention tabs on the cassette housing.

**PROPER RECORDING LEVEL**

A too high recording level can saturate the tape and cause distortion. On the other hand, if the recording level is set too low, soft passages will be marked by residual noise. A proper recording level is the most important factor for making well balanced recordings.

**Guideline for maximum recording level**

Type I (Normal)	+3 dB level on peaks
Type II (CrO <sub>2</sub> )	+3 dB level on peaks
Type IV (Metal)	+3 dB level on peaks

**Note :**

The optimum recording level differs depending on the program source and the type of tape used.

**REC/REC MUTE AND REC PAUSE BUTTONS**

- To record a 5-second blank section during recording:  
Press the Rec/Rec Mute (●) button. A 5-second blank will be recorded and the deck will enter the recording standby mode.
- To record a 5-second blank section during the recording standby mode:  
Press the Rec/Rec Mute (●) button from the recording standby mode. A 5 second blank will be recorded and the deck will enter the recording standby mode again.
- To cancel recording of blank space:  
Press the Rec Pause (■) button. Blank space recording will be cancelled and the deck enters the recording standby mode.
- To extend the blank section with another 5 seconds or more:  
Simply press the Rec/Rec Mute (●) button and the blank section will be increased with another 5 seconds.

■ **AUTO-STANDBY**

This function is extremely convenient when conducting relay recording, relay playback, twin recording or tape copying.

- When the Fast Rewind (◀◀) and Rec Pause (||) buttons are pressed simultaneously while in the stop mode and the tape is set to play in the forward direction (▶), the tape is rewound to the beginning, then played to the end of the leader tape and stopped automatically at the beginning of the magnetic tape.
- When the Fast Forward (▶▶) and Rec Pause (||) buttons are pressed simultaneously while in the stop mode and the tape is set to play in the reverse direction (◀), the tape is fast-forwarded to the end, then played in the reverse direction to the end of the leader tape and stopped automatically at the beginning of the magnetic tape.
- The Play (◀ or ▶) indicator flashes during the auto-standby mode.

**Caution :**

If recording is started after using the auto standby function with a recorded tape, the sound of the previous recording may not be completely erased. In such cases, rewind the tape before starting to record.

■ **TWIN RECORDING (simultaneous recording on deck A and deck B)**

This is a convenient feature for recording the same program source onto two tapes at the same time.

- This function records the source input to the DECK A LINE IN jacks.
- Input the source you want to record to the DECK A LINE IN jacks.
- Load cassette tapes into both deck A and B. Set the DOLBY NR switch (Deck A only) and REV. MODE button.
- In the twin recording mode, only the recording monitor signal of the DECK A LINE OUT jacks is output.

- ① Press the TWIN REC button ②. The A+B indicator will light up and both decks will enter the recording pause mode.
- ② Adjust the INPUT LEVEL-A control ⑥ for the best recording input levels while watching the Peak Level Meter.
- ③ Press the Play (◀ or ▶) button ⑭ (deck A or B) to start twin recording.
- ④ To stop twin recording, press the Stop (■) button ⑮ of each deck.

- By pressing the both deck A and B Rec Pause (||) button ⑬, the recording pause or recording mute mode on both decks can be set automatically.
- To set the twin recording mute mode from the twin recording pause mode, press the Rec/Rec Mute (●) button on both deck A and B for at least 0.5 seconds.
- The relay or cascade mode cannot be set with the REV. MODE button when in the twin recording mode.

■ **RELAY RECORDING (continues recording from deck A to deck B)**

To record a long program, start recording on deck A, and when both sides of the tape in deck A have been recorded, the relay recording feature continues to record on the tape in deck B.

- This function records the source input to the DECK A LINE IN jacks.
- Load cassette tapes into decks A and B, and set the DOLBY NR switch both deck A/B.

- ① REV. MODE button ⑳ set to "RELAY". The RELAY indicator will light.

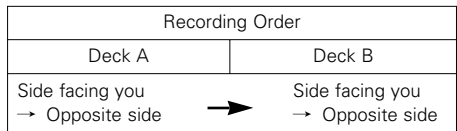

- ② Adjust the INPUT LEVEL control ⑥ of both deck A and B for the best recording input level while watching the Peak Level Meter.
- ③ Press the Rec/Rec Mute (●) button ⑮ of deck A to set the recording pause mode.
- ④ Press the Play (◀ or ▶) button ⑭ of deck A to start relay recording.
- ⑤ To stop relay recording, press the Stop (■) button ⑮ of the deck that is recording. If recording has been switched from Deck A to Deck B, be sure to start recording in the forward direction (▶).

**NOTE :**

In the relay recording mode, it is not possible to perform the recording operations simultaneously on Decks A and B. Nothing happens if the recording operation is performed on one of the decks while the other deck is already in the recording mode.

■ **SYNCHRONIZED OPERATION**

- The synchro function can be used when the DN-780R is used together with a Denon product equipped with an EXT. SYNC. IN/OUT jack.
- Twin recording in sync with another DN-780R is possible.
- Use a single RCA cable to connect the units' EXT. SYNC. OUT jacks with the units' EXT. SYNC. IN jacks.

- ① Press the TWIN REC button ② on one of the units. The twin recording command is output from the EXT. SYNC. OUT jack and the other unit is set to the twin recording mode.
- ② Press the Play (◀ or ▶) button ⑭ on one of the units. The play command is output from the EXT. SYNC. OUT jack and twin recording also starts on the other unit.
- ③ Press the Stop (■) button ⑮ on one of the units. The stop command is output from the EXT. SYNC. OUT jack and the other unit is also set to the stop mode.

## DUBBING (from deck A to deck B)

- ① Press the POWER switch (●) to the ON (■) position.
- ② Load the cassette tape to be played in deck A and the one to be recorded in deck (19, 16).
- ③ Select the type of tape transport with the REV. MODE button (20).

Reverse mode	Operation
	Dubbing is performed only for one side. The decks stop when either deck A or B reaches the end of the tape.
	The tape direction is reversed on each deck when they reach the end of the tape. (This is convenient for dubbing to a tape with a different length.)
RELAY or CASCADE	During dubbing of the side facing you, the deck that first reaches the end of the tape will stand by until the other deck reaches the end of the tape, then both decks will reverse the tape direction together. (Depending on the manufacturer, the length of tapes having the same recording time may differ somewhat. Setting this mode permits the arrangement of the beginning portion of the opposite side of the tape.)

- ④ To begin normal speed dubbing, press the DUBBING SPEED NORMAL button (4). The DUB indicator will light at this time. To high speed dubbing, press the DUBBING SPEED HIGH button (4). The HIGH indicator will light at this time.
- ⑤ To stop dubbing, press the Stop (■) button (14) of deck A or deck B.

- When dubbing, the recording level and the Dolby NR coding will be the same as those of the playback tape, regardless of the positions of the INPUT LEVEL control and the DOLBY NR switch.
- When listening to the playback sound during normal speed dubbing, set the DOLBY NR switch to match the Dolby NR system with which the playback tape was recorded. This will assure correct sound reproduction, but does not affect the recording.
- The playback sound cannot be heard during high speed dubbing.
- Operation using the Rec/Rec Mute (●) and Rec Pause (■) buttons of deck B is permitted during normal speed dubbing.
- Buttons other than the Stop (■) button cannot be used during high speed dubbing.
- In the normal speed dubbing mode, play signals are only output from the DECK A LINE OUT jacks. In the high speed dubbing mode, no sound is output.

### MANUAL DUBBING

- With this function, the signal played on Deck A can be recorded manually on the tape in Deck B.
- The manual dubbing function is also used to record the signal of the Deck A tape with which the microphone input signal has been mixed onto the tape in Deck B.

- ① Perform steps ③ to ⑤ in the "PLAYBACK" section on Deck A.
- ② Perform steps ② to ⑤ in the "RECORDING" section on Deck B. Set to Deck B INPUT SELECT switch to Deck A.
- ③ Set deck A to the play mode and adjust the recording level using the INPUT LEVEL-B control (6).
- ④ Connect microphones to the MIC jacks (1) and set the MIC MODE switch (12) to the "REC" mode.
- ⑤ Set the microphone input level with the MIC INPUT LEVEL control (18). Also set the MIC AGC switch (10) to "ON".
- ⑥ Start playback on Deck A and recording on Deck B.

### NOTE :

This operation is not possible if the reverse mode is set to RELAY or CASCADE.  
To prevent noise, set the MIC MODE switch to "off" when connecting microphones to the MIC jacks.

## MEMORY STOP

### 1. MEMORY STOP Operation

- (1) During recording or playback, the Memory Stop feature can be used to locate a particular point on the tape. Press the COUNTER MEMO button at the desired point.
- (2) The MEMO indicator lights.
- (3) When the Rewind (◀◀) button is pressed during forward tape travel (▶), or the Fast Forward (▶▶) button is pressed during reverse tape travel (◀), the tape is rapidly rewound (or advanced) until the counter indication of "0000" is reached.

- The Memory Stop feature will rewind or forward the tape to within -5 counts in the forward (▶) direction (from "0000" to "-0005") and to within +5 counts in the reverse (◀) direction (from "0000" to "0005").
- The Memory Stop function operation independently in both directions for deck A and deck B.

### Caution :

If the memory stop operation is performed after repeated fast-forwarding or rewinding, the tape may not stop at the proper position.

## PRESET FUNCTION

- Use these functions to preset the DN-780R's operation modes. These presets are stored in permanent memory, so they are not cleared even when the power is turned off.
- The preset procedure can be performed in the stop mode of both the deck A and deck B.

- ① Press the Stop (■) button (14) on Deck A and the Stop (■) button (14) and REV. MODE button (20) on Deck B simultaneously.
- ② Press the Play (▶) button (14) on Deck A and select the preset item.

### Preset items :

- 1) Setting of number of cycles for "↻" or "RELAY MODE"
- 2) Setting of power on play mode (on or off)
- 3) Setting of infrared remote control codes to be received
- 4) Infrared remote control sensor setting (on or off)

### 2. Display Back-up

The COUNTER VALUE, MEMO, DIRECTION and REV. MODE functions are protected for approximately one month by a memory back-up. Once the back-up period is up, the MEMO settings are set to off, the DIRECTION setting is set to ▶, and the counter is reset to "0000".

- ③ Press the Play (▶) button (14) on Deck B to change the settings.
  - 1) Number of cycles for the relay mode  
 "Loop 1" : Stop relay play after 1 cycle.  
 \*"Loop 5" : Stop relay play after 5 cycles.  
 "Loop 10" : Stop relay play after 10 cycles.
  - 2) Power on play setting (on/off)  
 "P-on P on" : Power on play on  
 \*"P-on P off" : Power on play off
  - 3) Infrared remote control codes to be received  
 \*"rc don" : Receive Denon codes.  
 "rc rc-5" : RC-5 codes can be received.
  - 4) Infrared remote control sensor setting (on/off)  
 \*"ir on" : Accept infrared remote control signals.  
 "ir off" : Do not accept infrared remote control signals.  
 "\*" indicates the default setting.
- ④ The preset mode is canceled when the Stop (■) button (14) on Deck A or Deck B is pressed. The settings are written at this time.

## DOLBY B AND C NOISE REDUCTION SYSTEM

- The Dolby noise reduction system substantially reduces the tape background noise (hiss) inherent in the cassette medium. Dolby B NR is most widely in use. However Dolby C NR is a much more recent development and represents significant improvements over Dolby B NR.
- Tape background noise consists primarily of high frequency information, which is particularly annoying during soft passages. The Dolby NR system increases the level of low volume mid- and high-frequency signals during recording and reduces the level of these signals by an identical amount during playback. As a result, the playback signal is identical to the original source, but the level of background noise generated by the tape is greatly reduced.
- The operating principle of Dolby C NR is similar to that of Dolby B NR except for the encoding /decoding response curves. The noise reduction effect obtained with Dolby C NR is up to 20 dB, compared to 10 dB with Dolby B NR. In addition, Dolby C NR uses an anti-saturation network and spectral skewing circuitry for a significant improvement in the dynamic range of the mid- to high-frequencies.

## DOLBY HX-PRO HEADROOM EXTENSION SYSTEM

This deck is equipped with the Dolby HX-PRO headroom extension system. Since the system functions automatically during recording, no switching operation or adjustment is required. The system is effective with any type of Normal, CrO<sub>2</sub> and Metal tape.

The Dolby HX-PRO headroom extension system functions during recording to raise the saturation level in the treble range. Therefore, most of the treble range components distorted or lost during recording on conventional cassette decks are more faithfully recorded on the new DENON cassette deck.

### Features of the Dolby HX-PRO Headroom Extension System

- (1) Performance of Normal and CrO<sub>2</sub> tapes can be improved to very close of that offered by Metal tape.
- (2) The dynamics in the treble range are improved significantly.
- (3) Since no decoding is necessary during playback, the improved sound can be enjoyed on any type of tape deck, including portable players and car audio systems.
- (4) The system functions whether the Dolby B/C NR system is engaged or not.

## MAINTENANCE

### ■ Head cleaning

After long usage, tape coating or dust may adhere to the heads, causing deterioration of sound. Therefore, the parts depicted in the illustration should be cleaned regularly. Use a cotton swab moistened with a tape head cleaning solution (such as alcohol).

### NOTES :

1. Some cleaning cassettes on the market have a strong abrasive effects and may scratch the heads. Always use cotton swabs instead of cleaning cassettes.
2. Since the use of metal tape is apt to collect more dust on the heads, the heads should be cleaned more often to enjoy the best possible sound.

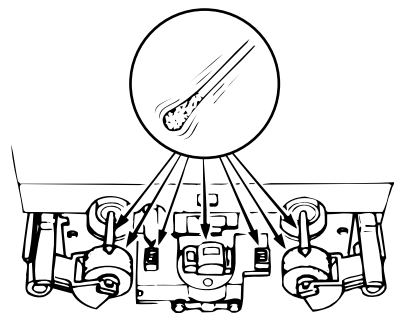

### ■ Cleaning the Pinch Rollers and Capstans

If the pinch rollers or capstans accumulate dust, tape transport may become unstable, as a result from slippage, during recording or playback. The tape can also be damaged if it gets entangled in the capstan.

Clean these parts with a cotton swab or a soft cloth moistened with a tape head cleaning solution (such as alcohol).

### ■ Demagnetizing the Heads

The heads will become magnetized after long usage or if strongly magnetized objects are brought near them. The result is a generation of noise, loss of the high frequency range, and in extreme cases erasure of treble components on pre-recorded tapes in combination with added noise.

Thus, the heads should be demagnetized at regular intervals. (Head demagnetizers are separately available from your dealer.)

### ■ How to Demagnetize the Tape Heads

1. Turn off the power.
2. Turn on the demagnetizer while it is at least 30 cm away from the heads. Bring the demagnetizer near the heads and slowly move it in small circles four or five times in front of each head, making sure you do not touch them.
3. Slowly move the demagnetizer away and turn it off when it is at least 30 cm away from the heads.

## TROUBLESHOOTING

Check the following before you draw the conclusion that your Stereo Cassette Deck is malfunctioning.

1. Are all the connections correct?
2. Are all system components being operated correctly in accordance with the operating instructions?
3. Are the speakers and amplifier/receiver functioning correctly?

If the tape deck still does not function properly, check the symptom against the list below. If the symptom does not correspond to the check list, please contact your DENON dealer.

Problem	Cause	Remedy
Tape does not run.	<ul style="list-style-type: none"> <li>• Power cord is disconnected.</li> <li>• Tape is loose.</li> <li>• Cassette is not loaded properly.</li> <li>• Defective cassette.</li> </ul>	<ul style="list-style-type: none"> <li>• Check power cord.</li> <li>• Tighten tape with a pencil, etc.</li> <li>• Load cassette properly.</li> <li>• Replace cassette.</li> </ul>
Tape is not recorded when Rec/Rec Mute (●) button is pressed.	<ul style="list-style-type: none"> <li>• No cassette is loaded.</li> <li>• Erase prevention tabs are broken off.</li> </ul>	<ul style="list-style-type: none"> <li>• Load cassette.</li> <li>• Cover holes with adhesive tape.</li> </ul>
Sound is warbled or distorted.	<ul style="list-style-type: none"> <li>• Heads, capstan or pinch roller are dirty.</li> <li>• Tape is wound too tight.</li> <li>• Recording input level is too high.</li> <li>• Tape is worn out and has "drop-outs".</li> </ul>	<ul style="list-style-type: none"> <li>• Clean them.</li> <li>• Fast forward or rewind to loosen tape winding.</li> <li>• Adjust recording input level.</li> <li>• Replace tape.</li> </ul>
Excessive noise.	<ul style="list-style-type: none"> <li>• Tape is worn.</li> <li>• Heads, capstan or pinch roller are dirty.</li> <li>• Heads are magnetized.</li> <li>• Recording input level is too low.</li> </ul>	<ul style="list-style-type: none"> <li>• Replace tape.</li> <li>• Clean them.</li> <li>• Demagnetize heads.</li> <li>• Adjust recording input level.</li> </ul>
High frequency range (treble) is emphasized.	<ul style="list-style-type: none"> <li>• DOLBY NR switch is set improperly.</li> </ul>	<ul style="list-style-type: none"> <li>• Set DOLBY NR switch properly.</li> </ul>
High frequency range (treble) is lost.	<ul style="list-style-type: none"> <li>• Heads are dirty.</li> <li>• Tape is worn.</li> </ul>	<ul style="list-style-type: none"> <li>• Clean them.</li> <li>• Replace tape.</li> </ul>
The cassette tape cannot be removed.	<ul style="list-style-type: none"> <li>• If the POWER switch is turned off either during recording or playback and the unit is stopped, there may be cases when the cassette cannot be removed, even if the Eject (▲) button is pressed.</li> </ul>	<ul style="list-style-type: none"> <li>• Turn the POWER switch ON (■) again, and then press the Stop (■) button.</li> <li>• Now, press the Eject (▲) button to remove the cassette tape.</li> </ul>

## SPECIFICATIONS

<b>Type</b>	Vertical tape loading; 4-track 2-channel stereo double cassette deck
<b>Heads</b>	Recording/playback head (hard parmalloy) x 2 Erase head (Double-gap ferrite) x 2
<b>Motors</b>	Capstan (DC servo motor) x 2 Real (DC motor) x 2
<b>Tape Speed</b>	4.8 cm/sec.
<b>Variable (PLAY)</b>	Approx. ±12%
<b>Fast Forward, Rewind Time</b>	Approx. 110 sec. with a C-60 cassette
<b>Recording Bias</b>	Approx. 105 kHz
<b>Overall S/N Ratio (at 3% THD level)</b>	Dolby C NR on: more than 74 dB (CCIR/ARM)
<b>Overall Frequency Response</b>	20 ~ 18,000 Hz ±3 dB (at -20 dB, Metal tape)
<b>Channel Separation</b>	More than 40 dB (at 1 kHz)
<b>Wow &amp; Flutter</b>	0.06% WRMS, ±0.14% w. peak
<b>Input Sensitive LINE</b>	50 mV (input level maximum) Input impedance : 240 kΩ/kohms unbalanced 0.775mV (mic level maximum)
<b>MIC</b>	
<b>Output Level LINE</b>	775 mV (0 dB) (with 47 kΩ/kohms load, recorded level of 200 pwb/mm)
<b>PHONES</b>	7 mW output level at maximum (33 Ω/ohms)
<b>Power Supply</b>	U.S.A., Canada and Taiwan R.O.C. models : 120 V AC±10%, 60Hz European models : 230 V AC±10%, 50Hz
<b>Power Consumption</b>	33W
<b>Dimensions</b>	483 (W) x 134 (H) x 275 (D) mm
<b>Mass</b>	6.5 kg (14 lbs 5 oz)
<b>Installation</b>	19-inch rack mountable (3U)

For improvement purposes, specifications and design are subject to change without notice.

Dolby noise reduction and HX Pro headroom extension manufactured under license from Dolby Laboratories Licensing Corporation. HX Pro originated by Bang & Olufsen.

"DOLBY", the double-D symbol  and "HX PRO" are trademarks of Dolby Laboratories Licensing Corporation.

**DENON, Ltd.**

16-11, YUSHIMA 3-CHOME, BUNKYOU-KU, TOKYO 113-0034, JAPAN  
Telephone: (03) 3837-5321

Printed in Japan 511 3918 000

# DENON

**STEREO CASSETTE TAPE DECK**

# **DN-780R**

**APPLICATIONS**

**Expanded Function Operating Procedures**

## Expanded Function Operating

Multiple units of the DN-780R can be used together for longer recording and play times, simultaneous recording and other functions.

### ■ CASCADE OPERATION

- Refer to figure 1 on page 10 to connect the equipment.
- Use a single RCA cable to connect the units' CASCADE OUT jacks with the units' CASCADE IN jacks.
- When the first and last units are connected as shown in figure 1 on page 10, recording and playback are performed endlessly. Note that in the recording mode, previous recordings are overwritten.
- If the first and last units are not connected, operation stops at the last unit.

### CASCADE PLAYBACK

- (1) Load the cassette tapes you want to play in both decks of all the units and make sure the Dolby NR modes are properly set.
- (2) Use the REV. MODE button **20** to set the reverse mode of all the units to "CASCADE".
- (3) Press the Deck A Play (◀ or ▶) button **14** on unit 1. Playback starts.
  - Once playback on Deck A ends, Deck B starts playing.
  - Once playback on Deck B ends, playback starts in the forward direction on unit 2's Deck A.
 \* In the cascade playback mode, the playing signals of decks A and B are output from the Deck A Line Output jacks.
- (4) Playback stops when the Stop (■) button **14** on the deck currently playing is pressed.

### CASCADE RECORDING

- Use RCA cables to connect the units' THRU jacks with the units' Deck A Line Input jacks.
- This function can be used when up to 20 units of the DN-780R are connected.

- (1) Load cassette tapes on which nothing is recording into both decks of all the units and set the Dolby NR modes. Adjust the recording level for both Deck A and Deck B.
- (2) Use the REV. MODE button **20** to set the reverse mode of all the units to "CASCADE".
- (3) Press the Rec/Rec Mute (●) button **14** on Deck A of all the units.
  - \* Check that all Decks A are set to the recording pause mode.
  - \* Also set the direction of tape travel at this time.
- (4) Press the Deck A Play (◀ or ▶) button **14** on unit 1. Recording starts.
  - Once recording on Deck A ends, recording starts on Deck B.
  - Once recording on Deck B ends, recording starts on Deck A of the next unit.
  - Deck A is set to the recording pause mode on unit on which recording has ended.
 \* With cascade recording, the source input to the Deck A Line Input jacks is recorded.  
 \* Cascade recording stops if Deck A of any of the units is set to anything other than the recording pause mode.
- (5) Recording stops when the Stop (■) button **14** on the deck currently recording is pressed. After doing this, press the Stop (■) buttons **14** on all the decks.

### ■ SYNCHRONIZED RECORDING

The synchronized recording can be used when the DN-780R is used in combination with other units.

- Refer to figure 2 on page 10 to connect the equipment.
- Use a single RCA cable to connect the units' EXT. SYNC. OUT jacks with the units' EXT. SYNC. IN jacks.
- Use RCA cables to connect the units' THRU jacks with the units' Deck A Line Input jacks.
- This function can be used when up to 20 units of the DN-780R are connected.
- \* Set the infrared remote sensors of all the units to "OFF" when using this function. Also set the same infrared remote control codes for all the units. (Refer to 3) and 4) under "PRESET FUNCTION" in the separate operating instructions.)  
Failure to make these settings could result in malfunction.

- (1) Set the first unit's Master/Slave switch **2** to MASTER, the other units Master/Slave switches **2** to SLAVE.
- (2) Load the master (source) tape in Deck A of the first (Master) unit. Load unrecorded cassette tapes into all the other (Slave) decks.
- (3) Set the units' reverse modes.
  - ☰ : Recording stops after one side.
  - ↻ : For all decks, once recording on side A is completed, recording starts on side B.**RELAY** or **CASCADE** : If there is a difference of less than 30 seconds in the time at which the side A tape ends are detected for all the decks, recording starts on side B of all the decks at the same time.
  - \* Be sure to set all the connected units to the same reverse mode.
- (4) Press the TWIN REC button **21** on the first unit.
  - On the first unit (the one set to the master mode), Deck B is set to the recording pause mode and "DUB" and "A+B" light.
  - For the units set to the slave mode, both Deck A and Deck B are set to the recording pause mode, "A+B" lights, and the level meter and Dolby indicator turn off.
- (5) Press the DUBBING SPEED button **4** to select the copying speed.
  - NORMAL** : Recording is performed at the normal speed.
  - HIGH** : Recording is performed at double the normal speed.
- (6) Press the first unit's Play (◀ or ▶) button **14**. Recording starts on all the connected units.
  - \* When recording a master tape recorded in Dolby NR, the slave tapes are recorded in the same Dolby NR mode as the master tape.
  - \* The recording level is the same as the recording level for the master tape.
  - \* Sound is output during recording, regardless of the copying speed.

#### NOTES:

- Use tapes of the same times (lengths) as far as possible.
- Do not operate the Master/Slave switches **2** during synchronized recording. If a Master/Slave switch **2** is operated, that unit stops.

- (7) Press the Stop (■) button **14** on the first unit to stop recording on all the connected units.



Figure 1

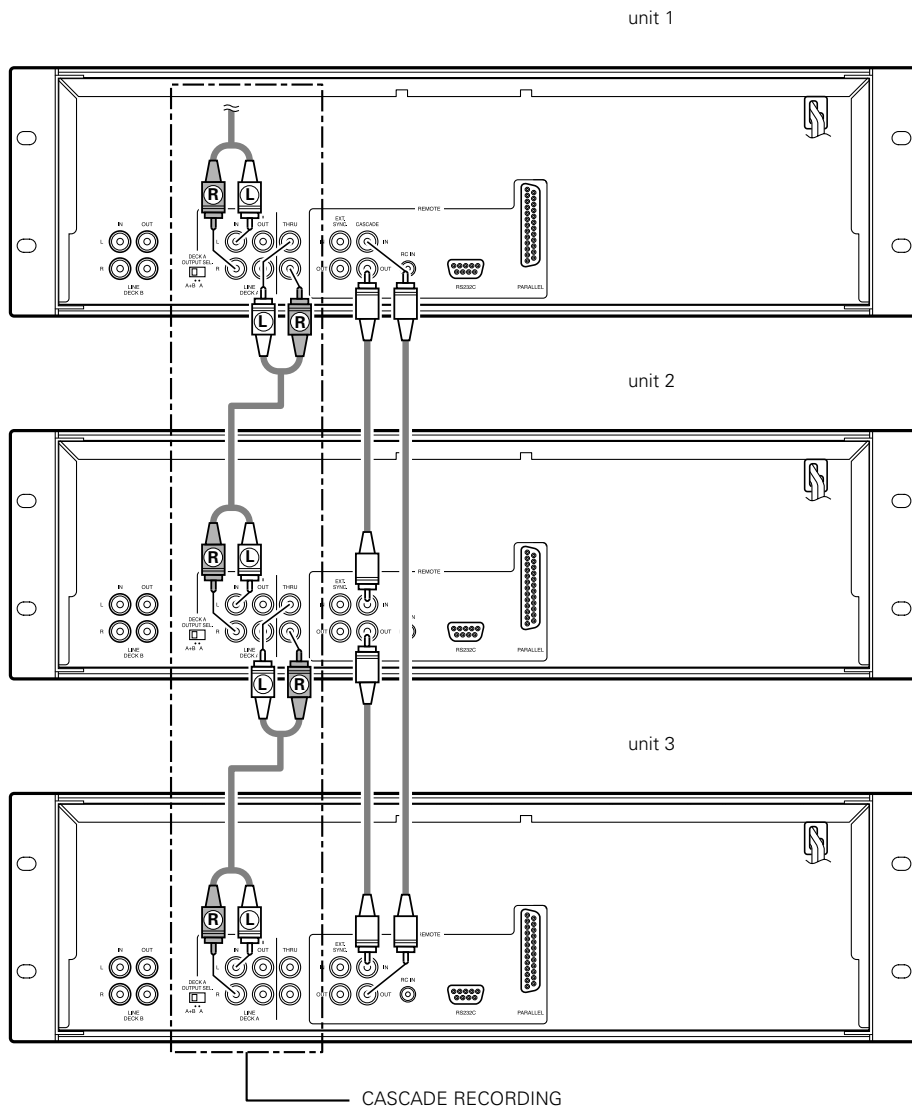
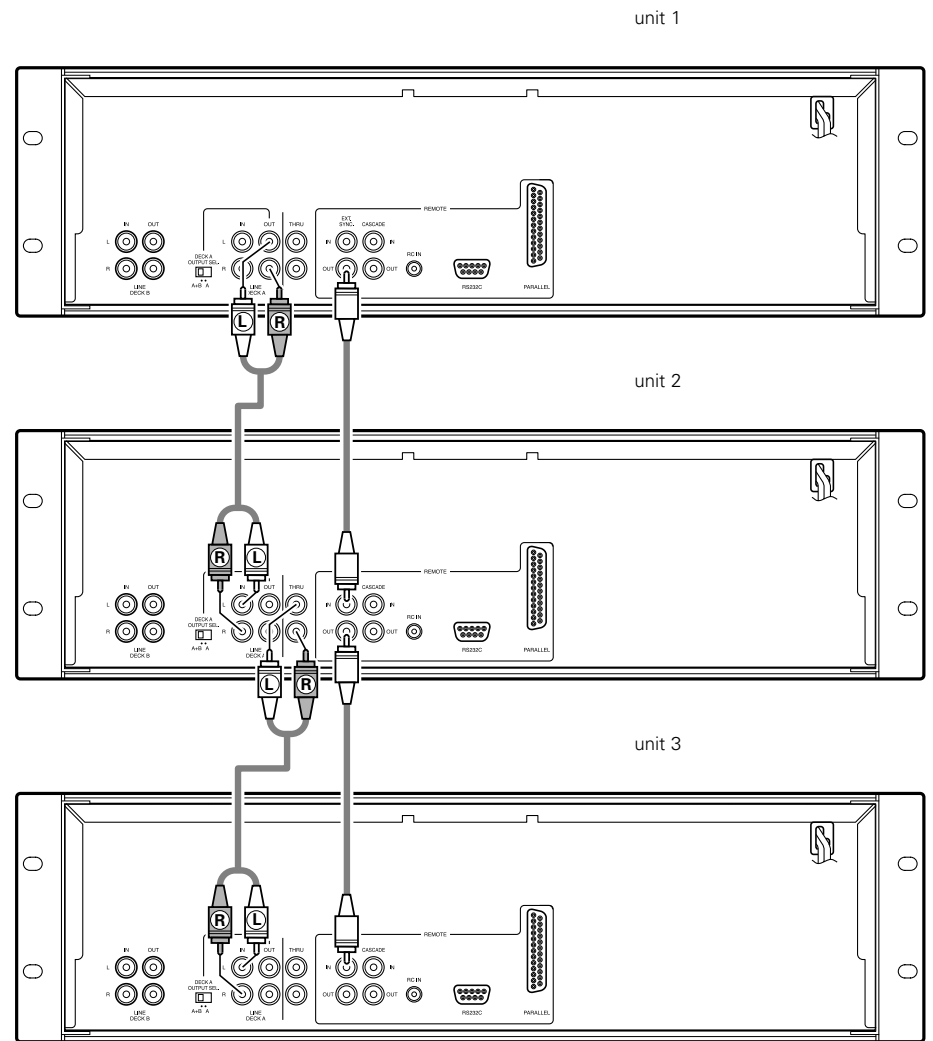

Figure 2



## **DENON, Ltd.**

16-11, YUSHIMA 3-CHOME, BUNKYOU-KU, TOKYO 113-0034, JAPAN  
Telephone: (03) 3837-5321