

# Intelligent High Speed Dome Camera

## Instruction Manual

( English Version )

24 VAC ~ 60 Hz

Model No: **CDC2500MI**

Model No: **CDC2500MXO**

**Indoor Version**



**Outdoor Version**



### **Costar Video Systems**

2720 Commodore Drive, Suite 150

Carrollton TX 75007

Tel: 972-446-8844

Fax: 972-446-8866

Please read this manual thoroughly before use or installation and keep it handy for future reference.

Rev. M080415

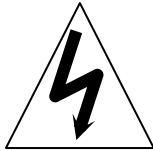
**THIS PAGE IS INTENTIONALLY LEFT BLANK**

# WARNINGS AND CAUTIONS

## WARNING

TO REDUCE THE RISK OF FIRE OR ELECTRIC SHOCK, DO NOT EXPOSE THIS PRODUCT TO RAIN OR MOISTURE. DO NOT INSERT ANY METALLIC OBJECTS THROUGH VENTILATION GRILLS OR OPENINGS ON THE EQUIPMENT.

## CAUTION



## EXPLANATION OF GRAPHICAL SYMBOLS



The lightning flash with arrowhead symbol, within an equilateral triangle, is intended to alert the user the presence of non-insulated “dangerous voltage” within the product’s enclosure that maybe of sufficient magnitude to constitute a risk of electric shock to different persons.



The exclamation point within an equilateral triangle, is intended to alert the user the presence of important operating and maintenance (servicing) instructions in the literature accompanying this product

### PRECAUTIONS:

1. Persons without technical qualifications should not attempt to operate this dome device before reading this manual thoroughly.
2. Remove any power to the dome before attempting any operations or adjustments inside the dome cover to avoid potential damage to the mechanism.
3. Inside the dome cover there are precision optical and electrical devices. Heavy pressure, shock and other sudden adjustments or operations should be avoided. Otherwise, you may cause irreparable damage to the product.
4. Please DO NOT remove or disassemble any internal parts of the video camera to avoid normal operation and possibly void the warranty. There are no serviceable parts inside the camera.
5. All electrical connections to the dome should be made in strict accordance with the attached labels and wiring instructions in this manual. Failure to do so may damage the dome beyond repair and void the warranty.
6. For outdoor installation especially in high places or poles, it is highly recommended that the proper lightning arrestors and surge suppressors are installed before the dome is entered into service.
7. Please do not use the product under circumstances where the limits exceed the maximum specified temperature, humidity or power supply specifications.

## **FCC COMPLIANCE STATEMENT**

**FCC INFORMATION:** THIS EQUIPMENT HAS BEEN TESTED AND FOUND TO COMPLY WITH THE LIMITS OF A CLASS A DIGITAL DEVICE, PURSUANT TO PART 15 OF THE FCC RULES. THESE LIMITS ARE DESIGNED TO PROVIDE REASONABLE PROTECTION AGAINST HARMFUL INTERFERENCE WHEN THE EQUIPMENT IS OPERATED IN A COMMERCIAL ENVIRONMENT. THIS EQUIPMENT GENERATES, USES, AND CAN RADIATE RADIO FREQUENCY ENERGY AND IF NOT INSTALLED AND USED IN ACCORDANCE WITH THE INSTRUCTION MANUAL, MAY CAUSE HARMFUL INTERFERENCE TO RADIO COMMUNICATIONS. OPERATION OF THIS EQUIPMENT IN A RESIDENTIAL AREA IS LIKELY TO CAUSE HARMFUL INTERFERENCE IN WHICH CASE THE USER WILL BE REQUIRED TO CORRECT THE INTERFERENCE AT HIS OWN EXPENSE.

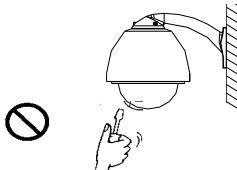
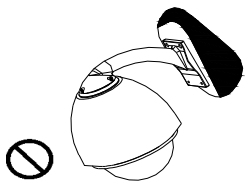
**CAUTION:** CHANGES OR MODIFICATIONS NOT EXPRESSLY APPROVED BY THE PARTY RESPONSIBLE FOR COMPLIANCE COULD VOID THE USER'S AUTHORITY TO OPERATE THE EQUIPMENT.

THIS CLASS A DIGITAL APPARATUS COMPLIES WITH CANADIAN ICES-003.  
CET APPAREUIL NUMERIQUE DE LA CLASSE A EST CONFORME A LA NORME NMB-003  
DU CANADA

## **CE COMPLIANCE STATEMENT**

THIS IS A CLASS A PRODUCT, IN A DOMESTIC ENVIRONMENT THIS PRODUCT MAY CAUSE RADIO INTERFERENCE IN WHICH CASE THE USER MAY BE REQUIRED TO TAKE ADEQUATE MEASURES.

## IMPORTANT SAFEGUARDS

1. Read these instructions before attempting installation or operation of dome device
2. Keep these instructions for future reference
3. Heed all warnings and adhere to electrical specifications
4. Follow all instructions
5. Clean only with non abrasive dry cotton cloth, lint free and approved acrylic cleaners A diagram showing a hand pointing at a dome camera mounted on a wall. A prohibition sign (a circle with a diagonal line) is placed to the left of the hand, indicating that touching the camera is not allowed.
6. Should the lens of the camera become dirty, use special lens cleaning cloth and solution to properly clean it.
7. Do not block any ventilation openings.
8. Install in accordance with manufacturer's instructions
9. Use only attachments or accessories specified by the manufacturer
10. Verify that the surface you are planning to use for attaching the dome can adequately support the weight of the device and mounting hardware A diagram showing a dome camera being attached to a surface. A prohibition sign (a circle with a diagonal line) is placed to the left of the camera, indicating that the surface must be suitable for supporting the device.
11. Protect this devices against lightning storms with proper power supplies
12. Refer all servicing to qualified service personnel. Servicing is required when the device has been damaged in any way, when liquid traces are present, or the presence of loose objects is evident or if the device does not function properly, or has received sever impact or has been dropped accidentally.
13. Indoor dome is for indoor use only and not suitable for outdoor or high humidity locations. Do not use this product under circumstances exceeding specified temperature and humidity ratings.
14. Avoid pointing the camera directly to the sun or other extremely bright objects for prolonged period of time avoiding the risk of permanent damages to the imaging sensor.
15. The attached instructions are for use by qualified personnel only. To reduce the risks of electric shock do not perform any servicing other than contained in the operating instructions unless you are qualified to do so.
16. During usage, user should abide by all electrical safety standards and adhere to electrical specifications for the operation of the dome. The control cable for RS485 communications as well as the video signal cables should be isolated from high voltage equipment and or high voltage cables.
17. Use Certified / Listed Class 2, 24 VAC power supply transformer only.

# Table of Contents

<b>1</b>	<b>Chapter 1 – Introduction</b>	
1.1	Performance Characteristics .....	6
1.2	Features and Functions .....	7
<b>2</b>	<b>Chapter 2 – Installation and configuration</b>	
2.1	Package contents.....	8
2.2	Camera installation .....	9
2.3	Camera Shroud installation.....	11
2.4	Wall bracket installation .....	12
2.5	Attaching the dome to the bracket .....	13
2.6	Installation of the acrylic dome cover.....	14
2.7	Wiring Specifications.....	15
<b>3</b>	<b>Chapter 3 – Wiring and Setup</b>	
3.1	Basic Configuration .....	16
3.2	Connecting Multiple Domes.....	17
3.3	Communication settings. ....	18
3.4	Setting protocol and baud rate of dome device.....	18
3.5	Address setting of each dome .....	18
<b>4</b>	<b>Chapter 4 – Quick Start Operation Guide</b>	
4.1	Wiring.....	19
4.2	Setting protocol and baud rate. ....	19
4.3	Setting the device address. ....	20
4.4	Connect the power to the dome. ....	20
4.5	Joystick controller setting. ....	20
4.6	Start testing. ....	20
4.7	Complete the test (Summary) .....	20
<b>5</b>	<b>Chapter 5 – Program and Operation</b>	
5.1	Main menu.....	21
5.2	Tree Menu List.....	22
5.2.1	Language Options .....	22
5.2.2	Display options .....	22
5.2.3	Control options.....	24
5.2.4	Diagnostic Options.....	25
5.2.5	Camera Options .....	26
5.2.6	Function Programming .....	27
<b>6</b>	<b>Chapter 6 – Direct Command entry (Short-cuts) &amp; Technical Specifications</b>	
6.1	Command reference table .....	29
6.2	Technical Specifications.....	29
<b>7</b>	<b>Chapter 7 – Trouble Shooting.....</b>	<b>30</b>
<b>8</b>	<b>Chapter 8 – Appendix – Glossary .....</b>	<b>32</b>

# 1. Introduction

The CDC2500 xxx Mini series High Speed domes and a series of compatible keyboard controllers make up the building blocks for any size video surveillance system. Using multiple keyboard controllers and multiple high speed dome camera units, one can monitor a variety of environments from small to very large. Extensive and flexible architecture facilitates remote control functions for a variety of external switching devices such as multiplexers and DVRs.

## 1.1 Performance Characteristics

- Built-in 18x (27x) times Optical power zoom camera with true day night capability.
- 0 ~ 255 individually addressed units. The dome address is defined using a dip switch with 8 positions (Binary addressing scheme)
- Integrated multi-protocol and auto protocol differentiation.  
Note: The dome can auto differentiate the protocol of the controller only on power up.
- Continuous Pan 360 degree rotation (slip ring).
- 90 degree Tilt action plus 2 degree angle adjustment (the view angle can be 90 or 92 degrees).
- Pan speed in manual operation is variable from 0.1 up to 300 degrees per second
- Tilt speed in manual operation is variable from 0.1 to 120 degrees per second
- 128 preset positions. (A preset position is defined as a user definable setting for precise coordinates , pan, tilt and zoom on all 3 axis)
- The maximum speed when a preset position is called can reach 400 degrees per second with positioning accuracy of  $\pm 0.1$  degree.
- Compatible with a variety Camera Modules (Sony, Hitachi, Sanyo, Yoke, CNB, LG, Samsung)
- Input power supply: 24 VAC - 1Amp (indoor model), 24 VAC - 2Amp (outdoor model)
- User friendly on screen menu interface for ease of installation.
- Environmental protection conforming to IP66 standards (outdoor model)
- RS-485 (long distance) communications mode.
- Selectable transmission speed, (i.e. Baud rate). User definable via dip switch settings from 2400bps~19200bps

## 1.2 Features and Functions

- Multi-language on screen menu for operation and function settings.
- On screen Camera title with exact x/y coordinates. (The camera title is user definable as well as the ability to display or not the camera coordinates)
- On screen Crosshair function (By enabling this option, the target can be followed more effectively using the crosshairs as a reference point).
- Three user definable PTZ tours with up to 2 minutes record duration for each tour. ( User has the ability in real-time to monitor and record the action of a manual dome operation) The 3 tours consisting of preset, pattern, and auto scan functions, can be programmed with a multitude of functions and preset locations. While moving, each preset scan can be watched in smooth vector scan mode.
- 5. Six group of programmable vector scans (including scan speed, dwell time, preset and dwell time between tours)
- Auto flip function with + 10 degree positioning
- Eight sectors of user programmable privacy zones (sectional mask). User can mask part of the camera sectors which differs between different models of installed cameras.
- Eight sectors of user programmable sectional display. User can define and display the name and position of the camera, which differs between different models of installed cameras.
- Resume automatic operation after initial self-test of the dome as well as resume automatic operation when there is no transmission from a keyboard controller. (Dwell time can be set from 1 to 999 seconds)
- Freeze frame function.
- Resume operation function. (Dome unit will return to the previous operation after the execution of an operation using the on screen menu)
- Intelligent manual scan function. ( By executing this function in manual pan operation, you can adjust the manual pan behavior of the dome )
- 13. Intelligent power off real time memory.( Should power fail while the dome was in operation , the dome will resume its preprogrammed function upon power restore)
- Highly efficient 3-dimensional scan function.
- Zoom and dome speed correlation function. (When the camera is zoomed in close, the dome speed is reduced to allow for precise operation control)



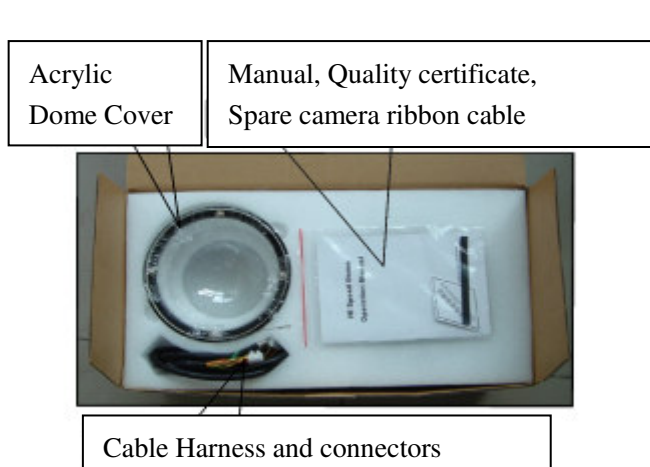
## 2.1 Package Contents

The dome carton contains the following:

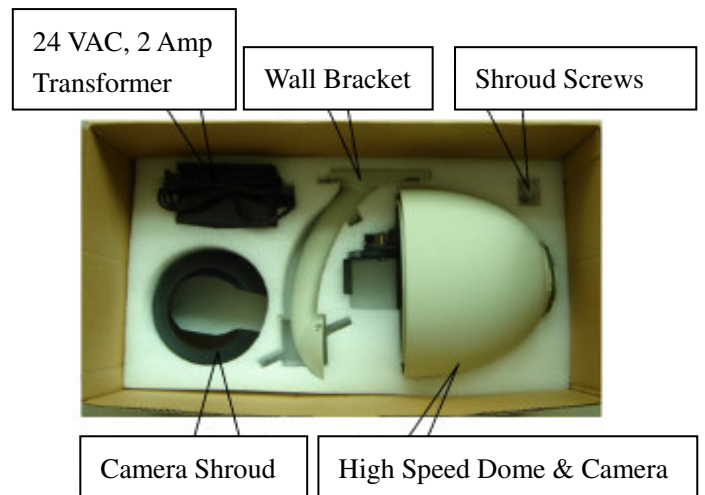
Description	Qty
High Speed Dome mechanism	1
Camera Module (Sony 18x or LG27x)	1
Clear Acrylic dome cover	1
Camera shroud (black)	1
Bag of Screws (4xM2*4, 4xM3*5)	1
8 conductor Control/Power/Video harness	1
24VAC transformer (optional)	1
Wall bracket (optional)	1
Instruction manual	1
Camera Ribbon cable (spare)	1

Figure 1. Illustrates the upper layer of the packing material (top half)

Figure 2. Illustrates the lower layer of the carton (bottom half).



**Fig.1**

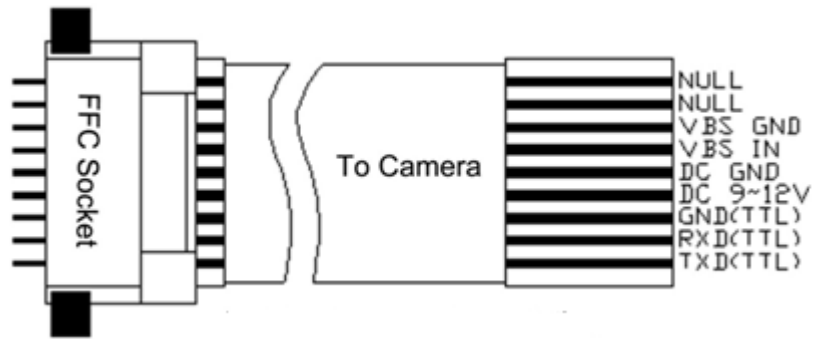


**Fig. 2**

## 2.2 Camera Installation (Optional)

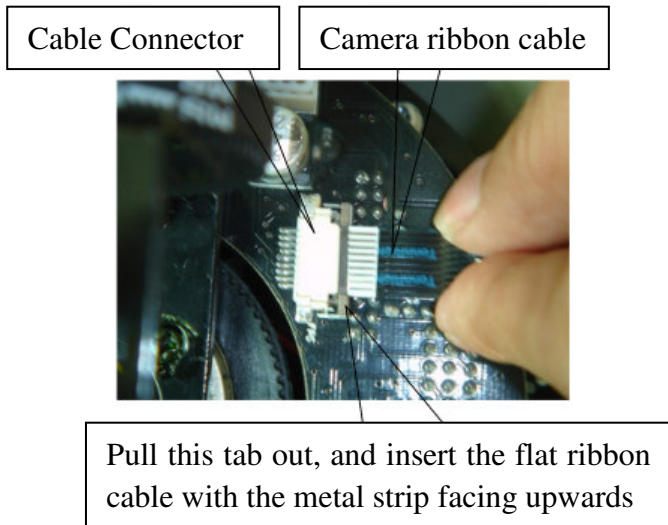
**NOTE:** The camera module is pre-installed and tested at the factory according to your order. You do not need to perform any of the following 3 steps unless you desire to change or upgrade the camera module.

The following instructions are for reference purposes only should you need to replace the cable that connects the camera module to the control board. Figure 3 below illustrates the wiring configuration of the flex ribbon/cable.

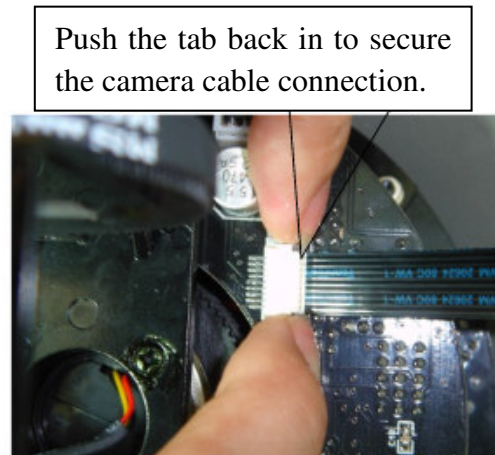


**Fig. 3**

**Step 1:** Insert FFC Socket of the cable to the relevant port of the base plate on the dome control board as illustrated in Figures 4 and 5.



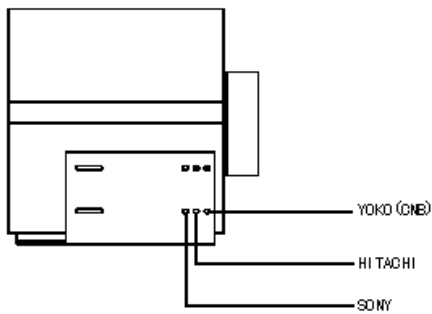
**Fig. 4**



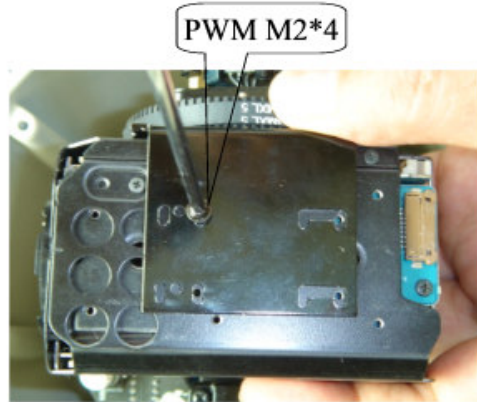
**Fig. 5**

**Step 2:** Install the block video camera module on the vertical axis tray of the dome as illustrated in Figure 7 using the (4) supplied M2\*4 screws.

**Attention:** Exercise care not to scratch the lens when installing the camera. (as a precaution leave the protective camera lens cap in place until ready to use the dome. Secure the camera to the corresponding screw holes as illustrated in Figure 6, according to the model and make of the camera, as different camera models may have different dimensions. Following the installation of the camera module verify that it does not touch any of the dome parts including the camera shroud and acrylic dome by gently moving the camera module along the vertical axis.



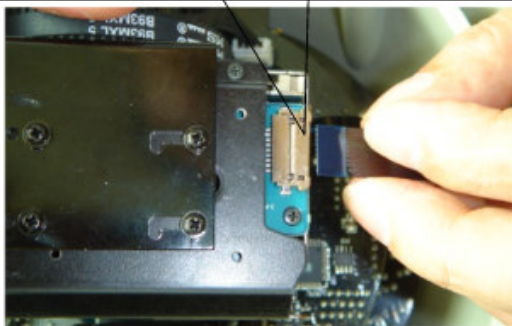
**Fig. 6**



**Fig.7**

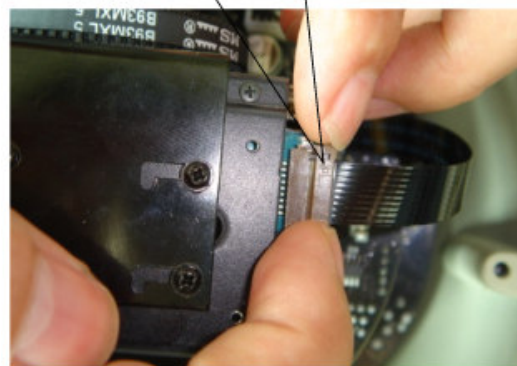
**Step 3:** Insert the other end of the ribbon cable to the corresponding camera connector as illustrated in Figures 8 and 9.

Pull this tab out and insert the ribbon cable



**Fig. 8**

Push the tab back in to secure the camera cable connection.

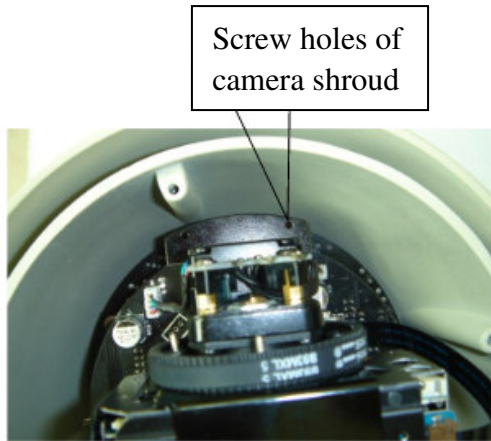


**Fig. 9**

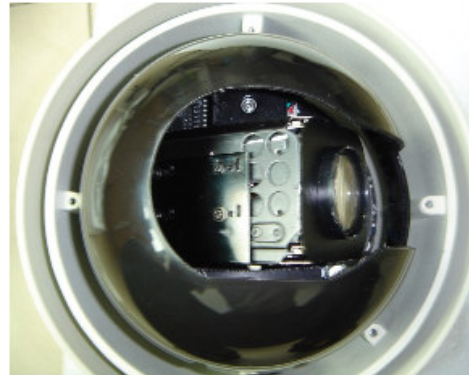
## 2.3 Camera Shroud installation.

Figure 10. Illustrates the location of the screw holes for the camera shroud. (4 x M3)

Figure 11. Illustrates the camera shroud in position over the camera module



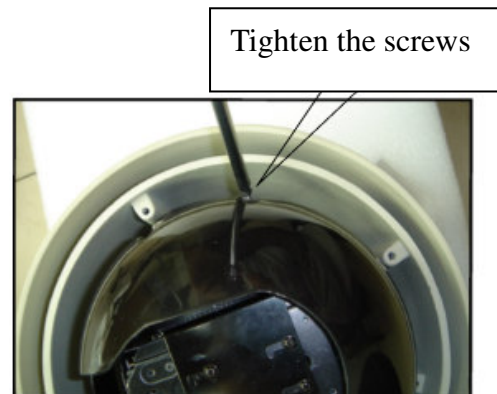
**Fig. 10**



**Fig. 11**

**Step 1:** Position the open end of the camera shroud towards the camera lens as illustrated on Figure 11. Align the 4 holes of the shroud with the 4 holes on the motor support of the dome as illustrated in Figure 12.

**Step 2:** Utilizing the supplied (4) four M3\*5 screws securely tighten the camera shroud in place, as illustrated in Figure 12.

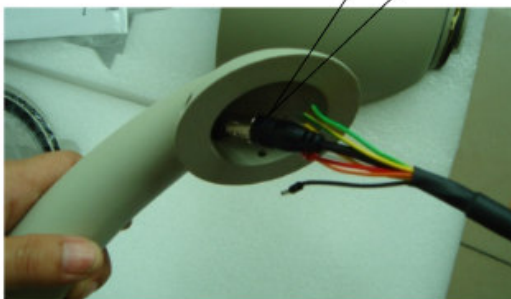


**Fig.12**

## 2.4 Wall bracket installation.

**Step 1:** Feed the supplied dome wiring harness through the channel inside the wall bracket as illustrated in Figure 13. Verify that the 8 pin connector is remaining outside the opening of the bracket.

Feed the cable through, BNC end first.



**Fig. 13**

**Step 2:** Affix the wall bracket to the wall verifying that the surface you are attaching to can support the weight of the dome using either expanding anchors or butterfly fasteners as illustrated in Figure 14.



Expanding fasteners

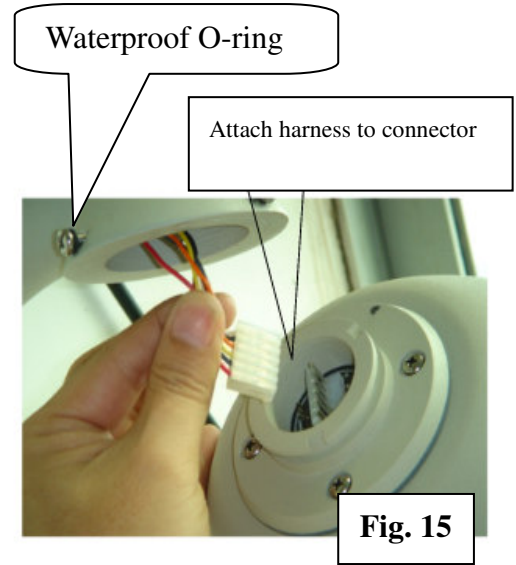
**Fig. 14**

**Note:** Different bracket options may be available. Illustrations are for reference purposes only and may vary from actual package contents depending selected installation options at time of order.

## 2.5 Attaching the dome to the bracket

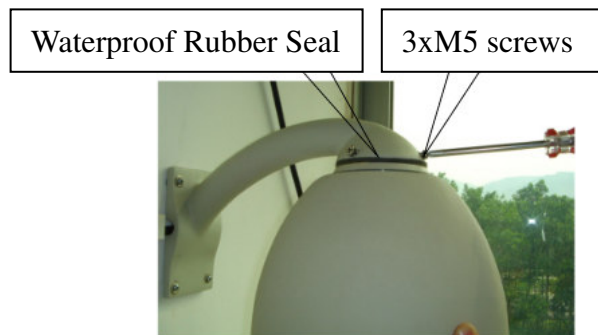
**Step 1:** Connect the end of the wiring harness protruding out of the bracket to the mating connector on the dome unit. Observe proper orientation of the connectors (tab facing towards the back of the connector), as illustrated in Figure 15.

**Step 2:** Position the dome upwards so that the top ring of the dome is flush with the bracket and secure it in place by tightening the screws as illustrated in Figure 15.



### Caution:

1. The screws that hold the dome to the bracket are equipped with o-ring seals. Please verify that they are in place and securely positioned as illustrated in Figure 15.
2. In between the bracket and the dome there is a weatherproofing seal made from a spongy material as illustrated in Figure 16. Make sure that it is firmly attached to the dome upper surface as it will prevent any water from entering into the dome electronics. In contrast with the outdoor model the seal for the indoor unit is made from silicon.



**Fig. 16**

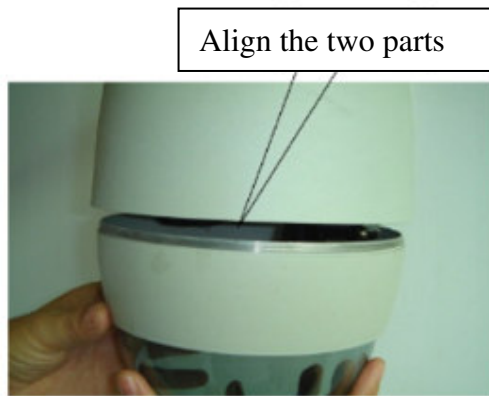
**Note:** Different bracket options may be available. Illustrations are for reference purposes only and may vary from actual package contents depending selected installation options at time of order.

## 2.6 Installation of the acrylic dome cover

The dome cover has two parts, a metal aluminum ring and a clear acrylic dome. The metal ring has male fine threads that will allow it to mate with the aluminum cover of the dome mechanism. **Caution** should be exercised when handling the clear dome preventing any abrasions or scratches to the surface as this will affect the optical performance of the camera.

**Step 1:** Carefully align the two parts as illustrated in Figure 17. Slowly rotate counterclockwise until a small click is felt indicating the beginning of the threads.

**Step 2:** Slowly start rotating the bottom part (clear acrylic) in a clockwise direction without forcing the threads as illustrated in Figure 18. It takes approximately three (3) complete rotations to have a complete seal.



**Fig. 17**



**Fig. 18**

**Step 2:** Remove the protection film as illustrated in Figure 19. Avoid direct contact with the acrylic if possible.



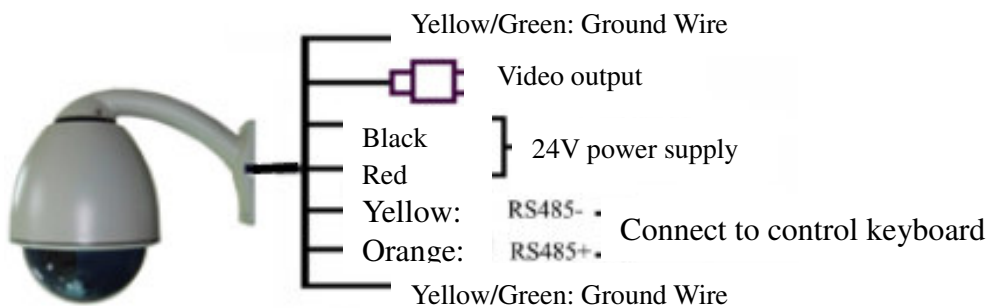
Protection film of acrylic shield

**Fig. 19**

## 2.7 Wiring Specifications

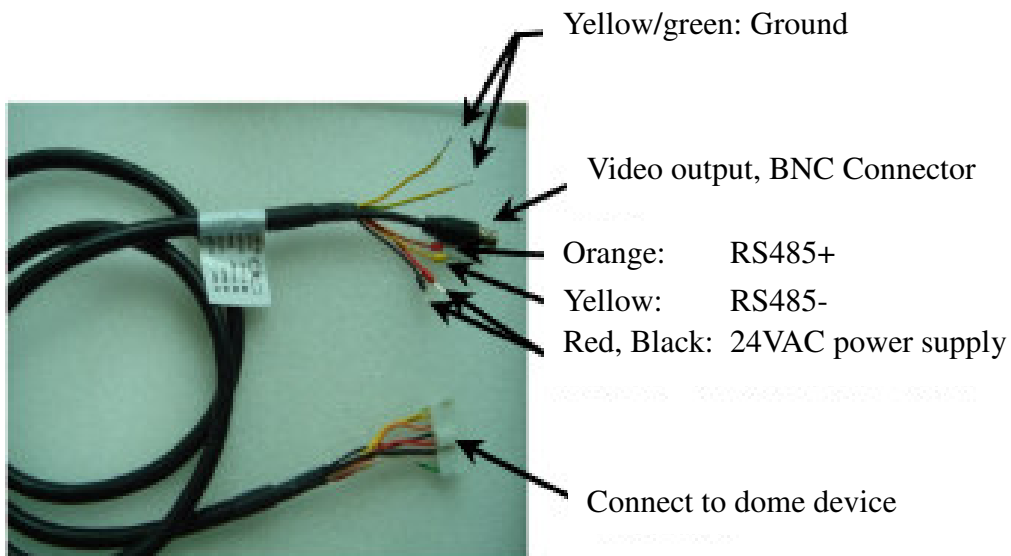
The wiring Harness has a label affixed indicating the Power, Video and Communication conductors. Do not remove this label as it may be a useful future reference.

Figure 20 is the illustration of the wiring diagram for the electrical connections to the dome unit.



**Fig. 20**

Figure 21 illustrates the wiring harness included with the dome.



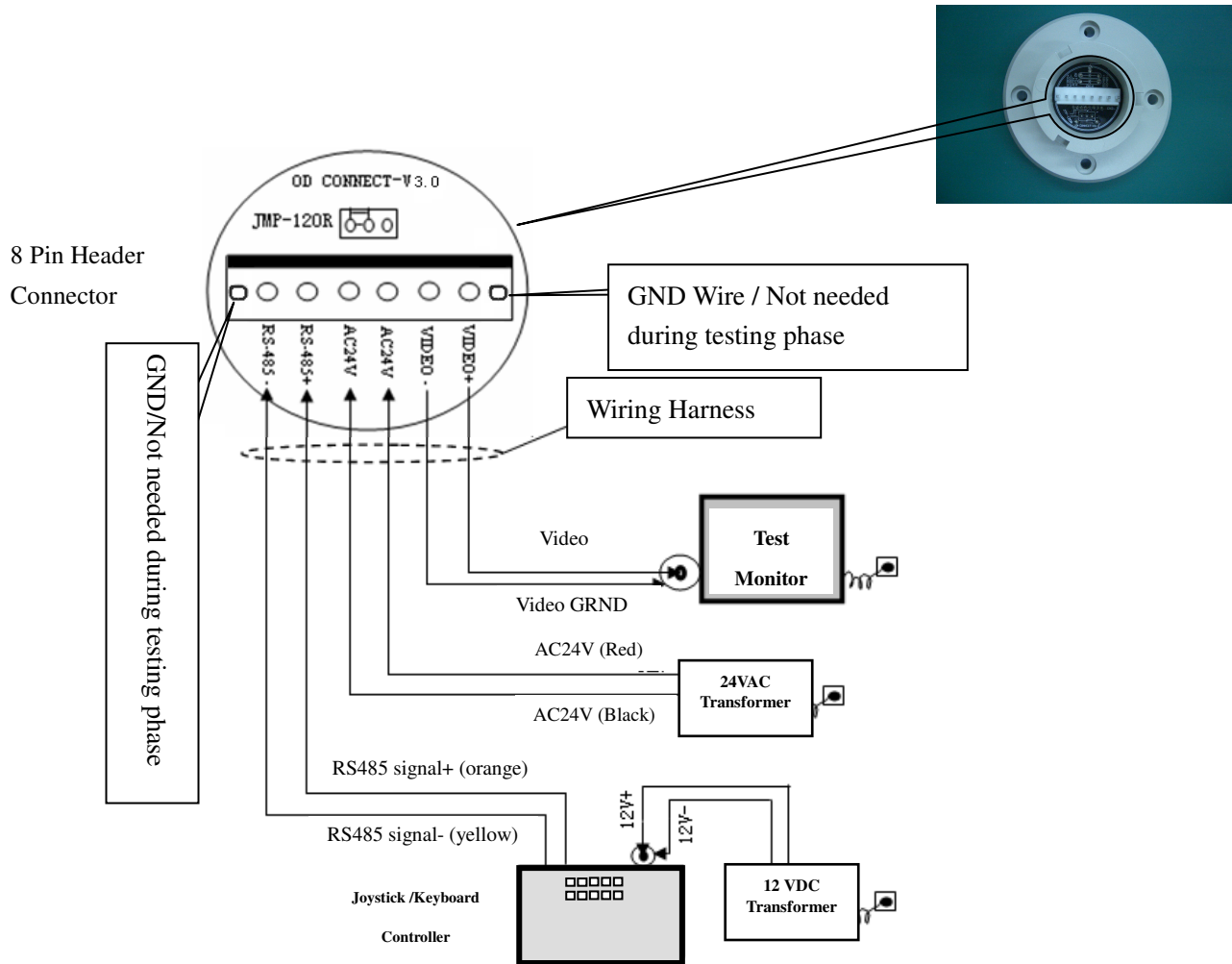
**Fig. 21**



# Chapter 3: Wiring and Setup

## 3.1 Basic Configuration

The illustration below provides the basic electrical wiring configuration for connecting and testing a single dome to a test monitor and a joystick / keyboard controller. When installing the product for the first times please read the installation instructions carefully and become familiar with the electrical connections and setup options. Incorrect wiring may result to permanent damage of the equipment.



In the above illustration, JMP-120R is the impedance matching selection of control signal and noise restrain of RS-485. When the dome control is done over long cable run or there is a need for noise limiting, you need to install this jumper (provided) together with the set of screws. For normal runs up to 500 feet no action is required.

**Caution: This operation should be performed with the power removed (Power OFF).**

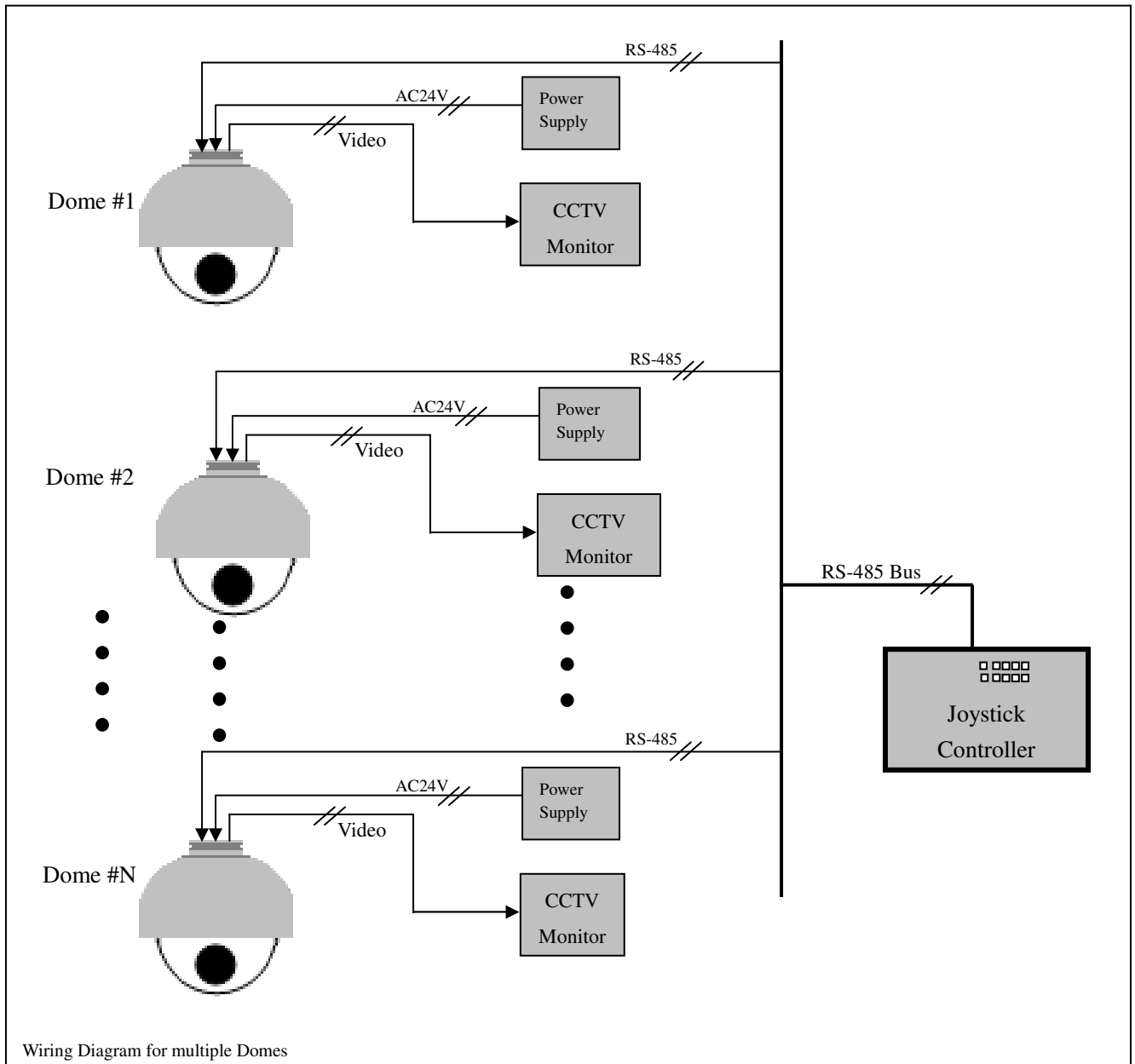
### 3.2 Connecting Multiple Domes

When connecting multiple domes together, the user has the option to connect video and control terminals to a video matrix switcher or a DVR multiplexer creating an integrated system.

**AC24V:** Power supply Primary 110V/60Hz input to AC 24V output.

**RS-485 Bus:** Control signal output from joystick controller, connected in a bus configuration to the RS485 communication terminals of the control cable for each dome.

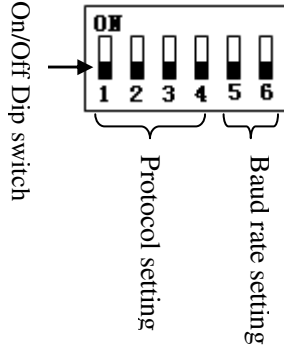
**Video:** Signal output from the dome camera connected to a monitor, DVR, or video matrix. Take into consideration impedance matching and or termination.



### 3.3 Communication Settings

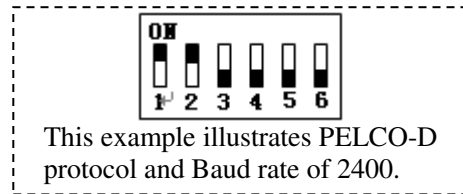
Before installation and use, the unique address for each dome and the communication protocol including transmission speed (baud rate) should be set to correspond with the chosen control system.

### 3.4 Setting the Protocol and baud rate settings for each dome device.



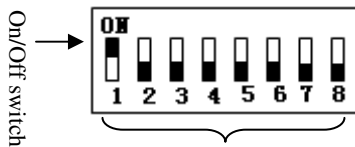
Baud rate \ On/Off	5 <sup>th</sup> digit	6 <sup>th</sup> digit
2400	OFF	OFF
4800	OFF	ON
9600	ON	OFF
19200	ON	ON

**CAUTION:** The protocol and baud rate of dome device should match the settings of the controller. In order to take effect the dome must be power cycled after each change.



On/Off status \ Protocol type	1 <sup>st</sup> digit	2 <sup>nd</sup> digit	3 <sup>rd</sup> digit	4 <sup>th</sup> digit	5 <sup>th</sup> digit	6 <sup>th</sup> digit
<b>PELCO-D</b>	ON	ON	OFF	OFF	**	**
<b>PELCO-P</b>	OFF	OFF	ON	OFF	**	**
<b>Auto Detect</b>	OFF	OFF	OFF	OFF	**	**
<b>System reserve</b>	ON	ON	ON	ON	**	**

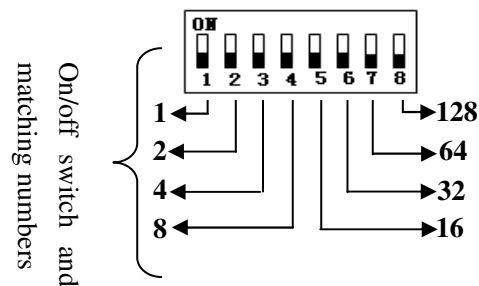
### 3.5 Address setting of each dome. To prevent damage, each dome must have a unique address (ID).



Setting address for dome device (this figure shows the address of dome device No 1).

Dome device range: 0~255.

**Setting method:** The sum of switch numbers in the ON position is the address of the dome device. (Binary Method)



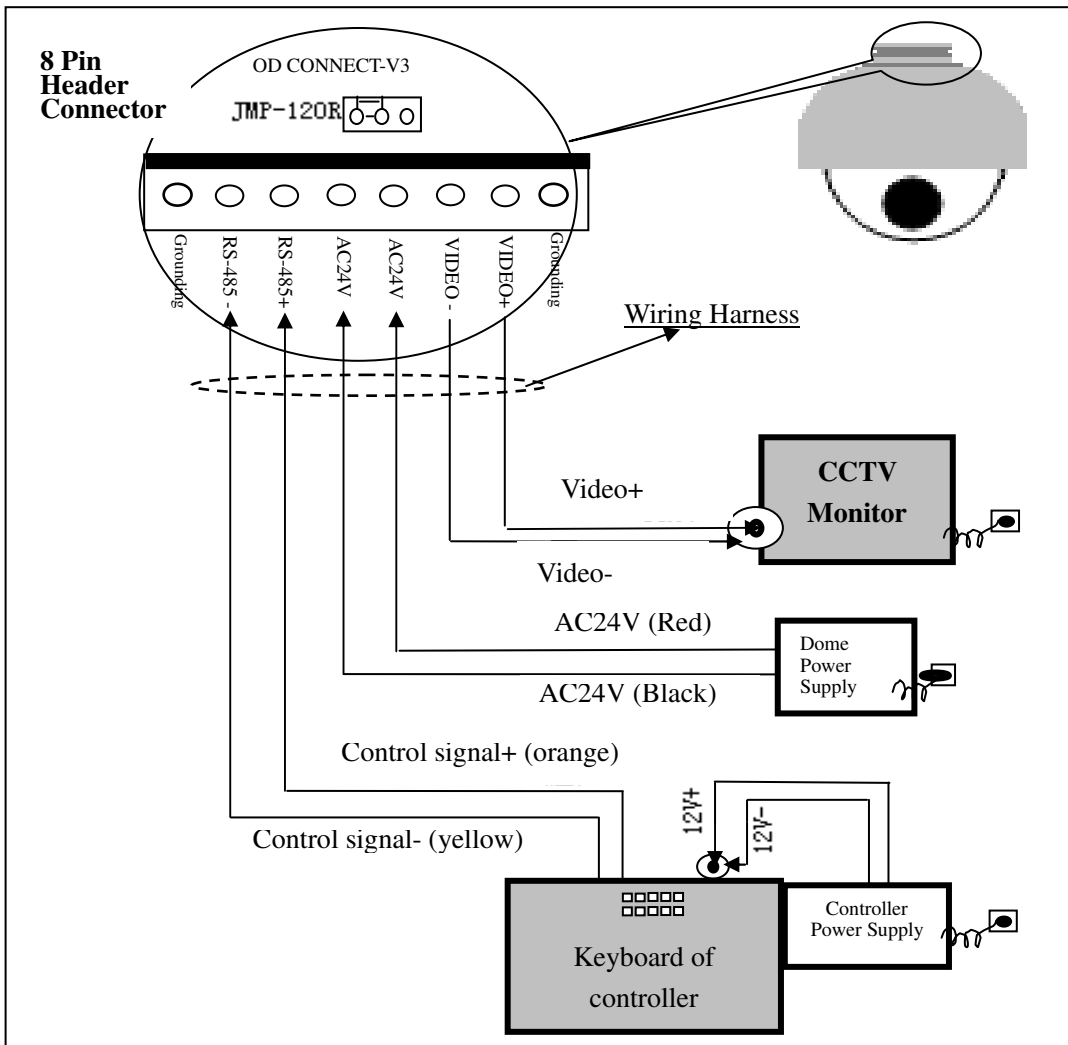
( 2+4+16=22 ) the dome address is: **22**

Calculation example of dome device address:

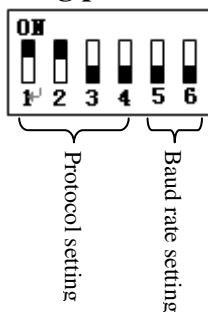
## 4. Quick Start Operation Guide

### 4.1 Wiring Instructions

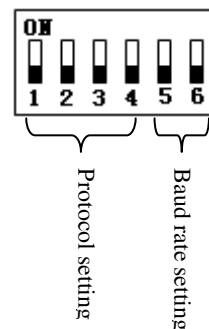
**CAUTION:** Do not turn the power ON until you have finished all connections and settings).



### 4.2 Setting protocol and baud rate. (Turn the power off when setting, and restart the device after revision).



This figure illustrates: Protocol: **PELCO-D**  
Baud rate: **2400 bps**



This figure illustrates: Auto detection protocol.  
Baud rate: **2400bps**

*Note: This dip switch is located on PCB in the control board just below the camera module*

### 4.3 Setting the device address. (Turn the power off when setting, and restart the device after revision).



The figure shows: Address of dome device: No. 1

Address Setting for dome

*Note: This dip switch is located on PCB in the control board just below the camera module*

### 4.4 Connect the power to the dome.

As soon as the power is turned ON, the dome initiates a self test which includes a rotation of the dome on both axis and the camera will display a brief menu followed by a live image on the monitor.

**Note:** During self-testing, it is normal to hear a clicking sound caused by the camera module for about 2~5 seconds of vertical movement, as a result of the vertical self alignment.

### 4.5 Joystick controller setting.

**Set the protocol, baud rate, and address of the keyboard controller to match the settings on the dome**

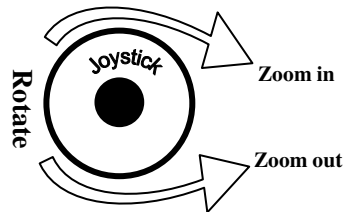
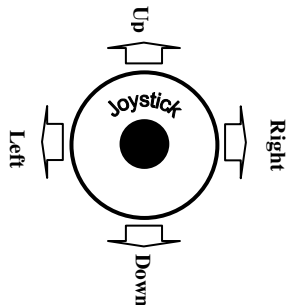
(For instructions of how to set the keyboard communication settings please refer to keyboard controller manual).

**Attention:** If the protocol setting of the dome is set to auto detection, the protocol of keyboard controller can be set arbitrarily. But its baud rate should be set identical with that of the dome device.

### 4.6 Start testing.

When all of the above settings are completed you can start testing to dome functionality.

1. Direction control test of dome device
2. Zooming control test of camera



The operation of the dome and the direction (up, down, left and right) of the camera can be controlled using the joystick of the keyboard controller, as illustrated above.

Zoom control of the camera can be achieved by rotating the knob on the joystick or by using TELE (zoom in) and WIDE (zoom out) functions on the keyboard controller as illustrated above.

( Please refer to the next section for demonstration of menu operation and control of dome device. )

### 4.7 Complete the test. (Summary).

If you have achieved control of the dome device as described in section 4.6 above, the system is basically normal.

Do not change the wiring or the applied settings. If the dome does not respond to the commands or only partial functionality is achieved, verify the wiring connections (section 4.1 and 4.4) and communication settings (sections 4.2, and 4.3) carefully.

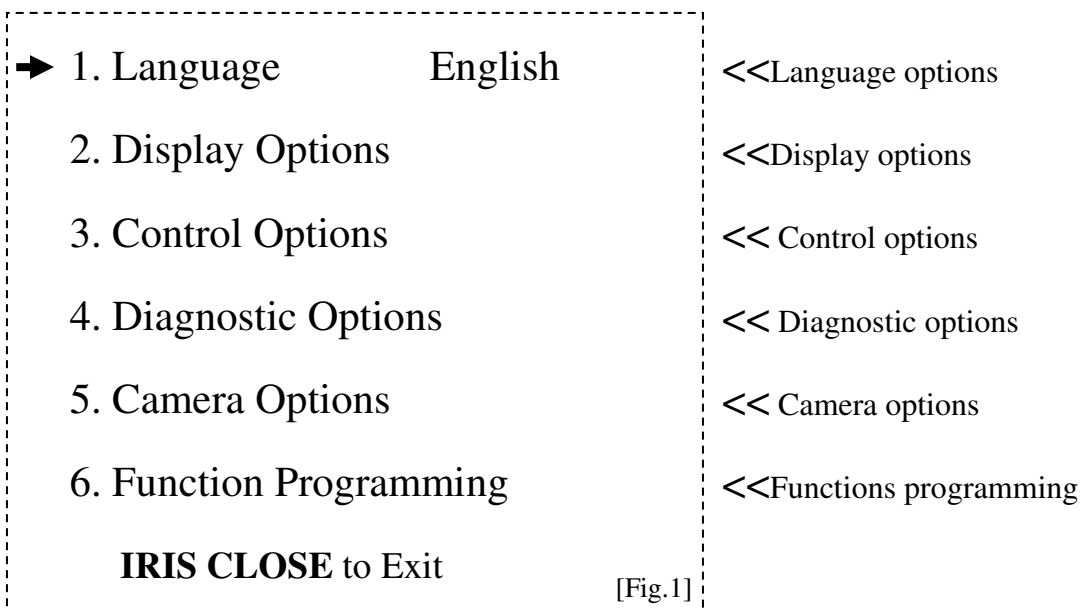
## 5 Program and Operation

### 5.1 Main menu

The following commands are references to the keyboard controlling the dome. Depending the make and model of the controller these commands may vary slightly. For reference purposes the following key labels / acronyms are used:

**SHOT = PRESET or PRST - ACK = ENTER - OPEN = Iris open - CLOSE = Iris Close**

1. Press **90+SHOT+ACK** on the keyboard to enter the main configuration menu for the dome. (Fig.1).
2. To make a selection move the joystick in the **Up or Down** direction. The on-screen arrow points to the selected option. Using the joystick to the **Left or Right** position you can change the value of your selection or enter the submenu for the selected option.
3. Press **CLOSE** (Iris Close) to exit menu or return to the previous menu (one layer up).



## 5.2 Tree Menu List.

1.All sub-menus can be seen clearly in this tree list.

5.2.1. **Language** English

<< Depending Country of sale different options available

5.2.2. **Display options**

<< Display options

1. **PreShot setup**

<< Preset position setup options

1. **Numder** 001

<< Preset number selection

```

1~165
001
↑
0 1 2 3 4 5 6 7 8 9
IRIS CLOSE When Done
  
```

<< The default number is 001. Move the joystick left or right to move the cursor under the desired numeral position and press **OPEN** to move the cursor on the second numeral line (0~9). Move the Joystick left or right again under the desired numeral position and press **OPEN** to select the desired number (0~9). Press **OPEN** again to confirm the selection.

<< Press **CLOSE** to finalize your selection and return to the previous menu level.

2. **Set Preshot**

<<Move the Dome camera to the desired position on all 3 axis (P,T,Z) and then press **CLOSE** to confirm the preset position location and return to the previous menu level.

```

IRIS CLOSE When Done
  
```

3. **Call Preshot**

<<Call preshot.

```

Call 001
  
```

Based on the displayed/selected preset position on line 1 of this menu, the dome will respond upon moving the joystick to the Right position and move to the corresponding coordinates of the selected preset position.

4. **Delete preshot**

<<Delete preshot.

```

Are you sure to do this?
IRIS OPEN to Confirm
IRIS CLOSE to Cancel
  
```

<<Caution: Are you sure you want to delete preset?

Press **OPEN** to confirm

Press **CLOSE** to exit and return to the previous menu level.

5. **Name** \_\_\_\_\_

<<Edit the name of a preset position.

```

↑
0 1 2 3 4 5 6 7 8 9 A B C D E F G H I J K L M N
O P Q R S T U V W X Y Z _
IRIS CLOSE When Done
  
```

<<Joystick Left or Right when programming to select preset and press **OPEN** to confirm.

Joystick Left or Right to select (0~~9 or A~~Z).

Press **OPEN** to confirm selection.

Press **CLOSE** to exit or return to the previous menu level when programming is done.

6. **Name Display** ON/OFF <<On Screen display On/Off **Joystick Left or Right to select**

IRIS CLOSE to Exit

## 2. Sector Setup

<< Sector setup **Press OPEN or Joy stick Left or Right to enter**

1. **Number** ( 1 ~ 9 )

<< Number selection **Joy stick Left or Right to select**

2. **Name** \_\_\_\_\_

<< Name editing **Press OPEN or Joy stick Left or Right to enter**



0 1 2 3 4 5 6 7 8 9 A B C D E F G H I J K L M N  
O P Q R S T U V W X Y Z \_  
**IRIS CLOSE When Done**

<< **Joystick Left or Right** when programming to select preshot and press **OPEN** to confirm. Joy stick left or right to select (0~9 or A~Z). Press **OPEN** to confirm selection. Press **CLOSE** to exit or return to the previous menu level when programming is done.

3. **Pan Start POS** 0.0

<<Setup pan start point. **Press OPEN or Joystick Left or Right to enter**

Capture the start point and press **CLOSE** to exit and return to previous menu.

IRIS CLOSE When Done

4. **Pan End POS** 0.0

<< Setup pan end point. **Press OPEN or Joystick Left or Right to enter**

Capture the end point and press **CLOSE** to exit and return to previous menu.

IRIS CLOSE When Done

5. **Tilt Start POS** 0.0

<< Setup tilt start point. **Press OPEN or Joystick Left or Right to enter**

Capture the start point and press **CLOSE** to exit and return to previous menu.

IRIS CLOSE When Done

6. **Tilt End POS** 0.0

<< Setup tilt end point. **Press OPEN or Joystick Left or Right to enter**

Capture the end point and press **CLOSE** to exit and return to previous menu.

IRIS CLOSE When Done

7. **Name Display** ON/OFF

<<Sector name display On/Off **Joystick Left or Right to select**

IRIS CLOSE to Exit

3. **Coordinates** ON/OFF

<<Coordinates display On/Off **Joystick Left or Right to select**

4. **Crosshairs** ON/OFF

<<Crosshairs On/Off **Joystick Left or Right to select**

5. **Start-UP Scr Msg** ON/OFF

<<Start-up screen message On/Off **Joystick Left or Right to select**

IRIS CLOSE to Exit



## 5.2.3. Control options

<<Control options **Press OPEN or Joystick Left or Right to enter**

### 1. Set Pan and Tilt <<Pan/Tilt setup of dome device **Press OPEN or Joystick Left or Right to enter**

- |                            |        |                       |        |   |
|----------------------------|--------|-----------------------|--------|---|
| 1. <b>Pan Reverse</b>      | ON/OFF | << Pan Reverse        | ON/OFF | <b>Joystick Left or Right to select</b> |
| 2. <b>Tilt Reverse</b>     | ON/OFF | << Tilt Reverse       | ON/OFF | <b>Joystick Left or Right to select</b> |
| 3. <b>+2 Tilt Limit</b>    | ON/OFF | <<+2 Tilt Limit       | ON/OFF | <b>Joystick Left or Right to select</b> |
| 4. <b>Find Home On STA</b> | ON/OFF | << Find Home on start | ON/OFF | <b>Joystick Left or Right to select</b> |

IRIS CLOSE to Exit

### 2. Set Default Function <<Set default function **Press OPEN or Joystick Left or Right to enter**

#### 1. **Default Function P/V/T** <<Select (Preshot/Tour/PTZ) **Press OPEN or Joystick Left or Right to enter**

#### 2. **Number** 1 << Function number selection **Press OPEN or Joystick Left or Right to enter**

```

1~128
001
↑
0 1 2 3 4 5 6 7 8 9
IRIS CLOSE When Done
    
```

<< Joystick left or right when programming to select preshot and press **OPEN** to confirm.

Joystick left or right to select (0~~9). Press **OPEN** to confirm selection.

Press **CLOSE** to exit or return to previous level menu when programming is done.

#### 3. **Delay** 001 <<Time delay setting (second) **Press OPEN or Joystick Left or Right to enter**

```

1~999
001
↑
0 1 2 3 4 5 6 7 8 9
IRIS CLOSE When Done
    
```

<< Joy stick left or right when programming to select preshot and press **OPEN** to confirm.

Joy stick left or right to select (0~~9). Press **OPEN** to confirm selection.

Press **CLOSE** to exit or return to previous level menu when programming is done.

#### 4. **Operation** ON/OFF <<Default function On/Off **Joystick Left or Right to select**

IRIS CLOSE to Exit

### 3. **Speed Limit** ON/OFF <<Operation speed limit On/Off **Joystick Left or Right to select**

### 4. **Auto Flip** ON/OFF <<Auto flip On/Off **Joystick Left or Right to select**

### 5. **Auto Focus** PTZ/OFF/Z <<Auto focus options **Joystick Left or Right to select**

### 6. **Auto AE** PTZ/OFF/Z <<Auto AE option **Joystick Left or Right to select**

### 7. **Vector Scan AF** ON/OFF <<Vector scan auto focus control **Joystick Left or Right to select**

IRIS CLOSE to Exit

## 5.2.4. Diagnostic Options

### 1. Clear Memory

```

-----
Are you sure to do this?
IRIS OPEN to Confirm
IRIS CLOSE to Cancel
-----

```

<< Diagnostic options **Press OPEN or Joystick Left or Right to enter**

<< Clear data **Press OPEN or Joystick Left or Right to enter**

<< Reminder: are you sure to do this.

Press OPEN to confirm.

Press **CLOSE** to exit and return to upper stage menu.

### 2. Restore Def. Setting

```

-----
Are you sure to do this?
IRIS OPEN to Confirm
IRIS CLOSE to Cancel
-----

```

<< Restore default settings **Press OPEN or Joystick Left or Right to enter**

<< Reminder: are you sure to do this.

Press OPEN to confirm.

Press **CLOSE** to exit and return to upper stage menu.

### 3. Color system PAL/NTSC

<< PAL/NTSC switch **Joystick Left or Right to select**

### 4. Scan & Camera Reset(Null)

<<Restart dome camera. **Press OPEN or Joystick Left or Right to enter**

### 5. Dome Information

```

-----FuGa6-----
Camera: x x x x x x x x
Protocol: x x x x x x x x
Baud rate: x x x x
Dome No.: x x x
IRIS CLOSE to Exit
-----

```

<<Dome information. **Press OPEN or Joystick Left or Right to enter**

<<Name of dome

<<Type of camera

<<Control protocol

<<Baud rate

<<Dome number

<< Press **CLOSE** to exit and return to previous menu.

## 5.2.5. Camera Options

<< Camera options **Press OPEN or Joystick Left or Right to enter**

### 1. Zoom and Focus

<< Zoom and focus setting **Press OPEN or Joystick Left or Right to enter**

1. **Zoom Speed** (0~8)

<<Zoom speed setting. **Joystick Left or Right to select**

2. **Digital Zoom** ON/OFF

<<Digital zoom in On/Off **Joystick Left or Right to select**

3. **AF Sensitivity** High/Low

<<Auto focus sensitivity setting. High/Low **Joystick Left or Right to select**

```

-----
IRIS CLOSE to Exit
-----

```

### 2. Auto Exposure

<< Auto exposure setting. **Press OPEN or Joystick Left or Right to enter**

1. **AE Mode** Auto/Manual/Shutter/Iris

<<Auto exposure mode. **Joystick Left or Right to select**

2. **Shutter Speed** xx

<<Shutter speed setting. **Joystick Left or Right to select**

3. **Iris** Fxx

<<Iris setting. **Joystick Left or Right to select**

4. **Gain** x

<<Gain setting. **Joystick Left or Right to select**

```

-----
IRIS CLOSE to Exit
-----

```

**3. Camera Name** <<Camera name setting **Press OPEN or Joystick Left or Right to enter**

**1. Name** \_\_\_\_\_ <<Edit camera name **Press OPEN or Joystick left or right to enter**

↑

0 1 2 3 4 5 6 7 8 9 A B C D E F G H I J K L M N  
 O P Q R S T U V W X Y Z \_  
 IRIS CLOSE When Done

<< Joy stick left or right when programming to select preshot and press **OPEN** to confirm. Joy stick left or right to select (0~~9 or A~~Z). Press **OPEN** to confirm selection. Press **CLOSE** to exit or return to upper stage menu when programming is done.

**2. Change Name Loc** <<Change display location of name **Press OPEN or Joystick Left or Right to enter**

IRIS CLOSE to Exit

<<Move Joystick arbitrarily and the display will be changed on the screen.

**3. Name Display** ON/OFF <<Name display On/Off **Joystick Left or Right to select**

IRIS CLOSE to Exit

**4. Mask Setting** << Mask sector setting **Press OPEN or Joystick Left or Right to enter**

**1. Number** ( 1 ~ 8 ) << Mask sector number selection. **Joystick Left or Right to select**

**2. Mask Edit** << Mask editing **Press OPEN or Joystick Left or Right to enter**

IRIS CLOSE When Done

<<Capture the masking point, press CLOSE to confirm. The system will auto exit and return to upper stage menu.

**3. Mask Display** ON/OFF << Mask Display ON/OFF **Joystick Left or Right to select**

IRIS CLOSE to Exit

**5. WB Mode** Auto/Manual <<White balance mode options **Press OPEN or Joystick Left or Right to enter**

**6. Back Light** ON/OFF <<Back light On/Off **Joystick Left or Right to select**

**7. Picture Flip** ON/OFF <<Picture flip On/Off **Joystick Left or Right to select**

**8. Picture LR Rev** ON/OFF <<Picture left and right reverse **Joystick Left or Right to select**

**9. Picture Stable** ON/OFF <<Picture stabilized On/Off **Joystick Left or Right to select**

**10. Day/Night** ON/OFF <<Black/white and color switch On/Off **Joystick Left or Right to select**

**11. F-OSD** ON/OFF <<Camera function display On/Off **Joystick Left or Right to select**

IRIS CLOSE to Exit

## 5.2.6. Function Programming

<< Special function **Press OPEN or Joystick Left or Right to enter**

### 1. PTZ Tour (Pattern)

<< Tour programming **Press OPEN or Joystick Left or Right to enter**

1. **Number** ( 1 ~ 3 )

<< PTZ tour number **Joystick Left or Right to select**

2. **Name** \_\_\_\_\_

<< Edit PTZ name **Press OPEN or Joystick Left or Right to enter**

```

↑
0 1 2 3 4 5 6 7 8 9 A B C D E F G H I J K L M N
O P Q R S T U V W X Y Z _
IRIS CLOSE When Done
  
```

<< Joystick left or right when programming to select preshot and press **OPEN** to confirm. Joystick left or right to select (0~~9 or A~~Z). Press **OPEN** to confirm selection. Press **CLOSE** to exit or return to previous level menu when programming is done.

### 3. Program a Tour

<<Enter Tour programming **Press OPEN or Joystick Left or Right to enter**

```

IRIS OPEN to Begin
IRIS CLOSE to Exit
  
```

<<Press OPEN to confirm and start programming.

<<Press CLOSE to exit the programming and return to upper stage menu.

### 4. Run a Tour

<<Run (pattern) **Press OPEN or Joystick Left or Right to enter**

```

Call out
  
```

### 5. Delete a Tour

<<Delete PTZ tour. **Press OPEN or Joystick Left or Right to enter**

```

Are you sure to do this?
IRIS OPEN to Confirm
IRIS CLOSE to Cancel
  
```

<< Reminder: are you sure to do this.Press OPEN to confirm.

Press **CLOSE** to exit and return to upper stage menu.

6. **Name Display** ON/OFF

<<PTZ tour name display On/Off **Joystick Left or Right to select**

**IRIS CLOSE to Exit**

## 2. Program Vector Scan

<< Program vector scan. **Press OPEN or Joystick Left or Right to enter**

1. **Number** ( 1 ~ 6 )

<<Vector scan number **Joystick Left or Right to select**

2. **Program a Vector scan**

<<Vector scan programming **Press OPEN or Joystick Left or Right to enter**

```

Name      Num      V      Dwell
1  → _      -      -      -
2      -      -      -      -
3      -      -      -      -
:
16
IRIS CLOSE When Done
  
```

<<Joystick arbitrarily to move the cursor, and stop the cursor at place of programming. Press **OPEN** to enter the selection.

**Function Name** → P/T/V

<<Press OPEN continuously to select  
P: Preshot, T: self-learn, V: vector scan

**Function Number** →  
1~128  
001  
↑  
0 1 2 3 4 5 6 7 8 9  
IRIS CLOSE When Done

<< **Joy stick Left or Right when programming** to select preshot and press **OPEN** to confirm.  
**Joy stick Left or Right to select** (0~9). Press **OPEN** to confirm selection.  
Press **CLOSE** to exit or return to upper stage

Velocity selection  
**V** → 1~9

<< Press OPEN continuously to select

Dwell time  
**Dwell** →  
1~99  
001  
↑  
0 1 2 3 4 5 6 7 8 9  
IRIS CLOSE When Done

<< **Joy stick Left or Right when programming** to select preshot and press **OPEN** to confirm.  
**Joy stick Left or Right to select** (0~9). Press **OPEN** to confirm selection.  
Press **CLOSE** to exit or return to previous level menu when programming is done.

**3. Run a Vector Scan**

<< Run vector scan. **Press OPEN or Joystick Left or Right to enter**

Call out

**4. Delete a Vector Scan**

<< Delete vector scan **Press OPEN or Joystick Left or Right to enter**

Are you sure to do this?  
IRIS OPEN to Confirm  
IRIS CLOSE to Cancel

<< Reminder: are you sure to do this.  
Press OPEN to confirm.  
Press **CLOSE** to exit and return to upper stage

**IRIS CLOSE to Exit**

**3. Program Alarms (NA)**

<<Program alarms. **Press OPEN or Joystick Left or Right to enter**

Note: Must have alarm board installed for this option, please consult with your supplier.

Name	Num	E/N
1	-	-
2	-	-
3	-	-
4	-	-

IRIS CLOSE to Exit

Name → P/V/T

Num →  
1~128  
0  
↑  
0 1 2 3 4 5 6 7 8 9  
IRIS CLOSE When Done

E/N → N/Y

## 6. Direct command entry (Short-cuts) & Technical Specifications

### 6.1 . Command Reference table

<b>System Preset Operation Table</b>	
80 + SHOT + ACK	Run PTZ Tour 1
81 + SHOT + ACK	Run PTZ Tour 2
82 + SHOT + ACK	Run PTZ Tour 3
83 + SHOT + ACK	Start Vector Scan 1
84 + SHOT + ACK	Start Vector Scan 2
85 + SHOT + ACK	Start Vector Scan 3
86 + SHOT + ACK	Start Vector Scan 4
87 + SHOT + ACK	Start Vector Scan 5
88 + SHOT + ACK	Start Vector Scan 6
89 + SHOT + ACK	Joy sticks between freeze and unfreeze video
90 + SHOT + ACK	Setup the Menus and Camera
91 + SHOT + ACK	Invokes the Flashback Function
PreShot 92 93 94	Reserve for future options

### 6.2 . Technical Specifications

Specifications	Power	24VAC – 1.0 Amp for indoor 2.0 Amp for outdoor
	Power Consumption	18W (without camera)
	Weight	6.5 lbs ~ 3Kg (without camera)
	Installation Method	Wall, Ceiling or Pendant brackets and Corner or Pole adapters
	Relative Humidity	10-75% ( non condensing )
	Operating Temperature	-4 <sup>0</sup> F to +120 <sup>0</sup> F or - 2 0°C to 5 0°C ( normal range )

## 7. Trouble Shooting

	<b>Problem Description</b>	<b>Possible Reason</b>	<b>Troubleshooting</b>	<b>Remarks</b>
<b>1</b>	After power is applied, there is no motion (self test) and no video image.	Cable harness is improperly connected or no AC power	Verify that the orientation of the connector and the power supply input	Please follow the supplied basic system wiring instructions to assure proper operation of dome device.
		Power PCB inside the dome is faulted.	Change the power PCB	
		Slip ring power wires disconnected or damaged	Verify connector or Change slip ring	
		Fault of main control board	Change main control board	
<b>2</b>	After power on, the dome device initiates self test but no video image or on screen characters displayed	OSD Character function is turned Off	Turn On the OSD display according to the instructions in the manual	Video will be displayed on the monitor automatically after 45 seconds from power On
		Incorrect Video connection between camera and control board or cable harness is damaged	Replace the FFC ribbon cable (spare supplied) or the camera module	
<b>3</b>	After self-test of the dome device, OSD menu is not displayed	Incorrect command sequence	Enter 90 + SHOT + ACK to display	After self-test, the menu can be displayed only when there is Video image on the monitor
		Fault of OSD control board	Replace OSD board	
<b>4</b>	Distorted Characters or video image	Interference caused by external electronic signals (noise) or the camera video format is set incorrectly (NTSC/PAL)	Ground the dome device or identify and reduce the external interference (electric motors, HF, high power fluorescent lamps) or reposition the camera to a different location	You should use properly shielded video cables.
		Internal System Error	Power cycle the dome.	
<b>5</b>	After power On, no self-test and motor is locked	Obstruction of the motor controls or incorrect cable connection	Verify that there are no obstructions and that the cable is connected correctly. If this does not solve the issue return the unit for service.	Follow installation instructions
<b>6</b>	Cannot stop pan rotation (rotate and stop alternatively)	OSD board is not properly connected with main control board.	Secure OSD board against the main control board. If the problem still exists, then replace the OSD board.	Rotational tab should be aligned in the center of the photoelectric switch (slot) for proper operation.
		Pan interrupt switch is not properly aligned or photoelectric switch is broken	Adjust the tab to be aligned with the photo electric switch or replace the switch assembly.	

## Trouble Shooting (Cont'd)

7	Following normal operation, dome will rotate one revolution while being controlled	The system could not verify the start position and initiates a self calibration.	This is a normal self calibration event. No action required.	If this happens frequently, verify the tab alignment with the photoelectric switch
---	--	--	---	--

8	Vertical range is not within $90\pm 2$ degree with large deviation	Fault occurs when the dome device is in tilt movement. It may be caused by obstruction of camera which leads to early tilt movement	Check and adjust the mechanical installation and remove any obstructions from the camera vertical platform.	
9	Self-test is normal, but cannot control dome	Wrong communication settings	Set the correct protocol, baud rate and address of dome device	Follow installation instructions
		Improper connection of control cable (polarity)	Verify the polarity of the RS485 connection as per the instruction manual	
10	Intermittent control of dome device	Maximum Communication cable run is exceeded	Add amplification circuit for RS485	This situation may occur following intense electric storms or severe lightning.
		Intermittent or incorrect connections	Verify the wiring	
		Slip ring is damaged	Replace the slip ring	
		RS-485 protective discharge arresters are damaged	Replace RS485 protective discharge arresters (qualified service only)	
11	Call out function fails	System failure caused by noise interference	Restart the dome device	
12	Dome operates by itself occasionally	No transmission auto "call back" function is set to the dome device	Verify this setting	
13	One dome works well while other do not under identical operation	Incorrect communication settings or wiring	Verify the communication setting and wiring again	Follow installation instructions



## **8. Appendix — Glossary**

### **AREAS**

Programmed start and end points of the dome's field of view around its pan axis.

Each area is a part of a circular viewing area that extends around the dome. The areas can be different sizes.

### **AUTOMATIC GAIN CONTROL (AGC)**

Allows for the amplification of the video signal in scenes with minimal ambient light. Many low-light scenes result in picture noise. As gain is increased, the picture noise is also amplified. When AGC is enabled, the value of the gain setting is based on feedback from the camera. When AGC is disabled, the camera uses the value set for the manual gain setting. The trade-off between picture level and noise may be adjusted when AGC is disabled.

### **ON-SCREEN MENU**

The text overlay menu system used for setting dome features. The utility is accessed using a keystroke combination. The utility provides settings for camera functions, zoom, alarms, text display, and password protection.

### **FLIP**

Allows the dome to automatically turn 180 degrees when the camera tilts to its lower limit and stays in that position for a brief delay. When the dome flips (rotates), the camera starts moving upward as long as the tilt control is kept in the down position. Once the control is released, the tilt control returns to its normal operational mode. The flip feature is useful when you need to track someone who walks directly beneath the dome and continues on the other side.

### **IR MODE**

A feature of the camera that permits manual or automatic switching between color and IR (black-and-white) operation. When IR mode is active, clearer images may be obtained under low-light conditions.

### **LINE LOCK**

Allows you to phase lock the video with the AC power line. When line lock is enabled, it prevents vertical video rolling when switching multiple cameras to a single monitor. If text appears slightly tinted on color monitors, disabling the line lock may prevent this problem.

### **NAME INFORMATION**

Relates to the display the dome name, the area where the dome is pointing, the name of the preset or pattern that is running, and alarm names. The display of each type of name setting can be enabled or disabled. When the display of camera or area title(name) is enabled, the information appears on the screen continuously. Preset, tour and pattern titles(names) appear only while they are active.

### **LOW SHUTTER**

Setting used to improve the quality of video obtained in extreme low-light situations. When the Low Shutter setting is enabled, low-light information is collected over multiple fields based on the Shutter Limit setting. As a result, video may appear blurred or choppy in extreme low-light situations. This setting does not effect camera operation in normal lighting situations. See also Automatic Gain Control (AGC).

**PATTERN**

A series of pan, tilt, zoom and focus movements from a single programmable dome. Up to 6 patterns may be programmed for the dome camera.

**PRESET - PRESHOT**

Programmed video scene, based on a specific pan, tilt, zoom, and focus settings. Up to 128 presets may be programmed for the dome camera.

**PRIVACY ZONES**

Masked areas of the dome camera's viewing area. These masks prevent operators of the surveillance system from viewing these designated zones. The Privacy Zones move in relation to the dome camera's pan/tilt position. In addition, the apparent size of the Privacy Zone adjusts automatically as the lens zooms in or out. Up to 6 Privacy Zones may be established for a dome camera.

**SHUTTER LIMIT**

Setting used to define the maximum exposure time for the Open Shutter setting. The values for the setting range from 1/2 to 1/60. The default setting is 1/4.

**VECTOR SCAN**

Move from start point to end point including tilt and zoom simultaneously and linearly.

**WDR**

Wide Dynamic Range Technology uses two shutter speeds in alternative video fields-high and normal- every 60th (or 50th) of a second and combines two fields into one progressive scan frame. It allows every detail to be captured accurately even if one portion of an image is brilliantly. Whether at the high shutter speed or normal shutter speed, the progressive scan CCD provides a horizontal resolution of 470 lines. As a result, combined fields yield a frame of high-quality images.

**WHITE BALANCE**

Adjustments in the color hue(red and blue) gains for a camera so that true white appears white in the image. It is normally compensated for by the automatic gain control. In some lighting conditions, you may need to manually adjust the red and blue settings for optimal viewing. When Automatic White Balance is enabled, the camera measures the image and automatically adjusts the red and blue settings to balance white. When Automatic White Balance is disabled, the camera uses the values set for the red and blue settings to balance white.

Note: Specifications subject to change without notice. All rights reserved.

