



**Altec Lansing inMotion Max Portable Speaker
for iPhone™ and iPod®
iMT702
User Guide**

Welcome

Thank you for purchasing the Altec Lansing inMotion Max speaker system. Designed specifically to work with your iPhone and iPod, this system provides high-quality audio and radio performance that brings out the best in your music.

This Altec Lansing speaker system is designed to work with:

- iPhone 3G
- iPhone
- iPod touch
- iPod nano (3rd generation)
- iPod classic
- iPod nano (2nd generation)
- iPod with video
- iPod nano (1st generation)
- iPod with color display
- iPod mini

Please carefully read this User Guide for instructions on setting up and using your inMotion Max speaker system.

Prior to installing or operating the Altec Lansing inMotion Max speaker system, refer to the important product safety information.

Getting Assistance

The answers to most setup and performance questions can be found in the Troubleshooting section of this guide. You can also consult the frequently asked questions (FAQ) in the customer support section of our Web site at www.alteclansing.com.

If you live in North America and still can't find the information you need, please call our customer service team for assistance before returning this product to your retailer under their return policy.

Tel: 800-258-3288 (Toll Free in US and Canada)

Email: csupport@alteclansing.com

If you live outside of North America, please visit our Web site at www.alteclansing.com and select your region to locate your country's distributor.

For the most up-to-date information, be sure to check our Web site at www.alteclansing.com.

International Distribution

International customers: For information regarding the distribution of Altec Lansing products in your country, please visit www.alteclansing.com and click on your region.

Registering Your Product

Visit www.alteclansing.com to register your product online, so we can provide you with the best possible service and technical support.

FCC Compliance

Changes or modifications not expressly approved by the party responsible for compliance could void the user's authority to operate this equipment.

This device complies with Part 15 of the FCC Rules. Operation is subject to the following two conditions:

- 1) This device may not cause harmful interference, and
- 2) This device must accept any interference received, including interference that may cause undesired operation.

Safety Information



The lightning flash with arrowhead, within an equilateral triangle, is intended to alert the user to the presence of un-insulated "dangerous voltage" within the product's enclosure that may be of sufficient magnitude to constitute a risk of electric shock to persons.



Caution: To prevent the risk of electric shock, do not remove cover (or back). No user-serviceable parts inside. Refer servicing to qualified service personnel.



The exclamation point within an equilateral triangle is intended to alert the user to the presence of important operating and maintenance (servicing) instructions in the literature accompanying the appliance.

RECHARGEABLE BATTERY

CAUTION: Danger of explosion if battery is incorrectly replaced. Replace only with the same or equivalent type. Do not expose to excessive heat such as sunshine, fire, or the like.

The battery used in this product must be properly recycled or disposed of. Instructions for removing the battery can be found in the *Getting Started* section. Please contact your local recycling center for proper battery handling and disposal instructions.

Rated voltage: 3.7V Capacity: 1800mAh Type: LC18650

CAUTION

To prevent electric shock do not use this (polarized) plug with an extension cord, receptacle or other outlet unless the blades can be fully inserted to prevent blade exposure.

WARNING

To reduce the risk of fire or electric shock, do not expose this appliance to rain or moisture.

IMPORTANT SAFETY INSTRUCTIONS

1. Read these instructions.
2. Keep these instructions.
3. Heed all warnings.
4. Follow all instructions.
5. Do not use this apparatus near water – This apparatus shall not be exposed to dripping or splashing, and no objects filled with liquids, such as vases, shall be placed on the apparatus.
6. Clean only with dry cloth.
7. Do not block any ventilation openings. Install in accordance with the manufacturer's instructions. The apparatus should not be situated on a bed, sofa, rug or similar surface that may block the ventilation openings. The apparatus must not be placed in a built-in installation, such as a closed bookcase or cabinet that may impede the flow of air through the ventilation openings. Ventilation should not be impeded by covering the openings with items such as newspapers, tablecloths, curtains, etc.
8. Do not install near any heat sources such as radiators, heat registers, stoves, or other apparatus (including amplifiers) that produce heat.
9. No naked flame sources, such as lighted candles, should be placed on the apparatus.

10. Do not defeat the safety purpose of the polarized or grounding-type plug. A polarized plug has two blades with one wider than the other. A grounding type plug has two blades and a third grounding prong. The wide blade or the third prong is provided for your safety. If the provided plug does not fit into your outlet, consult an electrician for the replacement of the obsolete outlet.
11. Protect the power cord from being walked on or pinched – particularly at plugs, convenience receptacles, and the point where they exit from the apparatus.
12. Do not install in an area that impedes the access to the power plug. Disconnecting the power plug is the only way to completely remove power to the product and must be readily accessible at all times.
13. Power source – Use only power supplies of the type specified in the operating instructions or as marked on the appliance. If a separate power supply is included with this apparatus, do not substitute with any other power supply – use only manufacturer-provided power supplies.
14. Unplug this apparatus during lightning storms or when unused for long periods of time.
15. Refer all servicing to qualified service personnel. Servicing is required when the apparatus has been damaged in any way, such as power-supply cord or plug is damaged, liquid has been spilled or objects have fallen into the apparatus, the apparatus has been exposed to rain or moisture, does not operate normally, or has been dropped. For service, refer to qualified service personnel, return to the dealer, or call the Altec Lansing service line for assistance.
16. For products that incorporate batteries, please refer to local regulations for proper battery disposal.
17. Only use attachments/accessories specified by the manufacturer.



18. Use only with the cart, stand, tripod, bracket, or table specified by the manufacturer or sold with the apparatus. When a cart is used, use caution when moving the cart/apparatus combination to avoid injury from tip-over.

Contents

Welcome.....	ii
Safety Information	1
Package Contents.....	3
Getting Started.....	4
Placing and Removing Adapters for the iPhone and iPod.....	5
Speaker Features and Indicators	6
Speaker Controls.....	7
Enhanced Remote Features.....	9
Listening to Your iPhone or iPod.....	11
Charging your iPhone or iPod	12
Listening to the FM Radio	12
Listening to a Non-docking iPod or Other Portable Audio Device.....	13
Maintaining Your Speaker System	13
Troubleshooting.....	14
Warranty	17

Package Contents

Altec Lansing inMotion Max speaker system

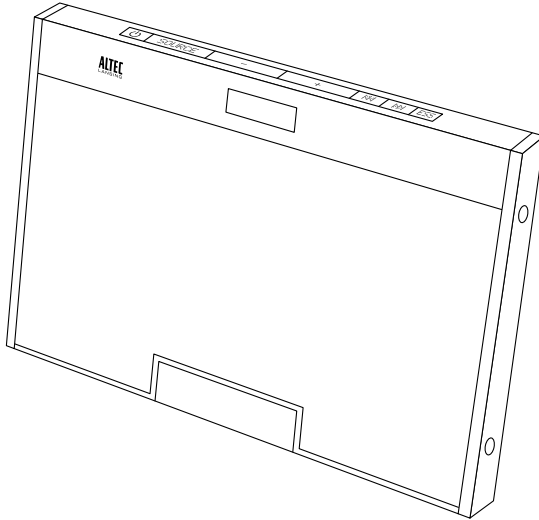

User Guide and Quick Connect Instructions

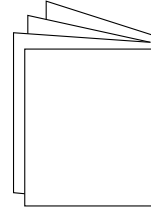

Enhanced remote

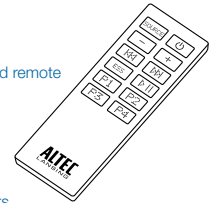

Miscellaneous adapters for iPhone and iPod

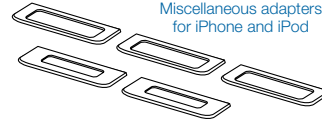

AC adapter

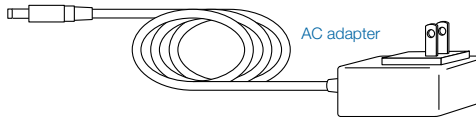

FM radio antenna

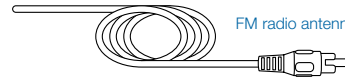

Getting Started

How to Install the AC Adapter

- 1 Connect the AC adapter cable plug into the speaker system's jack.**

The jack is located on the back of the system.

- 2 Plug the AC adapter into the wall outlet.**

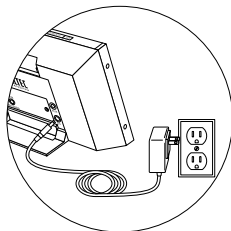

How to Charge the Lithium-Ion Battery

Your Altec Lansing inMotion Max speaker system includes a rechargeable lithium-ion battery. This battery should be fully charged before initial use of the speaker system. A full charge will provide up to 3.5 hours of continuous playing time.

When the battery icon on the LCD screen displays a single segment, you should recharge the battery. When the battery icon starts flashing, the speaker system is about to automatically shut down.

- 1 Connect the speaker system to a wall outlet.**

See the *How to Install the AC Adapter* section. The battery icon on the LCD screen will show the battery is charging.

- 2 Allow the battery to charge.**

Charging time: Up to 3 hours for a full charge. When the battery is fully recharged, the battery icon is shown as full.

WARNING During the recharging process, it is typical for the battery to become warm. To be safe, keep flammable materials away from the speaker system.

How to Disconnect the Rechargeable Battery

If you need to replace the lithium-ion battery, you will need to first remove it.

- 1 Unplug the speaker system from the wall outlet.**
- 2 Remove the rechargeable battery compartment cover.**

The battery compartment is located on the back of the speaker system. Remove the 2 screws securing the cover in place. Then remove the cover.
- 3 Unplug the battery and remove it.**

NOTE The lithium-ion battery must be properly recycled or disposed of. Please contact your local recycling center for proper battery handling and disposal instructions.

How to Install the Enhanced Remote Battery

The enhanced remote battery (included) is not installed at the factory. To install the battery, follow the steps below:

- 1 Pull out the battery holder.**

The battery door is located on the lower end of the remote. Simply pull the tab to open the battery holder.
- 2 Position the battery (included) so it sits in the battery holder correctly.**

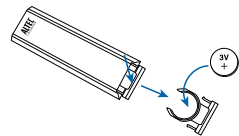

Make sure the polarity (the + and – sides of the battery) is correct.

- 3 Replace the battery door.**

NOTE Please discard used batteries properly.

Placing and Removing Adapters for the iPhone and iPod

Your Altec Lansing inMotion Max speaker system includes removable adapters for today's popular iPhone and iPod models. These adapters ensure that your iPhone and iPod properly fit in the speaker system's dock. As new iPhone and iPod models are introduced, new adapters will be made available to customers. You may also use the adapters supplied with your iPhone or iPod or available for purchase at www.apple.com.

How to Place an Adapter

1 Select the correct adapter for your iPhone or iPod.

Using the correct adapter ensures a proper fit for your iPhone or iPod.

2 Gently press the iPhone or iPod adapter into the dock.

Now you can carefully place your iPhone or iPod into the dock.

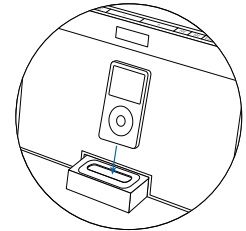

NOTE Your iPhone or iPod cannot be in a case or a "skin."

How to Remove an Adapter

1 Remove your iPhone or iPod.

2 Grip the adapter and pull gently upward.

Speaker Features and Indicators

Expanded Sound Stage technology button

Track forward button

Track back button

Volume increase button

Volume decrease button

Source button

Power
on/off
button

LCD
display

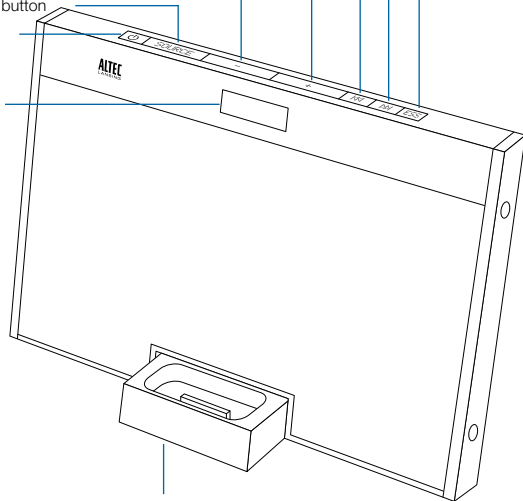

Universal docking station for iPhone or iPod

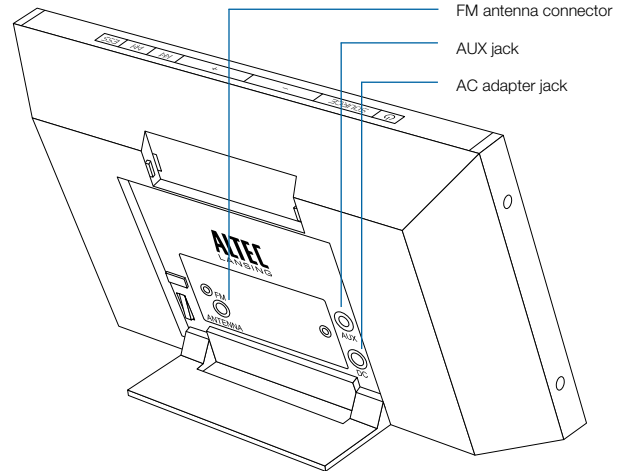











FM antenna connector

AUX jack

AC adapter jack

Speaker Controls

Turn on your speaker system	Ensure the AC adapter is connected to the system and plugged into the wall. See the <i>Getting Started</i> section for more information. Press the  button.
Turn off your speaker system	Press the  button. Whenever you are finished using your speaker system, please remember to turn it and your iPhone, iPod or other MP3 player off to conserve electricity.
Change audio source	Press the SOURCE button to cycle through and select the audio source: iPod, FM radio or AUX.
Turn up the volume	Press the + button.
Turn down the volume	Press the – button.
Skip to the beginning of the current song on your iPhone or iPod	In “iPod” mode, press the  button.
Rewind the currently playing track on your iPhone or iPod	In “iPod” mode, press and hold the  button.
Skip to the beginning of the next song on your iPhone or iPod	In “iPod” mode, press the  button.
Fast-forward the currently playing track on your iPod	In “iPod” mode, press and hold the  button.
Tune radio stations	In “FM” mode, use the  and  buttons. See the <i>Listening to the Radio</i> section for additional information.
Scan radio stations	In “FM” mode, press and hold the  or  button. See the <i>Listening to the Radio</i> section for additional information.

Speaker Controls

Listen to a non-docking iPod or MP3 player

See the *Listening to a Non-docking iPod or Other Portable Audio Device* section for specific information on using devices attached to your speaker system's AUX jack.

Activate Expanded Sound Stage (ESS) technology

Proprietary ESS technology widens the stereo image to fill a room with sound. Press the ESS button to activate it.

Reset all settings







Press the ϕ and SOURCE buttons simultaneously for a few seconds. Once the word "RESET ?" is displayed on the screen, press the ϕ button to reset all settings.

Select FM Band region

Reset all settings (see above), and use the + and – buttons to select the region closest to you ("REGION 1: USA," "REGION 2: EUROPE," "REGION 3: JAPAN WIDE," or "REGION 4: JAPAN.") Then, press the ϕ button to save your selection.

Enhanced Remote Features

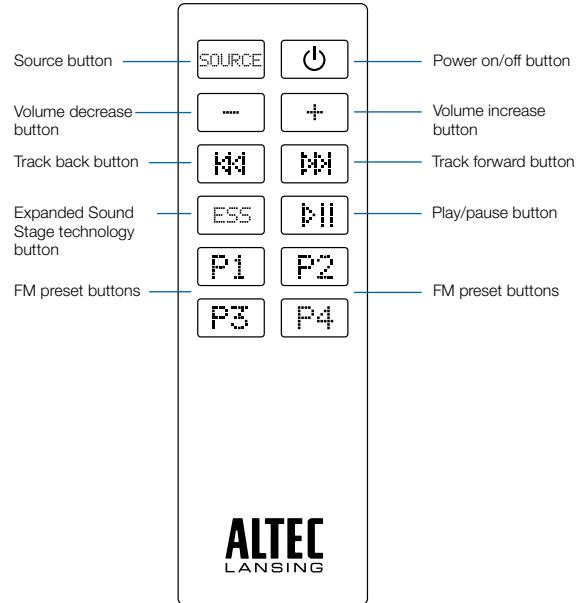

The enhanced remote lets you operate many functions of your Altec Lansing inMotion Max speaker system:

Turn on your speaker system	Press the  button.
Turn off your speaker system	Press the  button.
Change audio source	Press the SOURCE button to cycle through and select the audio source: iPod, FM radio or AUX.
Turn up the volume	Press the + button.
Turn down the volume	Press the – button.
Play/Pause a song on your iPhone or iPod	In "iPod" mode, press the  button to begin playing a selected track. Press the button again to pause it.
Skip to the beginning of the current song on your iPhone or iPod	In "iPod" mode, press the  button.
Rewind the currently playing track on your iPhone or iPod	In "iPod" mode, press and hold the  button.
Skip to the beginning of the next song on your iPhone or iPod	In "iPod" mode, press the  button.
Fast-forward the currently playing track on your iPhone or iPod	In "iPod" mode, press and hold the  button.



Enhanced Remote Features

Tune radio stations

In "FM" mode, use the  or  buttons. See the *Listening to the Radio* section for additional information.

Seek radio stations

In "FM" mode, press and hold the  or  button. See the *Listening to the Radio* section for additional information.

Store a radio station

In "FM" mode, tune to the station you'd like to store, and then press and hold one of the PRESET buttons (P1, P2, P3 or P4). See the *Listening to the Radio* section for more information.

Select a preset radio station

In "FM" mode, press the PRESET button (P1, P2, P3 or P4) that corresponds to the station you'd like to hear. See the *Listening to the Radio* section for more information.

Activate Expanded Sound Stage (ESS) technology

Proprietary ESS technology widens the stereo image to fill a room with sound. Press the ESS button to activate it.

NOTE For best results, aim the enhanced remote control toward the inMotion Max speaker system.

Listening to Your iPhone or iPod

1 Dock your iPhone or iPod in the Altec Lansing inMotion Max speaker system.

2 Select “iPod” mode.

Press the SOURCE button on your speaker system or enhanced remote until the iPod icon appears on the LCD.





3 Press the  button on your iPhone or iPod.

Music from your iPhone or iPod will start playing. The speaker system and its remote are capable of controlling basic functions of 3rd-generation iPod models, the iPod touch and iPhone.



4 Adjust the volume.

Use the + and – buttons on the Altec Lansing speaker system to adjust the system volume. Or, use the + and – buttons on the enhanced remote.

5 Find your desired song.

Press the  or  button on your speaker system or enhanced remote to go to the next or previous track. Press and hold the  or  button on your speaker system or enhanced remote while track is playing for high-speed forward or reverse music search of the current track.

NOTE To conserve battery power, reduce the speaker system volume level.

NOTE During battery-only operation, the speaker system automatically shuts down if no audio is detected for a few minutes. Press the  button to turn the speaker system back on. (If the speaker system is connected to a wall outlet, it will remain on until the  button is pressed and the indicator light shuts off.)

NOTE The speaker system is compatible with the alarm clock and sleep timer features built into select iPhone and iPod models. For these features to work properly, the speaker system must be connected to a wall outlet. See the user guide for iPhone or iPod for details on how to access these features.

How to Access Additional Features on Your iPhone or iPod Using the Enhanced Remote

Shuffle function

Press the P1 button once on the enhanced remote to advance to the next shuffle mode. SH ALBU is displayed when the system is in album shuffle mode. SH SONG is displayed when the system is in song shuffle mode. SH OFF is displayed when the shuffling function has been turned off. Note: Use the P2 button on some older iPod models. Functionality may vary per iPhone or iPod model.

Repeat function

Press the P2 button once on the enhanced remote to advance to the next repeat mode. RPT ONE is displayed when the system is in the repeat one mode. RPT ALL is displayed when the system is the repeat all mode. RPT OFF is displayed when the repeat function has been turned off. Note: Use the P2 button on some older iPod models. Functionality may vary per iPhone or iPod model.

Access the previous playlist

Press the P3 button on the enhanced remote.

Access the next playlist

Press the P4 button on the enhanced remote.

Charging Your iPhone or iPod

Whenever your iPhone or iPod is docked and your Altec Lansing inMotion Max speaker system is plugged into an AC outlet, your iPhone or iPod is charging (until fully charged) – even if the speaker system is switched off.

Listening to the FM Radio

1 Plug the FM radio antenna into the speaker system's FM ANTENNA jack.

The jack is located on the back of the system.

2 Extend the FM antenna wire fully for best FM reception. Also, do not strip, alter or attach to other antennas.

3 Select "FM" mode.

Press the SOURCE button on your speaker system or enhanced remote until the **FM** appears on the LCD.

4 Tune to the station you want to listen to.

Use the **FM** and **FM** buttons on your speaker system or enhanced remote to tune in the desired station. Press and hold these same buttons to find the next clear FM station.

5 Adjust the volume.

Use the + and – buttons on the Altec Lansing speaker system to adjust the system volume. Or, use the + and – buttons on the enhanced remote.

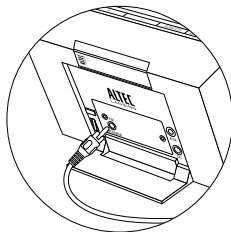

How to Store Preset Stations

Your Altec Lansing speaker system's enhanced remote enables you to program up to 4 FM station presets:

1 Tune to the station you wish to store.

While in "FM" mode, use the **FM** and **FM** buttons on your speaker system or enhanced remote to tune to the desired station.

2 Store the station.

Press and hold the P1, P2, P3 or P4 button on the enhanced remote for a few seconds. You can store one FM station in each preset.

3 To store other stations, repeat the above steps.

How to Recall Preset Stations

1 Make sure you are in "FM" mode.

If you're not in "FM" mode, press the SOURCE button on your speaker system or enhanced remote until the **FM** appears on the LCD.

2 Press a PRESET button (P1, P2, P3 or P4) on the enhanced remote.

The radio will tune to your preset station.

3 Adjust the volume.

Use the + and – buttons on the Altec Lansing speaker system to adjust the system volume. Or, use the + and – buttons on the enhanced remote.

Listening to a Non-docking iPod or Other Portable Audio Device

If you have a non-iPod MP3 player or other non-docking portable audio device, you can enjoy it through your Altec Lansing inMotion Max speaker system as well. Just connect it via the AUX jack. Here's how:

- 1 Locate a 3.5 mm stereo cable (not included).**

- 2 Plug one end of the stereo cable into your device.**

Your device should have either a headphone or LINE OUT jack for you to plug into.

- 3 Plug the other end of the stereo cable into your speaker system's AUX jack.**

The AUX jack is located on the back of the unit.

- 4 Select "AUX" mode.**

Press the SOURCE button on your speaker system or the enhanced remote until the AUX icon appears on the speaker system's LCD.

- 5 Turn on your device and start it playing.**

- 6 Adjust the volume.**

Use the + and – buttons on the speaker system to adjust the volume. Or, use the + and – buttons on the enhanced remote.

NOTE You may need to adjust the device volume also. Your device's volume should be set to approximately $\frac{3}{4}$ volume.

- 7 When you are finished listening to your portable audio device, please remember to turn both it and your speaker system off to conserve electricity.**

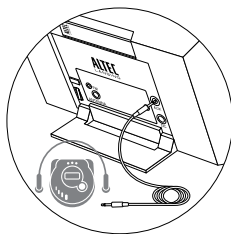

Maintaining Your Speaker System

Place your speaker system on a level surface away from sources of direct sunlight or excessive heat.

Protect your furniture with a cloth or other protective material when placing your speaker system on a natural wood or lacquered finish.

Clean your speaker system with a soft cloth moistened only with mild soap and water. Stronger cleaning agents, such as benzene, thinner or similar materials, can damage the surface of the unit.

Troubleshooting

Symptom	Possible Problem	Solution
Speaker system doesn't respond (no power)	AC adapter isn't plugged into a wall outlet or the connector isn't plugged into the power supply jack on the back of the speaker system	Plug the AC adapter into a wall outlet and plug the connector into the power supply jack on the back of the speaker system.
	Wall outlet is not functioning	Plug another device into the same outlet to confirm the outlet is working.
	The rechargeable battery isn't charged.	Recharge the battery. (See the <i>Getting Started</i> section for details.)
	The power isn't turned on.	Turn on the speaker system by pressing the ⏻ button. The indicator light turns on.
iPhone or iPod doesn't dock properly	Using the wrong adapter for iPhone or iPod or no adapter	Make sure the adapter is the proper fit for your iPhone or iPod.
	iPhone or iPod didn't install properly	Remove your iPhone or iPod from the dock and check for obstruction on the connectors in the dock and on your iPhone or iPod. Then reseal it in the dock.
iPhone or iPod doesn't respond to the speaker system	iPhone or iPod is not installed properly	Remove your iPhone or iPod from the dock and check for obstructions on the connectors in the dock and on your iPod. Then reseal it in the dock.
	Your iPhone or iPod software is too old	Upgrade software on your iPhone or iPod. For details visit www.apple.com/ipod/download .
	iPhone or iPod is locked up	Please make sure your iPhone or iPod is working properly before docking into the unit. Please refer to your iPhone or iPod manual for details.
	Using 1st- or 2nd-generation iPod, iPod shuffle or other devices	Your speaker system cannot control those iPods or other devices.

Symptom	Possible Problem	Solution
iPhone or iPod didn't charge	iPhone or iPod is not installed properly	Remove your iPhone or iPod from the dock and check for obstructions on the connectors in the dock and on your iPhone or iPod. Then reseat it in the dock.
	iPhone or iPod is locked up	Please make sure your iPhone or iPod is working properly before docking into the unit. Please refer to your iPhone or iPod manual for details.
	AC adapter isn't plugged into a wall outlet, or the connector is not plugged into the power supply jack on the back of the speaker system	Plug the AC adapter into a wall outlet and plug the connector into the supply jack on the speaker system.
Sound is distorted	Volume level is set too high	Decrease the volume.
	Sound source is distorted	If the iPhone or iPod original sound source (MP3) is of poor quality, distortion and noise are easily noticed with high-power speakers. Try a different audio source such as a music CD.
Enhanced remote doesn't work	Battery is weak	Replace current battery with a new battery.
	Enhanced remote is not pointed toward the speaker system	Point the enhanced remote toward the Altec Lansing speaker system and move within 10 feet of the unit.
No sound from the AUX device, such as an MP3 player or CD player connected to the AUX jack	Volume on the device is set too low	Increase the volume on the device to approximately $\frac{3}{4}$ full volume.
	Source selector is not set to AUX	Set source selector to AUX.

Troubleshooting

Symptom	Possible Problem	Solution
The speaker system exhibits erratic or unexpected behavior. Controls do not function.	Static electricity, momentary interruption of power or abnormal operating conditions may be responsible.	<ol style="list-style-type: none">1. Disconnect the AC adapter cable plug from the speaker system's jack.2. Close the stand on the back of the speaker system.3. Wait 20–30 seconds.4. Open the stand on the back of the speaker system.5. Reconnect the AC adapter cable plug to the speaker system's jack.

ALTEC LANSING ONE-YEAR LIMITED WARRANTY

What Does the Warranty Cover?

Altec Lansing warrants that its products shall be free from defects in materials or workmanship, with the exceptions stated below.

What Is the Period of Coverage?

This warranty runs for one year from the date of purchase. The term of any warranties implied by law shall expire when your limited warranty expires. Some states and/or Member States in the European Union do not allow limitations on how long an implied warranty lasts, so the above limitation may not apply to you.

What Does the Warranty Not Cover?

This warranty does not cover any defect, malfunction or failure that occurs as a result of: improper installation; misuse or failure to follow the product directions; abuse; or use with improper, unintended or faulty equipment. (For information on proper installation, operation and use consult the manual supplied with the product. If you require a replacement manual, you may download a manual from www.alteclansing.com.) Also, consequential and incidental damages are not recoverable under this warranty. Some states do not allow the exclusion or limitation of incidental or consequential damages, so the above limitation or exclusion may not apply to you.

What Will Altec Lansing Do to Correct the Problem?

Altec Lansing will, at its option, repair or replace any product that proves to be defective in material or workmanship. If your product is no longer being manufactured, or is out of stock, at its option, Altec Lansing may replace your product with a similar or better Altec Lansing product.

How to Get Warranty Service

To get a covered product repaired or replaced, you must contact Altec Lansing during the warranty period by email (csupport@alteclansing.com). You must include in your email, your name, address, email address, telephone number, date of purchase and a complete description of the problem you are experiencing. In the United States, you may alternatively contact Altec Lansing by telephone at 1-800-ALTEC88. Please be prepared to provide the same information. If the problem appears to be related to a defect in material or workmanship, Altec Lansing will provide you a return authorization and instructions for return shipment. Return shipments shall be at the customer's expense, and the return must be accompanied by the original proof of purchase. You should insure the shipment as appropriate because you are responsible for the product until it arrives at Altec Lansing.

How Will State Law Affect Your Rights?

This warranty gives you specific legal rights, and you may also have other rights, which vary from state to state. Please note that in the European Union, you as a consumer might have other legal rights under national legislation of European Union Member States governing the sale of Altec Lansing's goods. Those rights are not affected by this guarantee.

The above limited warranties and remedies are sole warranties and remedies available to purchaser, if, and to the extent, valid and enforceable under the applicable law.

DISPOSAL OF OLD ELECTRICAL AND ELECTRONIC EQUIPMENT



This symbol on the product or on its packaging indicates that this product shall not be treated as household waste. Instead it shall be handed over to the applicable collection point for the recycling of electrical and electronic equipment. By ensuring this product is disposed of correctly, you will help prevent potential negative consequences for the environment and human health, which could otherwise be caused by inappropriate waste handling of this product. The recycling of materials will help to conserve natural resources.

For more detailed information about recycling of this product, please contact your local city office or your household waste disposal service.



www.alteclansing.com

HEADQUARTERS 535 Rte. 6 & 209, Milford, PA 18337-0277 • 800-ALTEC-88. 570-296-4434. • Fax 570-296-6887

EUROPE 13 Rue Beaumont, L-1219 Luxembourg, Luxembourg

ASIA/PACIFIC 23/F, Office Tower, Shun Hing Square Diwang Commercial Centre, 5002 Shen Nan Dong Road, Shenzhen, China 518008

"Made for iPod" means that an electronic accessory has been designed to connect specifically to iPod and has been certified by the developer to meet Apple performance standards.

"Works with iPhone" means that an electronic accessory has been designed to connect specifically to iPhone and has been certified by the developer to meet Apple performance standards.

Apple is not responsible for the operation of this device or its compliance with safety and regulatory standards.

Patents pending.

©2008 Plantronics, Inc. All rights reserved.

ALTEC, ALTEC LANSING, the Altec Lansing logo, the horn design, inMotion, and iMT702 are trademarks or registered trademarks of Altec Lansing, a division of Plantronics, Inc. Plantronics, the logo design, and Sound Innovation are trademarks or registered trademarks of Plantronics, Inc.

iPod is a trademark of Apple, Inc., registered in the U.S. and other countries.

iPhone is a trademark of Apple, Inc.

All other trademarks appearing herein are the property of their respective owners.

Designed by Altec Lansing in the USA. Made in China.



A12896 R04