

Digital Video Camcorder

Mini DV Digital
Video
Cassette

VP-D340/D340i
VP-D380/D380i

- AF** Auto Focus
CCD Charge Coupled Device
LCD Liquid Crystal Display

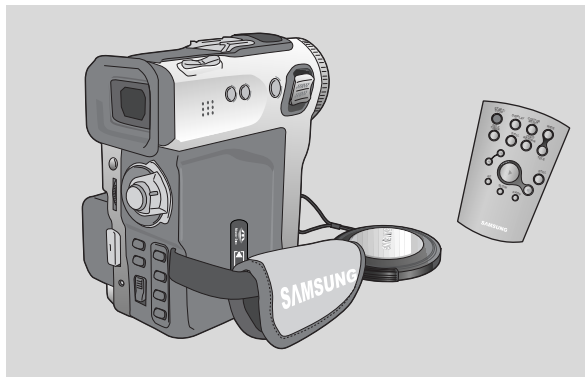

Owner's Instruction Book

Before operating the unit, please read this instruction book thoroughly, and retain it for future reference.

SAMSUNG
ELECTRONICS



This product meets the intent of
Directive 89/336 CEE, 73/23 CEE, 93/68 CEE.

Contents

Notes and Safety Instructions	6
Notes regarding the rotation of the LCD screen	6
Notes regarding moisture condensation	7
Notes regarding the Camcorder	7
Notes regarding the battery pack	8
Notes regarding Video Head Cleaning	8
Note regarding the LENS	9
Notes regarding electronic viewfinder	9
Notes regarding 'Record' or 'Playback' using the LCD	9
Notes regarding the hand strap	9
Precautions regarding the Lithium battery	10
Getting to Know Your Camcorder	11
Features	11
Accessories Supplied with the camcorder	12
Basic Accessories	12
Front & Left View	13
Right & Top View	14
Rear & Bottom View	15
Remote control	16
OSD (On Screen Display in Cam and VCR modes)	17
OSD (On Screen Display in M.REC and M.PLAY modes)	18
Turning the OSD on/off (On Screen Display)	18
How to use the Remote Control	19
Battery Installation for the Remote Control	19
Self Record using the Remote Control	19
Preparation	20
Adjusting the Hand Strap	20
Hand strap	20
Connecting a Power Source	21
To use the AC Power adapter and the DC Cable	21
Using the Lithium Ion Battery Pack	22
Charging the Lithium Ion Battery Pack	22
Table of continuous recording time based on model and battery type	23
Battery level display	24
Inserting and Ejecting a Cassette	25
BASIC Recording	26
Making your First Recording	26
Edit Search	27

Contents

Hints for Stable Image Recording	28
Recording with the LCD monitor	28
Recording with the Viewfinder	28
Adjusting the LCD	29
Using the VIEWFINDER	30
Adjusting the Focus	30
Playing back a tape you have recorded on the LCD	31
Adjusting the LCD during PLAY	32
Controlling Sound from the Speaker	32
Advanced Recording	33
Use of various Functions	33
Setting menu items	33
Set the camcorder to CAM or VCR mode and M.REC or M.PLAY mode (VP-D380/D380i only)	33
Availability of functions in each mode	34
RESET	34
CLOCK SET	35
REMOCON	36
BEEP SOUND	37
SHUTTER SOUND	38
DEMONSTRATION	39
PROGRAM AE	40
Setting the PROGRAM AE	41
WHT. BALANCE (WHITE BALANCE)	42
Zoom ing In and Out with DIGITAL ZOOM	43
Zooming In and Out	43
Digital Zoom	44
EIS (Electronic Image Stabilizer)	45
DSE (Digital Special Effects) SELECT	46
Selecting an effect	47
CUSTOM.Q	48
REC MODE	49
AUDIO MODE	50
WIND CUT	51
DATE/TIME	52
TV DISPLAY	53
Using Quick Menu	54
Setting the Quick menu	55
SHUTTER SPEED & EXPOSURE	56
EASY Mode (for Beginners)	57
CUSTOM Mode	58
MF/AF (Manual Focus/Auto Focus)	59

Contents

Auto Focusing	59
Manual Focusing	59
BLC (Back Light Compensation)	60
Fade In and Out	61
To Start Recording	61
To Stop Recording (use FADE IN / FADE OUT)	61
Audio dubbing	62
Dubbing sound	62
Dubbed Audio Playback	63
PHOTO Image Recording	64
Searching for a PHOTO picture	64
Various Recording Techniques	65
Tape Playback	66
Playback on the LCD	66
Playback on a TV monitor	66
Connecting to a TV which has Audio Video input jacks	66
Connecting to a VCR	67
Playback	67
Various Functions while in VCR mode	68
Playback pause	68
Picture search (Forward/Reverse)	68
Slow playback (Forward/Reverse)	68
Frame advance (To play back frame by frame)	69
X2 Playback (Forward/Reverse)	69
ZERO MEMORY	70
IEEE 1394 Data Transfer	71
Transferring IEEE1394 (i.LINK)-DV standard data connections	71
Connecting to a DV device	71
Connecting to a PC	71
System requirements	72
Recording with a DV connection cable (VP-D340i/D380i only)	72
USB interface	73
Transferring a Digital Image through a USB Connection	73
System Requirements	73
Installing DVC Media 2.0 Program	74
Installing DVC Media 4.0 Program	76
Connecting to a PC	78
Digital Still Camera mode (VP-D380/D380i only)	79
Memory Stick	79
Memory Stick Functions	79

Contents

Inserting and ejecting the Memory Stick	80
Inserting the Memory Stick	80
Removing the Memory Stick	80
Structure of folders and files on the Memory Stick	81
Image Format	81
Selecting the image quality	82
Select the image quality	82
Number of images on the Memory Stick	82
Recording Still images to a Memory Stick in M.REC mode	83
Recording images to a Memory Stick	83
Recording an image from a cassette as a still image	84
Viewing Still images	85
To view a Single image	85
To view a slide show	85
To view the Multi Screen	86
Copying still images from a cassette to Memory Stick	87
Marking images for printing	88
Protection from accidental erasure	89
Deleting Still images	90
Formatting a Memory Stick	91
Attention	91
Maintenance	92
After finishing a recording	92
After completing a recording session	92
Cleaning and Maintaining the Camcorder	93
Cleaning the VIEWFINDER	93
Cleaning the Video Heads	93
Using Your Camcorder Abroad	94
Power sources	94
Colour system	94
Troubleshooting	95
Troubleshooting	95
Self Diagnosis Display	95
Moisture Condensation	95
Self Diagnosis Display in M.REC, M.PLAY mode (VP-D380/D380i only)	96
Specifications	98
INDEX	99
Warranty	100

Notes and Safety Instructions

Notes regarding the rotation of the LCD screen

Please rotate the LCD screen carefully as illustrated.

Over rotation may cause damage to the inside of the hinge that connects the LCD screen to the Camcorder.

1. LCD screen closed.

2. Standard recording using the LCD screen.

3. Recording when looking at the LCD screen from the top.

4. Recording when looking at the LCD screen from the front.

5. Recording with the LCD screen closed.

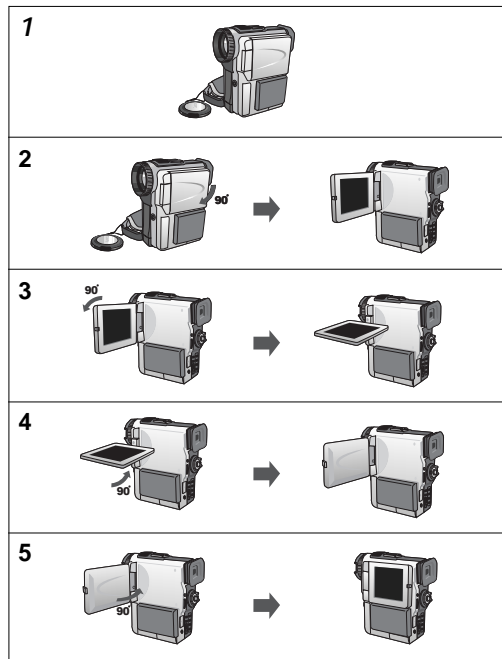

Notes and Safety Instructions

Notes regarding moisture condensation

1. A sudden rise in atmospheric temperature may cause condensation to form inside the camcorder.

for example:

- When you move the camcorder from a cold location to a warm location (e.g. from outside to inside during winter.)
 - When you move the camcorder from a cool location to a hot location (e.g. from inside to outside during the summer.)
2. If the  (DEW) protection feature is activated, leave the camcorder for at least two hours in a dry, warm room with the cassette compartment opened and the battery removed.

Notes regarding CAMCORDER

1. Do not leave the camcorder exposed to high temperature (above 60°C or 140°F).
For example, in a parked car in the sun or exposed to direct sunlight.
2. Do not let the camcorder get wet.
Keep the camcorder away from rain, sea water, and any other form of moisture. If the camcorder gets wet, it may get damaged.
Sometimes a malfunction due to exposure to liquids cannot be repaired.

Notes regarding COPYRIGHT

Television programs, video tapes, DVD titles, films, and other program materials may be copyrighted. Unauthorized copying of copyrighted material may be against the law.

Notes and Safety Instructions

Notes regarding the battery pack

- Make sure that the battery pack is fully charged before starting to record.
- To preserve battery power, keep your camcorder turned off when you are not operating it.
- If your camcorder is in CAMERA mode, and it is left in STBY mode without being operated for more than 5 minutes with a tape installed, it will automatically turn itself off to protect against unnecessary battery discharge.
- Make sure that the battery pack is fitted firmly into place.
Dropping the battery pack may damage it.
- A brand new battery pack is not charged.
Before using the battery pack, you need to charge it completely.
- It is a good idea to use the viewfinder rather than the LCD when making a long recording, because the LCD uses up more battery power.

* When the battery reaches the end of its life, please contact your local dealer. The batteries have to be dealt with as chemical waste.

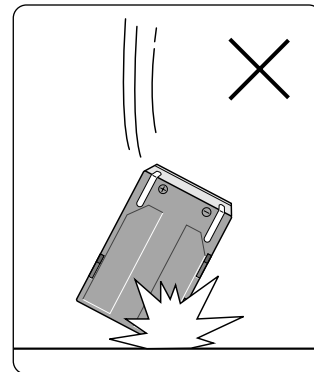

Notes regarding Video Head Cleaning

- To ensure normal recording and a clear picture, clean the video heads regularly. If a square block-shape distorts playback, or only a blue screen is displayed, the video heads may be dirty. If this happens, clean the video heads with a dry type cleaning cassette.
- Do not use a wet-type cleaning cassette. It may damage the video heads.

Notes and Safety Instructions

Note regarding the LENS

- Do not film with the camera lens pointing directly at the sun.
Direct sunlight can damage the CCD (Charge Coupled Device).

Notes regarding electronic viewfinder

1. Do not position the camcorder such that the viewfinder is pointing towards the sun.
Direct sunlight can damage the inside of the viewfinder. Be careful when placing the camcorder under sunlight or near a window exposed to sunlight.
2. Do not pick up the camcorder from the viewfinder.
3. Over-rotating of the viewfinder may damage it.

Notes regarding 'Record' or 'Playback' using the LCD

1. The LCD display has been manufactured using high precision technology. However, there may be tiny dots (red, blue or green in colour) that appear on the LCD display.
These dots are normal and do not affect the recorded picture in any way.
2. When you use the LCD display under direct sunlight or outdoors, it maybe difficult to see the picture clearly.
If this occurs, we recommend using the viewfinder.
3. Direct sunlight can damage the LCD monitor.

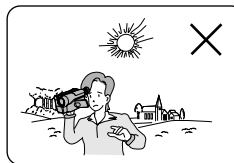

Notes regarding the hand strap

- To ensure a steady picture during filming, check that the hand strap is properly adjusted.
- Do not force your hand into the hand strap as you could damage it.

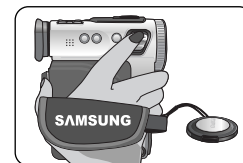

Notes and Safety Instructions

Precautions regarding the Lithium battery

1. The camcorder's built-in lithium battery maintains the clock function and user settings, even if the battery pack or AC adapter is removed.
2. The lithium battery for the camcorder lasts about 1 month under normal operation from the time of installation.
3. When the lithium battery becomes weak or is dead, the date/time indicator will flash for about five seconds when you set the power switch to CAM mode.
When this occurs, connect the camcorder to power to fully recharge the built-in lithium battery.
If the same problem occurs with a fully recharged battery, contact a Samsung authorized Service Centre to replace the battery.

Precautions regarding the external lithium battery for the remote control

Warning:

- **Keep the LITHIUM BATTERY(Remote Control) out of reach of children.**
Should a battery be swallowed, consult a doctor immediately.
- **Danger of explosion if battery is incorrectly replaced.**
Replace only with the same or equivalent type.

Getting to Know Your Camcorder

Features

- **Digital data transfer function with IEEE1394**
By incorporating the IEEE 1394 (i.LINK™ : i.LINK is a serial data transfer protocol and interconnectivity system, used to transmit DV data) high speed data transport port, both moving and still images can be transferred to a PC, making it possible to produce or edit various images.
(VP-D340/D380 is not able to record and receive digital data from another DV Device.)
- **USB interface for digital image data transfer**
You can transfer still images and short video clips to a PC using the USB interface without an add-on card.
- **PHOTO**
The PHOTO function lets you capture an object as a still along with sound, while in Camera mode.
- **480x Digital zoom**
Allows you to magnify an image up to 480 times its original size.
- **Colour TFT LCD**
A high-resolution colour TFT LCD (with 200,000 pixels) gives you clean, sharp images as well as the ability to review your recordings immediately.
- **Electronic Image Stabilizer (EIS)**
The EIS compensates for any handshake, reducing unstable images particularly at high magnification.
- **Various digital effects**
The DSE (Digital Special Effects) allow you to give your films a special look by adding various special effects.
- **Back Light Compensation (BLC)**
The BLC function compensates for the bright background behind a subject you're recording.
- **Program AE**
The Program AE enables you to alter the shutter speed and aperture to suit the type of scene/action to be filmed.
- **Digital Still Camera function (VP-D380/D380i only)**
 - Using Memory Stick, you can easily record and play back standard still images.
 - You can transfer standard still images on the Memory Stick to your PC using the USB interface.







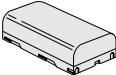

Getting to Know Your Camcorder

Accessories Supplied with camcorder

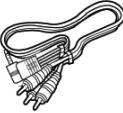
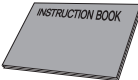
Make sure that the following basic accessories are supplied with your digital video camera.

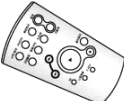
Basic Accessories

1. Lithium Ion Battery pack
2. AC Power Adapter
3. AC Cord
4. AUDIO/VIDEO cable
5. Instruction Book
6. Lithium battery for Remote Control (TYPE: CR2025, 1 EA)
7. S-VIDEO cable
8. Remote Control
9. USB cable
10. Software CD
 - VP-D340/D340i: DVC Media 2.0
 - VP-D380/D380i: DVC Media 4.0
11. Memory Stick (VP-D380/D380i only)
12. USB AUDIO cable (VP-D340/D340i only)

1. Lithium Ion Battery pack 	2. AC Power Adapter 	3. AC cord 
4. AUDIO/VIDEO cable 	5. Instruction Book 	6. Lithium battery (1EA) 
7. S-VIDEO cable 	8. Remote Control 	9. USB cable 
10. Software CD 	11. Memory Stick (VP-D380/D380i only) 	12. USB AUDIO cable (VP-D340/D340i only) 

Optional Accessory

13. Scart adapter

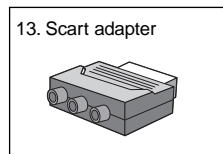

Getting to Know Your Camcorder

Front & Left View

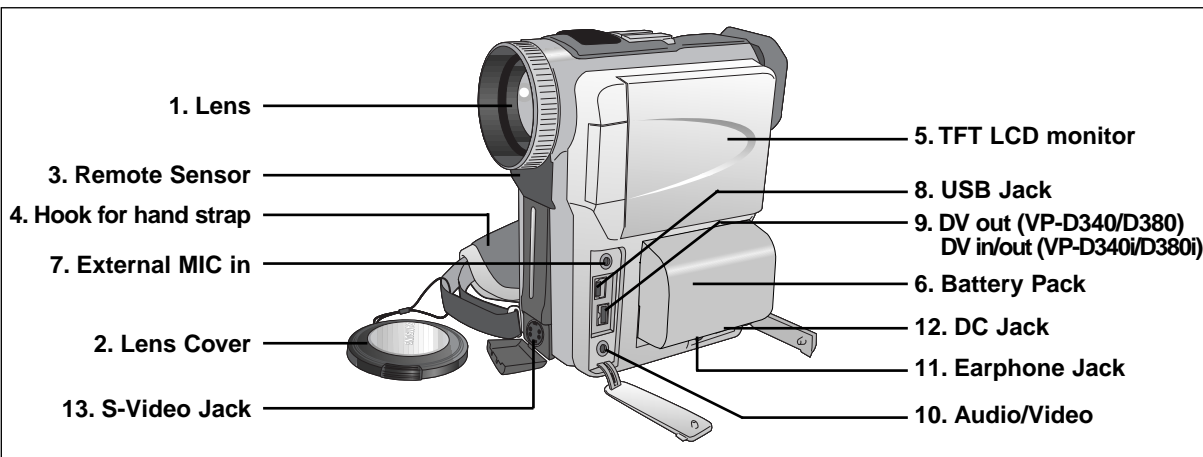

1. Lens

2. Lens Cover

3. Remote Sensor

4. Hook for hand strap (see page 20)

5. TFT LCD monitor

6. Battery Pack (see page 22)

7. External MIC in (see page 62)

8. USB Jack (see page 73)

9. DV out (VP-D340/D380 only, see pages 71, 72)
DV in/out (VP-D340i/D380i only)

10. Audio/Video (see page 67)

11. Earphone Jack

12. DC Jack (see page 21)

13. S-Video Jack

Getting to Know Your Camcorder

Right & Top View

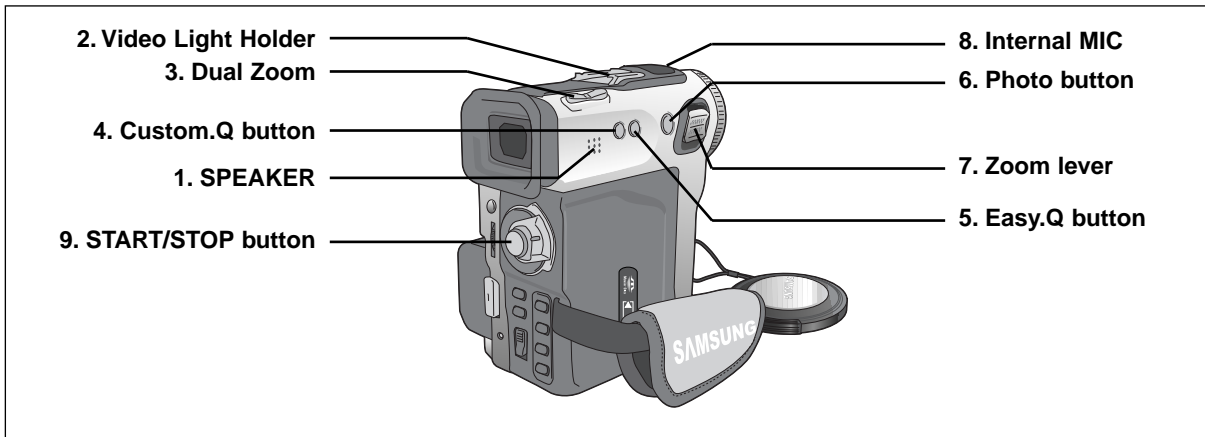

1. SPEAKER

2. Video Light Holder

3. Dual Zoom (See page 43)

4. Custom.Q button (See page 58)

5. Easy.Q button (See page 57)

6. Photo button (See page 64)

7. Zoom lever (See page 43)

8. Internal MIC

9. START/STOP button

Getting to Know Your Camcorder

Rear & Bottom View

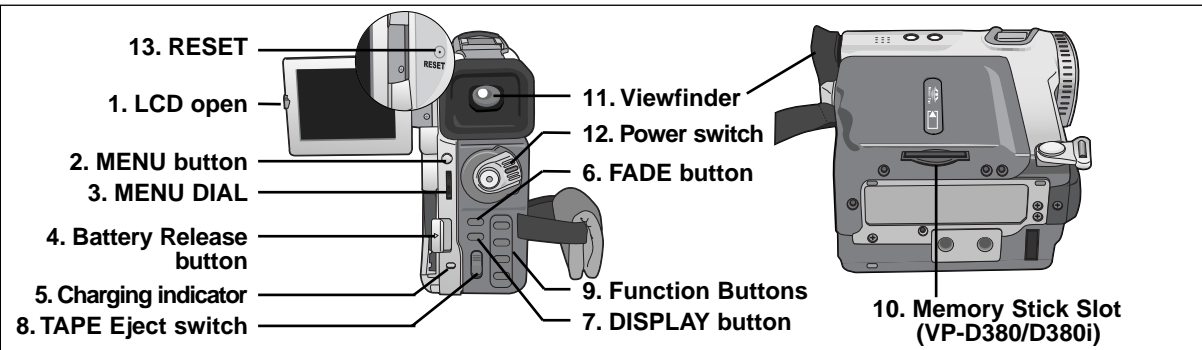

- 1. LCD open
- 2. MENU button (See page 33)
- 3. MENU DIAL (MENU SELECT/VOLUME/M.FOCUS) (See page 33)
- 4. Battery Release button (See page 92)
- 5. Charging indicator (See page 22)
- 6. FADE button (See page 61)
- 7. DISPLAY button
- 8. TAPE Eject switch
- 9. Function Buttons
- 10. Memory Stick Slot (VP-D380/D380i only)
- 11. Viewfinder (see page 30)
- 12. Power switch (see page 26)
- 13. RESET (see page 34)

Function Buttons

VCR	CAM	M.PLAY
◀ (REW)	EDIT -	REV
▶/II (PLAY/STILL)	MF/AF (See page 59)	S.SHOW
▶▶ (FWD)	EDIT +	FWD
■ (STOP)	BLC (See page 60)	DELETE (See page 90)

Getting to Know Your Camcorder

Remote control

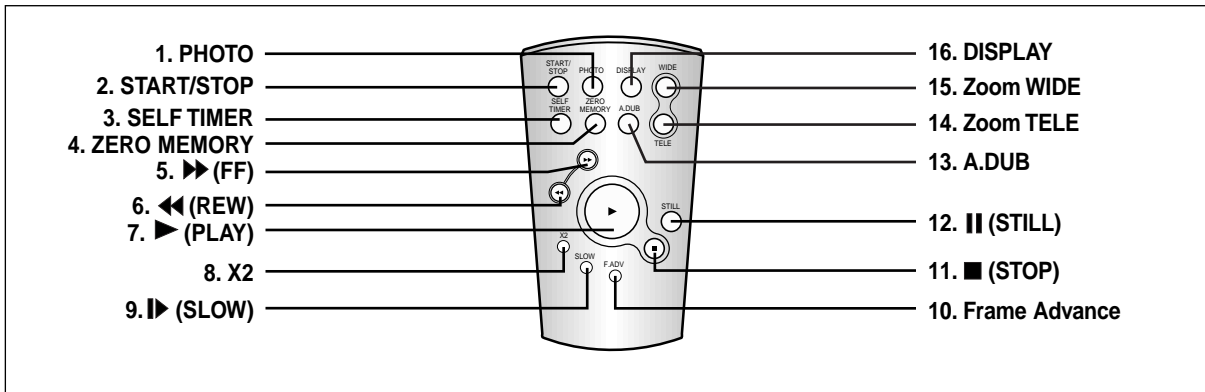

- 1. PHOTO
- 2. START/STOP
- 3. SELF TIMER (see page 19)
- 4. ZERO MEMORY (see page 70)
- 5. >>> (FF)
- 6. <<< (REW)
- 7. > (PLAY)
- 8. X2 (see page 69)
- 9. >> (SLOW)

- 10. Frame Advance (see page 69)
- 11. ■ (STOP)
- 12. || (STILL)
- 13. A.DUB (see page 62)
- 14. Zoom TELE
- 15. Zoom WIDE
- 16. DISPLAY (see page 17, 18)

Getting to Know Your Camcorder

OSD (On Screen Display in CAM and VCR modes)

1. Battery level (see page 24)
2. Custom or Easy mode (see pages 57, 58)
3. DSE (Digital Special Effects) mode (see page 46)
4. Program AE (see page 40)
5. White Balance mode (see page 42)
6. BLC (Back Light Compensation) (see page 60)
7. Manual focus (see page 59)
8. Shutter speed and EXPOSURE (see page 56)
9. Zoom position (see page 43)
10. DATE/TIME (see page 52)
11. USB
12. REMOCON
13. WIND CUT (see page 51)
14. Audio recording mode (see page 50)
15. Remaining Tape (measured in minutes)
16. Tape counter
17. Zero memory indicator (see page 70)
18. Operating mode
19. Record speed mode
20. PHOTO mode
21. Self recording and waiting timer (see page 19)
22. EIS (see page 45)
23. Volume control (see page 32)
24. Audio playback channel
25. DV IN (VP-D340i/D380i only) (DV data transfer mode) (see page 72)
26. DEW (See page 7)
27. Message Line

OSD in CAM mode

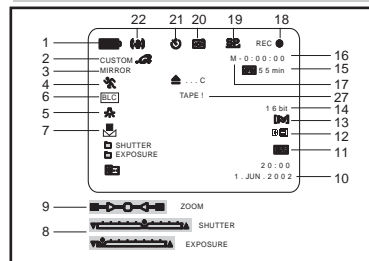

OSD in VCR mode

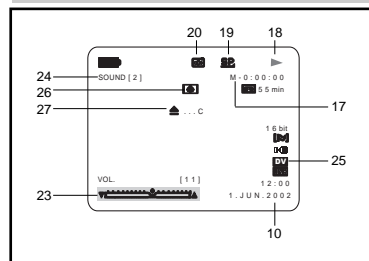

Getting to Know Your Camcorder

OSD (On Screen Display in M.REC/M.PLAY modes)

※ These items are available in for the VP-D380/D380i models only.

- 28. Folder number-file number (see page 81)
- 29. Image counter
 - Current still image/Total number of recordable still images.
- 30. CARD (memory) indicator
- 31. Image recording and loading indicator
- 32. Quality
- 33. ERASE PROTECTION indicator (see page 89)
- 34. Print Mark (see page 88)
- 35. SLIDE SHOW

Turning the OSD on/off (On Screen Display)

※ When you set the power switch to CAM or VCR, the OSD is automatically turned on.

• Turning OSD on/off

Press the DISPLAY button on the rear side panel.

- Each press of the button toggles the OSD function on and off.
- When you turn the OSD off,

In CAM mode: The STBY, EASY.Q, CUSTOM.Q and REC modes are always displayed on the OSD. Button inputs are displayed for 3 seconds then turned off.

In VCR mode: When you press any function button, the function is displayed on the OSD for 3 seconds before it turns off.

• Turning the DATE/TIME on/off

- The DATE/TIME is not affected when the OSD function is switched ON or OFF.
- To turn the DATE/TIME on or off, access the menu and change the DATE/TIME mode. (see page 52)
- You may also use the Dial Navigator to turn the DATE/TIME ON or OFF. (only in CAM / M.REC mode)

OSD in M.REC mode

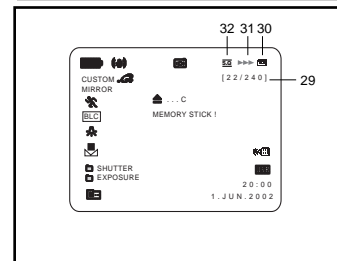

OSD in M.PLAY mode

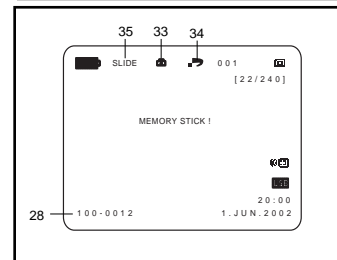

Getting to Know Your Camcorder

How to use the Remote Control

Battery Installation for the Remote Control

- ⌘ You need to insert or replace the lithium battery when :
 - You purchase the camcorder.
 - The remote control doesn't work.
- ⌘ Ensure that you insert the lithium cell correctly, following the + and - markings.
- ⌘ Be careful not to reverse the polarity of the battery.

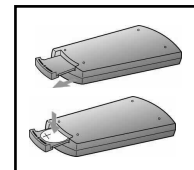

Self Record using the Remote Control

When you use the Self Timer function on the remote control, the recording begins automatically in 10 seconds.

1. Set the camcorder to CAM mode.
2. Press the SELF TIMER button until the appropriate indicator is displayed in the viewfinder.
3. Press the START/STOP button to start the timer.
 - After a 10 second wait, recording starts.
 - Press START/STOP again when you wish to stop recording

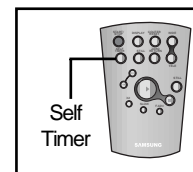

Preparation

Adjusting the Hand Strap

It is very important to ensure that the Hand strap has been correctly adjusted before you begin your recording.

The hand strap enables you to :

- Hold the camcorder in a stable, comfortable position.
- Press the Zoom and START/STOP button without having to change the position of your hand.

Hand strap

- Pull open the Hand Strap cover and release the Hand Strap.
- Adjust its length and stick it back onto the Hand Strap cover.
- Close the Hand Strap cover again.

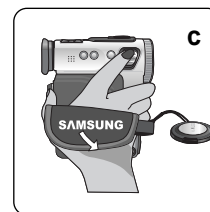
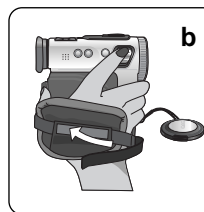
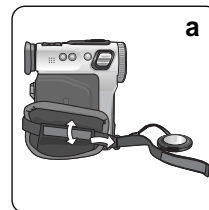

Preparation

Connecting a Power Source

There are two types of power source that can be connected to your camcorder.

- The AC Power Adapter and AC cord : used for indoor recording.
- The Battery Pack : used for outdoor recording.

To use the AC Power adapter and DC Cable

1. Connect the AC Power adapter to the AC cord.
2. Connect the AC cord to a wall socket.

Note

- The plug and wall socket type may differ according to your resident country.
3. Connect the DC cable to the DC jack socket of the camcorder.
 4. Set the camcorder to each mode by holding down the tab on the power switch and turning it to the CAM, VCR, M.REC, M.PLAY mode.

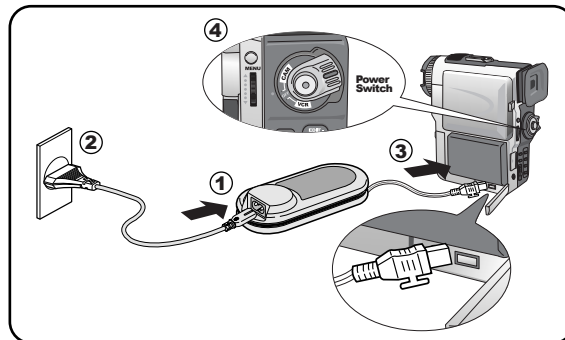

Preparation

Using the Lithium Ion Battery Pack

- ※ The amount of continuous recording time available depends on :
- The type and capacity of the battery pack you are using.
 - How often the Zoom function is used.
- It is recommended that you have several batteries available.

Charging the Lithium Ion Battery Pack

1. Attach the battery pack to the camcorder.
2. Connect the AC Power adapter to an AC cord and connect the AC cord to a wall socket.
3. Connect the DC cable to the DC jack socket on the camcorder.
4. Turn the Camera power switch to off, and the charging indicator will start to flash showing that the battery is charging.

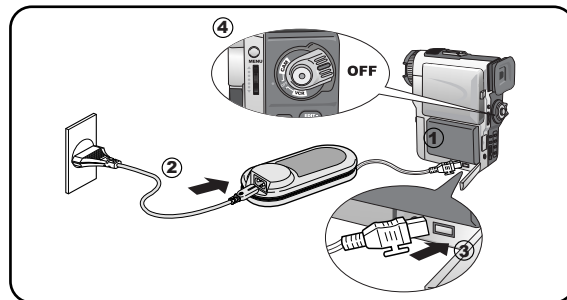

Blinking time	Charging rate
Once per second	Less than 50%
Twice per second	50% ~ 75%
Three times per second	75% ~ 90%
Blinking stops and stays on	90 ~ 100%
On for a second and off for a second	Error - Reset the battery and the DC cable

5. When the battery is fully charged, disconnect the battery and the AC Power adapter from the camcorder.
 - Even with the power switched off, the battery will still discharge if it is left connected to the camcorder.

Notes

- The battery pack may be charged a little at the time of purchase.
- To prevent reduction in the life and capacity of the battery pack, always remove it from the camcorder after it is fully charged.

Preparation

Using the Lithium Ion Battery Pack

Table of continuous recording time based on model and battery type.

- ⌘ If you close the LCD screen, it switches off and the CVF switches on automatically.
- ⌘ The continuous recording times given in the table above are approximations. Actual recording time depends on usage.

Time Battery	Charging time	Continuous recording time	
		LCD ON	CVF ON
SB-L70	Approx. 1hr 30min	Approx. 1hr	Approx. 1hr 30min
SB-L110	Approx. 1hr 40min	Approx. 1hr 30min	Approx. 2hr
SB-L220	Approx. 3hr 20min	Approx. 3hr 10min	Approx. 4hr 10min

Notes

- The battery pack should be recharged in an environment of between 32°F (0°C) and 104°F (40°C).
- The battery pack should never be charged in a room temperature that is below 32°F (0°C).
- The life and capacity of the battery pack will be reduced if it is used in temperatures below 32°F (0°C) or left in temperatures above 104°F (40°C) for a long period, even when it is fully recharged.
- Do not put the battery pack near any heat source (fire or flames, for example).
- Do not disassemble, process, pressure, or heat the Battery Pack.
- Do not allow the + and - terminals of the battery pack to be short-circuited. It may cause leakage, heat generation, induce fire and overheating.

Preparation

Battery level display

- **The battery level display indicates the amount of power remaining in the battery pack.**
 - a. Fully charged
 - b. 20~40% used
 - c. 40~80% used
 - d. 80~95% used
 - e. Completely used (flickers)
(The camcorder will turn off soon, change the battery as soon as possible)
- ⚠ Please refer to the table on page 23 for approximate continuous recording times.
- ⚠ The recording time is affected by environmental temperature and conditions.
The recording time becomes very short in a cold environment. The continuous recording times in the operating instructions are measured using a fully charged battery pack at 77°F(25°C). As the environmental temperature and conditions may differ when you actually use the camcorder, the remaining battery time may not be the same as the approximate continuous recording times given in these instructions.

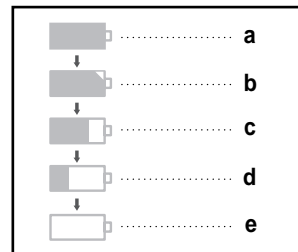

Preparation

Inserting and Ejecting a Cassette

- ⚠ There are three types of Mini DV CASSETTE tapes: DVM80, DVM60 and DVM30.
 - ⚠ When inserting a tape or closing a cassette holder, do not apply excessive force. This may cause a malfunction.
 - ⚠ Do not use any tapes other than Mini DV CASSETTES.
1. Connect a power source and slide the TAPE EJECT switch and open the cassette door.
 - The cassette holding mechanism rises automatically.
 2. When you see the writing-proof tab, insert a tape into the holder with its window panel outside.
 3. Press the area labelled PUSH on the cassette holding mechanism until it clicks into place.
 - The cassette is loaded automatically.
 4. Close the cassette door.
 - Close the door completely until you can hear a "click".

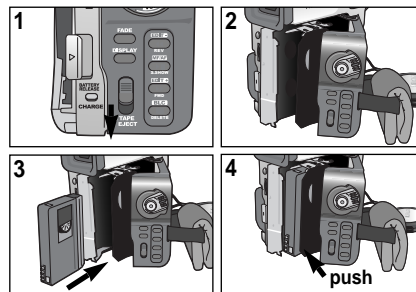

Note

- When you have recorded something that you wish to keep, you can protect it so that it will not be accidentally erased.
- a. **Protecting a tape :**
Push the safety tab on the cassette so that the hole is uncovered.
 - b. **Removing the tape protection :**
If you no longer wish to keep the recording on the cassette, push the write-protect tab back so that it covers the hole.
- **How to keep a tape**
 - a. Avoid places with magnets or magnetic interference.
 - b. Avoid humidity and dust prone places.
 - c. Keep the tape in an upright position and avoid storing it in direct sunlight.
 - d. Avoid dropping or knocking your tapes.

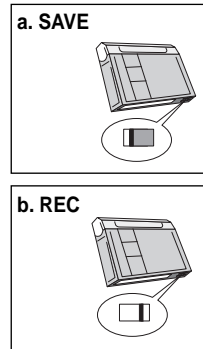

Basic Recording

Making your First Recording

1. Connect a Power source to the camcorder. (see page 21)
(A battery pack or a AC power adapter)
 - Insert a cassette. (see page 25)
2. Remove the LENS CAP and hook it onto the hand strap.
3. Set the power switch to the CAM position.
 - Open the LCD monitor and make sure that STBY is displayed.
 - If the protection tab of the cassette is open, STOP and PROTECTION! will be displayed.
 - Make sure the image you want to record appears in the LCD monitor or viewfinder.
 - Make sure the battery level indicates that there is enough remaining power for your expected recording time.
4. To start recording, press the START/STOP button.
 - REC is displayed in the LCD.
 - To stop recording, press the START/STOP button again.
 - STBY is displayed in the LCD.

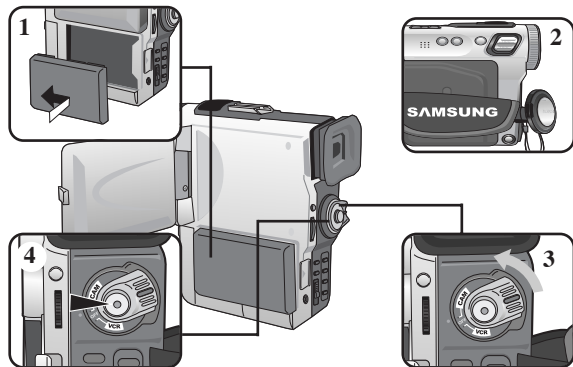

Basic Recording

When a cassette is loaded and the camcorder is left in the STBY mode for more than 5 minutes without being used, it will switch off automatically.

To use it again, push the START/STOP button or set the Power switch to OFF and then back to CAM.

This Auto Power off feature is designed to save battery power.

Edit Search

- ⌘ When the camcorder is in STBY mode, you can use record search to play the tape forwards or backwards to find the point where you want to start or resume recording.

EDIT - enables you to play the recording backwards and EDIT + enables you to play it forwards, for as long as you keep each button pressed down.

- ⌘ If you press the EDIT - button in STBY mode, your camcorder will play in reverse for 3 seconds and return to the original position automatically.

Note

- Mosaic shaped distortion may appear on the screen while in edit search mode.

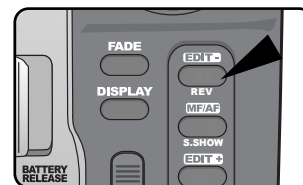
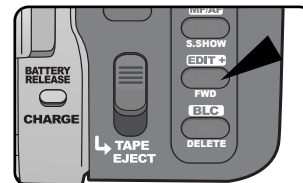

Basic Recording

Hints for Stable Image Recording

- While recording, it is very important to hold the camcorder correctly.
- Fix the LENS cap firmly by clipping it to the hand strap. (refer to the figure)

Recording with the LCD monitor

1. Hold the camcorder firmly using the hand strap.
2. Place your right elbow against your side.
3. Place your left hand under or beside the LCD to support and adjust it.
Do not touch the built-in microphone.
4. Choose a comfortable, stable position for the shots that you are taking.
You can lean against a wall or on a table for greater stability.
Do not forget to breathe gently.
5. Use the LCD frame as a guide to determine the horizontal plane.
6. Whenever possible, use a tripod.

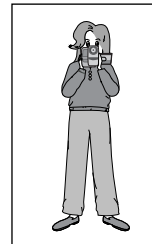

Recording with the Viewfinder

1. Hold the camcorder firmly using the hand strap.
2. Place your right elbow against your side.
3. Place your left hand under the camcorder to support it.
Be sure not to touch the built-in microphone.
4. Choose a comfortable, stable position for the shots that you are taking.
You can lean against a wall or on a table for greater stability.
Do not forget to breathe gently.
5. To view an object through the viewfinder, pull it out until you hear the 'click' sound.
Excessive force may cause damage to the viewfinder.
6. Place your eye firmly against the viewfinder eyecup.
7. Use the viewfinder frame as a guide to determine the horizontal plane.
8. Whenever possible, use a tripod.



Basic Recording

Adjusting the LCD

- ⌘ Your camcorder is equipped with a 2.5 inch colour Liquid Crystal Display(LCD) screen, which enables you to view what you are recording or playing back directly.
 - ⌘ Depending on the conditions under which you are using the camcorder (indoors or outdoors for example), you can adjust ;
 - BRIGHT SELECT
 - BRIGHT ADJUST
 - COLOUR ADJUST
1. Set the POWER switch to CAM position.
 - In the VCR mode, you may only setup the LCD while the tape is playing.
 2. Open the LCD screen, and the LCD switches on.
 3. Press the MENU button.
 4. Turn the MENU DIAL so that VIEWER is highlighted and then push the MENU DIAL.
 5. Turn the MENU DIAL so that LCD ADJUST is highlighted.
 6. Push the MENU DIAL to enter the sub-menu.
 7. Turn the MENU DIAL so that it highlights the menu item you want to adjust (BRIGHT SELECT, BRIGHT ADJUST, COLOUR ADJUST).

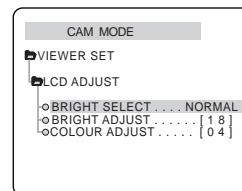
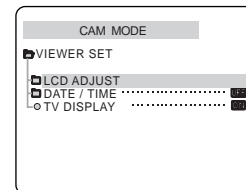
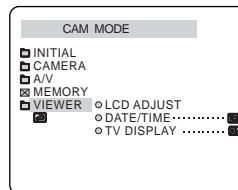
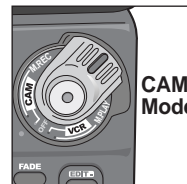

Basic Recording

8. Push the MENU DIAL again.
 - You may select NORMAL or SUPER in the BRIGHT SELECT feature and push the MENU DIAL to save the setting.
 - Use the MENU DIAL to adjust the value of BRIGHT ADJUST and COLOUR ADJUST.
 - You can set values for BRIGHT ADJUST between 00 ~ 35 and COLOUR ADJUST between 00 ~ 07.
9. Press the MENU button to finish the setting.

Using the VIEWFINDER

- ⌘ The VIEWFINDER will not work when the LCD is open.
- ⌘ In order to bring it into focus, pull the viewfinder forward until you here a click.

Adjusting the Focus

Use the focus adjustment knob of the VIEWFINDER to focus the picture. (refer to figure)

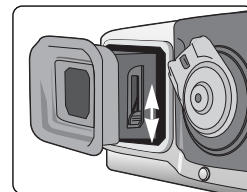
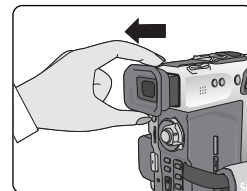

Basic Recording

Playing back a tape you have recorded on the LCD

- ⌘ You can monitor the playback picture on the LCD monitor.
- ⌘ Make sure that the battery pack is in place.

1. Hold down the Power switch tab and turn it to the VCR position.
2. Insert the tape you wish to view. (see page 25)
3. Open the LCD screen.
Adjust the angle of the LCD screen and set the brightness or colour if necessary.
4. Press the ◀◀ (REW) button to rewind the tape to the starting point.
 - To stop rewinding, press the ■ (STOP) button.
 - The camcorder stops automatically after rewinding is complete.
5. Press the ▶/|| (PLAY/STILL) button to start playback.
 - You can view the picture you recorded on the LCD.
 - To stop the PLAY operation, press the ■ (STOP) button.

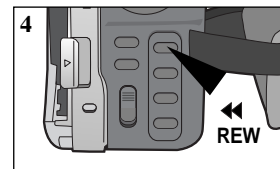
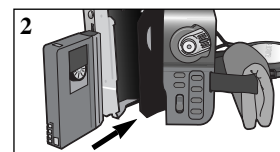
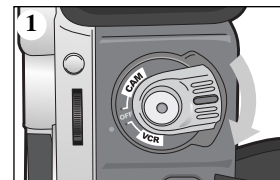

Notes

- You can also view the picture on a TV screen, after connecting the camcorder to a TV or VCR. (see page 66)
- Various functions are available in playback mode. (see page 68)

Basic Recording

Adjusting the LCD during PLAY

- ⌘ You can adjust the LCD during playback.
- ⌘ The adjustment method is the same procedure as used in CAM mode. (see page 29)

Controlling Sound from the Speaker

The Speaker works in VCR mode only.

- When you use the LCD screen for playback, you can hear the recorded sound from the built-in Speaker.
 - Follow the instructions below to decrease or mute speaker volume in the VCR mode.
 - Take the following steps to lower the volume or mute the sound while playing a tape on the VCR.
1. Set the power switch to VCR mode.
 2. Press ►/II (PLAY/STILL) to play the tape.
 3. When you hear sounds once the tape is in play, use the MENU DIAL to adjust the volume.
 - A volume level display will appear on the LCD.
 - Levels may be adjusted from anywhere between 00 to 19 and you will not hear any sound when the volume is set on 00.
 - If you close the LCD while playing, you will not hear sound from the speaker.

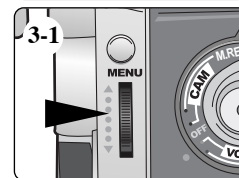
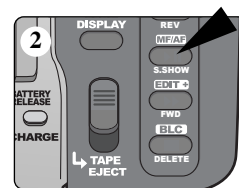

<3-2>

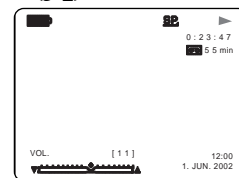

Advanced Recording

Use of various Functions

● Setting menu items

MENU	SUB MENU	MODE switch
INITIAL	CLOCK SET REMOCON BEEP SOUND SHUTTER SOUND DEMONSTRATION	C//MR/MP C//MR/MP C//MR/MP MR C
CAMERA	PROGRAM AE WHT. BALANCE D. ZOOM EIS DSE SELECT CUSTOM. Q	C/MR C/MR C/MR C/MR C/MR C/MR
AV	REC MODE PHOTO SEARCH PHOTO COPY AUDIO MODE AUDIO SELECT WIND CUT	C/V V V C/V V C/V
MEMORY	QUALITY PRINT MARK PROTECT DELETE FORMAT	V/MR MP MP MP MP
VIEWER	LCD ADJUST DATE/TIME TV DISPLAY	C//MR/MP C//MR/MP C//MR/MP

☞ C : CAM MODE

☞ V : VCR MODE

☞ MR : M.REC MODE

☞ MP : M.PLAY MODE

● Set the camcorder to CAM or VCR mode and M.REC or M.PLAY mode (VP-D380/D380i only)

1. Press the MENU button.

The MENU OSD is displayed. The cursor (**HIGHLIGHT**) indicates the feature you are currently adjusting.

2. Using the MENU DIAL and push the MENU DIAL on the rear side panel, select and activate the item.

3. You can exit the menu mode by pressing the MENU button.

Advanced Recording

● Availability of functions in each mode

Requested Mode \ Operating Mode	Digital functions			Digital special effects
	EIS	D.ZOOM	PHOTO	
EIS		○	○	○
D.ZOOM	○		○	○
PHOTO	×	×		×
Digital Special Effects	○	○	○	

○ : The requested mode will work in this operating mode.

×

Notes

- When a menu item on the LCD is marked with an X, that item cannot be activated.
- When you select an item that cannot be changed, an error message will be displayed.

● RESET

- ⚠ If you push the RESET button, the LCD MENU settings are changed to the default settings.
- ⚠ Push the RESET button by using an object with sharp point such as a small screwdriver.

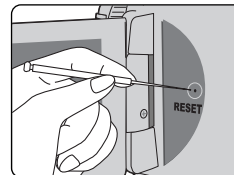

Advanced Recording

● CLOCK SET

- ⌘ CLOCK setup works in CAM, VCR, M.REC and M.PLAY modes.
- ⌘ The DATE/TIME is automatically recorded onto a tape.
Before recording, please set the DATE/TIME.

1. Press the MENU button.
 - The menu list will appear.
2. Turn the MENU DIAL to highlight INITIAL and push the MENU DIAL.
3. Use the MENU DIAL to select CLOCK SET from the submenu.
4. Push the MENU DIAL to enter SETTING mode.
 - A blinking item indicates the item to be changed. The year will blink first.
5. Using the MENU DIAL, change the year setting.
6. Push the MENU DIAL.
 - The month will blink.
7. Using the MENU DIAL, change the month setting.
8. Push the MENU DIAL.
 - The day will blink.
9. You can set the day, hour and minute following the same procedure for setting the year and month.
10. Push the MENU DIAL after setting the minutes.
 - The word COMPLETE! will appear, and a few seconds later, the menu screen will automatically return to the sub menu.
11. To exit, press the MENU button.

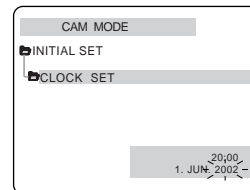
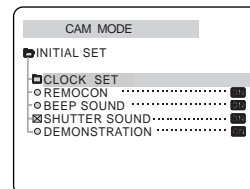
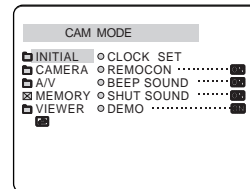

Advanced Recording

● REMOCON

- ⌘ THE REMOCON function works in CAM, VCR, M.REC, M.PLAY modes.
- ⌘ The REMOCON option allows you to enable or disable the remote control for use with the camcorder.

1. Press the MENU button.
 - The menu list will appear.
2. Turn the MENU DIAL to highlight INITIAL and push the MENU DIAL.
3. Use the MENU DIAL to select REMOCON from the submenu.
4. Push the MENU DIAL to enable or disable the remote control.
The setting switches between ON/OFF each time you push the MENU DIAL.
5. To exit, press the MENU button.
 - If you set the remote to OFF in the menu and try to use it, the remote icon will blink on the LCD for 3 seconds, then disappear.

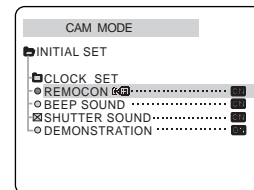
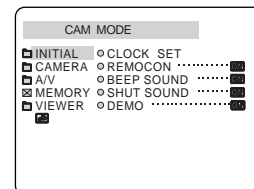

Advanced Recording

● BEEP SOUND

- ⌘ THE BEEP SOUND function works in CAM, VCR, M.REC, M.PLAY modes.
- ⌘ Use the MENU to setup the BEEP SOUND function. Select whether or not you want to hear a beep sound whenever you change a setup value.

1. Press the MENU button.
 - The menu list will appear.
2. Turn the MENU DIAL to highlight INITIAL and push the MENU DIAL.
3. Use the MENU DIAL to select BEEP SOUND from the submenu.
4. Push the MENU DIAL to enable or disable the BEEP SOUND.
The setting switches between ON/OFF each time you push the MENU DIAL.
 - When you press the START / STOP button to start a recording, the BEEP SOUND is automatically OFF.
5. To exit, press the MENU button.

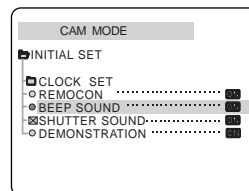
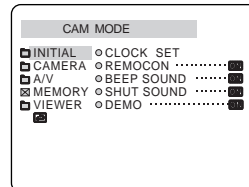

Advanced Recording

● SHUTTER SOUND

- ⌘ You can hear the SHUTTER SOUND only when using the PHOTO function.
- ⌘ Determines whether or not you wish to hear a SHUTTER SOUND when using the DSC feature.

1. Set the camcorder to M.REC mode.
2. Press the MENU button.
 - The menu list will appear.
3. Turn the MENU DIAL to highlight INITIAL and push the MENU DIAL.
4. Use the MENU DIAL to select SHUTTER SOUND from the submenu.
5. Push the MENU DIAL to switch between ON and OFF.
6. To exit, press the MENU button.

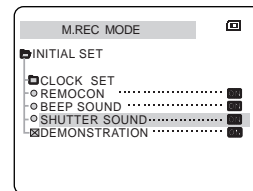
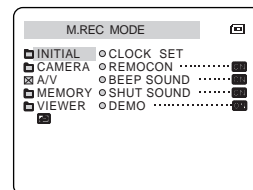

Advanced Recording

● DEMONSTRATION

- ⌘ Demonstration automatically shows you the major functions that are included with your camcorder so that you may use them more easily.
- ⌘ The DEMONSTRATION function may only be used in the CAM mode without a tape inserted in the camcorder.
- ⌘ The demonstration operates repeatedly until the DEMONSTRATION mode switched OFF.

1. Set the camcorder to CAM mode.
2. Press the MENU button.
 - The menu list will appear.
3. Turn the MENU DIAL to highlight INITIAL.
4. Select DEMONSTRATION from the submenu and push the MENU DIAL.
5. To activate the DEMONSTRATION, set DEMONSTRATION ON.
 - Press the menu button to quit the menu.
 - The demonstration will begin.
6. To end the DEMONSTRATION, set the DEMONSTRATION to OFF.

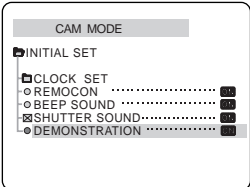
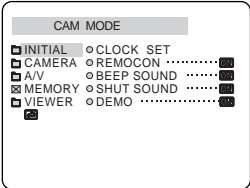

Notes

- The DEMONSTRATION function only works without a TAPE installed.
- The DEMONSTRATION mode is automatically activated when the camcorder is left idle for more than 10 minutes after switching to the CAM mode (when the tape is not inserted in the camcorder).
- If you press other buttons (FADE, BLC, PHOTO, EASY, CUSTOM) during the DEMONSTRATION mode, the DEMONSTRATION stops temporarily and resumes 10 minutes later if you do not operate any other functions.

Advanced Recording

● PROGRAM AE

- ⌘ The PROGRAM AE function works in CAM or M.REC mode only.
- ⌘ The PROGRAM AE mode allows you to adjust shutter speeds and apertures to suit different recording conditions.
- ⌘ The modes you creative control over the depth of field.

■ AUTO mode

- Auto balance between the subject and the background.
- To be used in normal conditions.
- The shutter speed automatically varies from 1/50 to 1/250 per second, depending on the scene.

■ SPORTS mode (⌘)

- For recording people or objects moving quickly.

■ PORTRAIT mode (⌘)

- For focusing on the background of the subject, when the background is out of focus.
- The PORTRAIT mode is most effective when used outdoors.
- The shutter speed automatically varies from 1/50 to 1/1000 per second.

■ SPOTLIGHT mode (⌘)

- For recording correctly when there is only light on the subject and not the rest of the picture.

■ SAND/SNOW mode (⌘)

- For recording when people or objects are darker than the background because of reflected light from sand or snow.

■ HSS (High Shutter Speed) mode (⌘)

- For recording fast-moving subjects such as players in golf or tennis games.

Advanced Recording

Setting the PROGRAM AE

1. Press the MENU button.
 - The menu list will appear.
2. Turn the MENU DIAL to highlight CAMERA and push the MENU DIAL.
3. Select PROGRAM AE from the sub menu.
4. Push the MENU DIAL to enter the sub menu.
5. Using the MENU DIAL, select the PROGRAM AE mode.
 - Push the MENU DIAL to confirm the PROGRAM AE mode.
6. To exit, press the MENU button.

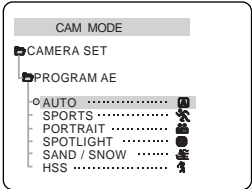
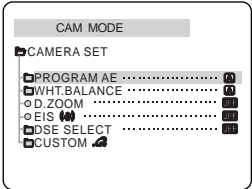
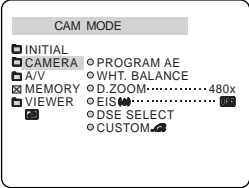

Advanced Recording

● WHT. BALANCE (WHITE BALANCE)

- ⚙ The WHITE BALANCE function works in CAM or M.REC mode only.
 - ⚙ The WHITE BALANCE is a recording function that preserves the unique colour of the object in any recording condition.
 - ⚙ You may select the appropriate WHITE BALANCE mode to obtain good quality colour of the image.
- AUTO (☒) : This mode is generally used to control the WHITE BALANCE automatically.
 - HOLD (⬇) : This fixes the current WHITE BALANCE value.
 - INDOOR (☼) : This controls the WHITE BALANCE according to the indoor ambience.
 - OUTDOOR (☼) : This controls the WHITE BALANCE according to the outdoor ambience.

1. Set the camcorder to CAM mode.
2. Press the MENU button.
 - The menu list will appear.
3. Turn the MENU DIAL to highlight CAMERA and push the MENU DIAL.
4. Select WHT.BALANCE from the sub menu.
5. Push the MENU DIAL to enter the sub menu.
6. Using the MENU DIAL, select the WHITE BALANCE mode.
 - Push the MENU DIAL to confirm the WHITE BALANCE mode.
7. To exit, press the MENU button.

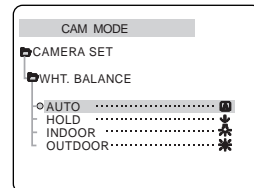
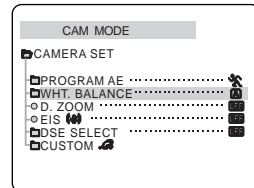
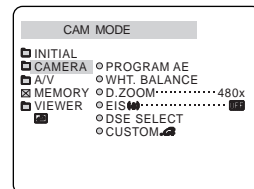

Advanced Recording

Zooming In and Out with DIGITAL ZOOM

- ⌘ Zoom works in CAM/M.REC mode only.

Zooming In and Out

- ⌘ The VP-D340/D340i/D380/D380i model offers a DUAL Zoom system for added convenience.
- ⌘ Zooming is a recording technique that lets you change the size of the subject in a scene. For more professional looking recordings, do not use the zoom function too often.
- ⌘ You can zoom using variable zoom speeds.
- ⌘ Use these features for different shots. Please note that over-use of the zoom feature can lead to unprofessional looking results and a reduction of battery usage time.
- ⌘ The dual zoom lever has the same function of the normal zoom lever but takes more time for zooming in and out. It is useful to use the dual zoom lever when you need a detailed zooming in and out.

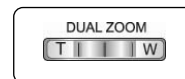

1. Move the zoom lever slightly for a gradual zoom, move it further for a high-speed zoom. Your zooming is monitored on the OSD.
2. T(Telephoto) side: Subject appears closer.
3. W(Wide angle) side: Subject appears farther away.

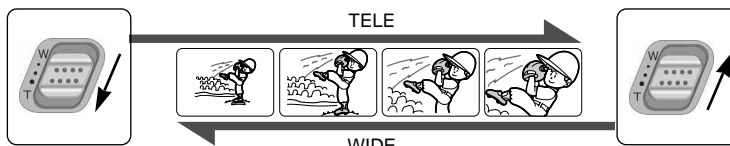

Note

- You can record a subject that is a minimum of 1 m (about 2.65 feet) away from the lens surface in the TELE position, or about 10 mm (about 0.5 inch) away in the WIDE position.

Advanced Recording

Digital Zoom

- ⌘ Zooms more than 12x are performed digitally.
- ⌘ The picture quality may deteriorate depending on how much you zoom in on the subject.
- ⌘ We recommend that you use the EIS feature with DIGITAL ZOOM for picture stability. (see page 45)

1. Set the camcorder to CAM or M.REC mode.
2. Press the MENU button.
 - The menu list will appear.
3. Turn the MENU DIAL to CAMERA and push the MENU DIAL.
4. Select D.ZOOM from the submenu.
5. Push the MENU DIAL to setup the 480x digital zoom function or to turn the feature OFF.
6. To exit, press the MENU button.

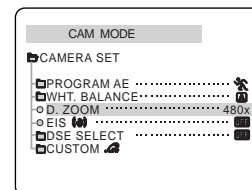
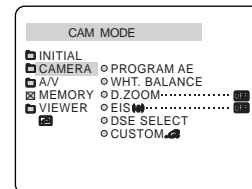

Advanced Recording

● EIS (Electronic Image Stabilizer)

- ⌘ The EIS function works in CAM/M.REC mode only.
- ⌘ EIS(Electronic Image Stabilizer) is a function that compensates for any shaking or hand movement while holding the camcorder (within reasonable limits).
- ⌘ It provides more stable pictures when:
 - Recording a small object close-up
 - Recording and walking at the same time
 - Recording through the window of a vehicle

1. Set the camcorder to CAM mode.
2. Press the MENU button.
 - The menu list will appear.
3. Turn the MENU DIAL highlight to CAMERA and push the MENU DIAL.
 - The sub menu list will appear.
4. Turn the MENU DIAL to activate the EIS function, push the MENU DIAL.
 - The EIS menu is changed to ON.
 - If you do not want to use the EIS function, set the EIS menu to OFF.
5. To exit, press the MENU button.

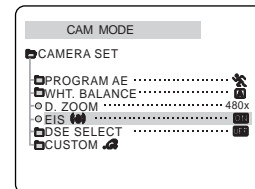
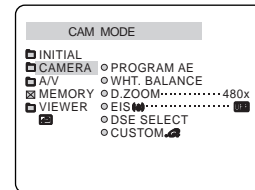

Note

- It is recommended that you deactivate the shake compensation function when using a tripod.

Advanced Recording

● DSE (Digital Special Effects) SELECT

- ⌘ The DSE function works in CAM and M.REC mode only.
- ⌘ The digital effects enable you to give a creative look to your recording by adding various special effects.
- ⌘ Select the appropriate digital effect for the type of picture that you wish to record and the effect you wish to create.
- ⌘ There are 9 DSE modes.

- a. ART mode
This mode gives the images a coarse effect.
- b. MOSAIC mode
This mode gives the images a mosaic effect.
- c. SEPIA mode
This mode gives the images a reddish-brown pigment.
- d. NEGA mode
This mode reverses the colours of the images creating a negative image.
- e. MIRROR mode
This mode cuts the picture in half, using a mirror effect.
- f. BLK & WHT mode
This mode changes the images to black and white.
- g. EMBOSS mode
This mode creates a 3D effect (embossing).
- h. CINEMA mode
This mode covers the upper/lower portions of the screen to give a cinematic effect.
- i. MAKE - UP mode
This mode allows the images to be selected in red, green, blue or yellow colours.

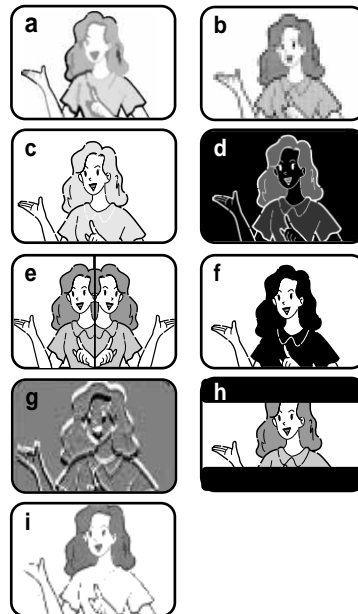

Advanced Recording

Selecting an effect

1. Set the camcorder to CAM mode.
2. Press the MENU button.
 - The menu list will appear.
3. Turn the MENU DIAL to highlight CAMERA and push the MENU DIAL.
4. Select DSE SELECT from the sub menu.
5. Push the MENU DIAL to enter the sub menu.
6. Using MENU DIAL, select the DSE mode.
 - Push the MENU DIAL to confirm the DSE mode.
7. To exit, press the MENU button.

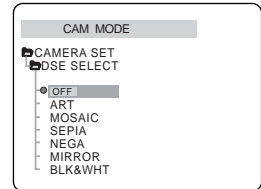
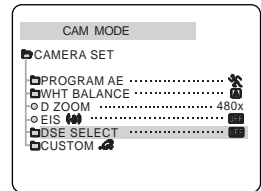
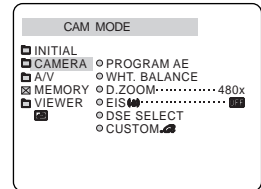

Advanced Recording

● CUSTOM.Q

⚠ You can customize settings and save them for future use.

■ The CUSTOM.Q function operates in the CAM and M.REC mode.

⚠ If you want to use the CUSTOM.Q function (see page 58) correctly, set the status of each item as desired before using the CUSTOM.Q function.

⚠ You can set and store the following items:

■ PROGRAM AE, WHT.BALANCE, D.ZOOM, EIS, DSE SELECT

1. Set the power switch to CAM mode.
2. Press the MENU button.
 - The MENU list will appear.
3. Turn the MENU DIAL, select CAMERA position and push the MENU DIAL.
4. Select CUSTOM.Q using MENU DIAL in the submenu and push the MENU DIAL.
5. Using and pushing the MENU DIAL and push the MENU DIAL, set the status of each item as desired.
6. To exit the menu, press the MENU button.

Note

■ If you want to activate the CUSTOM.Q function, press the CUSTOM.Q button while in CAM mode.

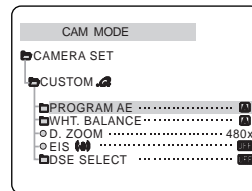
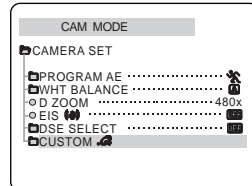
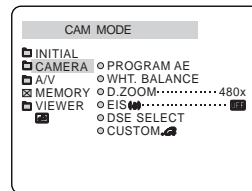

Advanced Recording

● REC MODE

- ⌘ The REC MODE function works in both CAM and VCR modes.
- ⌘ This camcorder records and plays back in SP (standard play) mode and in LP (long play) mode.
 - SP (standard play): This mode permits 60 minutes of recording time with a DVM60 tape.
 - LP (long play): This mode permits 90 minutes of recording time with a DVM60 tape.

1. Set the camcorder to CAM or VCR mode.
2. Press the MENU button.
 - The menu list will appear.
3. Turn the MENU DIAL to highlight A/V and push the MENU DIAL.
4. Select REC MODE from the submenu and push the MENU DIAL.
 - The REC MODE toggles between SP and LP with each push.
5. To exit, press the MENU button.

Notes

- We recommend that you use this camcorder to play back any tapes recorded on this camcorder. Playing back a tape recorded in other equipment may produce mosaic shaped distortion.
- Record using SP mode for best picture and sound quality.

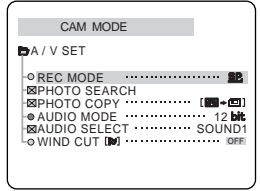
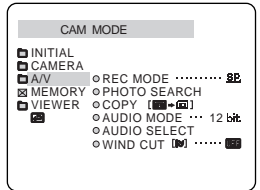

Advanced Recording

● AUDIO MODE

- ⌘ The AUDIO MODE function works in CAM and VCR modes.
- ⌘ This camcorder can record sound on a tape in two audio modes (12 bit, 16 bit).
 - 12bit : You can record two 12bit stereo sound tracks.
The original stereo sound can be recorded onto the MAIN (SOUND1) track.
Additional stereo sound can be dubbed onto the SUB (SOUND2) track.
 - 16bit : You can record one high quality stereo sound using the 16bit recording mode.
Audio dubbing is not possible when using this mode.

1. Set the camcorder to CAM mode.
2. Press the MENU button.
 - The menu list will appear.
3. Turn the MENU DIAL to highlight A/V and push the MENU DIAL.
4. Select the AUDIO MODE from the menu and push the MENU DIAL.
 - The AUDIO MODE toggles between 12bit-16bit with each push.
5. To exit, press the MENU button.

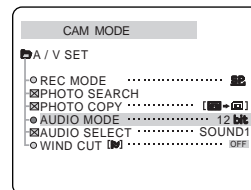
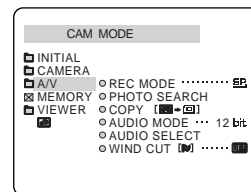

Advanced Recording

● WIND CUT

- ⌘ The WIND CUT function works in CAM and VCR modes.
- ⌘ The WIND CUT function minimizes wind noise or other noise while recording.
 - When the wind cut is on, some low sounds are eliminated along with the sound of the wind.

1. Set the camcorder to CAM mode.
2. Press the MENU button.
 - The menu list will appear.
3. Turn the MENU DIAL to highlight A/V and push the MENU DIAL.
4. Select WIND CUT from submenu.
5. This feature toggles ON/OFF each time you push the MENU DIAL.
 - [W] is shown in the display when you turn the WIND CUT on.
6. To exit, press the MENU button.

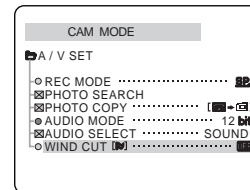
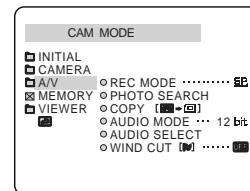

Notes

- Make sure WIND CUT is set to off when you want the microphone to be as sensitive as possible.
- Use the WIND CUT when recording in windy places such as the beach or near buildings.

Advanced Recording

● DATE/TIME

- ⌘ The DATE/TIME function works in CAM, VCR, M.REC and M.PLAY modes.
- ⌘ The date and time are automatically recorded on a special data area of the tape.

1. Press the MENU button.
 - The menu list will appear.
2. Turn the MENU DIAL to highlight VIEWER and push the MENU DIAL.
3. Turn the MENU DIAL to highlight DATE/TIME.
4. Push the MENU DIAL to select the sub-menu.
5. Using the MENU DIAL, select the DATE/TIME mode.
 - ⌘ You can choose between - the OFF, DATE, TIME and DATE/TIME modes
 - OFF only
 - DATE only
 - TIME only
 - DATE & TIME
 - ⌘ To return to the previous menu, highlight DATE/TIME in the middle of the menu and push MENU DIAL.
6. To exit, press the MENU button.

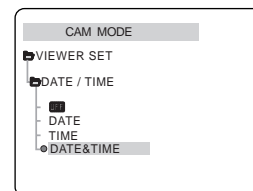
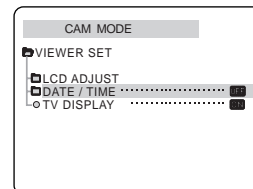
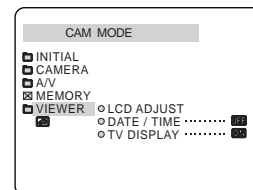

Notes

- The DATE/TIME is not affected by the OSD ON/OFF (DISPLAY) button.
- The DATE/TIME will read “- -” in the following conditions.
 - During playback of a blank section of a tape.
 - If the tape was recorded before setting the DATE/TIME in the Camera's memory.
 - When the battery becomes weak or dead.
- Before you can use the DATE/TIME function, you must set the Clock.

Advanced Recording

TV DISPLAY



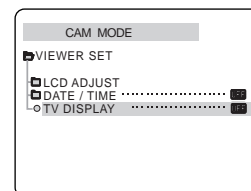
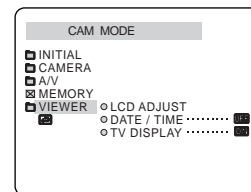

- ⌘ The TV DISPLAY function works in CAM, VCR, M.REC, M.PLAY modes.
- ⌘ You can select the output path of the OSD (On Screen Display).
 - OFF: The OSD appears in the LCD screen only.
 - ON: The OSD appears in the LCD screen, CVF and TV hooked up to the camcorder.
 - Use the DISPLAY button located at the rear of the camcorder to turn ON/OFF all of the OSD displayed on the LCD/CVF/TV.

1. Set the camcorder to CAM, VCR, M.REC, M.PLAY mode.
2. Press the MENU button.
 - The menu list will appear.
3. Turn the MENU DIAL to highlight VIEWER and push the MENU DIAL.
4. Select the TV DISPLAY mode in list, push the MENU DIAL.
 - The DISPLAY mode switches between ON/OFF with each push.
5. To exit, press the MENU button.



Advanced Recording

Using Quick Menu

- ⌘ Quick menu is available only in CAM or M.REC mode.
- ⌘ Quick menu is used to adjust camera functions by simply using the MENU DIAL.
This feature is useful for when you want to make simple adjustments without having to access the menus and submenus.
- **DATE/TIME**
 - Each time you select DATE/TIME and press the MENU DIAL, it'll be displayed in the order of DATE - TIME - DATE/TIME - OFF(See page 52).
- **REMOCON**()
 - Each time you select REMOCON and press the MENU DIAL, the REMOCON is switched to either enabled () or disabled () .
- **EIS**()
 - Each time you select EIS and press the MENU DIAL, the EIS icon is displayed or set to OFF.
- **DSE(Digital Special Effect) (see page 46)**
 - Each time you select DSE and press the MENU DIAL, the DSE preset values are applied or set to OFF. DSE values will not switch between On and Off if they have not been preset in the menu.
- **PROGRAM AE (see page 40)**
 - Each time you select PROGRAM AE and press the MENU DIAL, you can choose between the preset PROGRAM AE values and AUTO. You can't choose between Auto and the PROGRAM AE values if the values have not been preset in the regular menu.

Advanced Recording

■ WHT. BALANCE(see page 42)

- Each time you select WHT. BALANCE and press the MENU DIAL, you can choose between preset WHT.BALANCE values and AUTO. As in PROGRAM AE, you can't choose between Auto and WHT.BALANCE values if they have not been preset.

■ SHUTTER SPEED & EXPOSURE



- You can set values for SHUTTER SPEED and EXPOSURE by selecting () icon and pressing the MENU DIAL. For more information, see the next chapter.

Setting the Quick menu

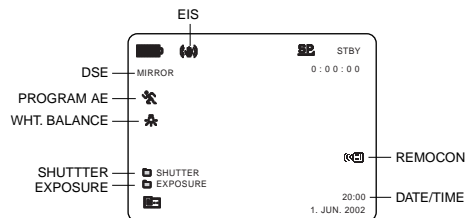
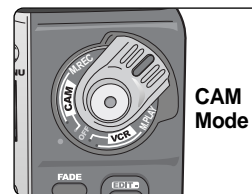
1. Set the camcorder to CAM mode.
2. Turn the MENU DIAL.
 - You'll see the WHT.BALANCE icon first.
3. Turn the MENU DIAL to select a function you want and then press the MENU DIAL to change the values.





Notes

- Quick menu function will not operate in EASY mode.
- If you are using the M.FOCUS () function, you cannot use the Quick menu. If you want to use the Quick menu function, release the M.FOCUS () mode.

Advanced Recording

SHUTTER SPEED & EXPOSURE

- ⌘ You can set SHUTTER SPEED and EXPOSURE only in CAM/M.REC mode.
- ⌘ SHUTTER SPEED and EXPOSURE values can only be set in the Quick Menu.
- ⌘ SHUTTER SPEED and EXPOSURE are automatically switched and/or deactivated.

1. Set the power switch to CAM mode.
2. Turn the MENU DIAL until you see  icon on, and then press the MENU DIAL.
 - You see a screen on which you can select SHUTTER SPEED and EXPOSURE.
 - Turn the MENU DIAL to select the item you want and then press the MENU DIAL.
 - SHUTTER SPEED can be set to 1/50, 1/120, 1/250, 1/500, 1/1000, 1/2000, 1/4000 or 1/10000.
 - EXPOSURE can be set between 00 and 29 by turning the Menu dial.
3. To exit from the setting screen, select the  icon and press the MENU DIAL.

Recommended Shutter speeds when recording

- ⌘ Outdoor sports such as golf or tennis: 1/2000 or 1/4000.
- ⌘ Moving cars or trains or other rapidly moving vehicles such as roller coasters: 1/1000, 1/500 or 1/250.
- ⌘ Indoor sports such as basketball: 1/120.

Notes

- If you want to use the selected shutter speed and exposure value, you should begin the recording with the shutter speed and the exposure adjustment screens displayed on the LCD.
- If you manually change the shutter speed and the exposure value when Auto-exposure option is selected, manual changes are applied first.
- The image may not appear smooth when a high shutter speed is set.

Advanced Recording

EASY Mode (for Beginners)

- ⌘ The EASY mode allows a beginner to make good recordings easily.
 - The EASY mode operates in CAM and M.REC mode.
1. Set the power switch to CAM mode.
 2. By pressing the EASY button, all functions on the camera will be set to off and the recording settings will be set to the following basic modes:
 - Battery level, recording mode, counter, DATE/TIME, and EIS () will be displayed.
 - The word "EASY.Q" will appear on the LCD at the same time.
 - However, the DATE/TIME will only be seen if it has been previously set. (see page 52)
 3. Press START/STOP to start recording.
 - Recording will begin using the basic automatic settings.
 4. Pressing the EASY button again turns the EASY mode off.
 - The camera will return to the settings that were set prior to activating EASY mode.

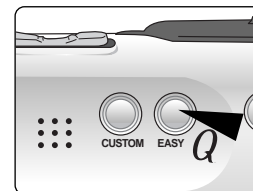

Notes

- In EASY mode, certain functions are not available, such as MENU, BLC, MF/AF.
 - If you want to use these functions, you must first switch the EASY mode off.
- The EASY mode settings are deleted when the battery pack is uninstalled from the camcorder and therefore, they must be reset when a battery pack has been replaced.

Advanced Recording

CUSTOM Mode

- ⌘ You can customize settings and save them for future use.
 - The CUSTOM SET function operates in CAM and M.REC mode only.
- ⌘ Please set the custom settings before using this function. (see page 48)

1. Set the power switch to CAM mode.
2. To activate the CUSTOM function, press the CUSTOM button.
 - "CUSTOM.Q" will be displayed on the screen.
3. Press START/STOP to start recording.
 - Recording will begin using the CUSTOM settings.
4. To switch CUSTOM mode off, press the CUSTOM button again.
 - The camcorder will revert to the settings that were set prior to custom mode being selected.

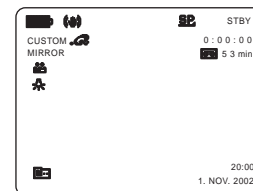
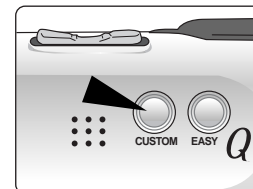

Note

- The CUSTOM mode settings are deleted when a battery pack is removed and therefore must be reset when a battery pack has been replaced.

Advanced Recording

MF/AF (Manual Focus/Auto Focus)

- ⌘ The MF/AF function works in CAM and M.REC mode only.
- ⌘ In most situations, it is better to use the automatic focus feature, as it enables you to concentrate on the creative side of your recording.
- ⌘ Manual focusing may be necessary under certain conditions that make automatic focusing difficult and/or unreliable.

Auto Focusing

- ⌘ If you are inexperienced in the use of camcorders, we recommend that you use Auto Focus.

Manual Focusing

- ⌘ In the following cases, you may obtain better results by adjusting the focus manually.
 - a. A picture containing several objects, some close to the camcorder, others further away.
 - b. A person enveloped in fog or surrounded by snow.
 - c. Very shiny or glossy surfaces like a car.
 - d. People or objects moving constantly or quickly like an athlete or a crowd.
1. Set the power switch to CAM mode.
 2. Press the MF/AF (▶/||) button.
 3. Turn the MENU DIAL up or down until the object is in focus.
 - Zoom out a little if focusing is difficult.
 4. To return to AF(Auto Focus), press the MF/AF button again.

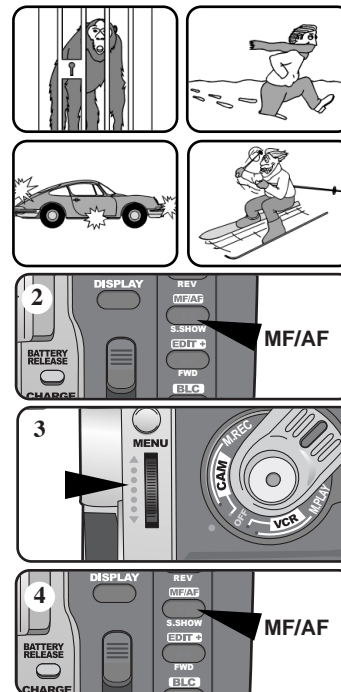

Advanced Recording

BLC (Back Light Compensation)

- ⌘ BLC works in CAM/M.REC mode.
- ⌘ Back lighting exists when the subject is darker than the background:
 - The subject is in front of a window.
 - The person to be recorded is wearing white or shiny clothes and is placed against a bright background; the person's face is too dark to distinguish his/her features.
 - The subject is outdoors and the background is overcast.
 - The light sources are too bright.
 - The subject is against a snowy background.

1. Set the power switch to CAM mode.
2. Press the BLC button.
 - Normal - BLC - Normal
 - BLC enhances the subject.

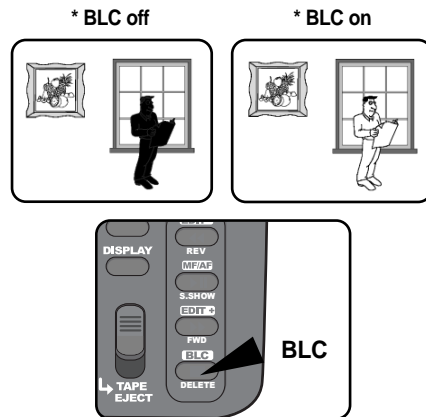

Note

- The BLC function will not operate in EASY mode.

Advanced Recording

Fade In and Out

- ⌘ The FADE function works in CAM mode only.
- ⌘ You can give your recordings a professional look by using special effects such as fading in at the beginning of a sequence or fading out at the end of a sequence.

To Start Recording

1. Before recording, hold down the FADE button. The picture and sound gradually disappear (fade out).
2. Press the START/STOP button and at the same time release the FADE button. Recording starts and the picture and sound gradually appear (fade in).

To Stop Recording (use FADE IN / FADE OUT)

3. When you wish to stop recording, hold down the FADE button. The picture and sound gradually disappear (fade out).
4. When the picture has disappeared, press the START/STOP button to stop recording.

a. **FADE OUT** (Approx. 4 seconds)

b. **FADE IN** (Approx. 4 seconds)

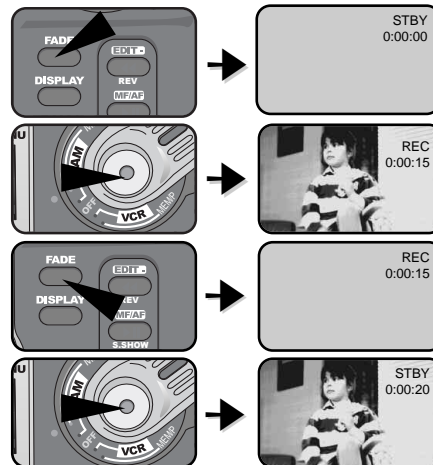

Press the FADE button a. FADE OUT Gradual disappearance



Gradual appearance b. FADE IN Release the FADE button

Advanced Recording

Audio dubbing

- ⚠ The AUDIO DUBBING function only works in VCR Mode.
- ⚠ You can add sound to the original sound on a pre-recorded tape, recorded in SP mode with 12bit sound.
- ⚠ Use the internal and external microphones or other audio equipment.
- ⚠ The original sound will not be erased.

Dubbing Sound

1. Set the camcorder to VCR mode.
 - If you want to use an external microphone, connect the microphone to the external MIC input jack on the camcorder.
 - When you wish to dub using the External A/V input, connect the AUDIO /VIDEO cable to the camcorder by inserting the cable jack into the A/V in/out terminal on the left side of the camcorder.
2. Press the ►/II (PLAY/STILL) button and find the time frame of the scene to be dubbed.
3. Press the ►/II (PLAY/STILL) button to pause the scene.
4. Press the A.DUB button on the Remote Control.
 - A.DUB will be displayed on the LCD.
 - The camcorder is in a ready-to-dub state.
5. Press the ►/II (PLAY/STILL) button to start dubbing.
 - Press the ■ (STOP) button to stop the dubbing.

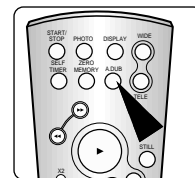
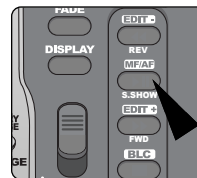
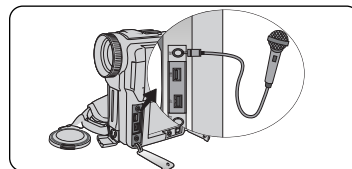

Notes

- You can not use the audio dubbing function while playing a write protected video tape.
- When you wish to dub using the External A/V input, you must connect the AUDIO/VIDEO cable to the audio system from which you wish to record.
- You can not use the audio dubbing function while the A/V cable is connected to TV.
- You can not dub sound on a pre-recorded tape in LP mode or 16 bit mode.

Advanced Recording

Dubbed audio Playback

1. Insert the dubbed tape and press MENU button.
2. Turn the MENU DIAL to highlight A/V.
3. Push the MENU DIAL to enter the sub-menu.
4. Use the MENU DIAL to select AUDIO SELECT from the submenu.
5. Push the MENU DIAL to enter the sub-menu.
6. Using the MENU DIAL, select the AUDIO playback channel.
 - Push the MENU DIAL to confirm the audio playback channel.
 - SOUND1 : play the original sound.
 - SOUND2 : play the dubbed sound.
 - MIX(1+2) : play back SOUND1 and 2 equally mixed.
7. To exit, press the MENU button.
8. Press the ►/|| (PLAY/STILL) button to playback the dubbed tape.

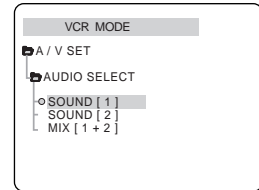
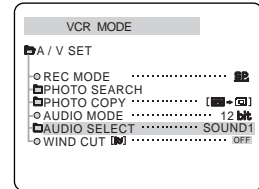

Note

- When you play back added sound (SOUND2 or MIX mode), you may experience loss of sound quality.

Advanced Recording

PHOTO Image Recording

- Press the PHOTO Button lightly (about halfway down) and hold it.
 - The still picture appears on the LCD monitor.
 - If you do not wish to record, simply release the pressure from the button.
- Press the PHOTO button fully down.
 - The still picture is recorded for about 6~7 seconds.
- After the PHOTO has been recorded, the camcorder returns to STBY mode.

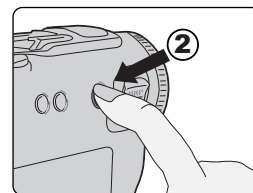
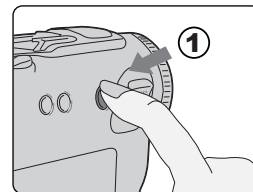

Searching for a PHOTO picture

- You can search for the recorded still image recorded on tape.
- The PHOTO SEARCH works in VCR mode only.

- Press the MENU button.
 - The menu list will appear.
- Turn the MENU DIAL to highlight A/V.
- Push the MENU DIAL to enter the sub-menu.
- Select PHOTO SEARCH from the submenu and push the MENU DIAL.
- Search the PHOTO using the ►► (FWD) and ◀◀ (REW) buttons.
 - The PHOTO search process appears on the LCD while you are searching.
 - After completing the search, the camcorder displays the still image.
- To exit, press the ■ (STOP) button.

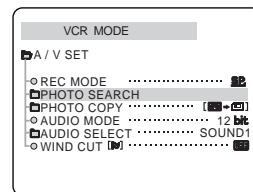
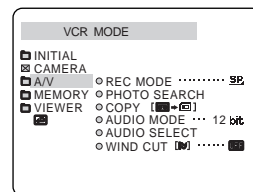

Advanced Recording

Various Recording Techniques

⌘ In some situations different recording techniques may be required for more dramatic results.

Note

- Please rotate the LCD screen carefully as excessive rotation may cause damage to the inside of the hinge that connects the LCD screen to the Camcorder.

1. General recording.

2. Downward recording.

Making a recording with a top view of the LCD screen.

3. Upward recording.

Making a recording viewing the LCD screen from below.

4. Self recording.

Making a recording viewing the LCD screen from the front.

5. Recording with the Viewfinder.

In circumstances where it is difficult to use the LCD monitor, the viewfinder can be used as a convenient alternative.

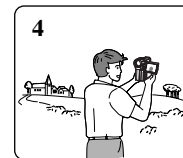
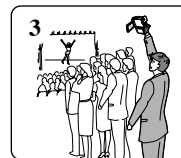
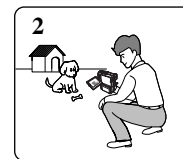

Advanced Recording

Tape Playback

⌘ The playback function works in VCR mode only.

Playback on the LCD

⌘ It is practical to view a tape using the LCD in a car or outdoors.

Playback on a TV monitor

⌘ To play back a tape, the television must have a compatible colour system.

⌘ We recommend that you use the AC Power Adapter as the power source for the camcorder.

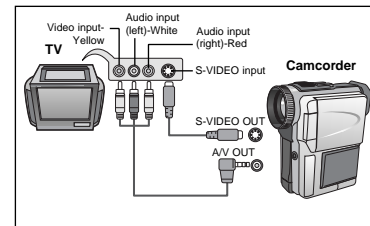

Connecting to a TV which has Audio/Video input jacks

1. Connect the camcorder and TV with the Audio/Video cable.
 - The yellow plug : Video
 - The white plug : Audio(L)
 - The red plug : Audio(R) - STEREO only
 - If you connect to a monaural TV or VCR, connect the yellow plug (Video) to the video input of the TV or VCR and the white plug (Audio L) to the audio input of the TV or VCR.
- ⌘ You may use the supplied SCART adapter.
2. Set the power switch on the camcorder to VCR mode.
3. Turn on the TV and set the TV/VIDEO selector on the TV to VIDEO.
 - Refer to the TV or VCR user's manual.
4. Play the tape back.

Notes

- You may use the S-VIDEO cable to obtain better quality pictures if you have an S-VIDEO connector on your TV.

Advanced Recording

Connecting to a VCR

- ⚠ You can connect your camcorder to a TV which has no Audio and Video input jacks through a VCR.
1. Connect the camcorder and VCR with the Audio/Video cable.
 - The yellow plug : Video
 - The white plug : Audio(L)
 - The red plug : Audio(R) - STEREO only
 2. Connect a TV to the VCR.
 3. Set the power switch on the camcorder to VCR mode.
 4. Turn on both the TV and VCR.
 - Set the input selector on the VCR to LINE.
 - Select the channel reserved for your VCR on the TV set.
 5. Play the tape back.

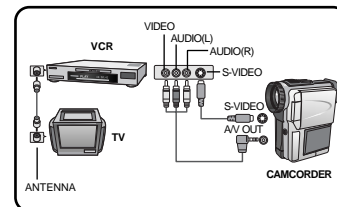

Playback

- ⚠ You can play the recorded tape in VCR mode.
1. Connect a power source and set the power switch to VCR mode.
 2. Insert the tape you wish to play back.
 3. Using the ►► (FWD) and ◀◀ (REW) buttons, find the first position you wish to play back.
 4. Press the ►/|| (PLAY/STILL) button.
 - The images you recorded will appear on the TV after a few seconds.
 - If a tape reaches its end while being played back, the tape will rewind automatically.

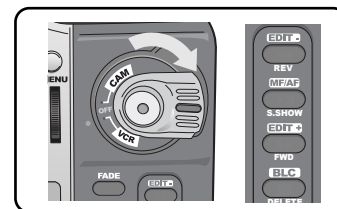

Notes

- It is best to decrease the volume of the built-in speaker when your camcorder is connected to the TV.
- The playback mode (SP/LP) is selected automatically.

Advanced Recording

Various Functions while in VCR mode

- ⌘ The PLAY/STILL, STOP, FWD, REW buttons are located on the camcorder and the Remote Control.
- ⌘ The F.ADV(Frame advance), X2, SLOW buttons are located on the Remote Control only.
- ⌘ To prevent tape and head-drum wear, your camcorder will automatically stop if it is left in STILL or SLOW modes for more than 5 minutes.

Playback pause

- ⌘ Press the ►/|| (PLAY/STILL) button during Playback or Slow playback.
- ⌘ To resume playback, press the ►/|| (PLAY/STILL) button.

Picture search (Forward/Reverse)

- ⌘ Press the ►► (FWD) or ◀◀ (REW) buttons once during Playback , Slow mode or Still mode.
To resume normal playback, press the ►/|| (PLAY/STILL) button.
- ⌘ Keep pressing ►► (FWD) or ◀◀ (REW) buttons during Playback mode.
To resume normal playback, release the button.

Slow playback (Forward/Reverse)

- ⌘ Forward Slow Playback
 - Press the SLOW button on the Remote Control during Playback.
 - To resume normal playback, press the ►/|| (PLAY/STILL) button.
- ⌘ Reverse slow playback
 - Press the ◀◀ (REW) button during Forward Slow Play back.
 - To resume forward slow playback, press the ►► (FWD) button.
 - To resume normal playback, press the ►/|| (PLAY/STILL) button.

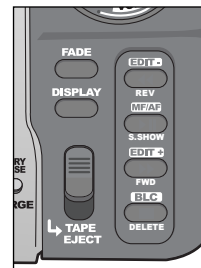

Advanced Recording

ZERO MEMORY

- ⌘ The MEMORY function works in both CAM and VCR modes.
 - ⌘ You can mark a point on a tape that you want to return to following playback.
1. Press the ZERO MEMORY button on the Remote Control during playback or recording at the point you wish to return to.
 - The time code is changed to a tape counter that is set to zero memory with the **M** 0:00:00(Zero memory indicator)
 - If you want to cancel the zero memory function, press the ZERO MEMORY button again.
 2. Finding the zero position.
 - When you have finished playback, fast forward or rewind the tape.
 - The tape stops automatically when it reaches the zero position.
 - When you have finished recording, press the power switch on the VCR and press the **◀** (REW) button.
 - The tape stops automatically when it reaches the zero position.
 3. The tape counter with the **M** (Zero memory indicator) disappears from the display and the tape counter is changed to the time code.

Notes

- In the following situations, ZERO MEMORY mode may be canceled automatically
 - At the end of the section marked with the ZERO MEMORY function.
 - When the tape is ejected.
 - When you remove the battery pack or power supply.
- The zero memory may not function correctly where there is a break between recordings on the tape.
- The ZERO MEMORY will not operate in DV IN mode.

IEEE 1394 Data Transfer

Transferring IEEE1394 (i.LINK)-DV standard data connections

Connecting to a DV device

- ⌘ Connecting with other DV standard products.
 - A standard DV connection is quite simple. If a product has a DV port, you can transfer data by connecting to the DV port using the correct cable.
- !!! Please be careful since there are two types of DV ports, (4pin, 6pin). This camcorder has a 4pin terminal.
- ⌘ With a digital connection, video and audio signals are transmitted in digital format, allowing high quality images to be transferred.

Connecting to a PC

- ⌘ If you want to transmit data to a PC, you must install a IEEE 1394 add-on card onto the PC. (not supplied)
- ⌘ The frame rate recorded for video capturing is dependent on the capacity of the PC.

Notes

- When you transmit data from the camcorder to another DV device, some functions may not work. In this occurs, please reconnect the DV cable or turn the power OFF and ON again.
- VP-D340i/D380i can receive digital data from another DV device.
- You can record a picture transferred over a DV connection on VP-D340i/D380i.

IEEE 1394 Data Transfer

● System requirements

- CPU : faster Intel® Pentium III™ 450Mhz compatible.
- Operating system : Windows® 98SE, ME, XP, Mac OS
- Main memory : more than 64 MB RAM
- IEEE1394 add-on card or built in IEEE1394 card

Recording with a DV connection cable (VP-D340i/D380i only)

1. Set the power switch to VCR mode.
2. Connect the DV cable (not supplied) from the DV IN/OUT port of the camcorder to the DV IN/OUT port of the other DV device.
 - Make sure that DV IN appears on the screen.
3. Press the START/STOP button to begin REC PAUSE mode.
 - PAUSE is displayed on the OSD.
4. Start playback on the other DV device while you monitor the picture.
5. Press the START/STOP button to start recording.
 - If you want to pause recording momentarily, press the START/STOP button again.
6. To stop recording, press the ■ (STOP) button.

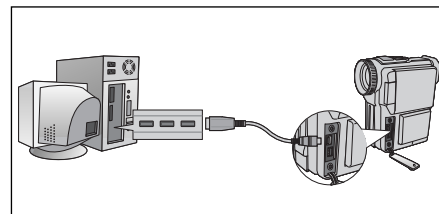

Note

- When using this camcorder as a recorder, the pictures that appear on a monitor may seem uneven, however recorded pictures will not be affected.

USB interface

● Transferring a Digital Image through a USB Connection

- ⌘ You can easily transfer a still image from a camera, tape, memory to a PC without additional add-on cards via a USB connection.
- ⌘ You can transfer an image to a PC via a USB connection.
- ⌘ If you transfer data to a PC, you need to install the software (Driver, Editing software) supplied with the camcorder.

System Requirements

- CPU : Intel® Pentium II™ 400MHz processor compatible or better
- Operating system : Windows® 98/98SE/ME/2000/XP
- RAM : 64 MB or more
- CD-ROM: 4x CD-ROM drive
- VIDEO : 65,000-colour or better video display card
- Available USB port
- Hard Disc : 4GB (8GB recommended)

Notes

- Intel® Pentium II™ is a trademark of the Intel Corporation.
- Windows® is a registered trademark of the Microsoft® Corporation.
- All other brands and names are property of their respective owners.

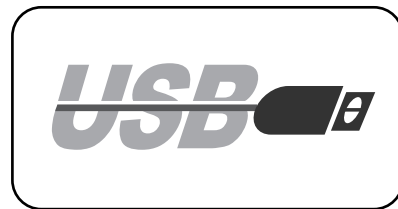

USB interface

Installing DVC Media Program (VP-D340/D340i only)

- ⚠ Do not connect the camcorder to PC before installing the program.
- ⚠ If another camera or scanner is connected, please disconnect it in advance.
- ⚠ This explanation is based on Windows® 98SE OS.

How to install the program

1. The install program automatically operate when the CD is inserted into CD-ROM.



Note

If the install program does not operate, please double click Install.exe in CD-ROM Drive.

2. Click  to install the program.
3. Follow the instruction to install.

USB interface

4. The below window displays the folder to install the program.

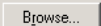
- Basically the program is installed in the following folder.
C:\Programfiles\Samsung\DVC Media 2.0
- Click  to change the folder.

5. Connect the camcorder to PC.

6. PC finds a new hardware and install a driver automatically.

7. If the driver is installed, the install is completed.

8. Execute DVC Media 2.0 player on the Windows wall paper.

Note

- DVC Media 2.0 User's Manual is included on the accompanying CD in Adobe's Portable Document Format (PDF). The user's manual can be viewed using Acrobat Reader software, which is also included on the CD. (The Acrobat Reader is a freeware product of Adobe Systems, Inc.)

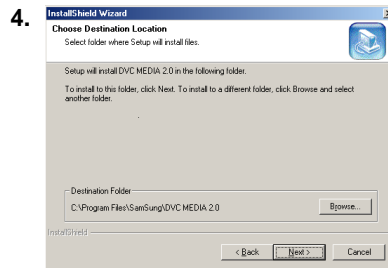

USB interface

Installing DVC Media 4.0 Program (VP-D380/D380i only)

- ⚡ Do not connect the camcorder to PC before installing the program.
- ⚡ If another camera or scanner is connected, please disconnect it in advance.
- ⚡ This explanation is based on Windows® 98SE OS.

Program installation

1. Insert the software CD into CD-ROM drive.
 - Installation selection screen appears in the monitor.
2. If the installation selection screen does not appear after inserting a CD, click “Run” on the Windows “Start” menu and execute SETUP.EXE file to begin installation.
 - When CD-ROM drive is set to “D:” drive: type “D:\setup.exe” and press Enter.
3. Click a button to install the selected software.
 - DVC Driver
 - USB Software
 - Editing Software

Install the DVC Driver

4. When you see the Start window, click “DVC Driver” to continue installation.



USB interface

Install the USB Software (DVC media 4.0™)

4. Repeat steps 1~3.
5. When you see the Start window, click “DVC media 4.0™” to continue installation.
6. Select a language and click “OK”.
7. When the dialogue box appears, click the “NEXT” button.
8. Choose the Destination Folder:
 - To install to default folder, click “NEXT”
 - To install to different folder, click “ Browse” and select another folder.
9. Click the “NEXT” button.
10. Files are copied to selected folder.
11. When the dialogue box appears, click Finish.

Note

- DVC Media 4.0 User's Manual is included on the accompanying CD in Adobe's Portable Document Format (PDF).
The user's manual can be viewed using Acrobat Reader software, which is also included on the CD. (The Acrobat Reader is a freeware product of Adobe Systems, Inc.)

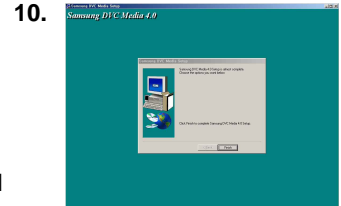
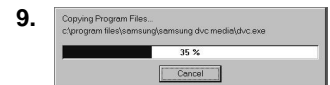
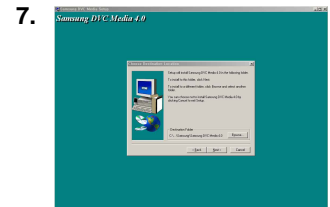
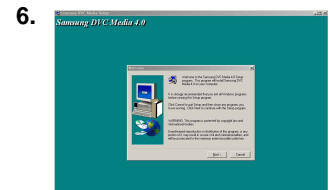

USB interface

Connecting to a PC

1. Connect a USB cable to the USB port on the PC.
2. Connect the other end of the USB cable into the proper terminal on the camcorder. (USB jack)
3. Connect the audio cable to the Line input jack of the PC.
If the PC has no Line input jack, connect the audio cable to the MIC input jack.
In this case, however, a noise may be produced depending on the PC.

Notes

- If you disconnect the USB cable from the PC or the camcorder while transferring, the data transmission will stop and the data may be damaged.
- If you connect the USB cable to a PC via a USB HUB or simultaneously connect the USB cable along with other USB devices, the camcorder may not work properly.
 - If this occurs, remove all USB devices from the PC and reconnect the camcorder.

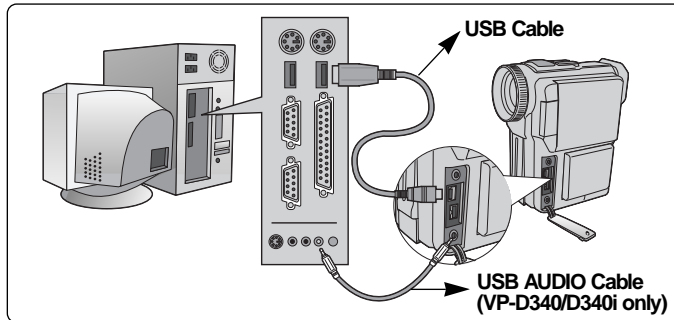

Digital Still Camera mode (VP-D380/D380i only)

Memory Stick

- ⌘ The Memory Stick stores and manages still images recorded by the camera.

Memory Stick Functions

- ⌘ Recording still images
- ⌘ Viewing still images 3 ways
 - Single
 - Slide show
 - Multi screen
- ⌘ Protecting images against accidental erasure
- ⌘ Deleting images recorded on a Memory Stick
- ⌘ Print marking still images
- ⌘ Formatting a Memory Stick

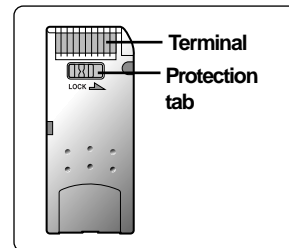

Notes

- You can use most of the camera's functions when recording to the Memory Stick.
- "▶▶▶" appears on the screen while recording to the Memory Stick.
- While recording or loading an image, do not eject or insert the Memory Stick.
 - Inserting or ejecting a Memory Stick while recording or loading an image can cause data damage.
- If you want to save all images on the Memory Stick, set the write-protect tab on the Memory Stick to LOCK.



- "Memory Stick" and  are trademarks of Sony Corporation.
- All other product names mentioned herein may be the trademarks or registered trademarks of their respective companies. Furthermore, "™" and "®" are not mentioned in each instance in this manual.

Digital Still Camera mode (VP-D380/D380i only)

Inserting and removing the Memory Stick

● Inserting Memory Stick



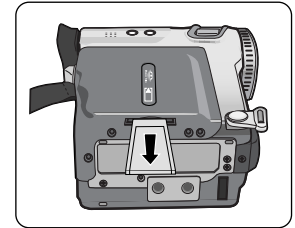
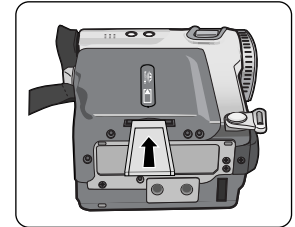

1. Turn the Power switch to OFF.
2. Insert the Memory Stick into the Memory Stick slot located on the camcorder, in the direction of the arrow.

● Removing the Memory Stick

1. Turn the Power switch to OFF.
 2. Remove the Memory Stick by pushing the card in and letting it spring out.
- ⚠ Do not attempt to pull the Memory Stick out without first pushing it in.



Notes

- If you turn the power switch to M.PLAY, the last recorded image appears.
 - If there are no recorded images on the Memory Stick, NO STORED IMAGE! and  will display on the screen.
- Do not turn the power off while recording, loading, erasing or formatting.
- Please turn the power off before you insert or remove the Memory Stick. You could lose data on the Memory Stick.
- Do not allow metal substances to come in contact with the terminals of the Memory Stick.
- Do not bend, drop or apply strong shock to Memory Stick.
- After pulling the card out from the camcorder, please keep the Memory Stick in a soft case to prevent static shock.
- The stored contents may be changed or lost as a result of misuse, static electricity, electric noise or repair. Save important images separately.
- Samsung is not responsible for data loss due to misuse.
- If the USB cable is connected to the camcorder, the  (DELETE),  (S.SHOW),  (FWD),  (REV) buttons are not available in M.PLAY mode.

Digital Still Camera mode (VP-D380/D380i only)

Structure of folders and files on the Memory Stick

- ⌘ The still images that you recorded are saved in JPEG file format on the Memory Stick.
- ⌘ Each file has a file number and all files are assigned to a folder.
 - A file number from DCAM0001 to DCAM9999 is sequentially assigned to each recorded image.
 - Each folder is numbered from 100SSDVC to 999SSDVC and recorded on the Memory Stick.

Image Format

- ⌘ Images are compressed in JPEG (Joint Photographic Experts Group) format.
- ⌘ The number of pixels are 640 × 480 (VGA) in each mode.

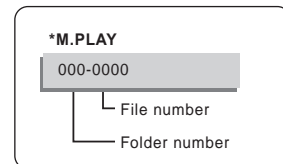
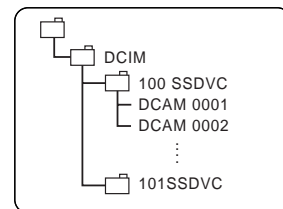

Digital Still Camera mode (VP-D380/D380i only)

Selecting the image quality

⚙ You can select the quality of a still image to be recorded.

Select the image quality

1. Set the power switch on the M.REC or VCR mode.
2. Press the MENU button.
 - The menu list will appear.
3. Turn the MENU DIAL to highlight MEMORY.
4. Push the MENU DIAL to enter the sub-menu.
5. Turn the MENU DIAL to highlight QUALITY in the submenu.
6. Push the MENU DIAL.
7. Using the MENU DIAL, select the image quality.
 - Push the MENU DIAL to confirm the image quality.
 - If you exit the sub-menu without pushing the MENU DIAL, the quality mode is not changed.
8. To exit, press the MENU button.

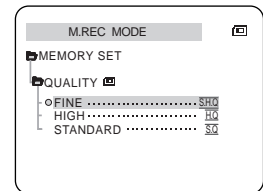
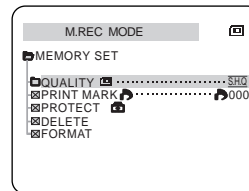
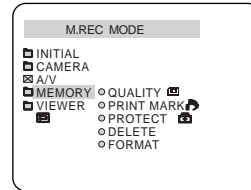

● Number of images on the Memory Stick.

QUALITY	8MB	16MB
FINE	Approx.60	Approx.120
HIGH	Approx.120	Approx.240
STANDARD	Approx.240	Approx.480

- The actual number that you can record varies depending on the image size.

Digital Still Camera mode (VP-D380/D380i only)

Recording Still images to a Memory Stick in M.REC Mode.

- ⌘ You cannot record moving pictures onto a Memory Stick.
- ⌘ Audio cannot be recorded onto the Memory Stick.

Recording images to a Memory Stick.

1. Set the power switch to M.REC.
2. Press the PHOTO button lightly (about halfway down) and hold it.
 - If you do not wish to record, release the pressure from the button.
3. Press the PHOTO button fully down.
 - The still image is recorded to the Memory Stick.
 - While the camcorder is recording the still image, “▶▶▶” appear on the screen.

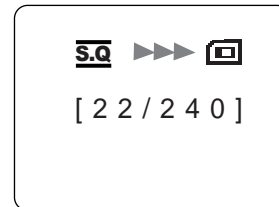
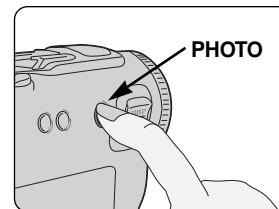
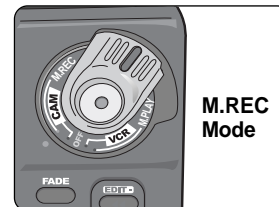

Digital Still Camera mode (VP-D380/D380i only)

Recording an image from a cassette as a still image.

- ⌘ You can record still image from a cassette onto a Memory Stick.
- ⌘ If you want to recorded multiple still images from a cassette to a Memory Stick, use the COPY function.

1. Set the power switch to VCR mode.
2. Play back the cassette.
3. Press the PHOTO button lightly (about halfway down), when the image you want to record appears.
 - The tape is set to play back pause (STILL) mode.
 - If you want to change the captured image without recording, release the PHOTO button, select the image again.
4. Press the PHOTO button fully down.
 - The still image is recorded to the Memory Stick.
 - While the camcorder is recording the still image, “▶▶▶” appears on the screen.

Digital Still Camera mode (VP-D380/D380i only)

Viewing Still images

- ⌘ You can playback and view still images recorded on the Memory Stick.
- ⌘ There are 3 ways to view recorded images.
 - Single : To view an image frame by frame.
 - Slide show : To view all images automatically and in consecutive order.
 - Multi screen: To view 6 images at once.

To view a Single image

1. Set the power switch to M.PLAY mode.
 - The last recorded image appears.
 - If there are no recorded images on the Memory Stick, NO STORED IMAGE! and  will display on the screen.
2. Using the **▶▶** (FWD) and **◀◀** (REV) buttons, search for the desired still image.
 - To view the next image : press the **▶▶** (FWD) button.
 - To view the previous image : press the **◀◀** (REV) button.
 - Pressing **▶▶** (FWD) when you are on the last image will take you to the first image and pressing **◀◀** (REV) when you are on the first image will take you to the last image.
 - Keep pressing **▶▶** (FWD) or **◀◀** (REV) to search for an image quickly.



To view a slide show

1. Set the power switch to M.PLAY mode.
 - The last recorded image appears
2. Press the **▶||** (S.SHOW) button.
 - All images will be played back consecutively for 3~4 seconds each.
3. To stop the slide show, press the **▶||** (S.SHOW) button again.

ENGLISH

Digital Still Camera mode (VP-D380/D380i only)

To view the Multi Screen

1. Set the power switch to M.PLAY.
 - The last recorded image appears.
2. Press the PHOTO button to view 6 images on a single screen.
 - A selection mark (▶) appears under the image.
 - Turn the MENU DIAL downwards to go the previous image and upwards to go to the next image.
 - Jump to the next/previous multi screen with the ▶▶ (FWD) or ◀◀ (REV) buttons.
3. Press the PHOTO button.
 - The image you have marked fills the whole display.

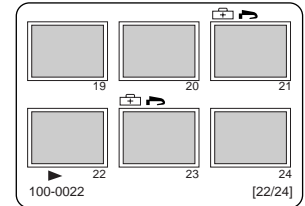

Note

- You can delete the selection marked image by pressing ■ (DELETE) on the function buttons.

Digital Still Camera mode (VP-D380/D380i only)

Copying still images from a cassette to Memory Stick

⌘ You can copy still images with PHOTO function on a cassette onto a Memory Stick.

1. Set the power switch to the VCR mode.
2. Press the MENU button.
3. Turn the MENU DIAL to highlight A/V and push the MENU DIAL.
 - The submenu will appear.
4. Turn the MENU DIAL to highlight PHOTO COPY and push the MENU DIAL.
 - All still images that recorded on a cassette will be copied to a Memory Stick.
5. The camcorder automatically performs the photo search to find still images and copying starts.
6. Press ■ (STOP) button to stop copying.
 - Copying stops when the cassette is finished or Memory Stick is full.

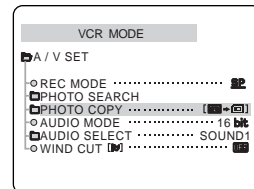
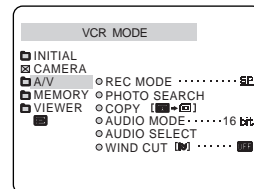

Digital Still Camera mode (VP-D380/D380i only)**Marking images for printing**

- ⚙ This camcorder supports the DPOF (Digital Print Order Format) print format.
- ⚙ You can automatically print images recorded on a Memory Stick with a printer supporting DPOF.
- ⚙ There are 2 ways to make a PRINT MARK.
 - THIS FILE : You can set a print mark on the photo image displayed on the LCD.
 - ALL FILES : To print 1 copy each of all of the stored images.

1. Set the power switch to M.PLAY mode
 - The last recorded image appears.
2. Using the **▶▶** (FWD) and **◀◀** (REV) buttons, search for the still image that you want to mark.
3. Press the MENU button.
4. Turn the MENU DIAL to highlight MEMORY and push the MENU DIAL.
 - The MEMORY SET submenu will appear.
5. Turn the MENU DIAL to highlight PRINT MARK, push the MENU DIAL.
6. Use the MENU DIAL to select either THIS FILE or ALL FILES and push the MENU DIAL.
7. Use the MENU DIAL to select the quantity and push the MENU DIAL.

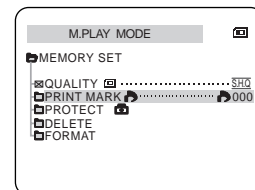
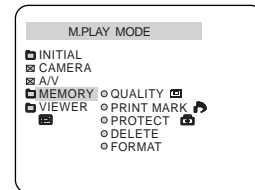
**Notes**

- When you setup the PRINT MARK option to ALL FILES, up to 999 images from the current file are printed.
- The ALL FILES option may require extended operation time depending on the number of stored images.

Digital Still Camera mode (VP-D380/D380i only)

Protection from accidental erasure

- ⌘ You can protect important images from accidental erasure.
 - If you execute FORMAT, all images including protected images will be erased.
- 1. Set the power switch to M.PLAY mode.
 - The last recorded image appears.
 - If there are no recorded images on the Memory Stick, NO STORED IMAGE! and  will display on the screen.
- 2. Using the ►► (FWD) and ◀◀ (REV) buttons, search for the still image that you want to protect.
- 3. Press the MENU button.
- 4. Turn the MENU DIAL to highlight MEMORY and push the MENU DIAL.
 - The MEMORY SET submenu will appear.
- 5. Turn the MENU DIAL to highlight PROTECT and push the MENU DIAL.
- 6. Press the MENU DIAL to alternate between THIS FILE ON/OFF.
 - THIS FILE : protects the currently selected file from erasure.
- 7. Using the ►► (FWD) and ◀◀ (REV) buttons, search for other still images that you wish to protect.
 - Deactivate the image protection for the image by following step 6.
- 8. To exit the menu, press the MENU button.

Digital Still Camera mode (VP-D380/D380i only)

Deleting Still images

- ⌘ You can erase the still images recorded on the Memory Stick.
 - ⌘ If you want to delete protected images, you must first deactivate the image protection.
 - ⌘ An image which has been deleted cannot be recovered.
1. Set the power switch to M.PLAY mode
 2. Using the ►► (FWD) and ◀◀ (REV) buttons, search for the still image that you want to delete.
 3. Press the MENU button.
 4. Turn the MENU DIAL to highlight MEMORY and push the MENU DIAL.
 - The MEMORY SET submenu will appear.
 5. Turn the MENU DIAL to highlight DELETE and push the MENU DIAL.
 - Using the MENU DIAL, select either THIS FILE or ALL FILES and push the MENU DIAL.
 - THIS FILE : deletes only the file currently selected.
 - ALL FILES : deletes all files stored in the Memory Stick.
 6. Turn the Menu Dial down to select Execute, and up to select Cancel.
 - EXECUTE : deletes the selected image(s).
 - CANCEL : does not delete the selected image(s) and returns to the previous menu.

Notes

- If you try to delete a protected image, "Protect!" appears on the screen.
- You can delete the current displayed image (when still images are on) by pressing ■ (DELETE) on the function buttons. You will see you "DELETE REALLY?". Press again to delete the current image.

Digital Still Camera mode (VP-D380/D380i only)

Formatting the Memory Stick

- ⌘ You can use the MEMORY FORMAT functions to completely delete all images and options on the Memory Stick, including protected images.
- ⌘ The format function restores the Memory Stick to its initial state.
- ⌘ The Memory Stick supplied with this camcorder has been formatted already.

Attention

- ⌘ If you execute the MEMORY FORMAT function, all images will be erased completely and erased images cannot be recovered.
1. Set the power switch to M.PLAY mode.
 2. Press the MENU button.
 3. Turn the MENU DIAL to highlight MEMORY and push the MENU DIAL.
 - The sub menu will appear.
 4. Select FORMAT from the list and push the MENU DIAL.
 5. "ALL FILES ARE DELETED! FORMAT REALLY?" appears on the screen.
 6. Using the MENU DIAL, select the item.
 - NO : To return to previous menu
 - YES : To start formatting.
 7. Push the MENU DIAL.
 8. To exit the menu, press the MENU button.

Note

- "Memory Stick" formatted on the PC with the USB adaptor (not supplied) do not have a guaranteed compatibility with this camcorder.
If you want to format the Memory Stick on the PC, use the "Memory Stick formatter" supplied with the software CD.

Maintenance

Cleaning and Maintaining the Camcorder

Cleaning the VIEWFINDER

1. Pull the VIEWFINDER out.
2. As shown in the illustration, press the fix button located on the left side of the camcorder section adjacent to the VIEWFINDER and pull the VIEWFINDER out.
3. Clean the VIEWFINDER lens and the lens on the camcorder with a soft cotton swab.
4. Once the cleaning is completed, place the VIEWFINDER back on to the camcorder.

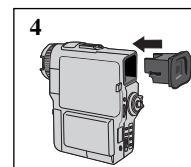
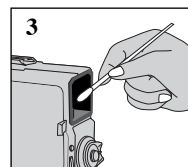
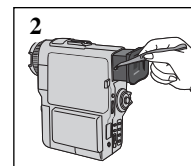
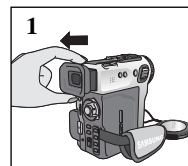

Cleaning the Video Heads

To ensure normal recording and clear pictures, clean the video heads when the playback pictures display square block-shaped noise or distortion or if only a blue screen appears during playback, as the video heads may be dirty.

1. Set the power switch to VCR mode.
2. Insert the cleaning tape.
3. Press the ►|| (PLAY/STILL) button.
4. Press the ■ (STOP) button after 10 seconds.

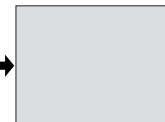
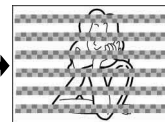

Notes

- Check the quality of the picture using a videocassette.
If the picture quality has not improved, repeat the operation.
If the problem continues, contact your local authorized service centre.
- Clean the video heads with a dry type cassette cleaner.

Maintenance

Using Your Camcorder Abroad

- ⌘ Each country or region has its own electric and colour systems.
- ⌘ Before using your camcorder abroad, check the following items.

Power sources

- You can use your camcorder in any country or area with the supplied AC Power Adapter within 100V to 240V, 50/60 Hz.
- Use a commercially available AC plug Adapter, if necessary, depending on the design of the local wall outlet.

Colour system

- You can view your recording in the viewfinder.
However, to view it on a television or copy it to a videocassette recorder, the television or VCR must be PAL-compatible and have the appropriate audio/video jacks.
Otherwise, you may need to use a transcoder.

● PAL-compatible Countries/Regions

Australia, Austria, Belgium, Bulgaria, China, CIS, Czech Republic, Denmark, Egypt, Finland, France, Germany, Greece, Great Britain, Holland, Hong Kong, Hungary, India, Iran, Iraq, Kuwait, Libya, Malaysia, Mauritius, Norway, Romania, Saudi Arabia, Singapore, Slovak Republic, Spain, Sweden, Switzerland, Syria, Thailand, Tunisia, etc.

● NTSC-compatible Countries/Regions

Bahamas, Canada, Central America, Japan, Mexico, Philippines, Korea, Taiwan, United States of America, etc.

Note



- You can make recordings with your camcorder and view pictures on the LCD from anywhere in the world.

Troubleshooting

Troubleshooting

- ⌘ Before contacting a Samsung authorized service centre, perform the following simple checks. They may save you the time and expense of an unnecessary call.

Self Diagnosis Display

Display	Blinking	Informs that...	Action
	slow	the battery pack is almost discharged.	Change to a charged one.
TAPE END!	slow	When the remaining time on the tape is about 2 minutes.	Prepare a new one.
TAPE END!	no	the tape reached its end.	Change to a new one.
TAPE!	slow	there is no tape in camcorder.	Insert a tape.
PROTECTION!	slow	the tape is record protected.	If you want to record, release the protection.
▲ ...D L C R	slow	the camcorder has some mechanical fault.	1. Eject the tape. 2. Set to OFF. 3. Detach the battery. 4. Reattach the battery. * If unresolved contact your local service representative.
	slow	moisture condensation has formed in the camcorder.	see below.

Moisture Condensation

- ⌘ If the camcorder is brought directly from a cold place to a warm place, moisture may condense inside the camcorder, on the surface of the tape, or on the lens. In this condition, the tape may stick to the head drum and be damaged or the unit may not operate correctly.
To prevent possible damage under these circumstances, the camcorder is fitted with a moisture sensor.
- ⌘ If there is moisture inside the camcorder,  (DEW) is displayed. If this happens, none of the functions except cassette ejection will work.
Open the cassette compartment and remove the battery pack.
Leave the camcorder for at least two hours in a dry warm room.

Troubleshooting

Self Diagnosis Display in M.REC/M.PLAY mode (VP-D380/D380i only)

Display	Blinking	Informs that...	Action
MEMORY STICK!	slow	There no Memory Stick in the camcorder.	Insert a Memory Stick.
MEMORY FULL!	slow	There is not enough memory to record.	Change to a new Memory Stick or erase recorded image.
NO STORED IMAGE!	slow	There are no images recorded on the Memory Stick.	Record new images.
WRITE PROTECT!	slow	The Memory Stick is record protected.	Release the write-protect tab on the Memory Stick.
PROTECT!	slow	When you try to delete to protected image.	Cancel the protect of image.
READ ERROR!	slow	The camera can not playback.	Format a Memory Stick or insert Memory Stick recorded on this camcorder.
WRITE ERROR!	slow	The camera can not record.	Format a Memory Stick or change to a new Memory Stick.
NOT FORMAT!	slow	The Memory Stick needs to format.	Format a Memory Stick.
NOW DELETE...	slow	When progressing FILE DELETE.	Wait until the end of deleting.
NOW FORMAT...	slow	When progressing MEMORY FORMAT.	Wait until the end of formatting.
NOW COPY...	slow	When progressing FILE COPY.	Wait until the end of copying.

Troubleshooting

⚡ If these instructions do not solve your problem, contact your nearest Samsung authorized service centre.

Symptom	Explanation/Solution
You cannot switch the camcorder on	Check the battery pack or the AC Power Adapter.
START/STOP button does not operate while recording	Check the POWER switch is set to CAM. You have reached the end of the cassette. Check the record protection tab on the cassette.
The camcorder goes off automatically.	You have left the camcorder set to STBY for more than 5 minutes without using it. The battery pack is fully exhausted.
The battery pack is quickly exhausted.	The atmospheric temperature is too low. The battery pack has not been charged fully. The battery pack is completely dead, and cannot be recharged. Use another battery pack.
When you see a blue screen during playback	The video heads may be dirty. Clean the head with a cleaning tape.
A vertical stripe appears on the screen when recording a dark background.	The contrast between the subject and the background is too great for the camcorder to operate normally. Make the background bright to reduce the contrast or use the BLC function while you are recording brighter.
The image in the viewfinder is blurred.	The Viewfinder lens has not been adjusted. Adjust the viewfinder control lever until the indicators displayed on the viewfinder come into sharp focus.
Auto focus does not work.	Check the M.FOCUS menu. Auto focus does not work in the Manual Focus mode.
Play, FF or REW button does not work.	Check the POWER switch. Set the power switch to VCR. You have reached the beginning or end of the cassette.
When you see a broken block image during the EDIT SEARCH.	This is normal operation and is not a failure or defect.

Specifications

Model name: VP-D340/D340i/D380/D380i

System	
Video signal	PAL, CCIR standards
Video recording system	2 rotary heads, Helical scanning system
Audio recording system	Rotary heads, PCM system
Usable cassette	Digital video tape (6.35mm width): Mini DV cassette
Tape speed	SP: approx. 18.83mm/s LP: approx. 12.57mm/s
Tape recording time	SP: 60 minutes (when using DVM 60), LP: 90 minutes (when using DVM 60)
FF/REW time	Approx. 150 sec. (using DVM60 tape)
Image device	CCD (Charge Coupled Device)
Lens	F1.8 12x(Optical), 480x(Digital) Electronic zoom lens
Filter diameter	Ø37
LCD monitor/Viewfinder	
Size/dot number	2.5inch/200,000
LCD monitor Method	TFT LCD
Viewfinder	VP-D380/D380i : 0.44" colour LCD, VP-D340/D340i : 0.24" B/W LCD
Connectors	
Video output	1Vp-p (75Ω terminated)
S-video output	Y: 1Vp-p, 75Ω, C: 0.286Vp-p, 75Ω
Audio output	-7.5dBs (600Ω terminated)
DV input/output	VP-D340i/D380i : 4pin special in/out connector, VP-D340/D380 : out only
USB output	Mini-B type connector
External mic	Ø3.5 stereo

General	
Power source	DC 8.4V, Lithium Ion Battery Pack 7.4V
Power source type	Lithium Ion Battery Pack, Power supply (100V~240V) 50/60Hz
Power consumption (Recording)	4.9W(LCD), 3.6W(CVF)
Operating temperature	0°~40°C (32°F~104°F)
Storage temperature	-20°C ~ 60°C (-4°F ~ 140°F)
External dimension	Length 104mm, Height 114mm, Width 53.5mm
Weight	VP-D340/D340i : 470g, VP-D380/D380i : 480g (Except for Lithium Ion Battery Pack and tape)
Built-in MIC	Omni-directional stereo condenser microphone
Remote control	Indoors: greater than 15m (straight line), Outdoors: greater than 5m (straight line)

INDEX

- A -		- L -	
Accessories	12	LCD	28, 29
Audio dubbing	62	- M -	
AUDIO MODE	50	MF/AF	59
- B -		- O -	
Battery Pack	22	OSD	17, 18
BEEP	37	- P -	
BLC	60	PHOTO SEARCH	64
- C -		PROGRAM AE	40
Cassette	25	Protection	89
Cleaning	93	- Q -	
CLOCK SET	35	Quick Menu	54
Connecting	67	- R -	
CUSTOM Mode	58	REC MODE	49
CUSTOM.Q	48	REMOCON	36
- D -		Remote control	16, 19
DATE/TIME	52	- S -	
DC Cable	21	SHUTTER SPEED	56
Deleting	90	Sound	32
DEMONSTRATION	39	Speaker	32
DSE	46	Still images	85, 87
DV	71, 72	- T -	
- E -		TV DISPLAY	53
EASY Mode	57	- U -	
Edit Search	27	USB	73
EIS	45	- V -	
EXPOSURE	56	Viewfinder	28, 30
- F -		- W -	
Fade	61	WHT. BALANCE	42
Formatting	91	WIND CUT	51
Frame advance	69	- Z -	
Function Butts	15	ZERO MEMORY	70
- H -		Zoom	43, 44
Hand Strap	20	- I -	
- I -		IEEE1394	71
Image quality	82	- J -	

Power Sources (United Kingdom Only)

The mains lead on the power adapter is supplied with a moulded plug incorporating a fuse.

The value of the fuse is indicated on the pin face of the plug and, if it requires replacing, a fuse approved to BS1362 of the same rating must be used.

Never use the plug with the fuse cover omitted if the cover is detachable.

If a replacement fuse cover is required, it must be of the same colour as the pin face of the plug.

Replacement covers are available from your dealer.

If the fitted plug is not suitable for the power points in your house or the cable is not long enough to reach a power point, you should obtain a suitable safety approved extension lead or consult your dealer for assistance.

However, if there is no alternative to cutting off the plug, remove the fuse and then safely dispose of the plug.

Do NOT connect the plug to a mains socket as there is a risk of shock hazard from the bared flexible cord.

IMPORTANT

The wires in the mains lead are coloured in accordance with the following code:

BLUE = NEUTRAL

BROWN = LIVE

As these colours may not correspond to the coloured markings identifying the terminals in your plug, proceed as follows:

The wire coloured BLUE must be connected to the terminal marked with the letter N or coloured BLUE or BLACK.

The wire coloured BROWN must be connected to the terminal marked with the letter L or coloured BROWN or RED.

WARNING

Do not connect either wire to the earth terminal marked with the letter E or the earth symbol, \perp , or coloured GREEN or GREEN and YELLOW.

NOTE

This page is applicable to Great Britain only.

ENGLISH

THIS CAMCORDER IS MANUFACTURED BY:

