

Elo Entuitive Touchmonitor User Guide

15" LCD Desktop Touchmonitor with Magnetic Swipe Reader (serial)

1525L Series

entuitive
Touchmonitors

Revision A

P/N 008568

Elo TouchSystems, Inc.

1-800-ELOTOUCH
www.elotouch.com

tyco
Electronics

ēlo
TOUCHSYSTEMS

Copyright © 2002 Elo TouchSystems Inc. All Rights Reserved.

No part of this publication may be reproduced, transmitted, transcribed, stored in a retrieval system, or translated into any language or computer language, in any form or by any means, including, but not limited to, electronic, magnetic, optical, chemical, manual, or otherwise without prior written permission of Elo TouchSystems.

Disclaimer

The information in this document is subject to change without notice. Elo TouchSystems makes no representations or warranties with respect to the contents hereof, and specifically disclaims any implied warranties of merchantability or fitness for a particular purpose. Elo TouchSystems reserves the right to revise this publication and to make changes from time to time in the content hereof without obligation of Elo TouchSystems to notify any person of such revisions or changes.

Trademark Acknowledgments

IntelliTouch, SecureTouch, AccuTouch, Entuitive, and MonitorMouse are trademarks of Elo TouchSystems, Inc.

Other product names mentioned herein may be trademarks or registered trademarks of their respective companies. Elo TouchSystems claims no interest in trademarks other than its own.

Table of Contents

Chapter 1			
Introduction	1		
Precautions	1		
Chapter 2			
Installation and Setup	3		
Unpacking Your Touchmonitor	3		
Product Overview	4		
Main Unit	4		
Rear View	4		
Side View	5		
Base Bottom View	5		
Touch Interface Connection	6		
Serial Connection	6		
STEP 1-Removing the Back Cover	7		
STEP 2-Connecting the Video Cable	8		
STEP 3-Connecting the Serial Touchscreen Cable	9		
STEP 4-Connecting the Speaker Cable	10		
STEP 5-Connecting the Power Cable	11		
STEP 6-Replacing the Back Cover	11		
USB Connection	12		
STEP 1-Removing the Back Cover	13		
STEP 2-Connecting the Video Cable	14		
STEP 3-Connecting the USB Touchscreen Cable	15		
STEP 4-Connecting the Speaker Cable	16		
STEP 5-Connecting the Power Cable	17		
STEP 6-Replacing the Back Cover	17		
Optimizing the LCD Display	18		
VESA Mount on Your Touchmonitor	18		
Accessing the VESA Mounting Interface	19		
Mounting the Base	19		
Installing the Driver Software	20		
Installing the Serial Touch Driver	21		
Installing the Serial Touch Driver for Windows 2000, Me, 95/98 and NT 4.0	21		
Installing the Serial Touch Driver for MS-DOS and Windows 3.1	22		
Installing the USB Touch Driver	23		
Installing the USB Touch Driver for Windows 2000, Me and 98	23		
Chapter 3			
Operation	25		
About Touchmonitor Adjustments	25		
Using the On-Screen Display (OSD) Menus	25		
Side Bezel Buttons	26		
OSD Menu Function	27		
Chapter 4			
Troubleshooting	29		
Solutions to Common Problems	29		
Appendix A			
Native Resolution	31		
Appendix B			
Touchmonitor Safety	33		
Care and Handling of Your Touchmonitor	34		
Appendix C			
Technical Specifications	35		
Compatible Video Modes	35		
Touchmonitor Specifications	36		
15" LCD Touchmonitor (ET15-XXWA-1) Dimensions	40		
Regulatory Information	43		
Warranty	47		
Index	49		
MSR Reference Manual	51		
Programming Reference Manual	69		

INTRODUCTION

Congratulations on your purchase of an Elo TouchSystems Entuitive touchmonitor. Your new touchmonitor combines the reliable performance of Elo's touch technology with the latest advances in LCD display design. This combination of features creates a natural flow of information between a user and your touchmonitor.

Precautions

Follow all warnings, precautions and maintenance as recommended in this user's manual to maximize the life of your unit. See Appendix B for more information on touchmonitor safety.

About the Product

Your LCD Desktop Touchmonitor is a 15.1" XGA TFT color display with the following features:

- Direct analog RGB input
- 15.0" diagonal screen size
- 16.7 million displayable colors
- 1024 x 768 resolution
- XGA/ SVGA/ VGA/ VESA/ Mac compatible
- 30kHz~62 horizontal scan
- 56~75Hz refresh rate

- Auto adjustment capability
- High quality full screen re-scaling
- Multilingual OSD menus in four languages: English, French, German, Spanish, and Japanese
- Serial or USB touch interface (USB requires Windows 98, 2000, Me and XP.)
- Built in speakers
- Patented touch technology of Elo TouchSystems
- VESA DDC 1/2B data communication
- VESA DPMS power saving
- Stand with minimum 45° angle of tilt.
- Cable management device
- VESA flat panel monitor physical mounting interface (75mm)
- OSD and Power button lockouts

For full Product Specifications refer to Appendix C.

INSTALLATION AND SETUP

This chapter discusses how to install your LCD touchmonitor and how to install Elo TouchSystems driver software.

Unpacking Your Touchmonitor

Check that the following 8 items are present and in good condition:

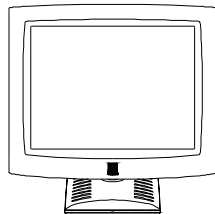

LCD Display

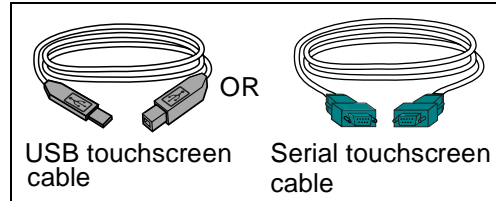

USB touchscreen cable

Serial touchscreen cable

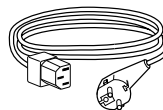

European monitor power cable



Video cable

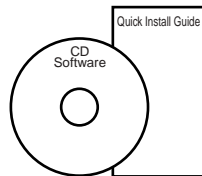

User Guide-on CD,
Quick Install Guide and software CD

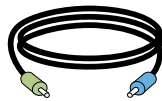

Speaker Cable

Speaker cable

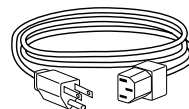

Monitor power cable
(US/Canada)

Product Overview

Main Unit

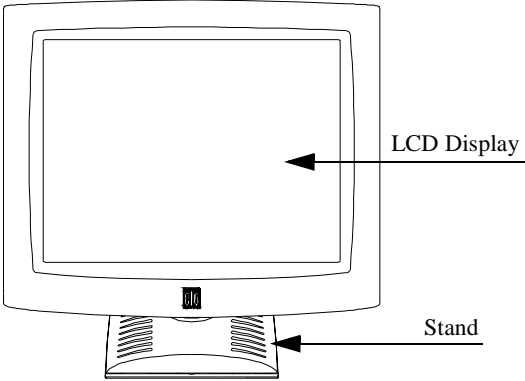

Rear View

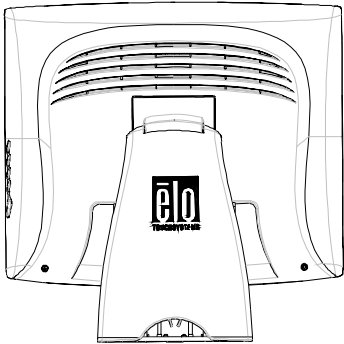

Side View

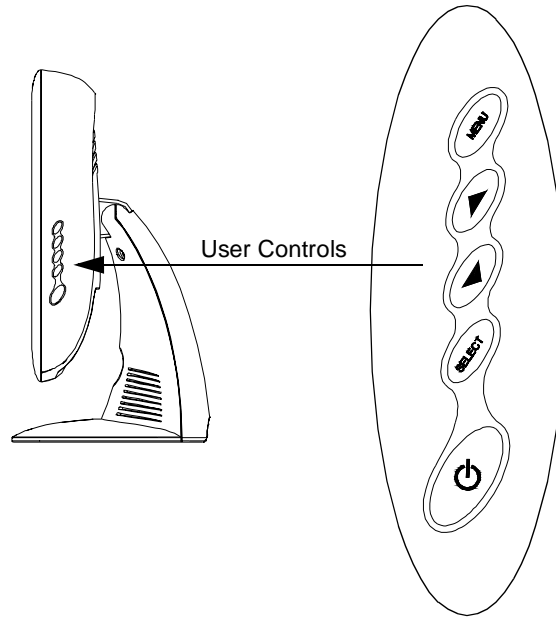

Base Bottom View

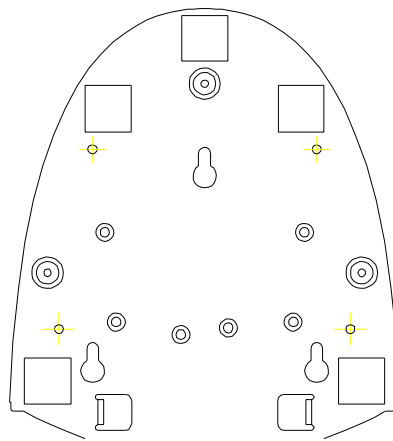

Touch Interface Connection

NOTE: Your interface cables may have been pre-connected to your monitor at the factory.

Your touchmonitor comes with one of the following touchscreen connector cables: **Serial** (RS-232) cable *or* **USB** cable. (For Windows 98, 2000, Me and XP systems only.)

To set up this display, please refer to the following figures and procedures:

Serial Connection

The following illustrations guide you step by step in connecting your touchmonitor using a serial cable connection.

CAUTION



Before connecting the cables to your touchmonitor and PC, be sure that the computer and the touchmonitor are turned off.

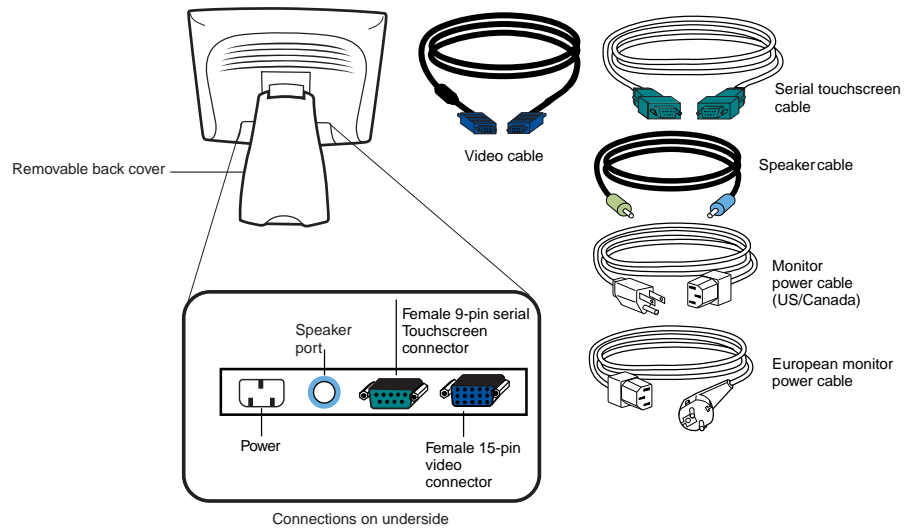

STEP 1-Removing the Back Cover

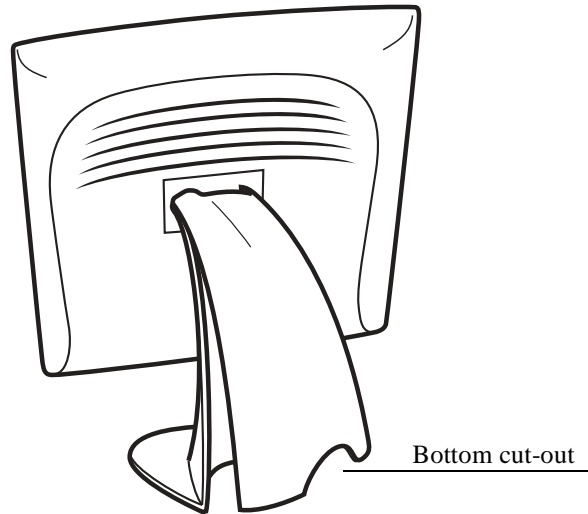

- The cables are routed through the back of the stand.
- To remove the back cover, place one hand at the top of the stand and your other hand on the bottom cut-out.
- Pull forward from the bottom cut-out and twist the cover until it snaps off. The cable ports are located on the underside of your touchmonitor.

STEP 2-Connecting the Video Cable

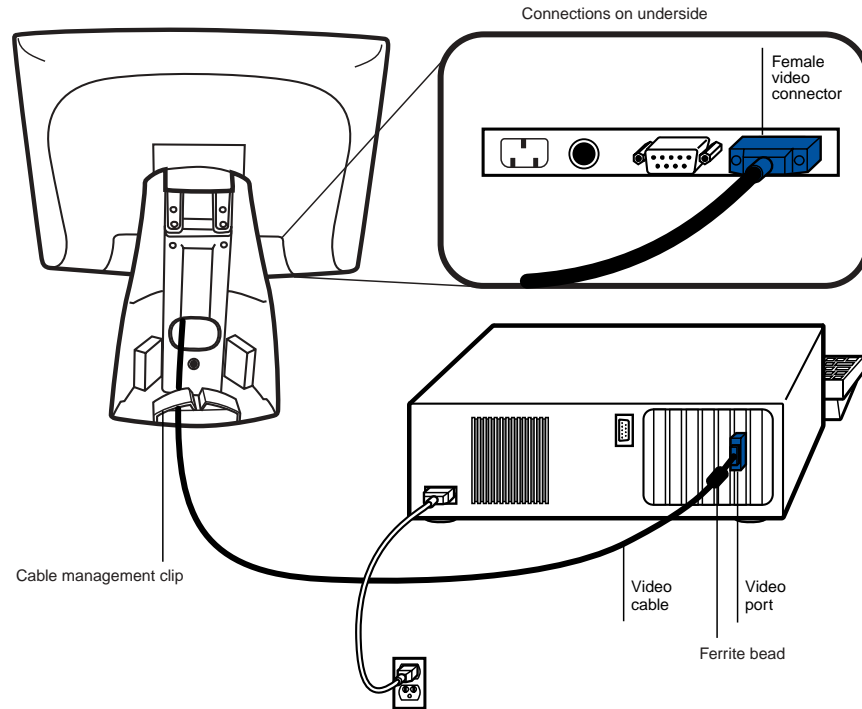

- Tilt the screen up and back to access the connection ports.
- Connect the 15-pin video cable (the ferrite bead end) to the video port on your PC.
- Connect the other end of the video cable to the video connector on your touchmonitor by routing the cable through the hole in the stand.
- Secure the cable to your touchmonitor and PC by turning the screws on the connector clockwise.
- Place the cable in the cable management clip.

STEP 3-Connecting the Serial Touchscreen Cable

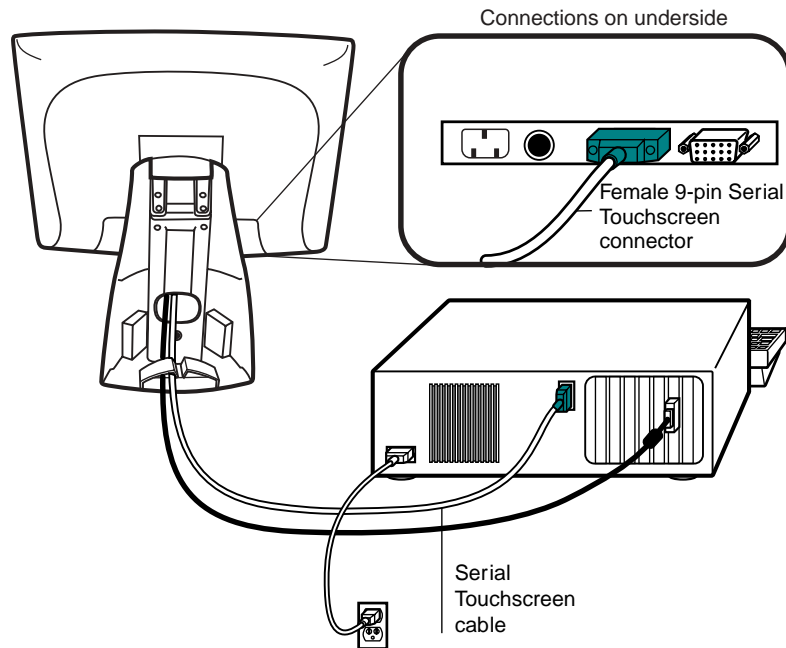

- Connect the female end of the serial (RS-232) cable to the serial port on the back of your PC.
- Connect the male end of the cable to the serial touchscreen connector on your touchmonitor.
- Secure the cable to your touchmonitor and PC by turning the screws on the connector.
- Route the cable through the cable management clip.

STEP 4-Connecting the Speaker Cable

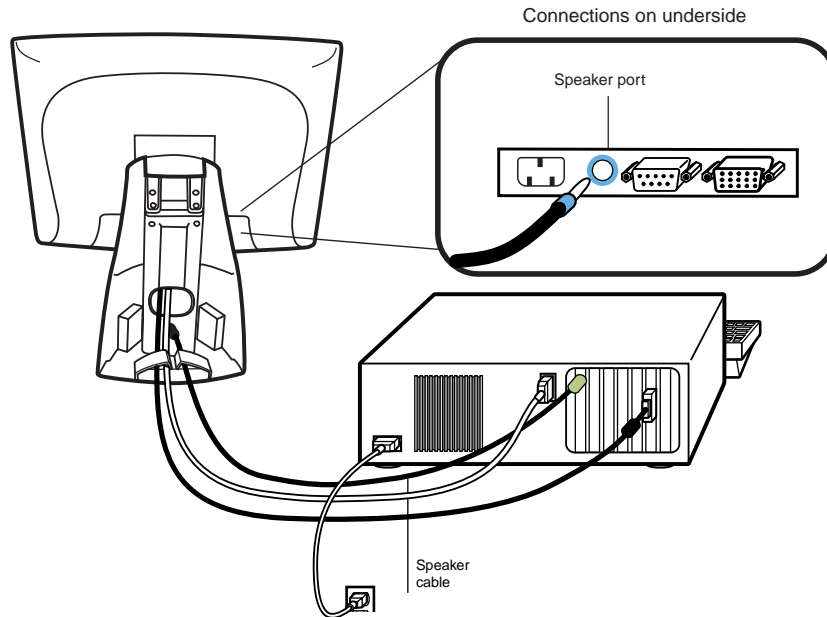

NOTE: If you do not wish to connect the speaker cable, go to step 5.

- To use the built in speakers, you need to connect the speaker cable. Connect the speaker cable to the speaker port inside the back of your touchmonitor.
- Connect the other end of the cable to the speaker connector on your PC.

STEP 5-Connecting the Power Cable

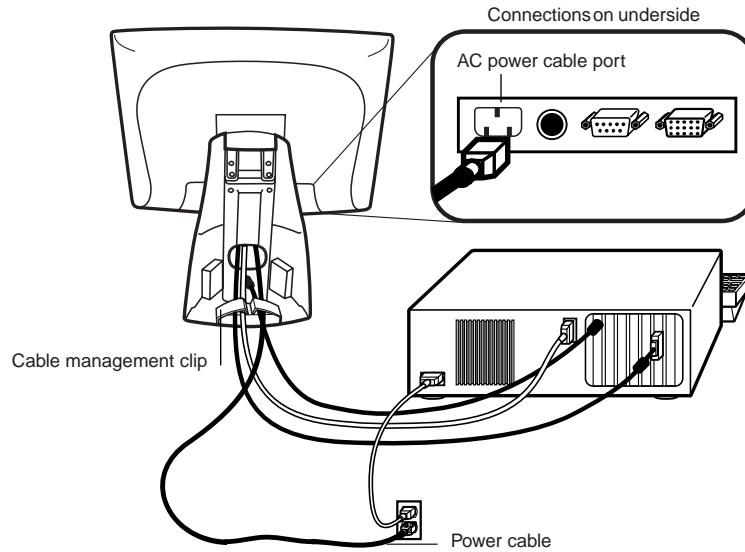

Depending on where you live, you will use either the European or US/Canadian power cable.

- Connect the female end of the power cable to the power port on the touchmonitor.
- Route the cable through the cable management clip.

NOTE: To protect your equipment against risk of damage from electrical surges in the power line, plug the touchmonitor's power cord into a surge protector, and then connect the surge protector to a grounded AC electrical outlet.

STEP 6-Replacing the Back Cover

When all the cables have been connected:

- Replace the back stand cover.
- Power on your PC then your touchmonitor. After a brief pause the picture should appear.

USB Connection

NOTE: A USB connection can only be used if your PC is running Windows 98, 2000, Me or XP.

The following illustrations guide you step by step in connecting your touchmonitor using a USB cable connection.

CAUTION Before connecting the cables to your touchmonitor and PC, be sure that the computer and the touchmonitor are turned off.

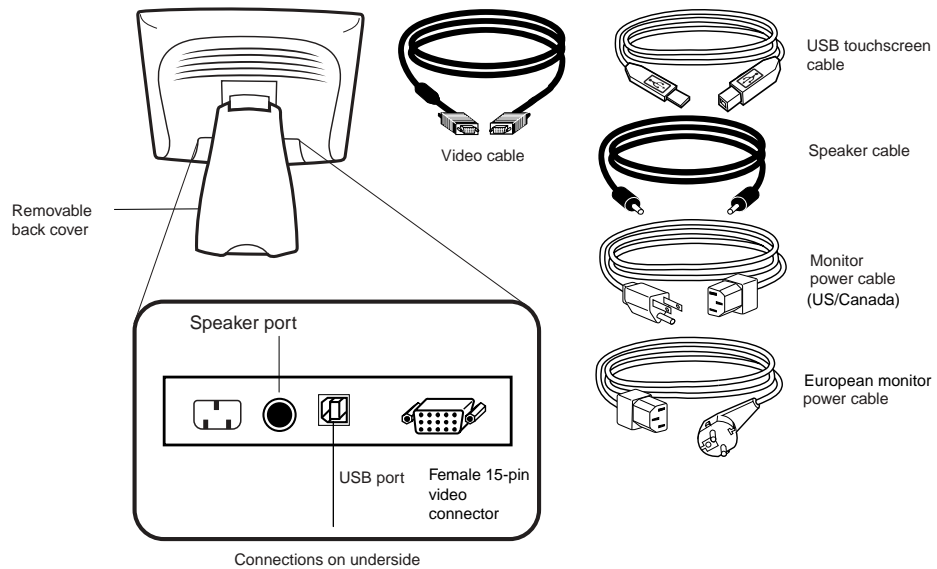

STEP 1-Removing the Back Cover

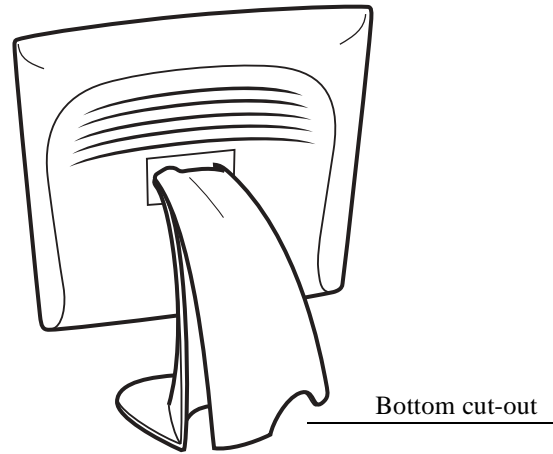

- The cables are routed through the back of the stand.
- To remove the back cover, place one hand at the top of the stand and your other hand on the bottom cut-out.
- Pull forward from the bottom cut-out and twist the cover until it snaps off. The cable ports are located on the underside of your touchmonitor.

STEP 2-Connecting the Video Cable

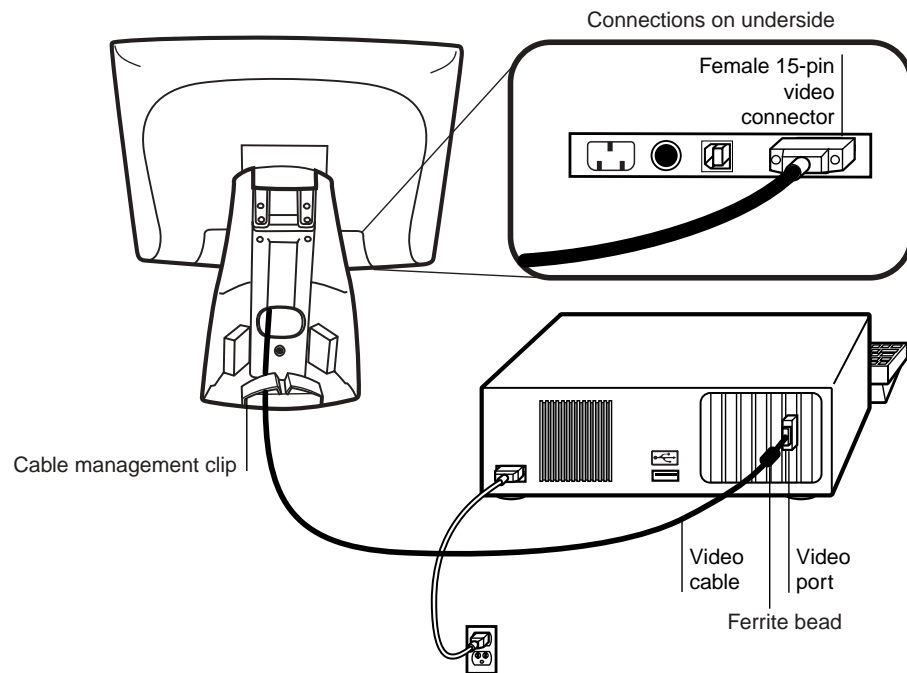

- Tilt the screen up and back to access the connection ports.
- Connect the 15-pin video cable (the ferrite bead end) to the video port on your PC.
- Connect the other end of the video cable to the video connector on your touchmonitor by routing the cable through the hole in the stand.
- Secure the cable to your touchmonitor and PC by turning the screws on the connector clockwise.
- Place the cable in the cable management clip.

STEP 3-Connecting the USB Touchscreen Cable

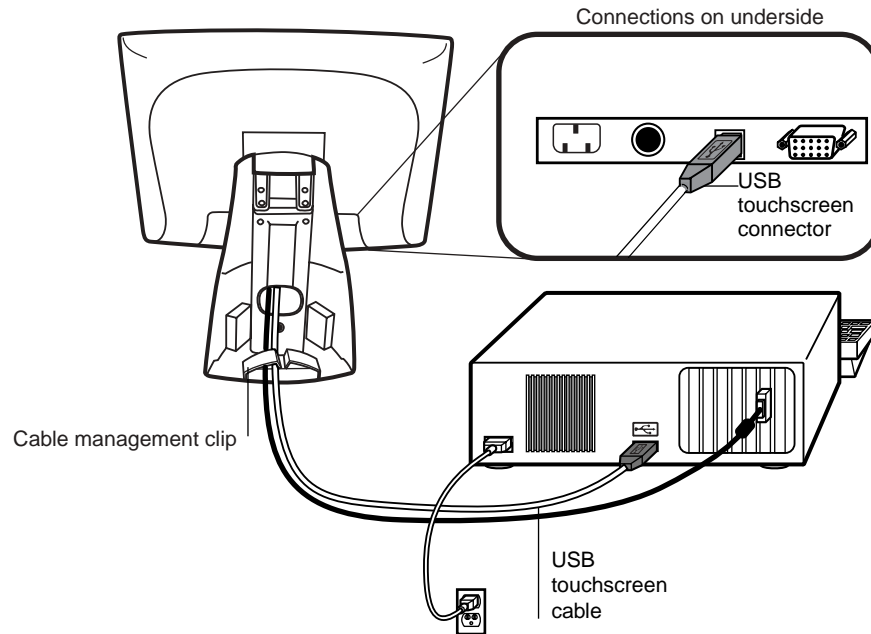

- Connect the USB touchscreen cable to the USB touchscreen connector on the touchmonitor.
- Connect the other end of the USB touchscreen cable to your PC.
- The touchscreen cable connectors should fit snugly into the connectors on your touchmonitor and PC.
- Route the cable through the cable management clip.

STEP 4-Connecting the Speaker Cable

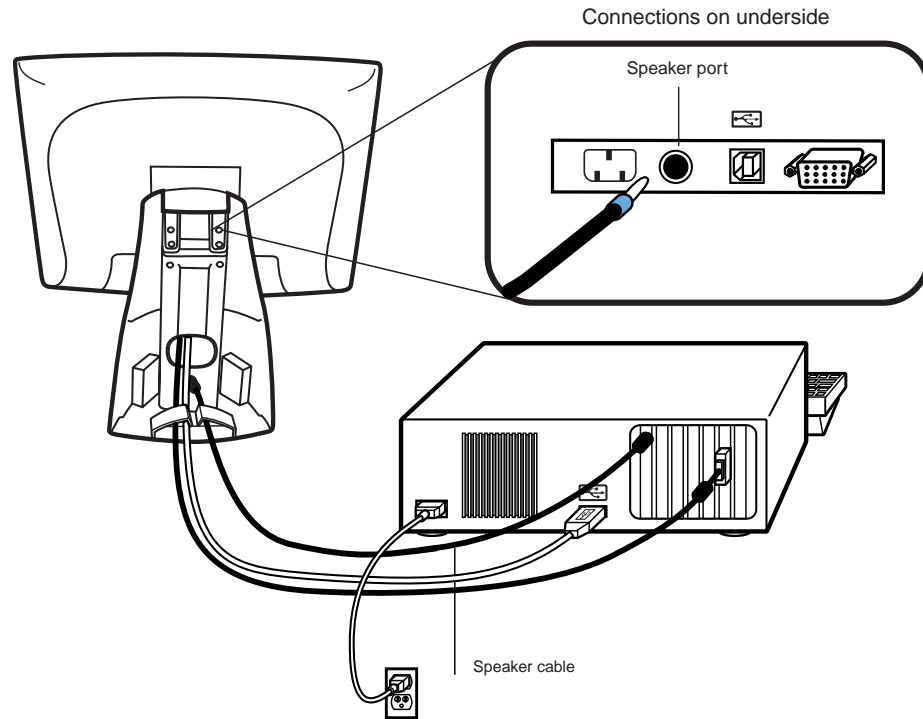

NOTE: If you do not wish to connect the speaker cable, go to step 5.

- To use the built in speakers, you need to connect the speaker cable. Both ends of the speaker cable are identical, so you can connect either end of the speaker cable to the speaker port inside the stand of your touchmonitor.
- Connect the other end of the cable to the speaker connector on your PC.

STEP 5-Connecting the Power Cable

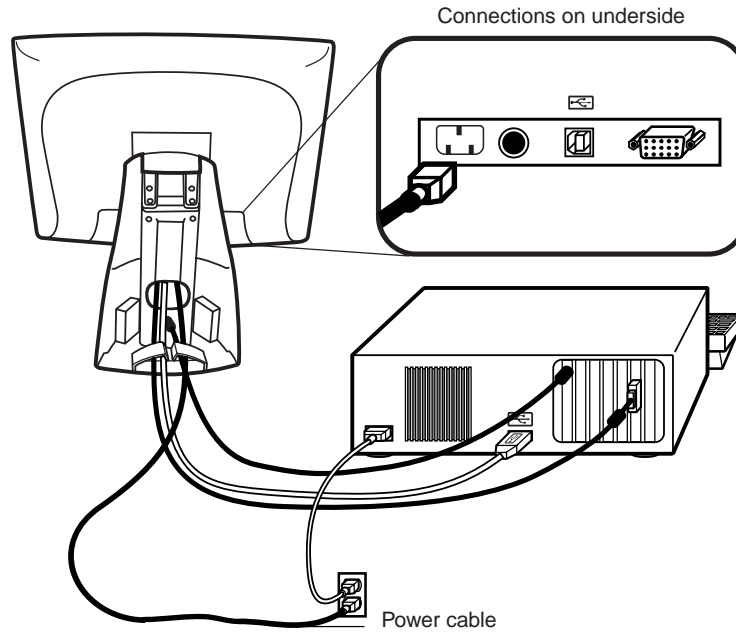

Depending on where you live, you will use either the European or US/Canadian power cable.

- Connect the female end of the power cable into the power port on the touchmonitor.
- Route the cable through the cable management clip.

NOTE: To protect your equipment against risk of damage from electrical surges in the power line, plug the touchmonitor's power cord into a surge protector, and then connect the surge protector to a grounded AC electrical outlet.

STEP 6-Replacing the Back Cover

When all the cables have been connected:

- Put the back stand cover on.
- Power on your PC then your touchmonitor. After a brief pause the picture should appear.

Optimizing the LCD Display

To ensure the LCD display works well with your computer, configure the display mode of your graphic card to make it less than or equal to 1024 x 768 resolution, and make sure the timing of the display mode is compatible with the LCD display. Refer to Appendix A for more information about resolution. Compatible video modes for your touchmonitor are listed in Appendix C.

VESA Mount on Your Touchmonitor

Your touchmonitor conforms to the VESA Flat Panel Monitor Physical Mounting Interface (FPMPMI™) Standard which defines a physical mounting interface for flat panel monitors, and corresponding standards for flat panel monitor mounting devices, such as wall and table arms. The VESA mounting interface is located on the back of your touchmonitor and is shipped pre-connected to the base.

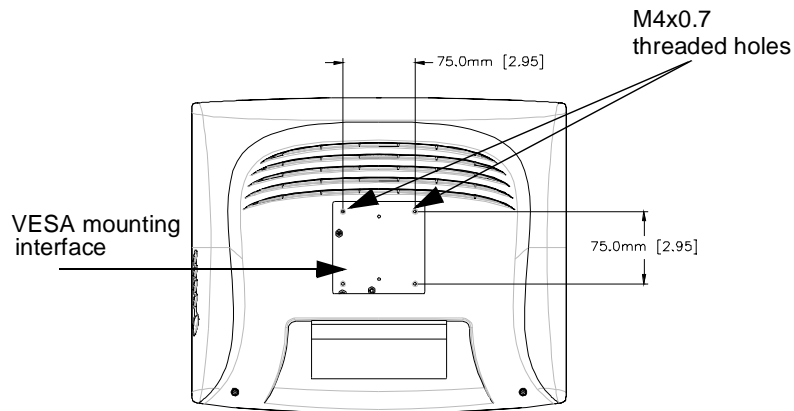

NOTE: The above drawing displays the VESA mounting interface after the removal of the mounting cover and base.

Accessing the VESA Mounting Interface

If you want to convert your desktop monitor to a wall mount or kiosk monitor, follow the steps below to access the VESA mounting interface.

NOTE: You will need a screwdriver for the following steps.

- 1** Remove the back cover of the stand by pulling forward on the bottom cut-out.
- 2** Carefully lay the monitor face down. At the top of the mounting screw cover there are two slots. With a screwdriver, pry open the mounting screw cover. The cover fit is tight so remove it carefully.
- 3** When you remove the mounting screw cover, you will see four screws. Remove the screws to mount your monitor. Refer to the drawing on page 18.

The following companies provide VESA mounting devices compatible with your touchmonitor:

Ergotron
800-888-8458
651-681-7600
www.ergotron.com

GCX
800-228-2555
707-773-1100
www.gcx.com

Innovative Office Products
800-524-2744
610-253-9554
www.innov-office-prod.com

MRI
800-688-2414
www.mediarecovery.com

Mounting the Base

You can also mount your touchmonitor by using the keyholes in the base of the stand. These keyholes provide easy slide on mounting. You can also bolt your touchmonitor to a tabletop or other flat surface. Please refer to Appendix C for location and dimension of the mounting holes.

Installing the Driver Software

Elo TouchSystems provides driver software that allows your touchmonitor to work with your computer. Drivers are located on the enclosed CD-ROM for the following operating systems:

- Windows XP
- Windows 2000
- Windows Me
- Windows 98
- Windows 95
- Windows NT 4.0

Additional drivers and driver information for other operating systems (including MS DOS, Windows 3.x, OS/2, Macintosh and Linux) are available on the Elo TouchSystems web site at www.elotouch.com.

Your Elo touchmonitor is plug-and-play compliant. Information on the video capabilities of your touchmonitor is sent to your video display adapter when Windows starts. If Windows detects your touchmonitor, follow the instructions on the screen to install a generic plug-and-play monitor.

Refer to the appropriate following section for driver installation instructions.

Installing the Serial Touch Driver for Windows XP, Windows 2000¹, Me, 95/98 and NT 4.0

NOTE: For Windows 2000 and NT 4.0 you must have administrator access rights to install the driver.

1 Insert the Elo CD-ROM in your computer's CD-ROM drive.

If the AutoStart feature for your CD-ROM drive is active, the system automatically detects the CD and starts the setup program.

2 Follow the directions on the screen to complete the driver setup for your version of Windows.

If the AutoStart feature is not active:

1 Click **Start > Run**.

2 Click the **Browse** button to locate the EloCd.exe program on the CD-ROM.

3 Click **Open**, then **OK** to run EloCd.exe.

4 Follow the directions on the screen to complete the driver setup for your version of Windows.

¹.To install Windows 2000 and Windows XP, you must use the "update driver" method; you will not find a setup.exe file within the download.

Installing the Serial Touch Driver for MS-DOS and Windows 3.1

You must have a DOS mouse driver (MOUSE.COM) installed for your mouse if you wish to continue using your mouse along with your touchmonitor in DOS.

To install Windows 3.x and MS-DOS from Windows 95/98, follow the directions below:

- 1 Insert the Elo CD-ROM in your computer's CD-ROM drive.
- 2 From DOS, type `d:\EloDos_W31` to change to the correct directory on the CD-ROM (your CD-ROM drive may be mapped to a different drive letter).
- 3 Type `install` and press **Enter** to start the installation.
- 4 Align the touchscreen.

You must have already completed Steps 1 and 2 before proceeding. Refer to Chapter 2 of the Elo DOS and Windows Driver Guide as necessary for additional installation information.

To run the INSTALL program:

- 1 Type `INSTALL` at the DOS prompt in the directory containing the driver install files.
- 2 `INSTALL` asks you to select the software to install. Then choose `d:\EloDos_W31` from the displayed list.
- 3 `INSTALL` also asks you for the paths to use during installation, or you may use its defaults. `INSTALL` creates directories as necessary, and warns you if they exist.

If you are updating your software, you may wish to specify the paths containing the earlier versions, and overwrite the obsolete files. All executable programs are upward compatible. For a list of differences from each previous version of the drivers, be sure to select "Differences from Previous Versions" during the installation process.

`INSTALL` updates your `AUTOEXEC.BAT` file with the drivers you select. `INSTALL` makes a copy of your original `AUTOEXEC.BAT` file, called `AUTOEXEC.OLD`. If you already have Elo driver commands in your `AUTOEXEC.BAT` file, they will be commented out.

When `INSTALL` is finished, it leaves a file called `GO.BAT` in the subdirectory you specified. `GO` loads the touchscreen driver, runs the calibration program `ELOCALIB`, and gives you some final instructions.

If you are using Windows 3.1, you will also calibrate the touchscreen within Windows 3.1 with the Touchscreen Control Panel.

Installing the USB Touch Driver

Installing the USB Touch Driver for Windows XP, Windows 2000, Me and 98

- 1 Insert the Elo CD-ROM in your computer's CD-ROM drive.
If Windows 98 or Windows 2000 starts the Add New Hardware Wizard:
 - 2 Choose **Next**. Select "Search for the best driver for your device (Recommended)" and choose **Next**.
 - 3 When a list of search locations is displayed, place a checkmark on "Specify a location" and use **Browse** to select the \EloUSB directory on the Elo CD-ROM.
 - 4 Choose **Next**. Once the Elo TouchSystems USB touchscreen driver has been detected, choose **Next** again.
 - 5 You will see several files being copied. Insert your Windows 98 CD if prompted. Choose **Finish**.

If Windows 98 or Windows 2000 does not start the Add New Hardware Wizard:

NOTE: For Windows 2000 you must have administrator access rights to install the driver.

- 1 Insert the Elo CD-ROM in your computer's CD-ROM drive.
If the AutoStart feature for your CD-ROM drive is active, the system automatically detects the CD and starts the setup program.
- 2 Follow the directions on the screen to complete the driver setup for your version of Windows.

If the AutoStart feature is not active:

- 1 Click **Start > Run**.
- 2 Click the **Browse** button to locate the EloCd.exe program on the CD-ROM.
- 3 Click **Open**, then **OK** to run EloCd.exe.
- 4 Follow the directions on the screen to complete the driver setup for your version of Windows.

To install Windows 2000 and Windows XP, you must use the "update driver" method; you will not find a setup.exe file within the download

About Touchmonitor Adjustments

Your touchmonitor will unlikely require adjustment. Variations in video output and application may require adjustments to your touchmonitor to optimize the quality of the display.

For best performance, your touchmonitor should be operating in native resolution, that is 1024 x 768 at 60-75 Hz. Use the Display control panel in Windows to choose 1024 x 768 resolution.

Operating in other resolutions will degrade video performance. For further information, please refer to Appendix A.

All adjustments you make to the controls are automatically memorized. This feature saves you from having to reset your choices every time you unplug or power your touchmonitor off and on. If there is a power failure your touchmonitor settings will not default to the factory specifications.

Using the On-Screen Display (OSD) Menus

All adjustments are made by using the on-screen display (OSD) menus. All menu items can be selected by using the buttons on the side bezel.

NOTE: OSD menu default is enabled.

Side Bezel Buttons

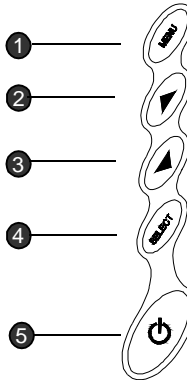

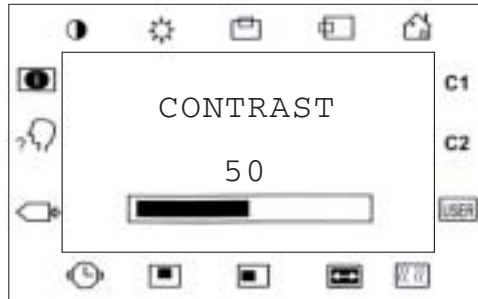

	Control	Function
① MENU	Menu	Display on exit the OSD menus.
② ↗	Contrast/ Up/Toggle	1. Shortcut to Contrast adjustment 2. Increase value of adjustment items 3. With menu on toggles OSD options
③ ↘	Volume/Down Toggle	1. Shortcut to Volume adjustment 2. Decrease value of the adjustment items 3. With menu on toggles OSD options
④ SELECT	Enter Select item	1. Shortcut to Auto Adjust 2. Select- To select the adjustment items from the OSD menus. 3. Auto- To activate the “Auto Adjustment” function to obtain an optimum image.
⑤ ⏻	Power Switch	Switches the power on/off to your touchmonitor.
	Enable/Disable	1. Press the Up and Down buttons at the same time to enable/disable the MUTE functions. OSD menu default is enabled 2. Press the Menu and Up buttons at the same time and hold for two seconds to enable/disable the OSD functions. OSD menu default is enabled. 3. Press the Menu and Down buttons at the same time and hold for two seconds to enable/disable the power lock function. OSD menu default is enabled.

OSD Menu Function





 **Contrast**
Controls the picture contrast

 **Brightness**
Controls the picture brightness

 **V-Position**
Controls the vertical position

 **H-Position**
Controls the horizontal position

 **Recall Defaults**
Recalls factory settings of the image parameters

 **C1/C2/USER (Color)**
Using these icons, you can select one of the preset color temperatures (9300°K or 6500°K). Confirm your choice by pressing the **SELECT** button. If you want to change the color temperatures individually, select **USER** and confirm by pressing the OSD button **SELECT**. Now you can use the OSD dial to toggle between the settings R, G and B (red, green and blue foreground). To change a setting, first press the **SELECT** button, then choose the desired value with the OSD dial. To confirm the setting, press the **SELECT** button again.

If you don't need to adjust any further settings, choose the  icon to return to the OSD main menu.

 **Phase**
Controls the vertical fine adjustment

 **Clock**
Controls the horizontal fine adjustment

 **OSD H-Position**
Adjusts the horizontal position of the OSD menu

 **OSD V-Position**
Adjust the vertical position of the OSD menu

 **OSD Time**
Determines how long (in seconds) the OSD menu waits before closing automatically after no action has been performed.

 **Auto Adjust**
Automatically selects the optional settings for image parameters (brightness, contrast, image position, phase, etc.)

 **OSD Language**
Selection of the OSD menu language: English, French, German, Spanish, Japanese.

 **Image Information**
Displays the current graphics mode.

TROUBLESHOOTING

If you are experiencing trouble with your touchmonitor, refer to the following table. If the problem persists, please contact your local dealer or our service center.

Solutions to Common Problems

Problem	Suggestion(s)
No image appears on screen.	<p>Check that all the I/O and power connectors are properly connected as described in Chapter 2.</p> <p>Make sure the pins of the connectors are not crooked or broken.</p> <p>Test power supply by trying different cables, a different wall outlet or plug another appliance into the outlet.</p> <p>Make certain the video cable is properly connected and that it is not damaged. Check for bent pins on the cable connectors.</p> <p>Ensure that your computer and video card are properly configured. (Consult video card documentation.)</p>
“Out of Range” display	<p>Check to see if the resolution of your computer is higher than that of the LCD display.</p> <p>Reconfigure the resolution of your computer to make it less than or equal to 1024 x 768. See Appendix A for more information on resolution.</p>

Image has vertical flickering line bars.	Use "PHASE" to make an adjustment. Check and reconfigure the display mode of the vertical refresh rate of your graphic card to make it compatible with the LCD display.
Image is unstable and flickering	Use "CLOCK" to make an adjustment.
Image is scrolling	Make sure the VGA signal cable (or adapter) is well connected. Check and reconfigure the display mode of the vertical refresh rate of your graphic card to make it compatible with the LCD display.
Touch doesn't work	Make sure cable is securely attached at both ends.



NATIVE RESOLUTION

The native resolution of a monitor is the resolution level at which the LCD panel is designed to perform best. For the Elo LCD touchmonitor, the native resolution is 1024 x 768 for the XGA-15 inch size. In almost all cases, screen images look best when viewed at their native resolution. You can lower the resolution setting of a monitor but not increase it.

Input Video	15" LCD
640x480 (VGA)	Transforms input format to 1024x768
800x600 (SVGA)	Transforms input format to 1024x768
1024x768 (XGA)	Displays in Native Resolution

The native resolution of an LCD is the actual number of pixels horizontally in the LCD by the number of pixels vertically in the LCD. LCD resolution is usually represented by the following symbols:

VGA	640x480
SVGA	800x600
XGA	1024x768
SXGA	1280x1024
UXGA	1600x1200

As an example, a SVGA resolution LCD panel has 800 pixels horizontally by 600 pixels vertically. Input video is also represented by the same terms. XGA input video has a format of 1024 pixels horizontally by 768 pixels vertically. When the input pixels contained in the video input format match the native resolution of the panel, there is a one to one correspondence of mapping of input video pixels to LCD pixels. As an example, the pixel in column 45 and row 26 of the input video is in column 45 and row 26 of the LCD. For the case when the input video is at a lower resolution than the native resolution of the LCD, the direct correspondence between the video pixels and the LCD pixels is lost. The LCD controller can compute the correspondence between video pixels and LCD pixels using algorithms contained on its controller. The accuracy of the algorithms determines the fidelity of conversion of video pixels to LCD pixels. Poor fidelity conversion can result in artifacts in the LCD displayed image such as varying width characters.

B

TOUCHMONITOR SAFETY

This manual contains information that is important for the proper setup and maintenance of your touchmonitor. Before setting up and powering on your new touchmonitor, read through this manual, especially Chapter 2 (Installation), and Chapter 3 (Operation).

- 1** To reduce the risk of electric shock, follow all safety notices and never open the touchmonitor case.
- 2** Turn off the product before cleaning
- 3** Your new touchmonitor is equipped with a 3-wire, grounding power cord. The power cord plug will only fit into a grounded outlet. Do not attempt to fit the plug into an outlet that has not been configured for this purpose. Do not use a damaged power cord. Use only the power cord that comes with your Elo TouchSystems Touchmonitor. Use of an unauthorized power cord may invalidate your warranty.
- 4** The slots located on the sides and top of the touchmonitor case are for ventilation. Do not block or insert anything inside the ventilation slots.
- 5** It is important that your touchmonitor remains dry. Do not pour liquid into or onto your touchmonitor. If your touchmonitor becomes wet do not attempt to repair it yourself.

Care and Handling of Your Touchmonitor

The following tips will help keep your Elo Entuitive touchmonitor functioning at the optimal level.

- To avoid risk of electric shock, do not disassemble the brick supply or display unit cabinet. The unit is not user serviceable. Remember to unplug the display unit from the power outlet before cleaning.
- Do not use alcohol (methyl, ethyl or isopropyl) or any strong dissolvent. Do not use thinner or benzene, abrasive cleaners or compressed air.
- To clean the display unit cabinet, use a cloth lightly dampened with a mild detergent.
- Avoid getting liquids inside your touchmonitor. If liquid does get inside, have a qualified service technician check it before you power it on again.
- Do not wipe the screen with a cloth or sponge that could scratch the surface.
- To clean the touchscreen, use window or glass cleaner. Put the cleaner on the rag and wipe the touchscreen. *Never* apply the cleaner directly on the touchscreen



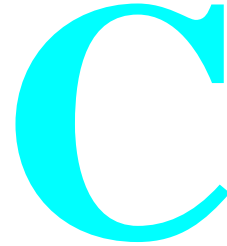

TECHNICAL SPECIFICATIONS

Compatible Video Modes

Your Elo Entuitive touchmonitor is compatible with the following standard video modes:

Mode	Resolution	H. Frequency (kHz)	V. Frequency (Hz)
IBM & VESA VGA	640 x 350	31.47	70.09
IBM & VESA VGA	640 x 400	31.47	70.09
IBM & VESA VGA	720 x 400	31.47	70.09
IBM & VESA VGA	640 x 480	31.47	59.94
IBM & VESA VGA	640 x 480	37.86	72.81
IBM & VESA VGA	640 x 480	37.50	75.00
VESA SVGA	800 x 600	35.16	56.25
VESA SVGA	800 x 600	37.88	60.32
VESA SVGA	800 x 600	48.08	72.19
VESA SVGA	800 x 600	46.88	75.00
VESA XGA	1024 x 768	48.36	60.00
VESA XGA	1024 x 768	56.48	70.07
VESA XGA	1024 x 768	60.02	75.03
Apple Macintosh LC 13"	640 x 480	34.97	66.61
Apple Macintosh II 13"	640 x 480	35.00	66.67
Apple Macintosh 16"	832 x 624	49.73	74.55
Apple Macintosh 19"	1024 x 768	60.24	75.02
NEC FC-98 series	640 x 400	24.83	56.42
NEC FC-98 series	640 x 400	31.47	70.01
NEC FC-98 series	640 x 480	31.47	59.94

Touchmonitor Specifications

Table C.1 15" LCD Touchmonitor (ET15-XXWA-1) Specifications

Display Type	Active matrix, thin film transistor (TFT), liquid crystal display	
Size	15-inch diagonal 304.1 x 228.1 mm useful screen area	
Pixel Format	1024 x 768	
Touchscreen	0.125-inch IntelliTouch and AccuTouch, anti-glare IntelliTouch or AccuTouch	
Colors	16 million with dithering	
Display Brightness	IntelliTouch: 270 cd/m ² typical	AccuTouch: 250 cd/m ² typical
Back-light Lamp Life	25,000 hours at 50% brightness typical	
Viewing Angle	Horizontal	±65 or 120 degrees total
	Vertical	±60-45 or 105 degrees total
Contrast Ratio	450:1 typical	
Display Response Time	13 ms (tr) /27 ms (tf)	
Environmental	Operating Temp	0°C to 40°C
	Storage Temp	-25°C to +60°C
	Humidity	80% non-condensing AT 95% IT
Mechanical	Weight	17 lbs. maximum approx. weight for IntelliTouch and AccuTouch
	Size	See drawings on next page.
Electrical	Input Video	VGA/SVGA/XGA analog video
	Input Power	100-240 VAC, 50/60 Hz.
	Power Dissipation	Universal
Speakers	8 ohms, 1 watt per speaker	
Agencies	Safety & EMC	UL, cUL and TUV-GS, FCC-B, CE, C-Tick and VCCI

Table C.2 IntelliTouch Touchmonitor Specifications

Mechanical	
Positional Accuracy	Standard deviation of error is less than 0.080 in. (2.03 mm). Equates to less than $\pm 1\%$.
Touchpoint Density	More than 100,000 touchpoints/in ² (15,500 touchpoints/cm ²).
Touch Activation Force	Typically less than 3 ounces (85 grams).
Surface Durability	Surface durability is that of glass, Mohs' hardness rating of 7.
Expected Life Performance	No known wear-out mechanism, as there are no layers, coatings, or moving parts. IntelliTouch technology has been operationally tested to more than 50 million touches in one location without failure, using a stylus similar to a finger.
Sealing	Unit is sealed to protect against splashed liquids, dirt, and dust.
Optical	
Light Transmission (per ASTM D1003)	90%
Visual Resolution	All measurements made using USAF 1951 Resolution Chart, under 30X magnification, with test unit located approximately 1.5 in (38 mm) from surface of resolution chart. Clear surface: Excellent, with no noticeable degradation. Antiglare surface: 6:1 minimum.
Gloss (per ASTM D2457 using a 60-degree gloss meter)	Antiglare surface: Curved: 60 ± 20 gloss units or 75 ± 15 gloss units.

Environmental

Chemical Resistance The active area of the touchscreen is resistant to all chemicals that do not affect glass, such as:

- Acetone
- Toluene
- Methyl ethyl ketone
- Isopropyl alcohol
- Methyl alcohol
- Ethyl acetate
- Ammonia-based glass cleaners
- Gasoline
- Kerosene
- Vinegar

Electrostatic Protection (per EN 61000-4-2, 1995)

Meets Level 4 (15 kV air/8 kV contact discharges).

Table C.3 AccuTouch Touchmonitor Specifications

Mechanical	
Construction	Top: Polyester with outside hard-surface coating with clear or antiglare finish. Inside: Transparent conductive coating. Bottom: Glass substrate with uniform resistive coating. Top and bottom layers separated by Elo-patented separator dots.
Positional Accuracy	Standard deviation of error is less than 0.080 in. (2.03 mm). This equates to less than $\pm 1\%$.
Touchpoint Density	More than 100,000 touchpoints/in ² (15,500 touchpoints/cm ²).
Touch Activation Force	Typically less than 4 ounces (113 grams).
Surface Durability	Meets Taber Abrasion Test (ASTM D1044), CS-10F wheel, 500 g. Meets pencil hardness 3H.
Expected Life Performance	AccuTouch technology has been operationally tested to greater than 35 million touches in one location without failure, using a stylus similar to a finger.
Optical	
Light Transmission (per ASTM D1003)	Typically 75% at 550-nm wavelength (visible light spectrum).
Visual Resolution	All measurements made using USAF 1951 Resolution Chart, under 30 X magnification, with test unit located approximately 1.5 in. (38 mm) from surface of resolution chart. Antiglare surface: 6:1 minimum.
Haze (per ASTM D1003)	Antiglare surface: Less than 15%.
Gloss (per ASTM D2457)	Antiglare surface: 90 \pm 20 gloss units tested on a hard-coated front surface.

15" LCD Touchmonitor (ET15-XXWA-1) Dimensions

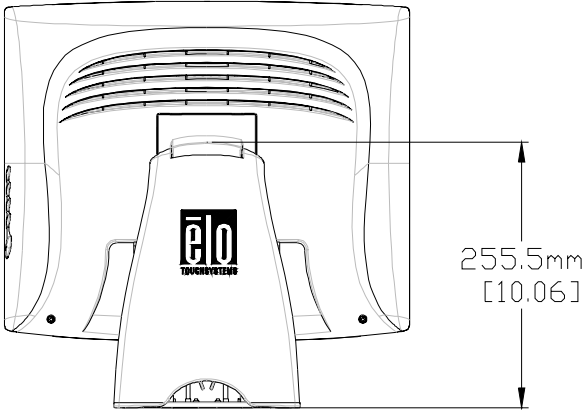
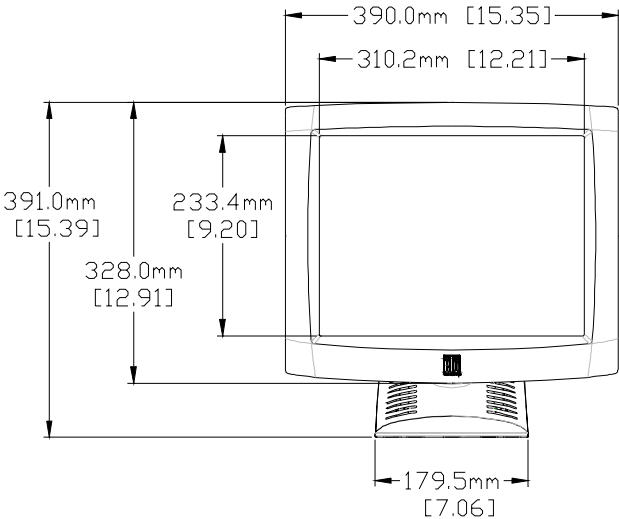

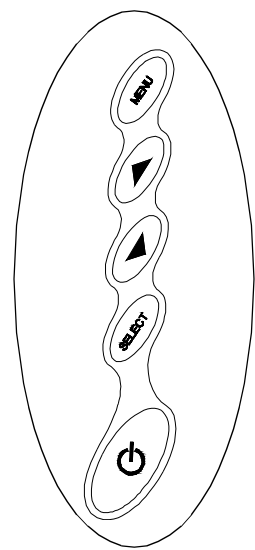
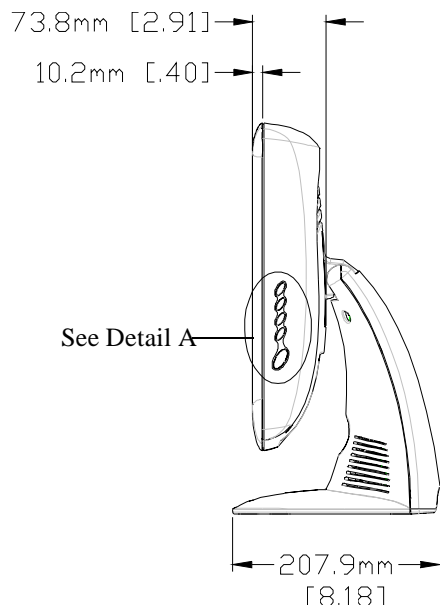

Detail A

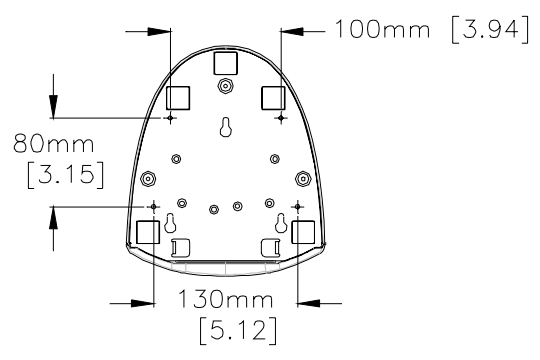

REGULATORY INFORMATION

I. Electrical Safety Information:

A) Compliance is required with respect to the voltage, frequency, and current requirements indicated on the manufacturer's label. Connection to a different power source than those specified herein will likely result in improper operation, damage to the equipment or pose a fire hazard if the limitations are not followed.

B) There are no operator serviceable parts inside this equipment. There are hazardous voltages generated by this equipment which constitute a safety hazard. Service should be provided only by a qualified service technician.

C) This equipment is provided with a detachable power cord which has an integral safety ground wire intended for connection to a grounded safety outlet.

1) Do not substitute the cord with other than the provided approved type. Under no circumstances use an adapter plug to connect to a 2-wire outlet as this will defeat the continuity of the grounding wire.

2) The equipment requires the use of the ground wire as a part of the safety certification, modification or misuse can provide a shock hazard that can result in serious injury or death.

3) Contact a qualified electrician or the manufacturer if there are questions about the installation prior to connecting the equipment to mains power.

II. Emissions and Immunity Information

A) Notice to Users in the United States: This equipment has been tested and found to comply with the limits for a Class B digital device, pursuant to Part 15 of FCC Rules. These limits are designed to provide reasonable protection against harmful interference in a residential installation. This equipment generates, uses, and can radiate radio frequency energy, and if not installed and used in accordance with the instructions, may cause harmful interference to radio communications.

B) Notice to Users in Canada: This equipment complies with the Class B limits for radio noise emissions from digital apparatus as established by the Radio Interference Regulations of Industrie Canada.

C) Notice to Users in the European Union: Use only the provided power cords and interconnecting cabling provided with the equipment. Substitution of provided cords and cabling may compromise electrical safety or CE Mark Certification for emissions or immunity as required by the following standards:

This Information Technology Equipment (ITE) is required to have a CE Mark on the manufacturer's label which means that the equipment has been tested to the following Directives and Standards:

This equipment has been tested to the requirements for the CE Mark as required by EMC Directive 89/336/EEC indicated in European Standard EN 55 022 Class B and the Low Voltage Directive 73/23/EEC as indicated in European Standard EN 60 950.

D) General Information to all Users: This equipment generates, uses and can radiate radio frequency energy. If not installed and used according to this manual the equipment may cause interference with radio and television communications. There is, however, no guarantee that interference will not occur in any particular installation due to site-specific factors.

1) In order to meet emission and immunity requirements, the user must observe the following:

- a) Use only the provided I/O cables to connect this digital device with any computer.
- b) To ensure compliance, use only the provided manufacturer's approved line cord.
- c) The user is cautioned that changes or modifications to the equipment not expressly approved by the party responsible for compliance could void the user's authority to operate the equipment.

2) If this equipment appears to cause interference with radio or television reception, or any other device:

- a) Verify as an emission source by turning the equipment off and on.
- b) If you determine that this equipment is causing the interference, try to correct the interference by using one or more of the following measures:
 - i) Move the digital device away from the affected receiver.
 - ii) Reposition (turn) the digital device with respect to the affected receiver.
 - iii) Reorient the affected receiver's antenna.
 - iv) Plug the digital device into a different AC outlet so the digital device and the receiver are on different branch circuits.
 - v) Disconnect and remove any I/O cables that the digital device does not use. (Unterminated I/O cables are a potential source of high RF emission levels.)
 - vi) Plug the digital device into only a grounded outlet receptacle. Do not use AC adapter plugs. (Removing or cutting the line cord ground may increase RF emission levels and may also present a lethal shock hazard to the user.)

If you need additional help, consult your dealer, manufacturer, or an experienced radio or television technician.

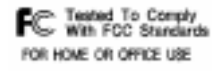

N10051

WARRANTY

Except as otherwise stated herein or in an order acknowledgment delivered to Buyer, Seller warrants to Buyer that the Product shall be free of defects in materials and workmanship. The warranty for the touchmonitors and components of the product is 1 year.

Seller makes no warranty regarding the model life of components. Seller's suppliers may at any time and from time to time make changes in the components delivered as Products or components.

Buyer shall notify Seller in writing promptly (and in no case later than thirty (30) days after discovery) of the failure of any Product to conform to the warranty set forth above; shall describe in commercially reasonable detail in such notice the symptoms associated with such failure; and shall provide to Seller the opportunity to inspect such Products as installed, if possible. The notice must be received by Seller during the Warranty Period for such product, unless otherwise directed in writing by the Seller. Within thirty (30) days after submitting such notice, Buyer shall package the allegedly defective Product in its original shipping carton(s) or a functional equivalent and shall ship to Seller at Buyer's expense and risk.

Within a reasonable time after receipt of the allegedly defective Product and verification by Seller that the Product fails to meet the warranty set forth above, Seller shall correct such failure by, at Seller's options, either (i) modifying or repairing the Product or (ii) replacing the Product. Such modification, repair, or replacement and the return shipment of the Product with minimum insurance to Buyer shall be at Seller's expense. Buyer shall bear the risk of loss or damage in transit, and may insure the Product. Buyer shall reimburse Seller for transportation cost incurred for Product returned but not found by Seller to be defective. Modification or repair, of Products may, at Seller's option, take place either at Seller's facilities or at Buyer's premises. If Seller is unable to modify, repair, or replace a Product to conform to the warranty set forth above, then Seller shall, at Seller's option, either refund to Buyer or credit to Buyer's account the purchase price of the Product less depreciation calculated on a straight-line basis over Seller's stated Warranty Period.

THESE REMEDIES SHALL BE THE BUYER'S EXCLUSIVE REMEDIES FOR BREACH OF WARRANTY. EXCEPT FOR THE EXPRESS WARRANTY SET FORTH ABOVE, SELLER GRANTS NO OTHER WARRANTIES, EXPRESS OR IMPLIED BY STATUTE OR OTHERWISE, REGARDING THE PRODUCTS, THEIR FITNESS FOR ANY PURPOSE, THEIR QUALITY, THEIR MERCHANTABILITY, THEIR NONINFRINGEMENT, OR OTHERWISE. NO EMPLOYEE OF SELLER OR ANY OTHER PARTY IS AUTHORIZED TO MAKE ANY WARRANTY FOR THE GOODS OTHER THAN THE WARRANTY SET FORTH HEREIN. SELLER'S LIABILITY UNDER THE WARRANTY SHALL BE LIMITED TO A REFUND OF THE PURCHASE PRICE OF THE PRODUCT. IN NO EVENT SHALL SELLER BE LIABLE FOR THE COST OF PROCUREMENT OR INSTALLATION OF SUBSTITUTE GOODS BY BUYER OR FOR ANY SPECIAL, CONSEQUENTIAL, INDIRECT, OR INCIDENTAL DAMAGES.

Buyer assumes the risk and agrees to indemnify Seller against and hold Seller harmless from all liability relating to (i) assessing the suitability for Buyer's intended use of the Products and of any system design or drawing and (ii) determining the compliance of Buyer's use of the Products with applicable laws, regulations, codes, and standards. Buyer retains and accepts full responsibility for all warranty and other claims relating to or arising from Buyer's products, which include or incorporate Products or components manufactured or supplied by Seller. Buyer is solely responsible for any and all representations and warranties regarding the Products made or authorized by Buyer. Buyer will indemnify Seller and hold Seller harmless from any liability, claims, loss, cost, or expenses (including reasonable attorney's fees) attributable to Buyer's products or representations or warranties concerning same.

INDEX

Numerics

- 15" LCD Touchmonitor (ET15-XXWA-1) Dimensions, 40
- 15" LCD Touchmonitor (ET15-XXWA-1) Specifications, 36

A

- About the Product, 1
- About Touchmonitor Adjustments, 25
- Accessing the VESA Mounting Interface, 19
- AccuTouch Touchmonitor Specifications, 39
- Agencies, 36
- Auto Adjust, 27

B

- Back-light Lamp Life, 36
- Base Bottom View, 5
- Brightness, 27

C

- C1/C2/USER (Color), 27
- Care and Handling of Your Touchmonitor, 34
- Chemical Resistance, IntelliTouch, 38
- Cleaning Your Touchmonitor, 34
- Clock, 27
- Colors, 36
- Compatible Video Modes, 35
- Connecting the Power Cable, 11, 17
- Connecting the Serial Touchscreen Cable, 9
- Connecting the Speaker Cable, 10, 16
- Connecting the USB Touchscreen Cable, 15
- Connecting the Video Cable, 8, 14
- Construction, AccuTouch, 39
- Contrast, 26, 27
- Contrast Ratio, 36

D

- Display Brightness, 36
- Display Response Time, 36
- Display Type, 36

E

- Electrical, 36
- Electrical Safety Information, 43
- Electrostatic Protection, IntelliTouch, 38
- Emissions and Immunity Information, 43
- Enable/Disable, 26
- Environmental, 36, 38

- Expected Life Performance, AccuTouch, 39
- Expected Life Performance, IntelliTouch, 37

G

- Gloss, AccuTouch, 39
- Gloss, IntelliTouch, 37

H

- Haze, AccuTouch, 39
- H-Position, 27

I

- Image Information, 27
- Image problem, 29
- Image, scrolling, 30
- Image, unstable, 30
- Image, vertical flickering, 30
- Installation and Setup, 3
- Installing the Driver Software, 20
- Installing the Serial Touch Driver, 21
- Installing the Serial Touch Driver for MS-DOS and Windows 3.1, 22
- Installing the Serial Touch Driver for Windows 2000, Me, 95/98 and NT 4.0, 21
- Installing the USB Touch Driver, 23
- Installing the USB Touch Driver for Windows 2000, Me and 98, 23
- IntelliTouch Touchmonitor Specifications, 37
- Introduction, 1

L

- Light Transmission, AccuTouch, 39
- Light Transmission, IntelliTouch, 37

M

- Main Unit, 4
- Mechanical, 36
- Mechanical, AccuTouch, 39
- Mechanical, IntelliTouch, 37
- Menu, 26
- Minus Counter-clockwise, 26
- Mounting the Base, 19

N

- Native Resolution, 31



O

- Operation, 25
- Optical, AccuTouch, 39
- Optical, IntelliTouch, 37
- Optimizing the LCD Display, 18
- OSD H-Position, 27
- OSD Language, 27
- OSD Menu Function, 27
- OSD Time, 27
- OSD V-Position, 27
- Out of Range display, 29

P

- Phase, 27
- Pixel Format, 36
- Plus/Clockwise, 26
- Positional Accuracy, AccuTouch, 39
- Positional Accuracy, IntelliTouch, 37
- Power Switch, 26
- Precautions, 1
- Product Overview, 4

R

- Rear View, 4
- Recall Defaults, 27
- Regulatory Information, 43
- Removing the Back Cover, 7, 13
- Replacing the Back Cover, 11, 17

S

- Sealing, IntelliTouch, 37
- Serial Connection, 6
- Side Bezel Buttons, 26
- Side View, 5
- Solutions to Common Problems, 29
- Speakers, 36
- Surface Durability, AccuTouch, 39
- Surface Durability, IntelliTouch, 37
- SVGA, 31
- SXGA, 31

T

- Technical Specifications, 35
- Touch Activation Force, AccuTouch, 39
- Touch Activation Force, IntelliTouch, 37
- Touch Interface Connection, 6
- Touch not working, 30

- Touchmonitor Safety, 33
- Touchmonitor Specifications, 36
- Touchpoint Density, AccuTouch, 39
- Touchpoint Density, IntelliTouch, 37
- Troubleshooting, 29



U

- Unpacking Your Touchmonitor, 3
- USB Connection, 12
- Using the On-Screen Display (OSD) Menus, 25
- UXGA, 31

V

- VESA Mount on Your Touchmonitor, 18
- VGA, 31
- Viewing Angle, 36
- Visual Resolution, AccuTouch, 39
- Visual Resolution, IntelliTouch, 37
- Volume, 26
- V-Position, 27

W

- Warranty, 47

X

- XGA, 31

PORT POWERED SWIPE READER TECHNICAL REFERENCE MANUAL

Manual Part Number 99875094 Rev 10

JULY 2001

MAGTEK

20725 South Annalee Avenue
Carson, CA 90746
Phone: (310) 631-8602
FAX: (310) 631-3956
Technical Support: (888) 624-8350
www.magtek.com

Information in this document is subject to change without notice. No part of this document may be reproduced or transmitted in any form or by any means, electronic or mechanical, for any purpose, without the express written permission of Mag-Tek, Inc.

Mag-Tek is a registered trademark of Mag-Tek, Inc.
Procomm is a registered trademark of Datastorm Technologies, Inc.

REVISIONS

Rev Number	Date	Notes
1	11 Dec 97	Initial Release
2	18 Dec 97	Sec 1 Changed spec Dimensions; Sec 1, 3 Changed illustrations for clarity.
3	11 May 98	Sections 1, 2, and 3 revised to reflect latest firmware revisions. Sec 4 deleted.
4	15 Jun 98	Two part numbers added.
5	1 Mar 99	Sec 1, Added 3 part numbers, changed specs, Changed Dimensions Figure 1-3, removed Figure 1-4, Mounting Dimensions, added Mag-Tek Windows Drivers; Added note to Table 1-1. Section 2, added mounting instructions and Figure 2-1, Mounting Dimensions. Section 3, added 3 track symbols to Table 3-1 and 3 sign-on configurations to 3-2.
6	14 Jun 99	Title change, Removed MT-211 and RS-232; Sec 1, Table 1-1, added Pin List for Cable 21040077, added RS-232 Communication; Sec 2, added Demo Program from Net; Sec 3, Clarified Fig 3-1, Described firmware P/Ns and revisions.
7	1 Dec 99	Section 1: Added P/N 21040084, Updated table for 9- and 25-pin connectors; Section 3: Added P/N 21040084 to Sign-on table.
8	21 Sep 00	Editorial changes throughout. Sec 1: Configuration list expanded and moved to Sec 3; Specification weight changed from 5.9 oz to 5.8oz, Converted symbols to Metric System [SI]. Sec 3: Added 5 new part numbers with firmware, tracks, and configurations.
9	09 Mar 01	Front Matter: Corrected Agency Approvals to include Class B for FCC and Class B for CE. Changed RMA Warranty address to 20801 S. Annalee. Section 3: Removed "Track 3 – 7 bit" line from Table 3-1. Added 094 and 096 configurations in Table 3-2.
10	25 Jul 01	Front Matter: Agency Approvals: Corrected Class B for CE and Corrected UL and CUL . Copyright 2001 added.

Limited Warranty

Mag-Tek, Inc. (hereinafter "Mag-Tek") warrants this Mag-Tek product IN ITS ENTIRETY, to be in good working order for a period of one year from the date of purchase from Mag-Tek. Should this product fail to be in good working order at any time during this warranty period, Mag-Tek will, at its option, repair or replace this product at no additional charge except as set forth below. Repair parts and replacement products will be furnished on an exchange basis and will be either reconditioned or new. All replaced parts and products become the property of Mag-Tek. This limited warranty does not include service to repair damage to the product resulting from accident, disaster, misuse, abuse, or non-Mag-Tek modification of the product.

Limited Warranty service may be obtained by delivering the product during the warranty period to Mag-Tek (20801 S. Annalee Ave., Carson, CA 90746). If this product is delivered by mail, you agree to insure the product or assume the risk of loss or damage in transit, to prepay shipping charges to the warranty service location and to use the original shipping container or equivalent.

ALL EXPRESS AND IMPLIED WARRANTIES FOR THIS PRODUCT, INCLUDING THE WARRANTIES OF MERCHANTABILITY AND FITNESS FOR A PARTICULAR PURPOSE, ARE LIMITED IN DURATION TO A PERIOD OF ONE YEAR FROM THE DATE OF PURCHASE, AND NO WARRANTIES, WHETHER EXPRESS OR IMPLIED, WILL APPLY AFTER THIS PERIOD, EXCEPT AS PROVIDED IN THE PRECEDING SENTENCE. EACH PURCHASER UNDERSTANDS THAT THE MAG-TEK PRODUCT IS OFFERED AS IS.

IF THIS PRODUCT IS NOT IN GOOD WORKING ORDER AS WARRANTED ABOVE, YOUR SOLE REMEDY SHALL BE REPAIR OR REPLACEMENT AS PROVIDED ABOVE. IN NO EVENT WILL MAG-TEK BE LIABLE TO YOU FOR ANY DAMAGES, INCLUDING ANY LOST PROFITS, LOST SAVINGS OR OTHER INCIDENTAL OR CONSEQUENTIAL DAMAGES ARISING OUT OF THE USE OF OR INABILITY TO USE SUCH PRODUCT, EVEN IF MAG-TEK HAS BEEN ADVISED OF THE POSSIBILITY OF SUCH DAMAGES, OR FOR ANY CLAIM BY ANY OTHER PARTY.

THIS WARRANTY GIVES YOU SPECIFIC LEGAL RIGHTS, AND YOU MAY ALSO HAVE OTHER RIGHTS WHICH VARY FROM STATE TO STATE.

FCC WARNING STATEMENT

This equipment has been tested and found to comply with the limits for Class B digital device, pursuant to Part 15 of FCC Rules. These limits are designed to provide reasonable protection against harmful interference when the equipment is operated in a residential environment. This equipment generates, uses, and can radiate radio frequency energy and, if not installed and used in accordance with the instruction manual, may cause harmful interference to radio communications. However, there is no guarantee that interference will not occur in a particular installation.

FCC COMPLIANCE STATEMENT

This device complies with Part 15 of the FCC Rules. Operation of this device is subject to the following two conditions: (1) This device may not cause harmful interference; and (2) this device must accept any interference received, including interference that may cause undesired operation.

CANADIAN DOC STATEMENT

This digital apparatus does not exceed the Class B limits for radio noise for digital apparatus set out in the Radio Interference Regulations of the Canadian Department of Communications.

Le présent appareil numérique n'émet pas de bruits radioélectriques dépassant les limites applicables aux appareils numériques de la classe B prescrites dans le Règlement sur le brouillage radioélectrique édicté par le ministère des Communications du Canada.

CE STANDARDS

Testing for compliance to CE and FCC requirements was performed by an independent laboratory. The unit under test was found compliant to Class B.

UL/CSA

This product is recognized per Underwriter Laboratories and Canadian Underwriter Laboratories 1950.

TABLE OF CONTENTS

SECTION 1. FEATURES AND SPECIFICATIONS	57
MAG-TEK DEVICE DRIVERS FOR WINDOWS	57
FEATURES	57
CONFIGURATION	58
SPECIFICATIONS	59
SECTION 2. INSTALLATION	61
REQUIREMENTS	61
MOUNTING	61
INSTALLATION AND TEST	62
SECTION 3. OPERATION	65
LED INDICATOR	65
CARD READ	65
READER TO HOST MESSAGE FORMAT	65
TIMING FOR ID SIGN ON	66

FIGURES

Figure 1-1. Port-Powered Swipe Reader	58
Figure 1-2. Reader Cable and Optional Adapter	58
Figure 1-3. Dimensions	60
Figure 2-1. Mounting Hole Dimensions For Surface	62
Figure 3-1. Timing For ID Sign-on and Transmission Bursts.	66

TABLES

Table 1-1. OEM and 9-Pin Connectors and 25-Pin Adapter	58
Table 1-2. Specifications	59
Table 3-1. SS and ES Track Symbols	65
Table 3-2. Sign-on ID for Configurations	67

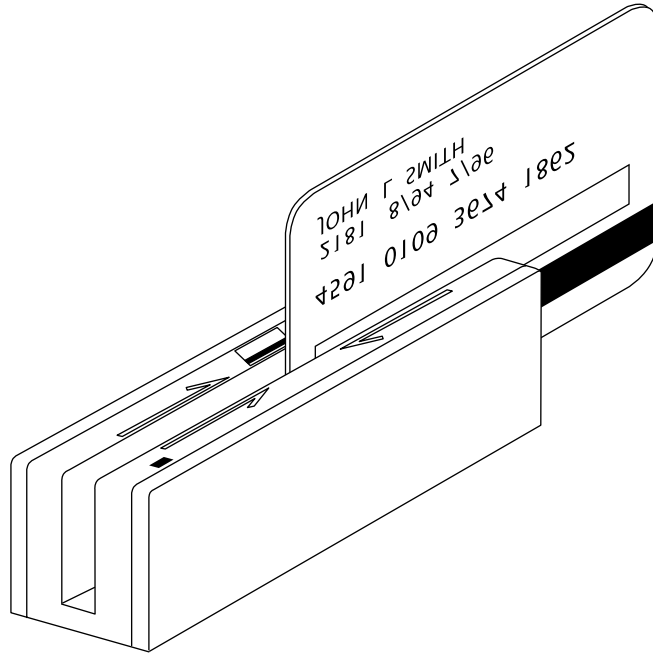

Figure 1-1. Port-Powered Swipe Reader

SECTION 1. FEATURES AND SPECIFICATIONS

The Port Powered Swipe Reader is a compact magnetic stripe card reader which conforms to ISO/ANSI standards. The Reader is compatible with the PC series of personal computers or any device with a serial RS-232 interface. A card is read by sliding it, stripe down and facing the LED side, through the slot either forward or backward.

A green LED (Light Emitting Diode) indicator on the Reader panel provides the operator with continuous status of the Reader operations.

When power is applied, the Reader transmits a sign-on ID message. About 150 milliseconds after DTR is applied, the Reader sends the part number of the firmware in the following form: 21088819A01 <CR>. The first 8 characters indicate the firmware number; the letter is the revision, which is followed by a revision sublevel of 01 to 99. The <CR> indicates carriage return (0x0D). The sign-on messages for part numbers are listed in Section 3. Timing is also shown in Section 3.

Since the input voltage is supplied by a relatively low source of power, the Reader depends on its input capacitor to maintain proper charge during all operations. In order to reduce the drain on this internal power source during data transmission, the output data is transmitted in 5 to 6 millisecond bursts with a 10-millisecond gap between bursts to allow the capacitor to recharge. The PC software should be able to tolerate this 10-millisecond space between characters. The Timing is shown in Section 3, Figure 3-1. Configurations, including part numbers, firmware, tracks, and unit configuration, are listed in Section 3, Table 3-2.

MAG-TEK DEVICE DRIVERS FOR WINDOWS

The Mag-Tek Device Drivers for Windows, Part Number 30037385, may be used with the Port Powered Swipe Reader. When this program is used, refer to *Mag-Tek Device Driver for Windows, Programming Reference Manual*, Part Number 99875125.

FEATURES

Major features of the Swipe Reader are as follows:

- Powered through the RS-232 serial port – no external power supply required
- Hardware Compatible with PC or any computer or terminal with an RS-232 interface
- Software Compatible with Procomm, or any RS-232 communications program
- Bidirectional card reading
- Reads encoded data that meets ANSI/ISO/CDL/AAMVA standards
- Green LED for status

CONFIGURATION

The Reader, LED Indicator, pin numbers for the 9-pin connector, and the Adapter are shown in Figure 1-2.

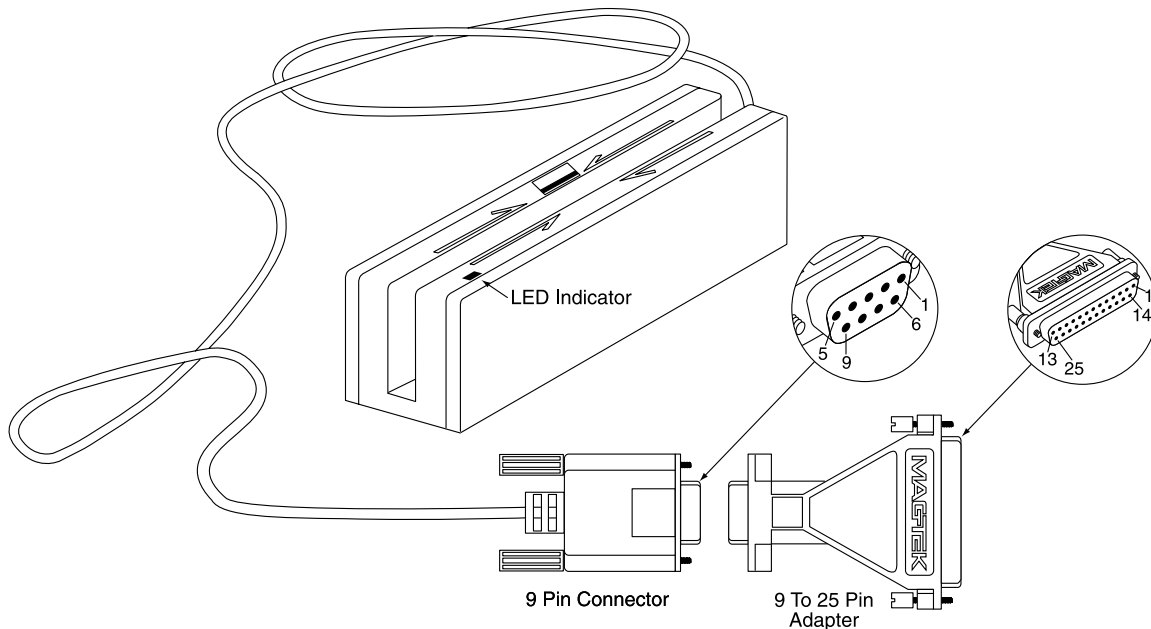

Figure 1-2. Reader Cable and Optional Adapter

Pin numbers and signal descriptions for the 9-pin (DE9) cable and 25-pin (DB25) adapter shown in the illustration are listed in Table 1-1. Also listed is the pin list OEM version, P/N 21040077.

Table 1-1. OEM and 9-Pin Connectors and 25-Pin Adapter

Connector for OEM Version 21040077 J2 on the PCB	25-pin Adapter	DE9-pin Connector	Signal
	-	1	NC*
1	3	2	RXD (to PC)
2	2	3	TXD** (from PC)
3	20	4	DTR (from PC)
4	7	5	GND
	-	6-9	NC*

* No Connection

** Pin must be connected to TXD (or DTR if TXD not available).

SPECIFICATIONS

Table 1-2 lists the specifications for the Port Powered Swipe Reader. Figure 1-3 shows the dimensions for the standard product. Other sizes are available by special order.

Table 1-2. Specifications

OPERATING	
Reference Standards	ISO/ANSI/ CDL/ AAMVA*
Power Input	From RS-232 interface
Recording Method	Two-frequency coherent phase (F2F)
Message Format	ASCII
Card Speed	3 to 50 IPS
MTBF	Electronics: 125,000 hours. Head: 1,000,000 passes
ELECTRICAL	
DTR Voltage	5 to 15 VDC
Current	
Quiescent	1 to 2 mA typical (continuous)
Transmitting	8 to 9 mA typical (5 ms duration)
Peak at Power On	12 mA
RS-232 Communication	9600 bps, no parity, 8 data bits, 1 stop bit
MECHANICAL (STANDARD PRODUCT)	
Dimensions	Length: 3.94" (100.0 mm), Width: 1.28" (32.5 mm) Height: 1.23" (31.3 mm)
Weight	Reader 5.8 oz. (165 gr.)
Cable length	5 Ft. (1.5 m)
Connector	9 pin D female (May require a 25-pin adapter)
ENVIRONMENTAL	
Temperature	
Operating	32°F to 131°F (0°C to 55°C)
Storage	-22°F to 158°F (-30°C to 70°C)
Humidity	
Operating	10% to 90% noncondensing
Storage	Up to 100% noncondensing
Altitude	
Operating	0-10,000 ft. (0-3048 m.)
Storage	0-50,000 ft. (0-15240 m.)

* ISO (International Standards Organization), ANSI (American National Standards Institute), CDL (California Drivers License), and AAMVA (American Association of Motor Vehicle Administrators).

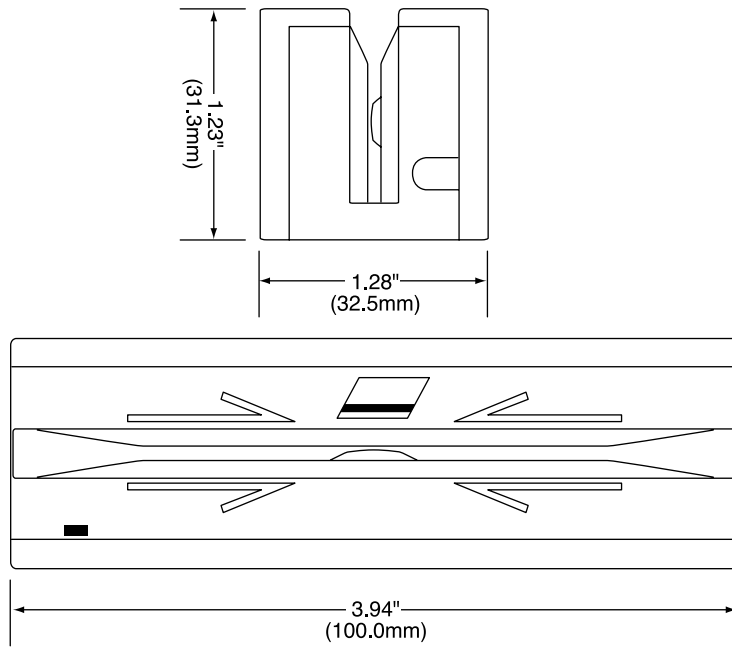

Figure 1-3. Dimensions

SECTION 2. INSTALLATION

The hardware installation consists of plugging the cable into the PC and optional adapter, if required, Com Port setup, and testing the Reader.

REQUIREMENTS

- Port Powered Swipe Reader
- Optional 9- to 25-pin Adapter, P/N 78200018
- PC with Com Port
- Procomm, Hyper Terminal, Mag-Tek Windows Drivers, or other RS-232 communications program

MOUNTING

1. The Reader can be mounted on a surface in three ways:
 - By two screws through the surface attached to the bottom of the unit and running the cable on the top of the surface;
 - By two screws through the surface attached to the bottom of the unit and by drilling a hole in the surface for the cable and running the cable through the hole;
 - By attaching the unit to the surface with fastening tape and running the cable on the top of the surface.

Note

The two mounting inserts are 3 mm diameter; 0.5 mm pitch; 6.4 mm deep. The length of the screws used depends on the mounting surface thickness and the thickness of washers (if used).

The mounting dimensions are shown in Figure 2-1. Determine the method of mounting required.

2. Ensure the Reader is positioned on a flat, accessible surface with at least 4 inches clearance on either end for room to swipe a card. Orient the Reader so the side with the LED is facing the direction of intended use.

If fastening tape is to be used, clean the area that the Reader will be mounted on with isopropyl alcohol. Remove the adhesive protective cover on the fastening tape, and position the Reader and push down firmly.

Port Powered Swipe Reader

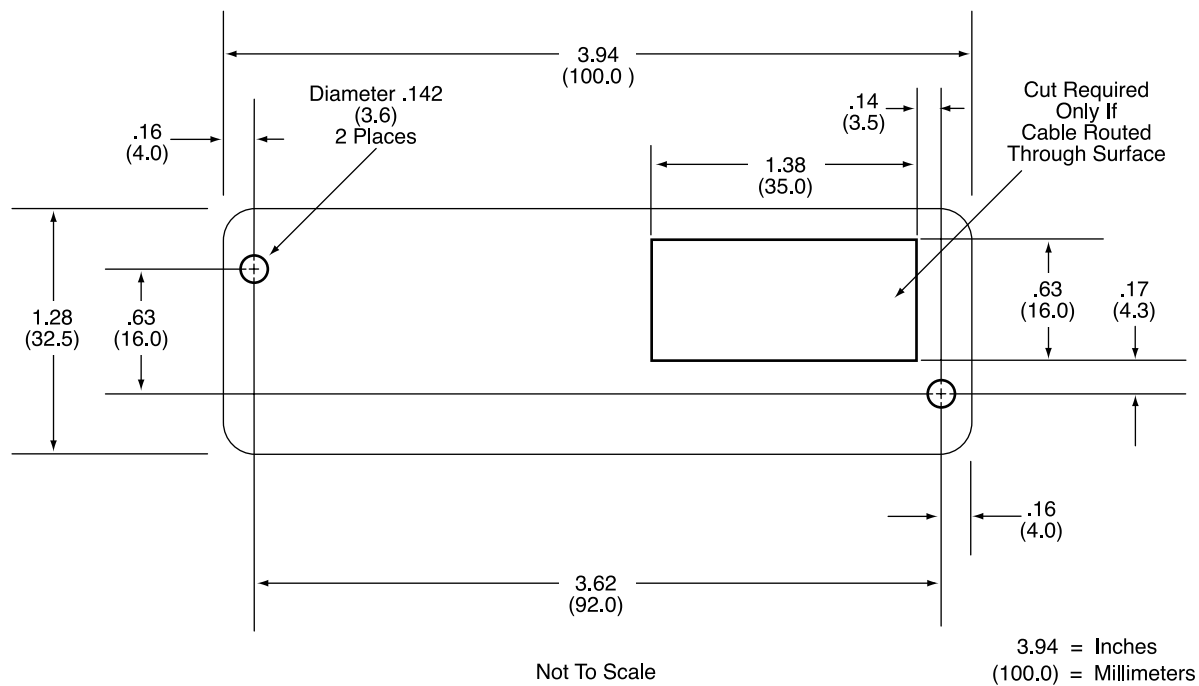

Figure 2-1. Mounting Hole Dimensions For Surface

3. Mount the Reader.

INSTALLATION AND TEST

To install the Swipe Reader, perform the following steps:

1. Connect the Swipe Reader cable connector into a 9-pin serial Com Port on the PC. If a 25-pin Adapter is required, plug the 9-pin connector on the Reader into the Adapter, and the adapter into the PC.
2. Open a communications program such as the Mag-Tek Encoder/Reader Demonstration Program, which may be obtained from the Internet at www.magtek.com. Navigate to the Demo Programs and select Reader & Encoder Demos (Win 95/98/NT).
3. On the program, select the Com Port the Reader is connected to.
4. If the Com Port selected is correct, the green LED on the Reader will light; if the *wrong* Com Port is selected, the LED will not light.
5. Select the baud rate of 9600.

6. Select 8 data bits, no parity, 1 stop bit.
7. With the LED on, swipe a card. The data on the screen will show Track 1 beginning with “%” and ending with “?”. Track 2 begins with “;” and ends with “?”. Track 3 begins with “+” (normal) or “!” (CDL) and ends with “?”. The following is an example:

%B123^Smith/Joann^9812101000?;1122223333334444444444?<0x0D>

If a track cannot be read, an **E** will appear in place of the track data; for example, if Track 2 is bad and Tracks 1 and 3 are good, the display will be similar to the following:

%11111111111111111111?;E?+33333333333333333333?<0x0D>

If Tracks 1 and 3 are bad and Track 2 is good, the display will be similar to the following:

%E?;22222222222222222222?+E?<0x0D>

8. If the data on the screen is not numeric or alphanumeric similar to the above, check the communications rate. If the alphanumeric characters are similar to the above, the unit is ready for operation.

SECTION 3. OPERATION

Included in this section are Indicator, Card Read, Reader to Host Message Format, and a timing diagram of sign-on ID.

LED INDICATOR

A green LED indicator on the panel gives the operator the status of the Reader. If the cabling is correct and the correct Com Port is selected, the indicator will be on. If the indicator does not come on, check the cabling and the Com Port. The LED is turned off during a card swipe and while the unit is transmitting.

CARD READ

A card may be swiped through the Reader slot when the green LED is lit. The magnetic stripe must face toward the front (the side with the LED) and may be swiped in either direction.

READER TO HOST MESSAGE FORMAT

Track data is sent in the following order: SS, Card Data, ES.

The format in which data is transmitted (in track order) after a card is read successfully is as follows:

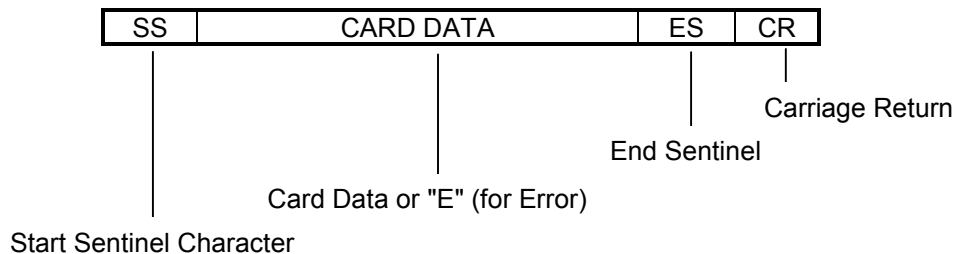

Table 3-1 lists Start Sentinel and End Sentinel symbols.

Table 3-1. SS and ES Track Symbols

Start Sentinel	End Sentinel	Description
%	?	Track 1
;	?	Track 2
+	?	Track 3 - ISO
#	?	Track 3 - AAMVA
!	?	Track 3 - CDL

TIMING FOR ID SIGN ON

Timing for the ID Sign-on and transmission bursts (5 ms with 10 ms between bursts) are shown in Figure 3-1.

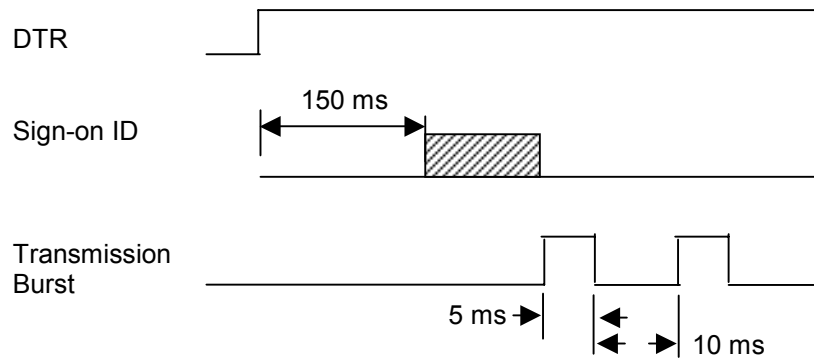

Figure 3-1. Timing For ID Sign-on and Transmission Bursts.

The firmware controls the operation of Sign-on ID and Transmission bursts in the following format:

210888xxLnn <CR>

Where:

the first 8 digits are the firmware part number (xx represents the Swipe Reader series),

L is the alpha revision,

nn is the number sub-revision.

<CR> is 0x0D.

Table 3-2 lists the available part number, firmware, and configuration.

Table 3-2. Sign-on ID for Configurations

Part Number	Firmware	Track Configuration	Configuration*
21040071	21088811	1,2	Pearl White
21040073	21088812	2,3	Pearl White
21040074	21088817	1,2,3	Pearl White
21040075	21088814	2	Pearl White
21040077	21088817	1,2,3	Black, No Cover, No Cable
21040079	21088811	1,2	Black
21040080	21088814	2	Black
21040081	21088811	1,2	Black (150 mm)
21040082	21088817	1,2,3	Black
21040084	21088811	1,2	Pearl White (with STX and ETX)
21040086	21088817	1,2,3	Pearl White, No Cover, 12" Cable, 6-pin
21040088	21088824	1,2,3	Pearl White, 4800/70, 10' cable
21040089	21088811	1,2	Pearl White, 10' cable
21040091	21088811	1,2	Black, No Cover, 5.9" Cable, 4-pin
21040092	21088817	1,2,3	Pearl White, 5 m cable
21040094	21068811	1,2	Pearl White, No Cover
21040096	21088811	1,2	Black, 4" Cable, 4-pin

*All cables are 6' DE9 unless otherwise specified.

MAGTEK DEVICE DRIVERS FOR WINDOWS PROGRAMMING REFERENCE MANUAL

Manual Part Number: 99875125 Rev 6

NOVEMBER 2001

MAGTEK

20725 South Annalee Avenue
Carson, CA 90746
Phone: (310) 631-8602
FAX: (310) 631-3956
Technical Support: (888) 624-8350
www.MagTek.com

Information in this document is subject to change without notice. No part of this document may be reproduced or transmitted in any form or by any means, electronic or mechanical, for any purpose, without the express written permission of Mag-Tek, Inc.

MagTek is a registered trademark of Mag-Tek, Inc.
Microsoft, MS, MSDOS, MSCOMM and Microsoft Visual Basic are registered trademarks of Microsoft Corporation; Windows and Windows 95 are trademarks of Microsoft Corporation.

REVISIONS

Rev Number	Date	Notes
1	20 Nov 98	Initial Release
2	16 Feb 99	Sec 1: Editorial comments for clarification; Sec 2: Added c_wr_secure and trks 1, 2, and 3; Sec 3: Editorial comments for clarification; Appendix A: Added MT-85 and clarified tables; Appendix D: Added c_wr_secure and tks 1, 2, and 3 and MT-85 Encoder sheet.
3	27 Apr 99	Global: Changed names of Mt-211 and MT-215 to port powered readers; Sec 3: Added card insertion note to event; Sec 4: Added this section, Data Parsing. Appendix A: Changed file names. Appendix D. Changed names.
4	21 Oct 99	Sec 1: added: part numbers of media, special commands, MICR material; Sec 2: changed properties table; Sec 3: added errors 45 and 60 to write command; Sec 4: added descriptions to language format; updated default formats; Sec 5: replaced Visual Basic example; Appendix A; Completely revised; Appendix D: added applied_fmt to all forms.
5	14 Dec 99	Appendix A: Added statement about "Long File Names" under "Adding MagTek Device Drivers" General Notes number 4; added statement to "Completing the Installation" about sharing a single port; Edited "Removing the Drivers"; added "Configuration Examples of NT Drivers." Appendix D: Under IntelliPIN PINPad and MSR, added statement under Remarks about IntelliPIN driver; under MiniWedge MSR added statement about ASCII and Character Conversion.
6	30 Nov 01	Editorial changes throughout and added Software Version MTD 1.10, which includes Windows ME/2000/XP.

Limited Warranty

Mag-Tek, Inc. (hereinafter "Mag-Tek") warrants this Mag-Tek product IN ITS ENTIRETY, to be in good working order for a period of 90 days from the date of purchase from Mag-Tek. Should this product fail to be in good working order at any time during this warranty period, Mag-Tek will, at its option, repair or replace this product at no additional charge except as set forth below. Repair parts and replacement products will be furnished on an exchange basis and will be either reconditioned or new. All replaced parts and products become the property of Mag-Tek. This limited warranty does not include service to repair damage to the product resulting from accident, disaster, misuse, abuse, or non-Mag-Tek modification of the product.

Limited Warranty service may be obtained by delivering the product during the warranty period to Mag-Tek (20725 S. Annalee Ave., Carson, CA 90746). If this product is delivered by mail, you agree to insure the product or assume the risk of loss or damage in transit, to prepay shipping charges to the warranty service location and to use the original shipping container or equivalent.

ALL EXPRESS AND IMPLIED WARRANTIES FOR THIS PRODUCT, INCLUDING THE WARRANTIES OF MERCHANTABILITY AND FITNESS FOR A PARTICULAR PURPOSE, ARE LIMITED IN DURATION TO A PERIOD OF 90 DAYS FROM THE DATE OF PURCHASE, AND NO WARRANTIES, WHETHER EXPRESS OR IMPLIED, WILL APPLY AFTER THIS PERIOD, EXCEPT AS PROVIDED IN THE PRECEDING SENTENCE. EACH PURCHASER UNDERSTANDS THAT THE MAG-TEK PRODUCT IS OFFERED AS IS.

IF THIS PRODUCT IS NOT IN GOOD WORKING ORDER AS WARRANTED ABOVE, YOUR SOLE REMEDY SHALL BE REPAIR OR REPLACEMENT AS PROVIDED ABOVE. IN NO EVENT WILL MAG-TEK BE LIABLE TO YOU FOR ANY DAMAGES, INCLUDING ANY LOST PROFITS, LOST SAVINGS OR OTHER INCIDENTAL OR CONSEQUENTIAL DAMAGES ARISING OUT OF THE USE OF OR INABILITY TO USE SUCH PRODUCT, EVEN IF MAG-TEK HAS BEEN ADVISED OF THE POSSIBILITY OF SUCH DAMAGES, OR FOR ANY CLAIM BY ANY OTHER PARTY.

THIS WARRANTY GIVES YOU SPECIFIC LEGAL RIGHTS, AND YOU MAY ALSO HAVE OTHER RIGHTS WHICH VARY FROM STATE TO STATE.

TABLE OF CONTENTS

SECTION 1. OVERVIEW	77
PROBLEMS WITH CONTROLLING DEVICES	77
BENEFITS OF A CONTROL LANGUAGE AND DRIVER	78
LANGUAGE OVERVIEW	79
Properties.....	79
COMMANDS	80
TYPICAL OPERATION	81
Open a device	81
Query the device's capabilities	81
Prepare the device for work	81
Use the device	81
Close the device	82
METHODS OF ACCESSING THE DEVICE	82
Obtaining access to the device	82
Interacting with the device	83
Releasing access to the device	84
ERRORS AND ERROR PROCESSING	84
HANDLING SPECIAL COMMANDS	85
FILE PROPERTIES	85
INSTALLATION.....	86
MICR Format Numbers.....	86
SECTION 2. PROPERTIES	87
account_no	87
amount	87
applied_fmt	87
c_card_stat	87
c_keypress	87
c_keystring	87
c_magnetic.....	87
c_mechanics	87
c_pin.....	87
c_smart	87
c_tracks.....	87
c_write.....	88
c_wr_secure.....	88
capitalize	88
card_stat	88
chk_account.....	88
chk_amount	88
chk_bankid.....	88
chk_data	88
chk_format	88
chk_mod10	88
chk_number	88
chk_routing	88
chk_status.....	88
chk_transit.....	88
cmd_pending	88
dblpinentry	88
dev_status.....	88
dev_version.....	88
enable_cmc7.....	88

enc_key.....	89
enc_key_sn.....	89
enc_mode.....	89
entry_echo.....	89
entry_len.....	89
entry_tout.....	89
events_on.....	89
invalcmdrsp.....	89
key_parity.....	89
lasterr.....	89
max_pin_len.....	89
msg1 - msg4.....	89
oper_tout.....	90
pin_blk_fmt.....	90
pinfilldig.....	90
port_name.....	90
pwroffdelay.....	90
s_down_tout.....	90
track1ss.....	90
trivpinchk.....	90
trk_enable.....	90
trk1data.....	90
trk2data.....	90
trk3data.....	90
visa_mac1.....	90
visa_mac2.....	90
visa_mac3.....	90
wr_coer.....	90
wr_secure.....	90
xact_type.....	90
SECTION 3. COMMANDS.....	91
DATA FORMAT.....	91
RESPONSES.....	91
Notation Conventions.....	92
COMMAND DESCRIPTIONS.....	92
cancel.....	92
display.....	93
echo.....	93
event.....	94
get.....	94
load_key.....	95
rawrecv.....	96
rawsend.....	97
rawxact.....	97
read.....	98
Read Arguments.....	99
reset.....	102
set.....	102
ver.....	102
write.....	103
SECTION 4. MAGNETIC CARD DATA PARSING.....	105
GOALS.....	105
ASSUMPTIONS.....	105

DESCRIPTION.....	106
LANGUAGE FORMAT	107
Format Name	107
Format Template.....	107
Format Rules	107
DEFAULT FORMATS	111
EXAMPLE	112
Retrieving properties from a magnetic card.....	112
SECTION 5. EXAMPLE APPLICATIONS	115
PROGRAMMING HINTS	115
VISUAL BASIC EXAMPLE.....	115
C++ EXAMPLE	121
POWER BUILDER EXAMPLE.....	126
APPENDIX A. INSTALLATION AND SETUP	129
INSTALLING DEVICE DRIVERS (W95/98/ME)	130
Adding the First Device Driver (W95/98/ME).....	131
Adding Another Device Driver (W95/98/ME).....	131
Updating an Installed Device Driver (W95/98/ME).....	132
Completing the Installation (W95/98/ME).....	132
Modifying A Device Driver's Settings (W95/98/ME).....	133
Removing The Drivers (W95/98/ME).....	135
INSTALLING DEVICE DRIVERS (WNT).....	137
Installing the Driver Binaries (WNT)	138
Uninstalling the Drivers (WNT)	138
INSTALLING DEVICE DRIVERS (W2000/XP).....	139
Installing the Driver Binaries (W2000/XP)	140
Uninstalling the Drivers (W2000/XP)	141
Uninstalling the Keyboard Hook Driver – (W2000/XP).....	141
WINDOWS NT/W2000/XP CONFIGURATION UTILITY	142
Adding a Keyboard Device (WNT/2000/XP).....	142
Adding a Serial Device (WNT/W2000/XP).....	143
Adding an 'IntelliPIN MICR Aux' Device (WNT/W2000/XP).....	143
Viewing the List of Configured Devices (WNT/W2000/XP).....	144
Using the MTCFG Utility (WNT/W2000/XP).....	144
Command syntax summary	145
Displaying Configuration Information (WNT/W2000/XP).....	145
Adding New Devices (WNT/W2000/XP).....	145
Configuration Examples of NT/W2000/XP	147
Modifying a Device Driver's Settings (WNT/W2000/XP)	148
Removing a Device (WNT/W2000/XP).....	149
APPENDIX B. COMMAND LIST SUMMARY	151
APPENDIX C. STATUS CODES	153
APPENDIX D. DEVICE DRIVER SUMMARIES	155
INTELLIPIN PINPAD & MSR	156
MAGWEDGE SWIPE READER.....	157
MINIWEDGE MSR	158
MICR+ CHECK READER & MSR.....	159
MINI MICR CHECK READER & MSR	160
PORT-POWERED RS-232 SWIPE READER	161
PORT-POWERED RS-232 INSERTION READER	162
MT-85 LOCO ENCODER.....	163

MT-95 HICO ENCODER.....	164
INDEX.....	165

FIGURES

Figure 1-1. MagTek Devices and Device Drivers for Windows.....	76
Figure A-1. Properties Settings, Windows 95	134
Figure A-2. Advanced Settings, Windows 95.....	134

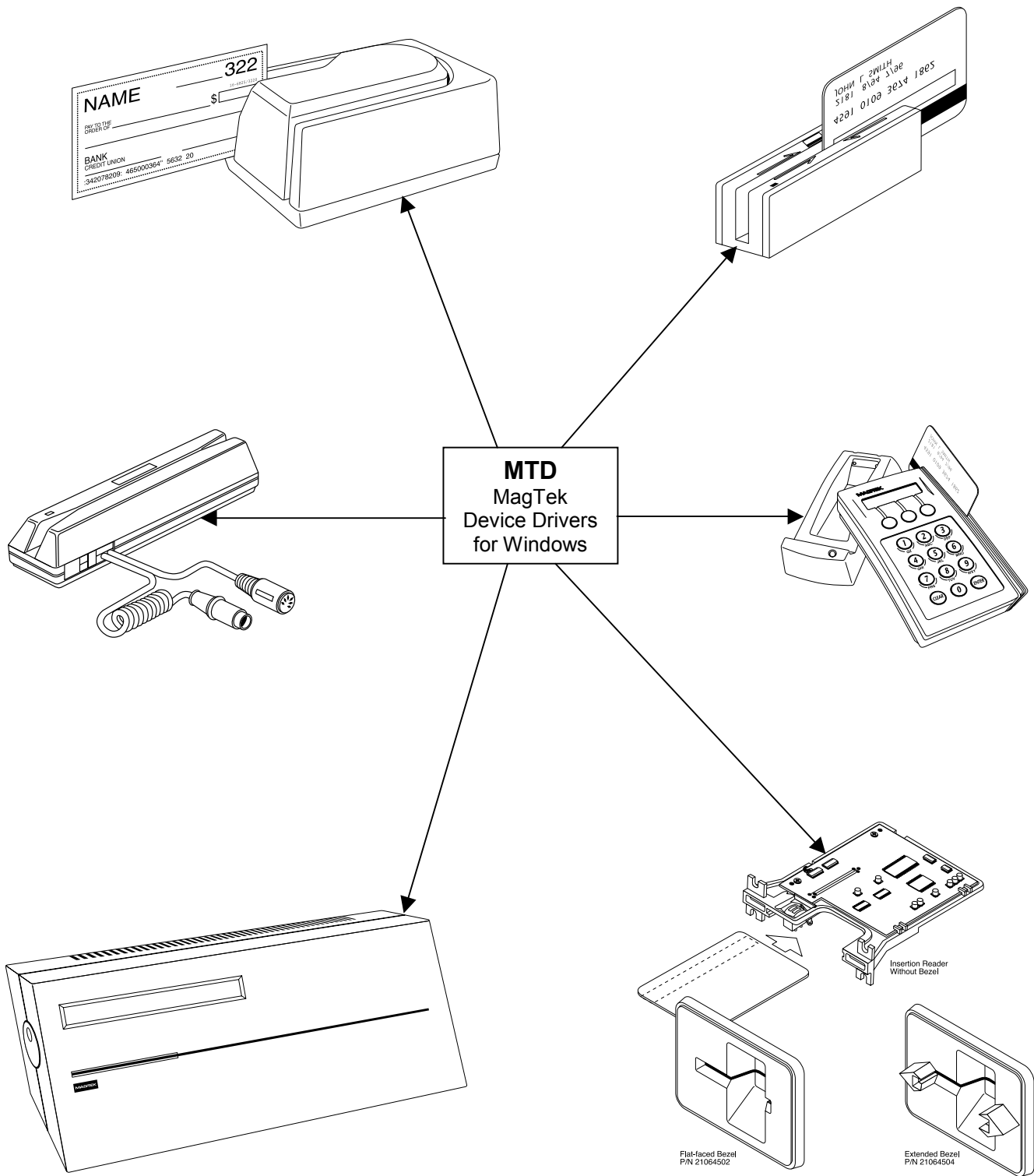

Figure 1-1. MagTek Devices and Device Drivers for Windows

SECTION 1. OVERVIEW

The MagTek Device (MTD) Drivers for Windows is a collection of individual drivers that support a number of MagTek products. These drivers provide a uniform application interface for controlling a wide range of MagTek devices. The drivers, combined with a device control language, solve many of the difficulties application developers face when attempting to control hardware devices. The difficulties mount when faced with the task of developing an application that supports an entire product line of devices.

Part Numbers for the MTD are as follows:

Part Number	Windows Version	Medium
30037385	All	CD
99510030	9X/ME	Internet* (MTD110-9x-ME)
99510031	NT	(MTD110-NT)
99510032	2000/XP	(MTD110-2K-XP)

*www.magtek.com

PROBLEMS WITH CONTROLLING DEVICES

The major problems with developing an application that supports an entire product line of devices are as follows:

- ***Each MagTek device has a unique set of commands.*** The commands usually perform similar functions on a particular class of devices but either differ in syntax or have small variations in their functionality. An application would have to implement a custom mechanism to control each device it supported—much like DOS applications had to do to support various printers.
- ***Most MagTek devices communicate via data streams, not packets.*** This means that an application receives data from the device one character at a time; it only receives partial command responses. It would be the application's responsibility to collect the incoming data and parse it into individual responses.
- ***Responses from MagTek devices are inherently asynchronous.*** When an application sends a command that requires a response, the response from the device arrives (or worse, begins to arrive) long after the command is sent. The application would have to either poll the device until all of the response is collected or implement a callback mechanism to collect and receive it.
- ***Most MagTek devices maintain a communication protocol of some kind.*** In addition to this, the protocols differ between devices. For example, some devices frame responses with STX and ETX control characters and others simply use a CR or require a checksum in the frame. To deal with this, an application would have to recognize and implement all of the various protocols for the devices it supports.

- ***MagTek devices are attached to the host in different ways.*** MagTek devices may be attached to a serial port, parallel port, to another device or even to the keyboard port. All these ports differ greatly in nature and would all have to be accessed by the application. Additionally, meaningful communication with a device attached to the keyboard port would be tricky at best. This is because the operating system does not provide a means to send data to the keyboard port nor any mechanism to discriminate between the device data and manual keystrokes.

BENEFITS OF A CONTROL LANGUAGE AND DRIVER

A device control language is defined to support most of the functionality of all MagTek devices. As noted previously, most devices of a particular class have similar functionality. The control language defines a common set of commands that perform these functions in the same way for all MagTek devices, thus eliminating device-specific coding for most applications. If the need arises to perform an operation on a device not covered by the common command set, a “raw” send and receive command can be used to communicate directly with the device, effectively eliminating any limitations on the amount of control you have over the device.

The control language is based on a simple property/command model. This model is familiar to most developers who deal with properties and methods in development environments such as Visual Basic or Delphi. You set up the device by getting and setting properties and operate it by invoking commands.

The command set presents a synchronous interface to the application even though the device operates asynchronously, greatly simplifying the effort in retrieving responses from a device. The pattern is simple: send a command to the device and invoke a read command, which will not complete until after the entire response is received from the device.

The control language is implemented by a driver, which completes the solution for the application developer. The driver adds the following benefits:

- ***Gives easy access to the device.*** All MagTek devices are presented uniformly as a virtual serial port, regardless of how they are actually attached to the host.
- ***Hides the communication protocol.*** Adding and stripping frames, performing checksums, detecting and correcting communication errors, etc, are handled completely by the driver. The application sees only the data that it is interested in and can be assured that it is free from transport errors.
- ***Converts the incoming data stream into complete responses.*** The application receives data from the device in easy to use packets. The entire response to a command is received in a single operation.
- ***Makes it easier to upgrade to a new device.*** The driver shields you from differences in the new device’s commands or interface. When upgrading the device, an application can

usually remain unchanged, even though the new device may be very different from the old one.

The features of a driver that implement a device control language completely shield an application developer from the complexities of device-specific functionality.

LANGUAGE OVERVIEW

The device control language is text based and designed to utilize the read and write file I/O facilities of the underlying operating system. All commands, their responses and properties consist of text strings that are written to or read from the driver using basic file I/O. The control language is based on a property/command model that is similar to the notions of properties and methods as accepted in environments such as Visual Basic or Delphi.

Properties

All properties are accessed in a uniform way: by using a **get** (`/get prop`) or **set** (`/set prop`) command. Properties are either read/write or read only. A **set** command with a read only property will fail. All properties are identified by a string name and use strings for their arguments. Properties defined by the control language fall into the following three groups:

- **Capability properties** – These properties contain information about the capabilities of a particular device and are generally read only. They allow an application to query a device’s capabilities to determine if the device is suitable for a particular task. Included in this category are `c_cardwpin`, `c_check`, `c_pin`, and `c_magnetic` (e. g., `/get c_check`).
- **Configuration properties** – These properties configure a device for different modes of operation or may alter the way some commands behave. Because of this, they are usually readable and writable. They give an application the ability to set up a device for a particular task that requires a specific, non-default mode of operation. Included in this category are `capitalize`, `dev_version`, and `port_name` (e.g., `/set capitalize 1`).
- **Device-specific properties** – These properties cover configuration requirements that are not common among MagTek devices, even if the devices belong to the same class. An application can determine if a particular set of device-specific properties is available by first querying the device’s capabilities or version. Refer to Appendix D, Device Driver Summaries, for a particular driver to see how these properties are affected with an individual device.

Properties can be “action” properties. That is, the driver may execute an action on the device when a property is set. For example, an application can enable or disable magnetic stripe tracks by setting the `trk_enable` property. The driver responds by sending one or more commands to the device to enable or disable the desired tracks.

COMMANDS

Like properties, commands are identified by a string name and have string arguments. All commands are terminated by line feed <LF> or a carriage return. To invoke a command, an application simply writes it to the driver in the same manner as writing to a file or serial port. If the command has a response defined for it, the application reads it from the driver using the same I/O handle as in the write.

Four types of commands are defined by the device control language:

- ***Non-interactive*** – These commands manipulate the device without requiring any interaction with the user. The property commands **get** and **set**, **reset** and **ver** are examples of this type.
- ***Interactive*** – These commands interact with the user. They do not necessarily require the user to do anything but may only prompt the user to do something. **display** is an example of such a command. Others, such as **read** or **write**, however, require user interaction to complete. For example, the user must either swipe a card or cancel the operation in order to complete a read command.
- ***Device-specific*** – These commands give access to device-specific features. For example, the **load_key** command is available for MagTek devices that use keys to encrypt data before sending it to the host.
- ***Raw*** – These are effectively escape commands. They allow the application to bypass the driver to perform device-specific operations that are not included in the driver syntax and not supported elsewhere. With these commands, an application has no limitations on the amount of control it has over a device. The raw commands can be formatted exactly as specified in the device documentation. The command bracketing will be inserted by the driver if required (e.g., <stx> and <etx> will be inserted for certain devices). Three commands are defined for this type: **rawsend** and **rawrecv**, used to send and receive data directly to the device, and **rawxact**, a transactional version that is a combination of the first two.

A small set of interactive and non-interactive commands is all that is required for an application to perform the most common tasks with these devices. Device-specific or raw commands should rarely ever be needed.

TYPICAL OPERATION

This section describes a typical pattern that an application developer may use to operate a device. Although it is the most typical pattern, it is by no means the only viable one. Refer to Section 5, Example Applications, to see how to use the drivers in various applications.

Open a device

Access to the device is obtained by opening the **comxx**: port that the device was installed as. This is not the hardware port that the device may be attached to, but a *virtual comxx* : port presented by the driver (e.g., COM5 or higher). A handle is returned by the *open* function and is required for all subsequent interactions with the driver. When opened, the driver initializes itself and, where required, the device.

Some drivers support automatic settings. In this mode, the driver first attempts to communicate with the device at the previous setting or at the default setting if it is the first time. (The setting for the initial attempt is grayed out in the manual settings fields.) If the driver does not receive a response, it will adjust the settings and try again. This sequence continues until the device responds or until all possible settings have been attempted.

If the driver is set for the automatic mode, it may take considerably longer for the device driver to detect an error. In particular, if the device is not connected to the specified port or if its power is off, the device driver may take several seconds attempting all possible settings before it returns an error. The application program should be tolerant of this delay.

Query the device's capabilities

The application now queries the device to determine if it can perform the required task. The capability properties (**c_xxx**) are provided for this purpose. For example, if an application requires the ability to read checks, it can **get** the **c_check** property to determine if the device can read checks.

Prepare the device for work

The device is prepared for operation by setting one or more of the configuration properties. Its mode of operation and other features are set up by these properties. Setting the **capitalize** property to **1** to cause all data written to or read from a card's magnetic strip to be capitalized is an example of this type of initialization. In some cases, modifying a property may cause the driver to execute functions on the device.

Use the device

The device is now fully initialized ready for operation. Because most tasks with the device require interaction with the user, the application operates the device using primarily the interactive commands. A typical scenario is when, in response to some event, the user is prompted to swipe a card by using the **display** command, followed by a **read** command to

instruct the device to return the card data when swiped. All the facilities of the driver are utilized during this stage of operation.

Close the device

When the application is finished with the device, it simply closes the port using the handle obtained when it opened it. The driver shuts down the device if required.

Note

In some cases with Windows 95, the Driver may not be closed properly. This will leave the port open and will prevent further communications with that device until the computer is rebooted.

METHODS OF ACCESSING THE DEVICE

This section describes how to use control language commands in a Visual Basic development environment using the MSComm (Microsoft Communication) component.

Obtaining access to the device

If the MSComm (Microsoft Communication) ActiveX component is used to access the device, set the **CommPort** property to the com port *number* of the device. Then, set the **PortOpen** property to **True** to open it. The following example shows how:

```
'set error handling
On Error Resume Next

'open the port
Comm.CommPort = 5
Comm.PortOpen = True
If Err.Number <> 0 Then
    <<process error>>
End If
on error goto 0
```

Note

After issuing an Open command, the computer may spend several seconds attempting to communicate with the device. During this time the computer will appear to be hung up.

If file I/O access is desired, you have the option of using either the device's friendly name, such as `\\.\micr+` (where `\\.\` specifies to Windows that this is a device and not a file) or its port name, `COM<5..15>`. The friendly name is more intuitive and easier to remember than a port number; however, the serial method gives the programmer better control of the device. The port number can be found in the operating system's device UI. For example, open Control Panel/System/Device Manager/MagTek and select a specific driver. Under Properties, select the

Settings tab. This gives both the Friendly Name and the port name (COM<5-15>). It also identifies the physical port that will be used to communicate with the device.

Open the device using either of the previous names. Use whatever facility is provided by your development environment for opening files. For Visual Basic, do the following:

```
'set error handling
On Error Resume Next

'open the port for binary access
Open "\\.\micr+" For Binary Access Read Write As #1
If Err.Number <> 0 Then
  <<process error>>
End If
on error goto 0
```

Note

The friendly name of the device, as found in the operating system's device UI (Device Manager in Windows 95, for example), must be prefixed with "\\.\\" in order to open the device. If the previous example did not have the prefix, it would create a file named micr+ in the current directory—clearly not the desired result.

Interacting with the device

An application interacts with the device by sending commands to the device and reading its responses. Commands are sent by writing to the opened port and responses from the device or property requests are retrieved by reading from the port.

To interact with the device using the MSComm component, invoke a command by assigning it to MSComm's **Output** property. The response is received by MSComm's **OnComm** event handler as a **comEvReceive** event or by directly polling the port. The entire response to a command or property request is received as a single event.

```
'submit echo command
Comm.Output = "/echo Hello" + Chr$(10)

Private Sub Comm_OnComm()
  'return if not a receive event
  If Comm.CommEvent = comEvReceive Then
    'process received data
    a$ = Comm.Input    'get echo data
  Else
    <<process non-read event>>
  End If
End Sub
```

If using file I/O access, interaction with the device is indistinguishable from writing to or reading from a file.

```
'set up error handling
On Error Resume Next

'submit echo command
Put #1, , "/echo Hello" + Chr$(10)

'declare an input buffer
a$ = String(2000, Chr$(0))

'read echo response from device
Get #1, , a$
If Err.Number <> 0 Then
    <<process error>>
End If
```

Note

File I/O interaction with the device is synchronous; the read operation will block until a response is received from the device or is returned by the driver (as in a property request). This means that a read command cannot be canceled because the computer will not accept any new commands while one is pending. The only exception to this is when the development environment provides access to the Win32 API, giving the application the ability to use overlapped file I/O.

Releasing access to the device

Releasing access to the device is very simple. If using MSComm, close the device by setting its **PortOpen** property to **False**:

```
'close the port
mscomm1.PortOpen = FALSE
```

If opened as a file, close it as in the following:

```
'close the port
Close #1
```

ERRORS AND ERROR PROCESSING

A command's execution status is returned to an application in the command's response, if it has one. The status value is a two digit numeric field located at positions 23 and 24 of the response (refer to Appendix C. Status Codes for a description of all error conditions) .

Errors are processed differently for property manipulation. If an error occurs while getting a property, the response will be returned with an empty property value. No status is returned when setting a property because the **set** command has no response defined for it.

If a command returns a non-zero status, indicating an error, an application can typically respond in the following manner:

1. It can prompt the user to repeat the action and re-submit the command. This is typical if the status does not indicate a failure, per se, but that the device may not be ready yet or first needs some other interaction by the user.
2. It can reset the device and prompt the user to repeat the action. Typically, this action is necessary if the device's state or configuration has been corrupted, but is otherwise functioning correctly.
3. Finally, the application can refuse to continue operation of the device. An application should do this only if the returned status indicates that the device is malfunctioning.

HANDLING SPECIAL COMMANDS

Some devices such as the IntelliPIN PLUS support a set of commands that are not standard and/or do not follow the usual protocol. The *Generic Driver* can be used to support these commands. It does not know how to communicate with any device and does not support any protocol. The *Generic Driver* allows the application to send any string to a device. When the *Generic Driver* is used, the application must form the command, insert packet characters, and compute a check character where required.

In particular, the IntelliPIN PLUS supports a set of commands that require <SI> and <SO> as command brackets instead of the usual <stx> and <etx> characters. These special commands cannot be used with the IntelliPIN PLUS drivers. If the <SI>/<SO> commands are required in an application, the *Generic Driver* can be used to formulate the commands and recognize the responses.

For example, in order to select one of the Multi-Master keys in the IntelliPIN PLUS, the format of the command is:

```
<SI>08 [address] <SO>{LRC}
```

The IntelliPIN PLUS driver cannot generate this command since all commands supported by the driver begin with <stx> and end with <etx>. To solve the problem, open the *Generic Driver* and send the following command to select master key number 3:

```
/rawsend \x0F083\x0E\x35
```

where <SI> is 0x0F and <SO> is 0x0E.

The *Generic Driver* can be used whenever a deviation from the standard protocol is required or when no protocol exists at all. However, the *Generic Driver* does not support any properties like all of the other drivers. It is only available to support those cases that cannot be handled with the standard drivers.

FILE PROPERTIES

When updating the MagTek Device Drivers, discussing performance characteristics, or reporting errors, it will be important to identify the part number and version of the associated file(s). In order to determine which version is installed, use Windows Explorer and go to the \Windows\System directory. Right click on the associated "VXD" driver file (see Appendix A.

Installation And Setup) and select *Properties*. Click on the *Version* tab. Note the *File Version*, *Part Number*, and *Description*.

INSTALLATION

The drivers are installed by means of the Windows "Add New Hardware" facility in Windows 95/98/ME and the "INF" installation feature in Windows NT/2000/XP. Refer to "Appendix A. Installation And Setup" for a full description of the installation procedure.

MICR Format Numbers

In order to retrieve the built-in check properties (chk_***), the driver automatically configures the MICR units to format number 6500. However, there are some cases, especially outside the United States, where the check information is not consistent with format number 6500. In these cases, the installer has the option of modifying the format number string in the OEMSETUP.INF file.

The format number can be changed to another value (e.g., 7700 to allow use of a flex format) by editing the field following the format number entry (%CheckFormatCodeName%) in the OEMSETUP.INF file. This must be changed in three places depending on which drivers are to be used (MICR+, MiniMICR RS232, and MiniMICR Wedge). By defining a flex format that would duplicate the 6500 output format, the driver will still be able to parse the check data and present the individual properties (e.g., chk_account, chk_amount, chk_number, and chk_transit). If a suitable format cannot be developed to present the individual properties, the driver will still be able to present the check data (chk_data) as received from the MICR reader. If the existing format number in the MICR device is suitable, set the %CheckFormatCodeName% entry to null (i.e., ""), so it will not be modified by the Driver.

Refer to the appropriate MICR Technical Reference Manual for more information about the use of format numbers and available MICR fields.

SECTION 2. PROPERTIES

This section lists the properties that are used in the MagTek Drivers. Properties can be interrogated by issuing a **get** command and modified with a **set** command. Refer to Section 3. Commands for complete description and examples of all commands.

The **c_xxx** properties are set by the driver and reflect the device's **capabilities**. However, the **c_xxx** properties **do not** indicate the configuration of the device. For example, a device may be capable of reading all three magnetic tracks but be configured to only read two tracks or a MICR reader, while often configured with a magnetic stripe reader, may not have an MSR installed. Unless otherwise noted, **1** means the capability is available, **0** or **null** (i.e., the value is not present) means that the capability is not available.

In this table, the *Access* information indicates whether the property can be modified (Read/Write–R/W) or merely accessed (Read Only–R).

Property	Access	Description
account_no	R/W	Cardholder account number, including check digit. It is set by the application to be used in PIN encryption commands (IntelliPIN).
amount	R/W	Transaction amount in cents, without punctuation (IntelliPIN).
applied_fmt	R	Indicates which format template was used to parse the magnetics data. If no template or rule is applied, this property returns a null.
c_card_stat	R	1 indicates that the driver supports retrieval of card sensor status (e.g., PPINSERT)
c_cardwpin	R	1 if the device supports reading of a card and a PIN in response to a single command (e.g., IntelliPIN).
c_check	R	1 if the device can read checks (e.g., MICR devices).
c_events	R	1 indicates that the driver supports unsolicited event notification (e.g., PPINSERT).
c_keypress	R	1 if the device supports retrieval of a key press (e.g., IntelliPIN).
c_keystring	R	1 if the device supports retrieval of a sequence of key presses (e.g., IntelliPIN).
c_magnetic	R	1 if the device can read magnetic cards.
c_mechanics	R	This value indicates how the card reader's mechanism operates: 0 – manually operated device or no card reader 1 – device is mechanized and supports “eject” 2 – device is mechanized and supports “eject” and “confiscate”
c_pin	R	1 if the device supports reading of PINs (e.g., IntelliPIN).
c_smart	R	1 if the device supports smart cards.
c_tracks	R	A three-character string, representing the tracks supported by the device. The left-most position indicates track 1. Thus 110 indicates that the device can access tracks 1 and 2 but not track 3. See trk_enable to determine which tracks are enabled.

Property	Access	Description
<code>c_write</code>	R	1 if the device can encode a magnetic card in either LoCo or HiCo; 2 if the device can encode a magnetic card in only the setting indicated in <code>wr_coer</code>
<code>c_wr_secure</code>	R	0 if the device does not support secure mode; 1 if the device can switch between secure and non-secure mode (see <code>wr_secure</code>); 2 if the device only operates in the secure mode.
<code>capitalize</code>	R/W	Set this to 0 to prevent the driver from capitalizing the data for the <code>read</code> and <code>write</code> commands. The default value for this property is 1 (enable capitalization).
<code>card_stat</code>	R	Current card sensor status: 0 = not blocked, 1 = blocked (PPINSERT).
<code>chk_account</code>	R	Check account number from check (MICR).
<code>chk_amount</code>	R	Check amount from check (MICR).
<code>chk_bankid</code>	R	Bank ID number from the transit field (MICR).
<code>chk_data</code>	R	Output data string as received from MICR reader (MICR).
<code>chk_format</code>	R/W	Indicates the format of the check data. Set to 6500 by default. If this property is modified by the application, the <code>chk_xx</code> properties (except <code>chk_data</code> and <code>chk_status</code>) will be set to null. (MICR)
<code>chk_mod10</code>	R	Mod10 check digit from the transit field (MICR).
<code>chk_number</code>	R	Check number (MICR).
<code>chk_routing</code>	R	Routing number from the transit field (MICR).
<code>chk_status</code>	R	2-digit status code from the check just read (MICR).
<code>chk_transit</code>	R	Transit number from check (MICR).
<code>cmd_pending</code>	R	Command pending—indicates which command, if any, is pending. If none is pending, the second argument will be null: <code>/get cmd_pending<LF></code>
<code>dblpinentry</code>	R/W	Set to 1 to enable double PIN entry such as when requesting a new PIN; set to 0 when verifying a customer's PIN (IntelliPIN).
<code>dev_status</code>	R	Device status. 0 means device is connected and operational. Any other value indicates a device-specific error. If the device fails to respond, a null value is reported: <code>/get dev_status<LF></code>
<code>dev_version</code>	R	Device version string. This value is read directly from the device, if the device supports a version string. <CR> characters in the string read from the device will be replaced with /. This property will be useful in reporting operational problems to MagTek.
<code>enable_cmc7</code>	R/W	Set this property to 1 to enable CMC-7 characters decoding, 0 to disable it. This is used for international checks; see MICR manual for more information. (MICR)

Property	Access	Description
enc_key	R/W	Encryption key to use for the next encryption process (IntelliPIN): M for Master key S for Session key 0-3 for lower working keys A-J for upper working keys
enc_key_sn	R/W	Serial number of encryption key. Used to specify key serial number for activating/deactivating PIN encryption in MSK mode and to return the key serial number in DUKPT mode. The key serial number is specified in clear text (IntelliPIN).
enc_mode	R/W	Current encryption mode – msk or dukpt (IntelliPIN).
entry_echo	R/W	Specifies how to display the characters when entered from the keypad on the LCD screen (IntelliPIN): <ul style="list-style-type: none"> • empty value to display as entered • (minus) to suppress display • \$ to display as amount The value of this property affects the operation of the read key_string command. By default this property is empty.
entry_len	R/W	Maximum number of characters (1-32) to be collected with the read key_string command. An empty value (default) for this property converts to a length of 1. (IntelliPIN)
entry_tout	R/W	Entry timeout: number of seconds (15-255) to wait for keypad input. (IntelliPIN)
events_on	R/W	Set to 1 to enable unsolicited event notifications. The default is 0 . (PPINSERT)
invalcmdrsp	R/W	Invalid command response: set to 1 to enable responses to invalid commands (useful during program development). This is set to 0 (disabled) by default.
key_parity	R/W	Set to 1 to enable parity check on encryption keys. (IntelliPIN)
lasterr	R	Status from the last command sent to the driver. A successfully executed command will reset this value to 0 . This property is useful for checking the operation of the set commands. After each set , the response to get lasterr should be 0 .
max_pin_len	R/W	Maximum PIN length (IntelliPIN): <ul style="list-style-type: none"> • 1 – 16 for ibm format (IBM 3624) • 4 – 12 for ansi format (ANSI 9.8)
msg1 - msg4	R/W	Messages to show on LCD screen with various commands. msg1 – used by the read and display commands msg2 – used by the display and read pin commands msg3 – used by the read pin command msg4 – used by the key_press and key_string operations To specify leading spaces, use \x20 . See the display command for more information. (IntelliPIN)

Property	Access	Description
offline_enc	R/W	Set to 1 to enable encode capability in standalone mode with keyboard; 0 prevents standalone encoding (MT-95).
oper_tout	R/W	Operational timeout in seconds (15-255). (IntelliPIN)
pin_blk_fmt	R/W	PIN block format (IntelliPIN): ansi (ANSI 9.8) or ibm (IBM 3624)
pinfilldig	R/W	PIN fill digit (0..9, A..F) when pin_blk_fmt is ibm (IntelliPIN)
port_name	R	Indicates the virtual port number (e.g., COM6) derived from the friendly port name.
pwroffdelay	R/W	Power off time delay in minutes (5-255). (IntelliPIN)
s_down_tout	R/W	Shutdown timeout in hours (1-31). Set to 0 to disable. (IntelliPIN)
track1ss	R	Indicates Start Sentinel on Track 1 as received from the device.
track2ss	R	Indicates Start Sentinel on Track 2 as received from the device.
track3ss	R	Indicates Start Sentinel on Track 3 as received from the device.
trivpinchk	R/W	Set to 1 for trivial PIN check i.e., don't allow 1234. (IntelliPIN)
trk_enable	R/W	Enable reading and writing of individual tracks. The value of this property is a string of three characters, with 0 representing disabled tracks and 1 representing enabled tracks, e.g., 110 enables tracks 1 and 2 and disables track 3.
trk1data	R	Data from track 1 excluding start sentinel and end sentinel.
trk2data	R	Data from track 2 excluding start sentinel and end sentinel.
trk3data	R	Data from track 3 excluding start sentinel and end sentinel.
visa_mac1 visa_mac2 visa_mac3	R	Message authentication codes returned by device after PIN is collected (DUKPT mode only). (IntelliPIN)
wr_coer	R/W	Encode Coercivity Mode (MT-95). Specifies the energy level used to encode the magnetic stripe: 0 = automatic selection 1 = LoCo only mode 2 = HiCo only mode
wr_secure	R/W	0 indicates the card can be removed between a read and write operation. Set this to 1 to turn on secure online encode mode (MT-95).
xact_type	R/W	Transaction type – d = debit, c = credit (IntelliPIN).

SECTION 3. COMMANDS

This section describes all of the commands that can be used with the MagTek Windows Device Drivers. Some commands require parameters to indicate to the driver exactly what function is to be performed. While there are a few device-specific commands, most commands can be used with any device.

DATA FORMAT

All commands sent to the driver and all responses received are strings of printable ASCII characters delimited by `<LF>`. The driver will also accept `<CR>` as a delimiter. All command and response strings begin with the character `/`. If a command has arguments, they should be separated with one or more white spaces. The driver accepts space `<SP>` and `<TAB>` as white space characters.

Note

A command delimiter sent immediately after the previous command delimiter is interpreted as an empty command and is ignored by the driver.

RESPONSES

All responses to the transaction commands are formatted with fixed fields, to allow them to be parsed either by scanning for white spaces or by using constant offsets into the response string. In the descriptions of the commands found later in this section, the arguments sent with the responses are shown in their respective locations but may not indicate the exact number of spaces. The actual responses are sent in a fixed-field format, as shown in the following table:

Field	Offset	Size	Comment
command name	0 (0-11)	12	This field identifies the command that produced this response, e.g., <code>/get</code> is followed by 8 spaces to fill the 12 locations.
arg1	12 (12-23)	12	Fixed-size argument – value depends on the command sent. A property name is left justified in the field and begins in location 12. Status information is right justified in the field (with a trailing space) so the SS value will always be located at positions 21 and 22.
arg2	24 (24-??)	var	Variable size argument – used for responses with variable-size data, like <code>/get prop</code> or <code>read status data</code> .

Examples:

```
000000000011111111112222222222
012345678901234567890123456789
/read          -00082
/get          trk_enable 110
```

NOTATION CONVENTIONS

The following conventions are used in the tables that follow.

- Fixed Size (Bold)** Used to represent literals (symbols, exactly as sent or received from driver)
- Italic* Used to represent placeholders (variable fields)
- [] Expression parts in brackets are optional. The brackets are never a part of the syntax
- <LF> ASCII control character. The only ASCII control characters used are <LF> (0x0A) and <CR> (0x0D).
- (a|b) Means that the expression can be either a or b, e.g., X(1|2) means either X1 or X2. The parentheses and the | are never part of the syntax.

COMMAND DESCRIPTIONS

The following list of commands includes function, syntax, errors, remarks, and examples as applicable.

cancel

- Function** Cancel a command.
- Syntax** /cancel [*cmd*]
The optional *cmd* can be any of the transaction commands such as:
 - /cancel rawrcv
 - /cancel rawxact
 - /cancel read
 - /cancel write
- Errors** If *cmd* is omitted, any pending commands will be canceled. If the specified command is not active, the command is ignored and there is no response.
- Remarks** The command being canceled will send a response immediately.
- Example** If a **read** command has been issued but the operation is to be aborted:
 - Command** /cancel read<LF>
 - Response** /read -00082<LF>

display

Function	Show a single message or two alternating messages on the device's display.
Syntax	<code>/display [x]</code> The optional argument <i>x</i> indicates the message to be displayed.
Errors	<i>none</i>
Remarks	<p>If the optional argument <i>x</i> is provided, this command displays it as a single message. If <i>x</i> is <code>@</code>, the driver sends a command to the device to display the idle message <code>00</code> ("Welcome"). If <i>x</i> is omitted, the command uses the values of the <code>msg1</code> and <code>msg2</code> properties for the message texts. If <code>msg2</code> is empty, this command displays the text in <code>msg1</code>; otherwise, it displays the texts in <code>msg1</code> and <code>msg2</code> as alternating messages. The message texts are displayed unmodified, except for any <code>\</code> characters, which are used as escape characters:</p> <ul style="list-style-type: none"> <code>\r</code> is converted to 0x0D (shown as <code><CR></code> in this document) <code>\n</code> is converted to 0x0A (shown as <code><LF></code> in this document), e.g., to be used as line separator for LCD screens that can display multiple lines <code>\\</code> is converted to <code>\</code> <code>\xhh</code> is converted to a character with ASCII value <i>hh</i> (always two hex digits). <p>Not all ASCII values can be displayed.</p> <p>Leading and trailing spaces are removed from the message texts in the <i>x</i> argument and the <code>msg1</code> and <code>msg2</code> properties. <code>\x20</code> may be used for adding leading spaces.</p> <p>To center the message "Thank You" on the IntelliPIN LCD:</p> <p>Command <code>/display \x20\x20\x20Thank You</code></p> <p>Response <i>none</i></p>

echo

Function	Echo data–driver test command.
Syntax	<code>/echo string</code> <i>string</i> is limited to 11 characters (the width of the 'arg1' field in the response format) without any embedded spaces.
Errors	<i>none</i>
Remarks	The driver responds by echoing the command back. If the command specifies a string that is longer than 11 characters or if a space appears, the response will be truncated. There is no translation for escape (<code>\x00</code>) commands. This command cannot be cancelled with <code>/cancel</code> .
Example	<p>If you wish to ensure that the driver is properly installed, request it to echo a string:</p> <p>Command <code>/echo Testing<LF></code></p> <p>Response <code>/echo Testing<LF></code></p>

event

Function	Response to an unsolicited event notification.
Syntax	<i>none</i>
Errors	<i>none</i>
Remarks	<p>This response can occur when an unsolicited event, such as card inserted, occurs. The format of the response is: <i>/event n data</i></p> <p><i>n</i> is a numeric event code:</p> <ul style="list-style-type: none">1 – medium has been inserted into the reader2 – medium has been removed from the reader <p><i>data</i> specifies the type of medium that was inserted/removed:</p> <ul style="list-style-type: none">M – magnetic <p>Events are sent to the application only if the <code>c_events</code> property is 1 (driver supports events) and the <code>events_on</code> property is set to 1 by the application. If a card has already been inserted when the driver is opened, there will not be any notification when <code>events_on</code> is enabled. Consequently, it is recommended that <code>/get card_stat</code> be issued immediately after opening the driver to see if a card is blocking the sensor.</p>
Example	<p>If you wish to be notified when a card has been inserted into the PPINSERT:</p> <p>Command <code>/set events_on 1<LF></code></p> <p>Response <code>/event 1 M<LF></code></p> <p>When a card is inserted into the slot.</p>

get

Function	Get a property.
Syntax	<code>/get prop</code> <i>prop</i> is one of the valid properties shown in Section 2 or any of those from data parsing.
Errors	<code>/get abc<LF></code> Since abc does not exist.
Remarks	<p>The driver sends a response in the format: <code>/get prop val</code>.</p> <p>If the requested property does not exist, the <i>val</i> field will be empty, i.e., <code><LF></code> follows the <i>prop</i> field. If the command was cancelled, both the <i>prop</i> and <i>val</i> fields will be empty. In some cases, this command will interrogate the device to determine the property setting. Some properties cannot be interrogated if a command (such as read) is pending. The value will be null in this case.</p>
Example	<p>If you wish to find out which tracks are enabled, request the <code>trk_enable</code> property:</p> <p>Command <code>/get trk_enable<LF></code></p> <p>Response <code>/get trk_enable 110<LF></code></p> <p>Indicating track 1 & 2 are enabled, track 3 is disabled.</p>

load_key

Function	Load an encryption key into the device.
Syntax	<pre>/load_key n key</pre> <p><i>n</i> can be one of the following values:</p> <ul style="list-style-type: none"> M – master key (<i>key</i> is in clear text) S – session key (<i>key</i> is encrypted under Master Key) 0 ... 3 – lower working keys (<i>key</i> is encrypted under Session Key) A ... J – upper working keys (<i>key</i> is encrypted under Session Key) <p><i>key</i> is the 16- or 32-character value of the key to be loaded.</p>
Errors	<pre>/load_key 30<LF></pre> <p>If the <i>n</i> field is invalid, <i>key</i> is the wrong length, or the device sends an error (e.g., there is a key parity error).</p> <pre>/load_key 45<LF></pre> <p>If the required key is not loaded.</p>
Remarks	This command is used to load a key into the device. With all but the master key, the selected key is encrypted under another key so the application must know the encrypted value of the key. The response to this command is: <code>/load_key SS</code> <i>SS</i> is a two digit status code; 00 – success, 30 – invalid, 45 – rejected, etc.
Example	To load the session key encrypted under the master key: <pre>Command /load_key S 99E1E835662DEA94<LF></pre> <pre>Response /load_key 00<LF></pre>

rawrecv

Function	Receive data from the device.								
Syntax	<code>/rawrecv</code>								
Errors	<table border="0"> <tr> <td style="padding-right: 20px;"><code>/rawrecv</code></td> <td><code>45<LF></code></td> </tr> <tr> <td></td> <td>If a command is already pending.</td> </tr> <tr> <td><code>/rawrecv</code></td> <td><code>82<LF></code></td> </tr> <tr> <td></td> <td>If the command was canceled by the user (e.g., with CLEAR key)</td> </tr> </table>	<code>/rawrecv</code>	<code>45<LF></code>		If a command is already pending.	<code>/rawrecv</code>	<code>82<LF></code>		If the command was canceled by the user (e.g., with CLEAR key)
<code>/rawrecv</code>	<code>45<LF></code>								
	If a command is already pending.								
<code>/rawrecv</code>	<code>82<LF></code>								
	If the command was canceled by the user (e.g., with CLEAR key)								
Remarks	<p>This command overrides the default processing of the next message that comes from the device and returns it to the application as a rawrecv response. Only one message from the device will be processed in this manner, after that the driver switches to normal operation. The response to this command is in the following format: <code>/rawrecv status x</code></p> <p><i>status</i> is a 2-digit decimal value (refer to Appendix C. Status Codes for a complete description of the status values)</p> <p><i>x</i> is the data received from the device with the following characters replaced:</p> <ul style="list-style-type: none"> • <code><CR></code> is replaced by <code>\r</code> • <code><LF></code> is replaced by <code>\n</code> • <code>\</code> is replaced by <code>\\</code> • any other non-printable characters are replaced by <code>\xhh</code>, where <i>hh</i> is the two digit hex code of the character. <p>If a <code>/rawsend</code> command is sent that will cause the device to send back a response, the application should either submit a <code>/rawrecv</code> command before sending the data with <code>/rawsend</code>, or (better) use the <code>/rawxact</code> command.</p>								

Note

In some cases, the framing characters in the response are extracted by the driver and are not presented to the application.

Example To receive card data when the IntelliPIN is operating in the VeriFone mode:

Command `/rawrecv<LF>`

Response `/rawrecv` `00 ;12345?<LF>`

rawsend

Function	Send arbitrary data to the device.
Syntax	<code>/rawsend x</code> <i>x</i> is an arbitrary string which is transmitted directly to the device. The string <i>x</i> is passed as-is to the device, except for ‘\’ which is used as an ‘escape’ character: <ul style="list-style-type: none"> • <code>\r</code> is converted to <code><CR></code> • <code>\n</code> is converted to <code><LF></code> • <code>\\</code> is converted to <code>\</code> • <code>\xhh</code> is converted to a character with ASCII value <i>hh</i> (always two hex digits), e.g., <code>\x20</code> is converted to a space.
Errors	<i>none</i>
Remarks	This command as with the other raw commands supports any features that have not been implemented in the standard set of commands. Note: the driver inserts appropriate framing characters, e.g., <code><stx></code> and <code><etx></code> .
Example	To change the default message 00 to show “Welcome to Our Bank” on two lines of the IntelliPIN: <pre> Command /rawsend 5100Welcome to\x1COur Bank<LF> Response none </pre>

rawxact

Function	Execute a send/receive transaction with the device in raw mode.
Syntax	<code>/rawxact x</code> <i>x</i> is an arbitrary string which is transmitted directly to the device. The string <i>x</i> is passed as-is to the device, except for ‘\’ which is used as an ‘escape’ character: <ul style="list-style-type: none"> • <code>\r</code> is converted to <code><CR></code> • <code>\n</code> is converted to <code><LF></code> • <code>\\</code> is converted to <code>\</code> • <code>\xhh</code> is converted to a character with ASCII value <i>hh</i> (always two hex digits), e.g., <code>\x20</code> is converted to a space.
Errors	<code>/rawxact 45<LF></code> If a command is already pending. <code>/rawxact 82<LF></code> If the command was canceled by the user (e.g., with CLEAR key)
Remarks	This command is a combination of <code>/rawsend</code> and <code>/rawrecv</code> . It sends the supplied data to the device, overrides the default processing of the next message that comes from the device and returns it to the application as a <code>/rawxact</code> response. After the response is returned (or canceled), the driver switches to normal operation. The syntax for this command is identical to the syntax of the <code>/rawsend</code> command; the syntax of the response is identical to the <code>/rawrecv</code> response.
Example	To load a master key of 23AB4589EF6701CD into the IntelliPIN: <pre> Command /rawxact 9423AB4589EF6701CD<LF> Response /rawxact 00 940<LF> </pre>

read

Function	Read data from the device.
Syntax	<code>/read [[x] y]</code> The optional argument <i>x</i> specifies the data source; if <i>x</i> is missing, a card will be read. Refer to the Read Argument table below for a description data sources. The optional argument <i>y</i> is used to specify a message to be displayed on the LCD screen, if supported, before carrying out the command. If <i>y</i> is omitted and the device supports a display, the text in the <code>msg1</code> property is shown. In order to use <i>y</i> , the <i>x</i> argument must be present. See the <code>display</code> command for the description of the message format for <i>y</i> .
Errors	<code>/read -00045<LF></code> If a command is already pending or the <code>enc_key</code> is not defined for <code>read pin</code> . <code>/read -00082<LF></code> If the command was canceled by the application (82) or by the user (83) (e.g., with CLEAR key).
Remarks	The response to this command has the following format: <code>/read status data</code> The <i>status</i> field is a 6-character string aligned to the right in the <i>arg1</i> field. It is formatted as follows: <code>TX₁X₂X₃SS</code> <i>T</i> defines the type of data that was read: C = a check was read M = a magnetic card was read P = a PIN was read K = a key press or string was read - = indeterminate: no data was received from the device. Returned on errors not specific to the data type, such as command canceled (SS=82). <i>X_i</i> define a media-specific status. For checks, this is the decimal representation of the check read status, as defined in the MICR specification. For magnetic cards, XXX indicates the read status for each of the three magnetic tracks (see <code>card</code> in the Read Arguments table below for a description of the status). For PIN data this status is always 000 ; for keypress and string data, <i>XXX</i> is the data length in characters. <i>SS</i> is a two-digit status code. 00 indicates a good read (but some tracks may be bad); any other status code indicates an error. These error codes indicate an error in the communication between the driver and the device or driver's internal errors. Read errors are reported in the <i>X_i</i> fields and do not cause the <i>SS</i> field to be set to a non-zero value. See Appendix C. Status Codes. The <i>data</i> format is described in the <code>write</code> command below.
Example	To request an amount to be entered by the customer on the IntelliPIN: Command <code>/set entry_len 6<LF></code> <code>/read key_string Enter the amount<LF></code> Response <code>/read K00300 123<LF></code>
Example	To read a card (from any device): Command <code>/read card<LF></code> Response <code>/read M10900 ;12345?<LF></code> track 1 error, track 2 good, track 3 blank

Read Arguments

The optional argument *x* used in the **read** command specifies the type of data to read and *y* specifies the text to be displayed. The following table describes the recognized *x* arguments for the **read** command:

Read Argument	Description
any	Read any type of data. This option is equivalent to read without any arguments.
card	Read magnetic stripe card. Display message (msg 1) if defined. When the user swipes a card, the response will be in the following format: <i>/read mX₁X₂X₃SS data</i> <i>X_i</i> define the track read status for each of the three tracks, as follows: 0 = good track 1 = bad track 9 = no track data. <i>SS</i> is a two-digit status code; it is not affected by errors reported in the <i>X_i</i> field: 00 – successful read 82 – canceled, etc. <i>data</i> is the card data for all successfully read tracks.
card_w_pin	Read magnetic stripe card and collect PIN from cardholder. Display messages if defined. This command is similar to the read card command except that after the card is swiped, the device collects and stores the cardholder's PIN. The PIN can be collected later by issuing the read pin command. Before issuing this command, the following properties may be set: msg1 , msg2 , msg3 – messages to be displayed while waiting for card swipe and PIN entry (a default message will be used if these properties contain empty strings). The response to this command is identical to the read card response; if successful, it returns the track data from the magnetic card. If the response status <i>SS</i> is 00 , the read pin command can be used to collect the PIN.
check	Read check data. When the user reads a check, the response will be in the following format: <i>/read cX₁X₂X₃SS data</i> <i>XXX</i> is the decimal representation of the check read status, as defined in the MICR specification, e.g., 004 indicates a bad character in the check number field. <i>SS</i> is a two-digit status code: 00 – successful read, 82 – canceled, etc. This status is not affected by errors reported in the <i>XXX</i> field. <i>data</i> is the check data, which is also available in chk_data . The data format depends on the setting of the chk_format property.

Read Argument	Description
chk_or_card	Read magnetic stripe card or check data. When a card or check is swiped through the device, the driver sends the respective response.
key_press	<p>Display a message (msg4) on the LCD screen, if available, and wait for a key on the keypad to be pressed. The device will wait for entry_tout seconds for the key press (by default 0 for no timeout). The response to this command is: /read KXXXSS K</p> <p><i>XXX</i> is the number of keys collected. Always 001 on successful read, 000 if failed.</p> <p><i>SS</i> is a two-digit status code: 00 – successful read, 81 – timeout, etc.</p> <p><i>K</i> is the ASCII representation of the pressed key (if <i>SS</i> is 00).</p>
key_string	<p>Display a message (msg4) on the LCD screen, if available, and collect a string of key presses (digits) from the device. The following properties affect this command:</p> <ul style="list-style-type: none"> • entry_tout – number of seconds to wait for input (by default 0 for no timeout) no timeout) • entry_echo – how to display the characters entered from the keypad on the LCD screen: empty value to display as entered, - (minus) to suppress display, \$ to display as amount. Empty by default. • entry_len – maximum number of characters to be collected. An empty value for this property is interpreted as a length of 1 by the device (default). <p>The response to this command is in the following format: /read KXXXSS data <i>XXX</i> is the data length in characters <i>SS</i> is a two digit status code: 00 – successful read 81 – timeout 83 – input aborted, etc. <i>data</i> is the string collected from the device.</p>

Read Argument	Description
pin	<p>Collect PIN from cardholder and read PIN data from the device.</p> <p>The following properties may be set before issuing this command:</p> <ul style="list-style-type: none"> • account_no – cardholder account number, including check digit, if required • amount – transaction amount in cents, without punctuation, if required • enc_key – (MSK mode only) encryption key to use: M for master, S for session, 0-3 for lower working keys, A-J for upper working keys. • xact_type – (DUKPT mode only) transaction type: D for debit, C for credit <p>The response will be: <code>/read P000SS pin_block</code></p> <p><i>SS</i> is a two-digit status code:</p> <ul style="list-style-type: none"> 00 – successful read 45 – enc_key is not defined 83 – aborted, etc. <p><i>pin_block</i> is the encrypted PIN block as returned by the device.</p> <p>Upon successful read, the following properties will be set:</p> <ul style="list-style-type: none"> • visa_mac1, visa_mac2, visa_mac3 – message authentication codes (DUKPT mode only) • enc_key_sn – serial number of encryption key (DUKPT mode only)

reset

Function Reset the device.
Syntax `/reset`
Errors *none*
Remarks Clear any pending operations and reset the device to initial state (for mechanized card devices this command will also eject the card). This does not affect any of the properties.
Example To return a device to its initial state:
Command `/reset<LF>`
Response *none*

set

Function Set a property.
Syntax `/set prop val`
prop is one of the valid properties (R/W) shown in Section 2. Properties *val* represents the value of that property.
Errors *none*
Remarks This command is used to define each of the properties that are required prior to sending a command.
Example To load the key serial number in the IntelliPIN:
Command `/set enc_key_sn 0123456789012345<LF>`
Response *none*

ver

Function Read driver version.
Syntax `/ver`
Errors *none*
Remarks The response to this command is sent in the following format: `/ver num text`
num is the driver's part number
text is a free format version string. It may contain a tagged-format data enclosed in parentheses, as shown in this example
This **is not** the version of the device.
Example To determine the version of the currently active driver:
Command `/ver<LF>`
Response `/ver 30037395 Mag-Tek Device Driver
(Version=1.04 Model=IntelliPIN) <LF>`

write

Function	Data encode command.
Syntax	<code>/write data</code>
Errors	<p><code>/write</code> 94 <LF> Encode is not supported on this device.</p> <p><code>/write</code> 34 <LF> The <i>data</i> field was in the incorrect format.</p> <p><code>/write</code> 82 <LF> The write command was canceled.</p> <p><code>/write</code> 45 <LF> Device in wrong mode (e.g., if /read already issued)</p> <p><code>/write</code> 60 <LF> Error during write operation (e.g., on MT-95)</p>
Remarks	<p>The <i>data</i> field is in the following format: [<i>%an-data?</i>][<i>;</i><i>n-data?</i>][<i>@a-data?</i>][<i>(+n-data?</i>][<i>#an-data?</i>][<i>!an-data?</i>][<i>&an-data)</i>] <i>an-data</i> is alphanumeric data (ASCII characters ‘ ‘ to ‘ ’ (0x20 to 0x7f)) <i>n-data</i> is numeric data (ASCII characters ‘0’ to ‘?’ (0x30 to 0x3f))</p> <p>The data should not contain the end sentinel character (?).</p> <p>If the application sends data for an alphanumeric track that contains lowercase characters (ASCII values beyond 0x60), they will be capitalized if capitalize = 1. To disable this and send the data as-is to the device, set the capitalize property to 0. The three sub-sections of the data string represent the three tracks on the magnetic card. The data for each track begins with a start sentinel character, which defines both the track number and the data format for the track:</p> <ul style="list-style-type: none"> % identifies track 1 (7-bit alphanumeric) ; identifies track 2 (5-bit numeric) @ identifies track 2 (7-bit alphanumeric) + identifies track 3 (5-bit numeric) ! identifies track 3 (CA Driver License) # identifies track 3 (alphanumeric, AAMVA) & identifies track 3 (7-bit alphanumeric) <p>Note that any or all of the data may be missing, but the order of the data for the tracks must always be in order (1, 2, 3). A missing track is interpreted as “don’t write” for the data encode command – that track will not be overwritten by the encode operation.</p> <p>The response sent for this command is: <code>/write status</code>. <i>status</i> is 00 if the encode succeeded and non-zero if it failed.</p> <p>See the definitions of the status values in Appendix C. Status Codes.</p>
Example	<p>Encode tracks 1 and 2:</p> <p>Command <code>/write %B12345^TEST^0000?;12345?<LF></code></p> <p>Response <code>/write</code> 00 <LF></p>

SECTION 4. MAGNETIC CARD DATA PARSING

This section describes the flexible data parsing language to be used by the MagTek device drivers to parse specific fields from magnetic card data and expose those fields as properties which may be retrieved by an application using the `/get` command. The data parsing language is flexible in that it can define both standard and custom formats to be parsed by the driver.

GOALS

For most MagTek devices, the MTD drivers completely hide the device-specific commands and peculiarities, thereby allowing applications to use the same command set and logic for all devices.

Up to this point, the above mentioned encapsulation has not been applied to the data returned by the device when a magnetic card is swiped. It has been left to the application to interpret the card data. This can become troublesome because the track formats and or/data contained on each track vary depending on the type of card (e.g., ATM or Drivers License).

The goals for the flexible data parsing are:

- easy to specify formats
- allow parsing of standard formats
- allow extending formats with custom fields
- allow detection of format and applying different parsing
- allow for missing tracks and missing fields by setting the corresponding property to empty
- allow presets to be loaded from the registry
- to expose parsed fields to applications via the `/get` command
- allow MagTek or system integrators to define formats in the driver installation file (OEMSETUP.INF).

ASSUMPTIONS

- The driver validates the format template and rules for syntax, but it cannot validate the format string for correctness in relation to parsing the fields of data. For example, if the format string specifies that a field has a fixed size of 3 and it actually has a fixed size of 4, the driver will not detect this.
- There is no backward parsing (i.e., field identifiers come before the field). For example, if A identifies an account number, it cannot follow the account number (e.g., 12344556A). It must come before the account number (e.g., A12344556).
- Beginning and end sentinels are specified in the format string for magnetic data formats.
- The terminating separator that follows a variable length property field is included in the format string as a literal.
- There are no parsing interdependencies between fields of data and/or format rules.

- Property names specified in format rules are 11 characters or less, consisting of alphabetic characters, digits, and ‘_’. The property name begins with an alphabetic character.
- Properties used in format strings do not conflict with properties defined by the driver. If there is a duplicate property (e.g., `dev_version`) specified in the format strings, the driver will return the value of the parsed property rather than the device version string.
- Magnetic stripe formats are comprised of the following types of fields.

Format Code	– One or two characters specifying the format of the data to follow
Field Separator	– Used to delimit fields of data
Fixed-Size	– Data field which is fixed-length
Variable-Size	– Data field which is variable-length and is terminated by a field separator
Optional	– The data is either a fixed-size field or a field separator (if the field is not present)

DESCRIPTION

The MTD driver supports up to 8 different card formats. Each format consists of a name, a template, and a set of rules. There may be multiple rules for a single template, but there can only be one template per format name. The *name* identifies the format. The *template* provides a high-level format to which the data is to be compared so as to determine if the rules for the format in question should be applied. The *rules* are specific format strings that specify how to parse the data and the properties into which the parsed data is to be stored.

When the driver applies a format, it will make that knowledge available to an application through a property which can be retrieved with the `/get` command.

The driver may be parameterized with the formats via values in the device’s software key in the registry. The following REG_SZ registry values are supported where *x* is a number 1-8.

<code>fmtx_name</code>	name for format
<code>fmtx_template</code>	format template
<code>fmtx_rules</code>	one or more comma-delimited rules

When the driver receives data from the device, it attempts to match the incoming data to one of the templates. If a template matches, the driver attempts to parse the data using one of the rules corresponding to the matched template. It sequentially attempts to apply each rule in the order that it appears in the `fmtx_rules` property. If the driver cannot apply any of the rules, the driver attempts to match the data to the next template and apply its rules until it either successfully applies a rule or runs out of templates.

If the driver is successful in applying one of the rules, the name of the applied format is available in the property **applied_fmt**.

LANGUAGE FORMAT

Format Name

(fmtx_name)

The format name specifies an identifier by which to identify the format template and/or rules being applied. The maximum length of this property is 11 characters. The names can be repeated on subsequent templates.

Format Template

(fmtx_template)

The format template provides a high-level structure to which the incoming data must conform in order to apply the format's rules. It is formed by concatenating characters and asterisks contained in angle brackets (<>) or parenthesis. The *format template* string cannot exceed 63 characters. The following is an example:

%<*>?;59<*>?(!|#)<*>?

The above template specifies that if track 1 exists; the first two characters following the start sentinel of track 2 are "59"; and the start sentinel character for track 3 is either '!' or '#' then the rules for this template should be applied.

The <*> symbol specifies a don't-care situation. All data up to the character following the <*> in the template string is ignored when evaluating the data against the template. All other characters in the template string must be matched with the data.

Format Rules

(fmtx_rules)

The format rules property specifies one or more rules that describe how the data is to be parsed. It is a comma-separated string of rules where each rule has the following format:

{<rule>}

Because the '{' and '}' characters are used to delimit each rule and specify optional tracks, these characters cannot be specified as literals within the rule.

A format rule describes how the data is to be parsed. Characters that must be matched as literals are placed as is in the string or preceded with a ‘\’ if the character is one of the following: ‘[’, ‘]’, ‘(’, ‘)’, ‘*’, ‘_’, ‘<’, ‘>’, ‘:’, ‘.’, or ‘\’. Fields that are either to be parsed or ignored are contained within <>. The *format rules* string cannot exceed 1027 characters. The following is an example for retrieving the customer name and account number from track 1:

```
{%B<acct_no>^<cust_name>^<*>?}
```

The ‘%’ specifies the start sentinel and ‘B’ specifies a format ID for the track. These two characters must be matched for the remainder of the rule to be executed. <acct_no> specifies that all data up to the following ‘^’ should be stored in a property named “acct_no”. <cust_name> specifies that all data up to ‘^’ should be stored in a property named “cust_name”. <*> specifies that the remainder of the track data up to ‘?’ should be ignored.

The following table describes the procedure for specifying fields. Remember that property names can have a maximum of 11 characters.

Note

If there is a property specified more than once in a rule, the last successful match will be saved in the property. The driver will ignore previous matches and the value will not be compared to the previously saved value for consistency.

Field Type	Example	Description
Variable size field	<acct_no>	All data up to the next field separator or end sentinel is stored in a property named “acct_no”.
Fixed size field	<exp_date[n]>	Store the next <i>n</i> characters in a property named “exp_date”.
Variable size field with limit	<cust_name[x..y]>	Store at least <i>x</i> characters and at most <i>y</i> characters up to the next field separator or end sentinel into property named “cust_name”.
Variable size (ignore)	<*>	Ignore all characters up to the next character specified in the format string (usually a field separator) or the end sentinel character (?).
Fixed size (ignore)	<*[n]>	Ignore the next <i>n</i> bytes.
Variable size with limit (ignore)	<*[x..y]>	Ignore at least <i>x</i> characters and at most <i>y</i> characters up to the next literal found.

Field Type	Example	Description
Literal	^	A literal is placed in the string as is and is used to determine if a particular format should be applied and to mark the end of a variable-length field.
Non-ASCII literal	\r, \n, \\, \xhh	Specify an escape character or non-ASCII character. <ul style="list-style-type: none"> • \r is converted to <CR> • \n is converted to <LF> • \\ is converted to \ • \xhh is converted to a character with ASCII value hh (always two hex digits).
Optional choice	(x y ...)	The field specifies a choice where the data can be either a literal or a property field. There may be any number of literals specified but there may not be more than 1 property field, for example (= <country_code[3]>). If the character is a '=', skip it; otherwise store the next three characters into a property named "country_code".
Optional field	[x]	Specifies an optional sequence that may or may not be present in the data. x may be one or more literal fields, property fields, or optional choice fields.
Optional track	{xy}	The data parser will not enforce that the track be present in the data when attempting to match the data to the template or rule. x must be a literal field or an optional choice field containing a literal. y may be any sequence of fields except for another optional track field.

There can be more than one rule specified for a particular format template. The rules should be placed in a single string enclosed in curly braces (i.e., '{' and '}') and delimited with commas ','. When the driver applies rules for a particular template, it sequentially attempts to apply each rule in the order it is provided in the fmtx_rules string. For example: "{rule 1},{rule 2},{rule 3}" would cause the driver to first try to apply rule 1. If the incoming data did not match rule 1, the driver attempts to apply rule 2 followed by rule 3 if rule 2 fails. If no rules can be applied, the driver attempts to match the incoming data to the next template.

The property name can also contain a modifier at the end preceded by a ':' which specifies the type of data to store in that property. For example <cust_name:A> specifies that customer name should contain alphabetic characters, spaces, and punctuation. The modifier may also be used with ignore-fields (i.e., <*>). If no modifier is provided, any type of characters is assumed. The set of supported modifiers is described in the following table:

Modifier	Description
A	Alphabetic characters (A..Z a..z), space, and punctuation (. , : ') are allowed.
D	Numeric characters (0..9).
N	Alphanumeric characters. This is the union of A and D.
\xhh	\ xhh is converted to a character with ASCII value <i>hh</i> (always two hex digits). Only this character is allowed in the field. This modifier is only valid for "ignore" type fields.
*	Any character is allowed (default if no modifier supplied).

DEFAULT FORMATS

The MTD drivers will be assigned parameters with default formats for parsing magnetic stripe data. The formats will be placed in the INF file for the driver and written to the registry when the driver is installed. Some examples are shown below; more are included with the drivers. In these examples, spaces are inserted between fields for readability; they should not be included in the actual rules.

```

fmt1_name    "ISO59"
fmt1_template"%B<*>^<*>^<*>?;59<*>=<*>?"
fmt1_rules   "{%B<*>^<*[3]><LastName>/<FirstName>\x20<MidName>
              ^<*[7]><DiscData1>?
              ;<PAN[13..19]>=<*[3]><ExpDate[4]><SrvCode[3]><DiscData2>?},
              {%B<*>^<*[3]><LastName>/<FirstName>^<*[7]><DiscData1>?
              ;<PAN[13..19]>=<*[3]><ExpDate[4]><SrvCode[3]><DiscData2>?}"

fmt2_name    "BankCardA"
fmt2_template"%A<*>^<*>^<*>?;<*>=<*>?"
fmt2_rules   "{%A<LastName>/<FirstName>\x20<MidName>^<*>^<*[7]><DiscData1>?
              ;<PAN[13..19]>=<ExpDate[4]><SrvCode[3]><DiscData2>?},
              {%A<LastName>/<FirstName>^<*>^<*[7]><DiscData1>?
              ;<PAN[13..19]>=<ExpDate[4]><SrvCode[3]><DiscData2>?}"

fmt3_name    "BankCard"
fmt3_template"%B<*>^<*>^<*>?;<*>=<*>?"
fmt3_rules   "{%B<*>^<LastName>/<FirstName>\x20<MidName>.<Title>
              ^<*[7]><DiscData1>?
              ;<PAN[13..19]>=<ExpDate[4]><SrvCode[3]><DiscData2>?},
              {%B<*>^<LastName>/<FirstName>.<Title>^<*[7]><DiscData1>?
              ;<PAN[13..19]>=<ExpDate[4]><SrvCode[3]><DiscData2>?}"

fmt4_name    "CADL"
fmt4_template"% (C|S|D|I|R)<*>?;600646<*>?{(#|!)<*>?}"
fmt4_rules   "{%<*[1]><FirstName>\x20<MidName>\x20<LastName>[\x20]<*: \x20[0..57]>
              <Adr[29]><City[13]>?
              ;<*[6]><DLID[9]><*>=<ExpDate>=<DateOfBirth[8]>?
              {(#!)<*[8]><State[2]><ZIP[9]><Sex[1]><Hair[3]><Eye[3]><Hgt[3]><Wgt[3]>
              <*>?}"

```

```
fmt5_name      "AAMVA"
fmt5_template "%<*>?;<*>?{(+|%|#|!)<*>?}"
fmt5_rules     "{%<State[2]><City>^<LastName>$<FirstName>$<MidName>^<Adr>^<*>?
;<*[6]><DLID>=<ExpDate[4]><DateOfBirth[8]><*>?
{(!|#|%)<*[2]><ZIP[11]><*[16]><Sex[1]><Hgt[3]><Wgt[3]><Hair[3]>
<Eye[3]><*>?}},
{%<State[2]><City>^<LastName>$<FirstName>^<Adr>^<*>?
;<*[6]><DLID>=<ExpDate[4]><DateOfBirth[8]><*>?
{(!|#|%)<*[2]><ZIP[11]><*[16]><Sex[1]><Hgt[3]><Wgt[3]><Hair[3]>
<Eye[3]><*>?}}"
```

In the examples for CADL (California Drivers License) and AAMVA (all other drivers licenses), the braces around the rules for track 3 indicate that track 3 is optional.

EXAMPLE

Retrieving properties from a magnetic card

In this example, the rules above have been stored in the registry by the installation script.

The following data is received from the device:

```
%B1234567890074589^SMITH/JOHN Q.MR^9912101254700000000000123?
;1234567890074589=991210112547?
```

Format 1 (ISO59) would not be applied because the first two digits of track 2 are not 59. Format 2 (BankCardA) would not be applied since there is not an 'A' following the start sentinel. However, the data fits the template for format 2 (BankCard).

The following properties and their corresponding values will be exposed:

```
LastName      →    "SMITH"
FirstName     →    "JOHN"
MidName       →    "Q"
Title         →    "SMITH"
DiscData1     →    "2547000000000000123"
PAN           →    "1234567890074589"
ExpDate       →    "9912"
SrvCode       →    "101"
DiscData2     →    "12547"
```

The application receives the successful read response **/read M00900 <card data>**.

The application issues **/get applied_fmt**.
The driver responds with **/get applied_fmt BankCard**.
The application issues **/get FirstName** to the driver.
The driver responds with **/get FirstName JOHN**.

The application issues **/get LastName** to the driver.
The driver responds with **/get LastName SMITH**.

The application issues **/get PAN** to the driver.
The driver responds with **/get PAN 1234567890074589**.

The application issues **/get ExpDate** to the driver.
The driver responds with **/get ExpDate 9912**.

After all of the required properties have been retrieved, the application can place them in appropriate strings as required by the application.

SECTION 5. EXAMPLE APPLICATIONS

While each application in this section is oriented toward a specific programming language, different devices are addressed in each example. It may be useful for the reader to look at all examples to understand how the MagTek Windows Drivers can operate with various MagTek devices.

PROGRAMMING HINTS

When opening a Keyboard Wedge device, the application must wait for any key press to complete, e.g., **ALT-0**. The application should wait until all keys have been released.

VISUAL BASIC EXAMPLE

This program is a simple example of using the MagTek Windows device drivers in Visual Basic. It opens the device driver and waits for the user to click the read button. At that time, it arms the driver for the read operation and waits for a read to take place. When the check data (in the case of a MICR) is received, it displays the data and waits for the read button to be pressed again.

The user first presses the Start button to open the port. After that, the Read button is pressed to initiate a read. After the check is read, the Read button can be pressed again for another cycle. The Exit button can be pressed at any time to quit the program.

Option Explicit

```
'+-----+
'|      MTD Driver example      |
'+-----+
'| written in Visual Basic 5.0 |
'+-----+
'
' (c) Copyright Mag-Tek, Inc. 1999
' All rights reserved
'
' Mag-Tek Part Numbers:
' Source code - 30037336 REV 101
' PROG 3.5" - 30037335 REV 101
'
' Purpose: This program is a simple example of using the
' Mag-Tek Windows device drivers (MTD) in Visual Basic. It
' opens the device driver and waits for the user to click the
' read button. At that time, it arms the driver for the read
' operation and waits for a read to take place. When the
' check data (in the case of a MICR) is received, it displays
' the data and waits for the read button to be pressed again.
'
' The user first presses the Start button to open the port.
' After that, the Read button is pressed to initiate a read.
' After the check is read, the Read button can be pressed
' again for another cycle. The Exit button can be pressed
' at any time to quit the program.
```

```
' The form needs to contain:
' 1) an "MSComm" object named MSComm1

' 2) a button named btnStart, should be set to Enabled
' and Visible with the caption "Start"

' 3) a button named btnRead, should be set to Disabled
' and Visible with caption "Read"

' 4) a button named btnExit, should be set to Enabled
' and Visible with caption "Exit"

' 5) a text box named txtInfo, should be set to Visible, Enabled and
' MultiLine containing initial text of "Click the Start button to
' open the port"

' Note: Lines shown ending in an underscore are continuation line, i.e.
' its one BASIC statement, split over two or more lines.
' The underscore MUST be preceded by a space, otherwise BASIC
' will interpret it as part of the statement and generate an
' error.
```

```
' This is the global buffer we'll use to collect the data
Dim RcvdData$
```

```
'+-----+
'| btnExit_Click |
'+-----+-----+
'| Close the com port (if open) and exit the program |
'+-----+-----+
```

```
Private Sub btnExit_Click()
    If MSComm1.PortOpen Then
        MSComm1.PortOpen = False
    End If
    Unload Me
End Sub
```

```
'+-----+
'| btnRead_Click |
'+-----+-----+
'| This function does the following: |
'| 1) Disable the read button |
'| 2) Send the read command |
'| 3) Wait for the read response |
'| 4) Display the read data |
'| 5) Reenable the read button |
'+-----+-----+
```

```
Private Sub btnRead_Click()
    ' Disable the read button so we don't get two read
    ' commands pending
    btnRead.Enabled = False

    ' Clear the receive buffer
    RcvdData$ = ""

    ' Send the read command
```

```

MSComm1.Output = "/read card" & Chr$(10)

' If the device has check reading capability, then the
' following command would be used to read only the check
' data
' MSComm1.Output = "/read check" & Chr$(10)

' If the device can read only one media type (e.g. a
' card reader) then the read command "/read" command can
' be issued by itself.
' MSComm1.Output = "/read" & Chr$(10)

' If the device is capable of reading more than one
' media type and the application is capable of accepting
' data from any of the media, then the read command can
' be issued by itself or with the "any" parameter. (They
' are equivalent.)
' MSComm1.Output = "/read" & Chr$(10)
' or
' MSComm1.Output = "/read any" & Chr$(10)

' Ask the user to do the read
txtInfo.Text = "Please swipe a card or click on Exit to quit"

' Wait until the card is read.
' In real life, the program can do other things while
' waiting for the data
Do
  DoEvents
Loop Until Len(RcvdData$) > 0

' Display the received data
txtInfo.Text = RcvdData$

' Reenable the read button
btnRead.Enabled = True
End Sub

'+-----+
'| btnStart_Click |
'+-----+-----+
'| This function does the following: |
'| 1) Set up the buttons and display |
'| 2) Open the device under its "friendly name" as a file |
'| 3) Retrieve its "unfriendly name" (e.g. "COM12") |
'| 4) Extract the com port number from the unfriendly name |
'| 5) Close the device (IMPORTANT: this must be done or you will not |
'| be able to open the device again, in any mode, without |
'| resetting the computer) |
'| 6) Open the device under its "unfriendly name" as a serial device |
'+-----+-----+
Private Sub btnStart_Click()
' will hold the fully qualified name of the driver
Dim NewName$

' will be used to get data from the device driver
Dim buf$

```



```
' will hold the numeric port number
Dim PortNumber As Integer

' prevent the Start button from being pressed again
btnStart.Enabled = False

txtInfo.Text = "Please wait. Opening the port as File IO"
txtInfo.Refresh

' declare space for an input buffer
buf$ = String(2000, Chr$(0))

' If the virtual serial port number is unknown, it can be
' obtained by opening the driver in "File" mode with
' the "Friendly Name" and asking for the virtual COM port number.
'
' The sequence is:
' 1) Open the driver as a binary file
' 2) Request the "port_name" property
' 3) Close the driver
' 4) Open the serial port using the number obtained above
' 5) Send/receive commands/data
' 6) Close the serial port when done
'
' As of release 1.08.01 of the MTD drivers,
' the default Friendly Names are:
' -----
' "Mag-Wedge"
' "MT-85"
' "MT-95"
' "Port-powered swipe reader"
' "Port-powered insert reader"
' "MiniWedge"
' "MICR+"
' "Mini MICR RS-232"
' "Mini MICR Wedge"
' "IntelliPIN RS-232"
' "IntelliPIN Wedge"
' "IntelliPIN MICR Aux"
' "Generic Serial (RS-232)"
' "Generic Wedge (Keyboard)"
'
' Prepend "\\.\\" to the "friendly" name which
' tells Windows that this is a device name and not a file name
NewName$ = "\\.\\" + "MiniWedge"

' Trap the "file not found" error if the
' device is not present or ready
On Error Resume Next

' Try to open the device, this can take anywhere from one
' second to one minute
Open NewName For Binary Access Read Write As #1

' If the driver was unable to open the device, then
' inform the user
```

```

If Err.Number <> 0 Then
  ' Process error using Err.Description
  ' contains error description for the demo,
  ' we'll just display it
  txtInfo.Text = Err.Description

  ' Reset the error handling
  On Error GoTo 0

  ' exit this sub
  Exit Sub
End If

' reset the error handling
On Error GoTo 0

' send the command to get the port number
Put #1, , "/get port_name" + Chr$(10)

' get the response from driver which should contain the
' com port number
Get #1, , buf$

' Expected response:
' (character position in the response string)
'           11111111112222222222
'           12345678901234567890123456789
' e.g. "/get           port_name   COM14"

'+=====+
'| | IMPORTANT: CLOSE THE DEVICE DRIVER      | |
'| |           BEFORE TRYING TO REOPEN IT   | |
'+=====+
Close #1

' Make sure we got back a valid response.
' This checks that we have received a "/get" response and that
' "port_name" and "COM" are present and in the right locations.
If Left(buf, 4) = "/get" _
  And InStr(buf, "port_name") = 13 _
  And InStr(buf, "COM") = 25 Then

  ' Just for information, display the com port number
  txtInfo.Text = "Opening Serial IO on port " & Mid(buf, 25, 5)

  ' Get the port number value from character position 28
  ' (and 29 if two digits long) of the response
  PortNumber = Val(Mid(buf, 28, 2))

'+-----+
'| open the driver as a serial device |
'+-----+

' make sure the on_comm function will be
' triggered by the device driver by setting
' the receive threshold to 1 (one)
MSComm1.RThreshold = 1

```

```
' Set the com port number retrieved from the response
MSComm1.CommPort = PortNumber

' Open the com port and establish communications with the device
MSComm1.PortOpen = True

' enable the read button
btnRead.Enabled = True

txtInfo.Text = "Click on the Read button to read a" _
& "card or Exit to quit."
Else
' If we got here, then the device did not open correctly
' as a file IO so some kind of error handling is needed
txtInfo.Text = "Error: Got back: " & buf
End If

End Sub

'+-----+
'| Form_QueryUnload |
'+-----+-----+
'| When this form is closed make sure the port |
'| is closed |
'+-----+
Private Sub Form_QueryUnload(Cancel As Integer, UnloadMode As Integer)
  If MSComm1.PortOpen Then
    MSComm1.PortOpen = False
  End If
End Sub

'+-----+
'| MSComm1_OnComm |
'+-----+-----+
'| This event is automatically activated |
'| whenever the device driver returns data |
'| to the program |
'+-----+
Private Sub MSComm1_OnComm()

' If this event handler was called because data was
' received from the device (via the device driver), then
' process that data
'
' In this demo, it is just stored in the "RcvdData" buffer
If MSComm1.CommEvent = comEvReceive Then
  RcvdData$ = MSComm1.Input
End If
End Sub
```

C++ EXAMPLE

The following is an example of C++:

```

/* ----- */
/*           TST: Test Application           */
/*                                           */
/*           MTDTEST.C - Test module for Mag-Tek device drivers */
/* ----- */
/* Version 1.00                               $Revision::      $ */
/* ----- */

#include <windows.h>
#include <stdio.h>
#include <conio.h>
#include <string.h>

/* --- Static variables ----- */

static volatile BOOL    quit = FALSE;
static char             sbuff[128];
static HANDLE          drv_h;
static HANDLE          in_threadh;
static HANDLE          out_threadh;
static OVERLAPPED      ov_r, ov_w;

/* --- Macro definitions ----- */

#define OPEN_DEVICE(name) \
    CreateFile( \
        (name), \
        GENERIC_READ | GENERIC_WRITE, \
        0, \
        NULL, \
        OPEN_EXISTING, \
        0 | \
        FILE_FLAG_OVERLAPPED, \
        NULL \
    )

/* --- Internal Function Prototypes ----- */

void input_thread    (void *p);
void output_thread  (void *p);

/* --- Main ----- */

int main ( int argc, char *argv[])
{
    HANDLE    ret_h;
    DWORD    ws;
    DWORD    retdw;
    int      stage=1;

```

```
/** clear overlapped structure */
memset ( &ov_r, 0, sizeof (ov_r) );
memset ( &ov_w, 0, sizeof (ov_w) );

if (argc < 2)
    drv_h = OPEN_DEVICE ("COM5"); /* Must Specify proper COM# as default */
else
    drv_h = OPEN_DEVICE (argv[1]);
if (drv_h == INVALID_HANDLE_VALUE)
{
    ws = GetLastError();
    printf("Can NOT open device : %s. Error : 0x%lx", "", ws);
    return ( stage);
}

{ DCB dcb;
GetCommState(drv_h, &dcb);
dcb.BaudRate = CBR_9600;
dcb.Parity = NOPARITY;
dcb.ByteSize = 8;
dcb.StopBits = ONESTOPBIT;
dcb.fParity = 0;
dcb.fBinary = 1;
dcb.fOutxCtsFlow = 0;
dcb.fOutxDsrFlow = 0;
dcb.fDtrControl = DTR_CONTROL_ENABLE;
SetCommState(drv_h, &dcb);
}

#define STAGE(idx, op, msg) \
        ret_h = op; \
        if (ret_h==NULL) \
        { \
            printf("%s\n", (msg)); \
            break; \
        } \
        stage = idx;

do {
    STAGE ( 6, CreateEvent (NULL, TRUE, FALSE, NULL),
        "Can't Create Overlapped Event(read)" );
    ov_r.hEvent = ret_h;

    STAGE ( 7, CreateEvent (NULL, TRUE, FALSE, NULL),
        "Can't Create Overlapped Event(write)" );
    ov_w.hEvent = ret_h;

    STAGE ( 8,
        CreateThread(
            NULL, // address of thread security attributes
            0L, // initial thread stack size, in bytes
            (LPTHREAD_START_ROUTINE)output_thread, // adr of thread function
            NULL, // argument for new thread
            0L, // creation flags 0-run immediately
            &retdw // address of returned thread identifier
        ),
        "Can't Create output thread" );
    out_threadh = ret_h;
    STAGE ( 9,
        CreateThread(
```

```

        NULL,          // address of thread security attributes
        0L,           // initial thread stack size, in bytes
        (LPTHREAD_START_ROUTINE)input_thread, // addr of thread function
        NULL,        // argument for new thread
        0L,          // creation flags 0-run immediately
        &ret_dw      // address of returned thread identifier
    ),
    "Can't Create input thread" );
in_threadh = ret_h;
Sleep(100);
printf("\nTest Console started. (press <^Z> to terminate).\n");
} while (0);

switch ( stage)
{
case 9:
    WaitForSingleObject (in_threadh, INFINITE); printf ("\n");
case 8:
    quit = TRUE;
    ws = WaitForSingleObject ( out_threadh, 300);
    if (ws != WAIT_OBJECT_0)
    {
        DWORD ret_len;
    }
    SetEvent (ov_r.hEvent); //@@out_ev);
    ws = WaitForSingleObject ( out_threadh, INFINITE);
    CloseHandle ( out_threadh );
    CloseHandle ( in_threadh );
case 7: CloseHandle ( ov_w.hEvent );
case 6: CloseHandle ( ov_r.hEvent );
case 1: CloseHandle ( drv_h );
}

return (0);
}

/* --- Helpers ----- */

#define SINGLE_CHARS

void input_thread      (void *p)
{
    int  ch;
    DWORD ws;
    char str[100];

    ch = 0;
    while(!quit)
    {
#ifdef SINGLE_CHARS
        ch = getch();
        printf("%c", ch);
        if (ch == 13)
            printf("\n");
        if ( ch == 0 )
        {
            if (kbhit())
            {
                ch = 0x100 + getch();
            }
        }
#endif
    }
}

```

```

        }
    #else
    gets(str);
    strcat(str, "\n");
    ch = str[0];
    #endif
    switch (ch)
    {
    case 0x1a:          // <Ctrl-Z> - emergency exit
        printf("\n---Exit---\n");//@@
        quit = TRUE;
        break;
    default:
        if (ch < 0x100)
        {
            BOOL          rs;
            DWORD         ret_len;
            #ifdef SINGLE_CHARS
            rs = WriteFile(drv_h, &ch, 1, &ret_len, &ov_w);
            #else
            rs = WriteFile(drv_h, str, strlen(str), &ret_len, &ov_w);
            #endif
            if (!rs)
            {
                ws = GetLastError ();
                if ( ws != ERROR_IO_PENDING)
                    printf("DeviceIOControl (Write) Error : %i (0x%x)\n", ws, ws );
            }
            rs = GetOverlappedResult (
                drv_h,          // handle
                &ov_w,         // address of overlapped structure
                &ret_len,      // address of actual bytes count
                TRUE           // wait flag
            );
            if (!rs)
            {
                ws = GetLastError ();
                printf("Write Error : %i (0x%x)\n", ws, ws );
            }
        }
        else
        {
        }
        break;
    } /* switch (ch) */

    // give output thread chance to catch 'quit' character from driver
    // @@ there should be a better way to do this
    if (ch == 0x1b)
        Sleep(200);
}
}

#define BUFSZ 128

void output_thread (void *vp)

{
    BOOL          rs;

```

```

DWORD      read_len=0;
char       wbuff[1];
char*      p;

while (!quit)
{
    rs = ReadFile(drv_h, wbuff, sizeof(wbuff), &read_len, &ov_r);
    if ( !rs)
    {
        rs = GetLastError ();
        if ( rs != ERROR_IO_PENDING)
        {
            printf("DeviceIOControl (Read) Error : %i (0x%x)\n", rs, rs );
            break;
        }
    }
    rs = WaitForSingleObject ( ov_r.hEvent, INFINITE);
    rs = GetOverlappedResult (
        drv_h,          // handle of file, pipe, or communications device
        &ov_r,          // address of overlapped structure
        &read_len,      // address of actual bytes count
        FALSE           // wait flag
    );
    if (quit)
        break;
    if ( rs )
    {
        p = wbuff;
        while (read_len >0)
        {
            if (*p == 0x1a)
            {
                quit = TRUE;
                printf("\n\nExiting Test...");
                break;
            }
            putchar (*p);
            ++p;
            --read_len;
        }
    }
}
};
// end of file

```

POWER BUILDER EXAMPLE

The following example illustrates how to set up PowerBuilder (from Sybase) to read magnetic data from the IntelliPIN device. Since PowerBuilder does not interface to a serial port very easily, a third-party OCX is required. The first part of this application note shows how to load an ActiveX component. The main program script shows how to interface with the OCX, the MTD Windows Driver, and the MagTek device (in this case the IntelliPIN).

The following communication ActiveX components are available for use with PowerBuilder:

Product	Company	Web Site	Phone
IO ActiveX Control	Software Island	members.aol.com/easyio	N/A
Comm Library	EllTech	elltech.com	800-227-8047
COMM-DRV/LIB	WCSC	www.wcscnet.com	800-966-4832

In our example, we have chosen “IO ActiveX Control” from Software Island. Here is a method that can be used to install this component:

1. In a PowerBuilder application, open a new window.
2. From the “Controls” dropdown menu, select “OLE”.
3. From the “Create New” tab, select the intended OCX, for example, “IO Control”. (It is assumed that the OCX has already been registered by installing it according to the manufacturer’s directions.) Then click “OK”.
4. Left click anywhere on the open window and drop the component onto it.
5. Right click on the newly installed component and select “Properties”. Enter “mtd” into the “Name” text field. Enter “MTD OCX” into the “Display Name” and “Tag” text fields. Click “OK”.
6. Right click anywhere on the window outside the new component then select “Properties”. Enter “ole_io” into the “Title:” text field. Deselect the “Visible” check-off box so the window will not be shown then click “OK”.
7. Right click anywhere on the window outside the new component then select the “Script” option. Insert the following script into the “ole_io” window.

```
////////////////////////////////////  
// Window Script to load OCX for Mag-Tek Driver. //  
// This is the script for the invisible window that //  
// contains the OLE object. //  
////////////////////////////////////  
integer result  
  
result = mtd.object.Open("COM5:", "")  
// COM5 is the virtual port name which was automatically  
// assigned to IntelliPIN RS-232 Driver upon installation.  
// It may be different for your installation.  
  
if result < 1 then  
    MessageBox("Open Read",result)  
    return 0  
END if
```

8. Close the PowerScript Painter window and answer "Yes" to "Save changes...".
9. Close the Window Painter window and answer "Yes" to "Save changes...". At the "Save Window" dialog box, enter "ole_io" then click "OK".
10. Open the PowerScript window for the main application and integrate the following commands into the application. (This demo application prompts the user to read a card. The program will continue to loop until the "Cancel" button is pushed.)

```

////////////////////////////////////
//   Application to demonstrate use of OLE ActiveX Component   //
//   to interface to Mag-Tek Windows Drivers (MTD).           //
////////////////////////////////////
string response
integer result

// Open ActiveX frame window to load the ole_io control.
// This may take a few seconds while the port is opened.
Open (ole_io)

// Include any commands required for your application.

// Specify the number of seconds to wait for card to be read
ole_io.mtd.object.SetTimeout(120)
// Define the message to be shown on the IntelliPIN to read a card.
// The end of line (~n) must be inserted for driver commands.
ole_io.mtd.object.WriteString("/set msg1 Read a Card~n")

NextCard:
// Request the card to be read.
ole_io.mtd.object.WriteString("/read card~n")
// Wait for the card to be swiped.
response = ole_io.mtd.object.ReadString(250)
// See if the card was read.
if response <> "" then
    // Remove "PIN Pad is processing" Display from IntelliPIN
    ole_io.mtd.object.WriteString("/display Thank You~n")
    // Show the card data in a Message window.
    result = MessageBox("Read Card?", response, Exclamation!, OKCancel!)
    else
    // It was a timeout from the OCX.
    // Must cancel the active command if the read was not performed.
    result = ole_io.mtd.object.WriteString("/cancel read~n")
    //ignore the response to cancel
    response = ole_io.mtd.object.ReadString(50)
end if
if result = 1 then
    goto NextCard
end if

```

APPENDIX A. INSTALLATION AND SETUP

The distribution disks contain the MTD Driver files for many of the MagTek products. In addition to the drivers, there are number of files that are required to support the installation and operation of these drivers. The disk contents are listed in the tables below.

Some of the Drivers support multiple configurations of the associated product. For example, the IntelliPIN Driver (IPIN.VXD) provides an interface vehicle for three different interface configurations. When a Driver is installed, be sure to select the proper interface type for your installation.

After installing a driver, you will be given the option of adjusting the **Port Name** (virtual port) and the **Connect to** (physical port) values. The **Port Name** is the COMxx port by which the device will be addressed. The **Connect to** is the port that the device is physically attached to on the PC.

INSTALLING DEVICE DRIVERS (W95/98/ME)

File or Directory Name	Device Friendly Name	DESCRIPTION
OEMSETUP.INF		Installation descriptor file
README.TXT		Describes the disk file contents and provides installation procedures
\W95_DRV	Directory	The following Windows 95/98/ME device drivers are located in this directory:
DMAPLD.VXD		DriverMagic Advanced Part Library
DMVXD.VXD		DriverMagic engine
DMVXDD.VXD		DriverMagic Windows 9x/ME Driver Part Kit
GENERIC.VXD		Generic Driver that allows communication with any device using any command format.
IPIN.VXD	IntelliPIN RS-232 IntelliPIN Wedge IntelliPIN MICR Aux	IntelliPIN Driver (RS-232, keyboard, and MICR+ aux port interfaces)
MAGCDFLT.DLL		Resource DLL for the default locale
MAGCDFLT.HLP		Default Help File
MAG-TEKCL.DLL		Class Installer
MAG-TEKCL.VXD		Class driver for Windows 9x/ME
MAGWEDGE.VXD	Mag-Wedge	Mag-Wedge Driver (keyboard interface)
MICRPLUS.VXD	MICR+	MICR Plus Driver (RS-232 interface)
MINIMICR.VXD	Mini MICR RS-232 Mini MICR Wedge	Mini MICR Driver (RS-232 and keyboard interfaces)
MINIWEDG.VXD	MiniWedge	Mini-Wedge Driver (keyboard interface)
MT85.VXD	MT-85	MT-85 Driver (RS-232 interface)
MT95.VXD	MT-95	MT-95 Driver (RS-232 interface)
MTPPINSR.VXD	Port-powered insert reader	Port Powered Insert Driver (RS-232 interface)
MTPPSWIP.VXD	Port-powered swipe reader	Port Powered Swipe Driver (RS-232 interface)

If problems occur when adding or updating drivers, it may be necessary to remove previous versions. See the ***“Removing the Driver (W95/98/ME)”*** section later in this document for instructions on how to uninstall the driver.

General Notes:

1. The computer and device should be powered off when connecting any devices.
2. Although you do not have to have the device connected to install the driver, it is highly recommended. This allows the device and driver to be tested when the driver is installed.
3. Note which hardware port each device is using on the computer as this information will be used later in the driver installation process.
4. Because of a bug in Win95 installer, if an installation image is put in a location with a long filename, the installer does not find it and says, "the specified location does not contain information about your hardware". To avoid that problem, put the installation image in the directory that does not contain long filenames in its full path.

Adding the First Device Driver (W95/98/ME)

1. Start Windows.
2. Open the Control Panel and double click on the "Add New Hardware" icon.
3. Click the **Next** button to advance to the first input screen. (In Windows 98/ME, you will have to click **Next** one more time.)
4. Select the **No** radio button when asked if you want Windows to search for your new hardware and click the **Next** button.
5. Select **Other devices** from the list then click the **Next** button. (If MagTek is included in the "hardware types" list, go to **Adding Another Device Driver (W95/98/ME)**)
6. Click on the **Have Disk** button.
7. Insert the driver program disk into the CD drive and enter **d:** into the dialog or use **Browse** to point to where the installation file (oemsetup.inf) is located; click the **OK** button on the dialog box.
8. Select the device to be installed from the list of models and click the **Next** button.
9. Click the **Finish** button. The computer will take a moment to install the driver. Please be patient. (**Do NOT click the "Finish" button again!**)
10. If the computer displays a message stating "System Settings Change" and requests that you restart the computer, please do so.
11. Continue with **Completing the Installation (W95/98/ME)** below.

Adding Another Device Driver (W95/98/ME)

If at least one driver is already installed, follow these steps:

1. Start Windows.
2. Open the Control Panel and double click on the "Add New Hardware" icon.
3. Click the **Next** button to advance to the first input screen. . (In Windows 98/ME, you will have to click **Next** one more time.)
4. Select the **No** radio button when asked if you want Windows to search for your new hardware and click the **Next** button.

5. Select **MagTek** from the list of Hardware Types, then click the **Next** button.
6. Select the device to be installed from the displayed list box and click the **Next** button.
7. Click the **Finish** button. The computer will take a moment to install the driver. Please be patient. If the installation file cannot be found, click **Browse** and point to where the installation file (oemsetup.inf) is located; click the **OK** button on the dialog box.
8. If the computer displays a message stating “System Settings Change” and requests that you restart the computer, please do so.
9. Continue with **Completing the Installation (W95/98/ME)** below.

Updating an Installed Device Driver (W95/98/ME)

When a newer version of a driver is available, use these steps to update it:

1. Start Windows.
2. Right-click on **My Computer** on the desktop or open the Control Panel and double click on the **System** icon then select **Properties**.
3. Click on the Device Manager tab.
4. Click on the plus sign in front of the MagTek list item to expand it.
5. Double click on the driver to be updated or click once on the driver then click the **Properties** button.
6. Click on the Driver tab.
7. Click on the Update Driver button.
8. Select the **No** radio button when asked if you want Windows to search for your new hardware and click the **Next** button.
9. Select **MagTek** from the list, if shown, then click the **Next** button.
10. Select the device to be installed from the displayed list box and click the **Next** button.
11. Click the **Finish** button. The computer will take a moment to install the driver. Please be patient.
12. If the computer displays a message stating “System Settings Change” and requests that you restart the computer, please do so.
13. Continue with **Completing the Installation (W95/98/ME)** below.

Completing the Installation (W95/98/ME)

The Windows Add New Hardware Wizard will install the selected driver. If this is the first time a MagTek device driver is installed, it will also add the **MagTek** device class in the Device Manager.

When the installation has been completed, the device configuration property sheet will be displayed (the window title is **Installed Device**). Perform the following steps to configure the device:

1. Either accept the default selection for the virtual **Port Name** or select the desired port (COM5-COM15) to be associated with the device from the **Port Name** combo box and modify the device's friendly name if the default is not acceptable.
2. Select the port to which the device is connected (see *General Notes* in **Installing Device Drivers (W95/98/ME)** above) from the **Connect to** combo box.
3. Click on the **Test** button to validate the port settings and verify the device's presence. (The **Test** function only works on virtual COM ports 5 through 10. The test will fail on COM11-15 but the device will still be accessible from any application.)
4. Click **OK** to save the settings.
5. If the computer displays a message stating 'The specified "Connect To" port is used by another device...' make sure the "Connect To" port settings is correct. If it is (multiple devices can share a single port, but only one at a time can be selected), click on the **OK** button to finish the installation. Otherwise, click on the **Cancel** to change the port.

Modifying A Device Driver's Settings (W95/98/ME)

To modify the device driver's settings, perform the following steps:

1. Right-click on **My Computer** on the desktop or open the Control Panel and double click on the **System** icon then select **Properties**. See Figure A-1.
2. Select the **Device Manager** tab.
3. Expand the **MagTek** class by clicking the plus sign. Find the required device under the **MagTek** class then click on **Properties**.
4. Select the **Settings** tab to view the driver configuration. **Port Name** indicates the virtual port number and **Connect to** indicates the physical port.
5. Click the **Advanced** button (see Figure A-2) to view the communication settings. Some devices (e.g., MICR+) support automatic settings, which allow the driver to determine the present setup of the device. If required, click the **Specify settings manually** radio button and modify the communication setup. Click **OK** when done.

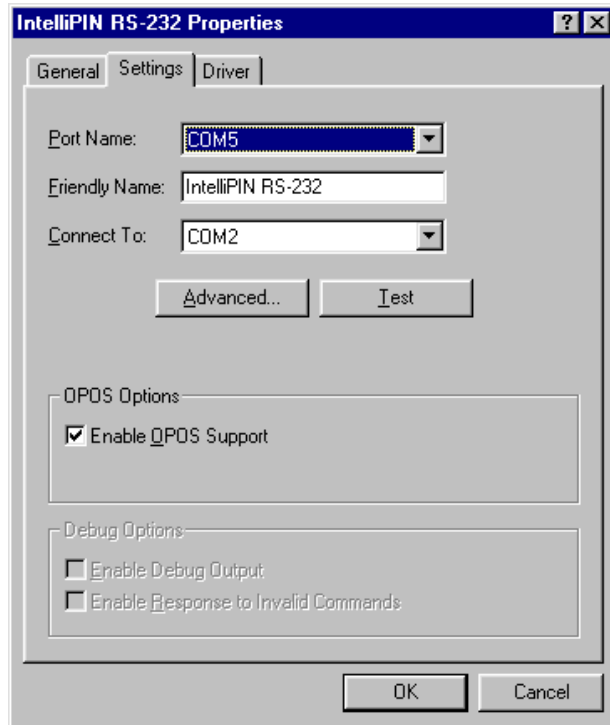

Figure A-1. Properties Settings, Windows 95/98/ME

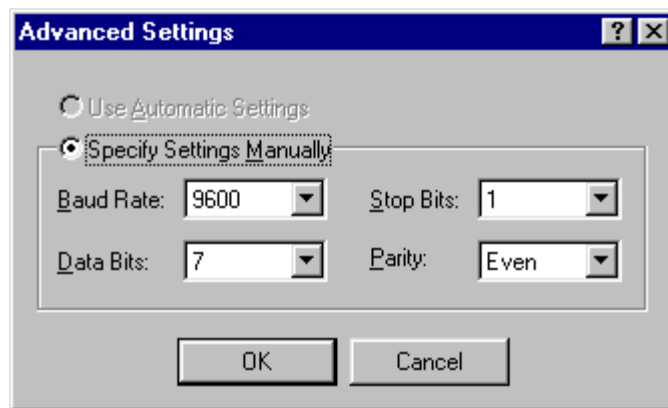

Figure A-2. Advanced Settings, Windows 95/98/ME

Removing the Drivers (W95/98/ME)

Caution

The following assumes familiarity with the Registry Editor. Improper use of the Registry Editor can cause Windows to cease to function. Please follow the instructions carefully.

Complete removal of the drivers requires two steps: (1) remove the drivers from the system using the Device Manager and (2) remove the driver files manually after all devices have been removed by the Device Manager.

To remove the drivers, follow these steps:

1. Stop any applications that are using the drivers. This will insure that all of the ports that are going to be removed are closed.
2. Right-click on **My Computer** on the desktop or open the Control Panel and double click on the **System** icon then select **Properties**.
3. Select the **Device Manager** tab and click on the plus sign at MagTek.
4. Select the device under the **MagTek** group and click on **Remove**. Then click **OK**. After all device drivers have been removed in this manner, go to step 5.
5. Using Explorer or some other file manager, remove the following driver VXD's from

C:\Windows\System:

**GENERIC.VXD
 IPIN.VXD
 MAGWEDGE.VXD
 MICRPLUS.VXD
 MINIMICR.VXD
 MINIWEDG.VXD
 MT85.VXD
 MT95.VXD
 MTPPINSR.VXD
 MTPPSWIP.VXD**

The driver files may be removed only if no drivers are currently installed that require them. In particular, the class driver (MAG-TEKCL.VXD) must remain if any device type is still installed. The driver files may be removed when all devices of that particular type have been removed.

6. Remove the support files from **C:\Windows\System**. The support files are:

**DMAPLD.VXD
 DMVXD.VXD
 DMVXDD.VXD
 MAG-TEKCL.DLL
 MAG-TEKCL.VXD
 MAGCDFLT.HLP**

MAGCDFLT.DLL
MAGCxxx.HLP (locale specific)
MAGCxxx.DLL (locale specific)

7. Find and remove the copy of the **Mag-TekOEMSETUP.INF** file made by Windows. In release 1 of Windows 95, it is located in **C:\Windows\inf**. With the OSR2 release of Windows 95 (Win95B) and Windows 98/ME, the files will be located in **C:\Windows\inf\other**.
8. Run the Registry Editor by clicking on **Start** button then select **Run**. Type **REGEDIT** into the text box and press the Enter key.
9. Delete the following sub-trees from the registry:
HKEY_LOCAL_MACHINE\Software\Mag-Tek\ClassMap and
HKEY_LOCAL_MACHINE\System\CurrentControlSet\Services\Class\Mag-Tek.
10. When in Windows 95, remove the following values from the registry:

HKEY_LOCAL_MACHINE\System\CurrentControlSet\Control\InstalledFiles

DMAPLD.VXD
DMVXD.VXD
DMVXDD.VXD
IPIN.VXD
MAGCDFLT.DLS
MAGCDFLT.HLP
MAG-TEKCL.DLS
MAG-TEKCL.VXD
MAGWEDGE.VXD
MICRPLUS.VXD
MINIMICR.VXD
MINIWEDG.VXD
MT85.VXD
MT95.VXD
MTPPINSR.VXD
MTPPSWIP.VXD

11. When in Windows 98/ME, remove the following values from the registry:

HKEY_LOCAL_MACHINE\Software\Microsoft\Windows\CurrentVersion\Setup\SetupX\Inf\OEMName

%windir%\inf\other\MAGTE~1.INF
%windir%\inf\other\MAG-TEKOEMSETUP.INF

HKEY_LOCAL_MACHINE\System\CurrentControlSet\Control\Installed Files\Rename

MAGCDFLT.DLS
MAG-TEKCL.DLS

HKEY_LOCAL_MACHINE\System\CurrentControlSet\Control\SessionManager\Known16DLLs

MAG-TEKCL.DLL

12. Close the Registry Editor by selecting **File / Exit**.

INSTALLING DEVICE DRIVERS (WNT)

File or Directory Name	Friendly Name	DESCRIPTION
OEMSETUP.INF		Installation descriptor file
README.TXT		Describes the disk file contents and provides installation procedures
\WNT_DRV	Directory	The following Windows NT device drivers are located in this directory:
DMAPLD.DLL		DriverMagic Advanced Part Library
DMNTK.DLL		DriverMagic engine
DMNTKD.DLL		DriverMagic Windows 9x/ME Driver Part Kit
GENERIC.SYS		Generic Driver that allows communication with any device using any command format.
IPIN.SYS	IntelliPIN RS-232 IntelliPIN Wedge IntelliPIN MICR Aux	IntelliPIN Driver (RS-232, keyboard, and MICR+ aux port interfaces)
MAG-TEKCL.SYS		Class driver for Windows 95
MAGWEDGE.SYS	Mag-Wedge	Mag-Wedge Driver (keyboard interface)
MICRPLUS.SYS	MICR+	MICR Plus Driver (RS-232 interface)
MINIMICR.SYS	Mini MICR RS-232 Mini MICR Wedge	Mini MICR Driver (RS-232 and keyboard interfaces)
MINIWEDG.SYS	MiniWedge	Mini-Wedge Driver (keyboard interface)
MT85.SYS	MT-85	MT-85 Driver (RS-232 interface)
MT95.SYS	MT-95	MT-95 Driver (RS-232 interface)
MTCFG.EXE		Command-line configuration utility
MTD_KBH.SYS		Keyboard hook Driver
MTPPINSR.SYS	Port-powered insert reader	Port Powered Insert Driver (RS-232 interface)
MTPPSWIP.SYS	Port-powered swipe reader	Port Powered Swipe Driver (RS-232 interface)

In Windows NT, only users with Administrator privileges may install system components. Log on as Administrator (or as a user with full administrative privileges) before attempting to install the MTD driver.

It is important to uninstall the previous version of MTD and re-boot the system before installing this version of the driver. The installation script provided cannot upgrade MTD from versions prior to version 1.09. The old driver can be uninstalled by using the Windows NT Installation

Wizard. Open the Wizard by double clicking on the Add/Remove Programs icon in the Control Panel. On the Install/Uninstall tab. Find and select the entry that reads

MTD preliminary release (uninstall)

or

Mag-Tek Device Drivers (MTD) - uninstall,

then click on the Add/Remove button. Re-boot the system after uninstalling the old version.

Installing the Driver Binaries (WNT)

To install the driver binaries (*.SYS), follow these steps:

1. Insert the installation media and open the drive using Windows Explorer.
2. Select the OEMSETUP.INF file and run the “Install” command from Explorer’s “File” menu.
3. Windows NT will not display any messages if the installation completes successfully. If there are any problems, an error message will be shown. If a file cannot be located, use the browse button to find it.
4. Restart the system to load the MTD drivers.

Note

If, during the installation, a strange behavior is observed - failure, or some other unexpected error—a system reboot is necessary before continuing or repeating the failed operation.

Uninstalling the Drivers (WNT)

Close any application that may have the MTD driver open before attempting to uninstall it. Failure to do this will cause the uninstallation to fail—after that the system must be re-booted before a subsequent attempt to uninstall the driver could be performed.

The driver can be uninstalled by using the Windows NT Installation Wizard. Open the Wizard by double-clicking on the Add/Remove Programs icon in the Control Panel. On the Install/Uninstall tab, find and select the entry that reads

Mag-Tek Device Drivers (MTD) - uninstall

then click on the Add/Remove button. Administrative privilege is required to perform this operation. The uninstallation removes all MTD files and adjust the registry as required. The system must be re-booted to remove the keyboard hook driver from memory. Reinstallation will fail if the system is not re-booted after uninstalling the driver.

INSTALLING DEVICE DRIVERS (W2000/XP)

File or Directory Name	Friendly Name	DESCRIPTION
MTD_KBH.INF		Keyboard hook installation descriptor file
MTD_KBH.SYS		Keyboard hook Driver
OEMSETUP.INF		Installation descriptor file
README.TXT		Describes the disk file contents and provides installation procedures
\I386	Directory	Microsoft keyboard drivers
\W2K_DRV	Directory	The following Windows 2000/XP device drivers are located in this directory:
DMNTK.DLL		DriverMagic engine
DMNTKD.DLL		DriverMagic Windows Driver Part Kit
GENERIC.SYS		Generic Driver that allows communication with any device using any command format.
IPIN.SYS	IntelliPIN RS-232 IntelliPIN Wedge IntelliPIN MICR Aux	IntelliPIN Driver (RS-232, keyboard, and MICR+ aux port interfaces)
MAGTEKCL.SYS		Class driver for Windows 95
MAGWEDGE.SYS	Mag-Wedge	Mag-Wedge Driver (keyboard interface)
MICRPLUS.SYS	MICR+	MICR Plus Driver (RS-232 interface)
MINIMICR.SYS	Mini MICR RS-232 Mini MICR Wedge	Mini MICR Driver (RS-232 and keyboard interfaces)
MINIWEDG.SYS	MiniWedge	Mini-Wedge Driver (keyboard interface)
MT85.SYS	MT-85	MT-85 Driver (RS-232 interface)
MT95.SYS	MT-95	MT-95 Driver (RS-232 interface)
MTCFG.EXE		Command-line configuration utility
MTPPINSR.SYS	Port-powered insert reader	Port Powered Insert Driver (RS-232 interface)
MTPPSWIP.SYS	Port-powered swipe reader	Port Powered Swipe Driver (RS-232 interface)

In Windows 2000/XP, only users with Administrator privileges may install system components. Log on as Administrator (or as a user with full administrative privileges) before attempting to install the MTD driver.

It is important to uninstall the previous version of MTD and re-boot the system before installing this version of the driver. The installation script provided cannot upgrade MTD from versions prior to version 1.10. The old driver can be uninstalled by using the Windows 2000/XP Installation Wizard. Open the Wizard by double clicking on the Add/Remove Programs icon in the Control Panel. On the Install/Uninstall tab. Find and select the entry that reads

MTD preliminary release (uninstall)

or

Mag-Tek Device Drivers (MTD) - uninstall,

then click on the Add/Remove button. Re-boot the system after uninstalling the old version.

Installing the Driver Binaries (W2000/XP)

To install the driver binaries, follow these steps:

1. Insert the installation media and open the drive using Windows Explorer.
2. Select the OEMSETUP.INF file and run the "Install" command from Explorer's "File" menu.
3. Windows 2000/XP will not display any messages if the installation completes successfully.
4. Open the Control Panel and double click on the "System" icon.
5. Click on the "Hardware" tab.
6. Click on the "Device Manager" button.
7. Click on the '+' to expand the "Keyboards" entry in the Device Manager list.
8. Right click on the "PC/AT Enhanced PS/2 Keyboard (101/102-Key)" entry.
9. Click the "**Properties**" item in the dialog box.
10. Click on the "Driver" tab.
11. Click the "Update Driver" button.
12. Click the "**Next**" button to advance to the first input screen.
13. Select the "Display a list of the known drivers..." radio button.
14. Click the "**Next**" button to advance to the next input screen.
15. Click on the "Have Disk" button.
16. Enter installation drive and directory in the "Copy Manufacturer's file from:" text box.
17. Click the "**Next**" button to advance to the next input screen.
18. Click on "**Yes**" to the "Update Driver Warning".

19. Click the “**Next**” button to advance to the next input screen.
20. Click on “**Yes**” to the “Digital Signature Not Found”.
21. Click “Finish”.
22. Click “Close” on the “System” dialog.
23. Answer “**Yes**” to the “Restart System” prompt.

Note

If, during the installation, a strange behavior is observed - failure, or some other unexpected error—a system reboot is necessary before continuing or repeating the failed operation.

Uninstalling the Drivers (W2000/XP)

Close any application that may have the MTD driver open before attempting to uninstall it. Failure to do this will cause the uninstallation to fail—after that the system must be re-booted before a subsequent attempt to uninstall the driver could be performed.

The driver can be uninstalled by using the Windows Installation Wizard. Open the Wizard by double-clicking on the Add/Remove Programs icon in the Control Panel. On the Install/Uninstall tab, find and select the entry that reads

Mag-Tek Device Drivers (MTD) - uninstall

then click on the Add/Remove button. Administrative privilege is required to perform this operation. The uninstallation removes all MTD files and adjusts the registry as required.

Uninstalling the Keyboard Hook Driver (W2000/XP)

For Windows 2000/XP, the keyboard hook driver must be uninstalled after the driver binaries (cf. above) are uninstalled and before rebooting.

1. Open the Control Panel and double click on the “System” icon.
2. Click on the “Hardware” tab.
3. Click on the “Device Manager” button.
4. Click on the ‘+’ to expand the “Keyboards” entry in the Device Manager list.
5. Right click on the “PC/AT Enhanced PS/2 Keyboard (101/102-Key)” entry.
6. Click the “**Properties**” item in the dialog box.
7. Click on the “Driver” tab.
8. Click the “Update Driver” button.
9. Click the “**Next**” button to advance to the first input screen.
10. Select the “Search for a suitable driver... ” radio button.
11. Click the “**Next**” button to advance to the next input screen.

12. Uncheck all "Optional search locations" check boxes.
13. Click the "Next" button to advance to the next input screen.
14. Click the "Next" button to advance to the next input screen.
15. Answer "Yes" to the "Confirm Driver Install". (Note: This uninstallation procedure may hang at step 15. This is a non-disruptive hang-up. User should wait 10 seconds and do a hard re-boot. Windows 2000/XP should recover without a system check or scan disk.)
16. Click "Finish".
17. Click "Close" on the "System" dialog.
18. Answer "Yes" to the "Restart System" prompt.

WINDOWS NT/2000/XP CONFIGURATION UTILITY

To add or set up MagTek devices, use the MTCFG.EXE utility. It is installed by the installation procedure described above. The examples below show a typical setup of a keyboard device and a serial device. For a more detailed description of the MTCFG.EXE utility, see "Using the MTCFG Utility (WNT/2000/XP)" below. As with the driver installation, this phase requires the current user to have Administrator privileges.

A device does not have to be physically connected at the time when it is set up. The driver will only access the device when it is opened.

The installation procedure consists of two phases: (a) installing the driver binaries and (b) configuring MagTek devices.

No re-boot is necessary after adding a device with MTCFG.

Adding a Keyboard Device (WNT/2000/XP)

The MiniWedge is used in the following example:

1. Select an unused COM port number for the device. Choose any number between 5 and 255 that is not used by other devices (if in doubt, check the Ports Control Panel—it displays all COMx names currently used).
2. Enter the following command at the DOS command prompt (the example assumes COM5 was selected):

```
mtcfg COM5 "MiniWedge" "FriendlyName=MiniWedge"
```
3. The third argument ("FriendlyName=...") is optional and may be omitted if no friendly name is needed. Quotes are required around arguments if they include spaces.
4. If the device is added successfully, MTCFG will display the following prompt:

```
Re-starting MTD driver - close all applications using MTD.  
Press <Enter> to restart MTD
```
5. Press the Enter key to complete the MTD configuration—if the operation was successful, the configuration utility displays:

MTD was successfully re-started. The changes you made are now in effect.

Note

Only a single keyboard device can be installed at a time.

Adding a Serial Device (WNT/2000/XP)

Mini MICR is used in the following example:

1. Select an unused COM port number for the device. Choose any number between 5 and 255 that is not used by other devices (if in doubt, check the Ports Control panel—it displays all COMx names currently used). MTCFG will verify that the COM name selected is not used by another MagTek device, but it will not check against non-MagTek devices.
2. Select a serial port to which the device will be attached (any standard serial port may be used; do not use the name of an existing MagTek device here). MTCFG allows multiple MagTek devices to be configured as attached to the same port—in this case these devices cannot be opened simultaneously.
3. Enter the following command at the NT command prompt (the example assumes that the device is physically connected to COM2 and MTD device will appear as COM6):

```
mtcfg COM6 "Mini MICR RS-232" UsePort=COM2 "FriendlyName=Mini MICR RS-232"
```

The value specified for **UsePort** must be all uppercase (e.g., use **COM2**, not **com2** or **Com2**). The fourth argument (“FriendlyName=...”) is optional and may be omitted.

4. If the device is added successfully, MTCFG will display the following prompt:

```
Re-starting MTD driver - close all applications using MTD.
Press <Enter> to restart MTD
```
5. Press the Enter key to complete the MTD configuration—if the operation was successful, the configuration utility displays:

```
MTD was successfully re-started. The changes you made are now in effect.
```

Adding an ‘IntelliPIN MICR Aux’ Device (WNT/2000/XP)

Before installing the IntelliPIN Aux device, make sure that the MICR+ device has been successfully installed and opened. If the device has not been successfully opened, the MICR+ device may not be properly configured to operate with a device attached to its auxiliary port thereby preventing the IntelliPIN Aux device from opening. Additionally, make sure that the communication settings for both devices are identical. When using both the MICR+ and the IntelliPIN drivers, the MICR+ driver must be opened before the IntelliPIN driver and closed after the IntelliPIN driver is closed.

The procedure for adding an “IntelliPIN MICR Aux” device is similar to the procedure for adding a serial device. The only difference is that the “UsePort” parameter must be “AUX port on ” followed by the friendly name or port name of the device to which the device is attached. (The example assumes that the device is physically connected to auxiliary port of MICR+ device

and MTD device will appear as COM7. The MICR+ device appears to the system as COM12 and has a friendly name : MICR+.) Two examples are shown:

```
mtcfg COM7 "IntelliPIN MICR Aux" "UsePort=AUX port on MICR+"  
"FriendlyName=IntelliPIN AUX"
```

OR

```
mtcfg COM7 "IntelliPIN MICR Aux" "UsePort=AUX port on COM12"  
"FriendlyName=IntelliPIN AUX"
```

Viewing the List of Configured Devices (WNT/2000/XP)

Execute MTCFG with no command line arguments. If the above examples have been used, the displayed result will be:

port	Conn. to	model	friendly name
COM5		MiniWedge	MiniWedge
COM6	COM1	Mini MICR RS-232	Mini MICR RS-232
COM7	AUX port on MICR+	IntelliPIN MICR Aux	IntelliPIN AUX

Using the MTCFG Utility (WNT/2000/XP)

MTCFG.EXE is a command-line utility installed with the MTD drivers. It requires that the driver binaries be correctly installed, as described in the previous sections. MTCFG cannot be used to install the driver binaries; running it from the installation media before the driver has been installed will result in the following error message:

```
Mag-Tek driver is not correctly installed. Please install the driver  
before using this program.
```

The same message will be displayed if the installation has been modified manually, e.g., the installation script has been renamed or removed or the driver's Registry data has been removed.

It is recommended that all applications that may have opened a MagTek device be terminated before using MTCFG to change a device's configuration, or to add or remove a device.

Command syntax summary

Command Syntax	Meaning
<code>mtcfg</code>	list installed MagTek device drivers
<code>mtcfg -?</code>	display a help page
<code>mtcfg -help</code>	display a help page
<code>mtcfg -models</code>	list available MagTek device models
<code>mtcfg <i>port-name</i></code>	list settings for a given device
<code>mtcfg <i>port-name</i> -all more</code>	verbose list of settings
<code>mtcfg <i>port-name</i> <i>model</i> [<i>settings</i>]</code>	* add and configure a new device
<code>mtcfg <i>port-name</i> -delete</code>	* delete a device
<code>mtcfg <i>port-name</i> <i>settings</i></code>	* change settings for a device

* these commands require Administrator privilege. MTCFG will display an error message if the current user is not an Administrator.

Displaying Configuration Information (WNT/2000/XP)

To display the list of configured MagTek devices, use the following syntax:

```
mtcfg
```

To display the settings for a single device, use:

```
mtcfg COMx
```

COMx is the name (virtual port) of the device, as set when the device was first configured. This name is shown in the leftmost column in the list of devices. This command displays only the common settings for the device—the ones that are most likely to require modification. To display all device settings, including all data parsing format strings, use the following syntax:

```
mtcfg COMx -all | more
```

The pipe symbol and “more” will present the information one screen at a time.

Adding New Devices (WNT/2000/XP)

To add a new device use the following command syntax:

```
mtcfg port-name model
```

or

```
mtcfg port-name model settings
```

port-name is the name (virtual port) chosen for the new device. It must not be used by another device in the system (MagTek or other). The port name in the form COMxxx (valid values are COM5 .. COM255). MTCFG will verify that the name is not used by other MagTek devices that were set up with this utility, but it will not check whether the name is used by any other device in the system.

- model* is the full name of the device model to be added. The name should be enclosed in quotes if it contains spaces. Use "mtcfg -models" to see a list of models. The model names used by MTCFG are the ones specified in the [Models] section of the MTD installation script (OEMSETUP.INF).
- settings* specifies one or more device settings in the form *name=value*. The syntax for these is identical to the syntax used when modifying the settings of an already installed device. See the next section for a list of common settings. Specifying any settings when adding a device is optional—they can always be specified later (see the next section), but it is recommended to include at least those settings that are required for the device to operate, e.g., UsePort for serial devices.

Configuration Examples for Windows NT/2000/XP

These examples are for illustration only. Most of the command line entries will have to be modified to accommodate the actual installation.

Device or driver	Command Line	Comment
Generic RS-232	MTCFG COM5 "Generic Serial (RS-232)" FriendlyName=MT-80 UsePort=COM1 baud=4800 parity=0 datasize=7	Be sure to specify the proper communication parameters for the selected device.
Generic KB	MTCFG COM6 "Generic Wedge (Keyboard)" FriendlyName=MagReader	"UsePort" is not required for keyboard devices.
IntelliPIN RS-232	MTCFG COM7 "IntelliPIN MICR Aux" FriendlyName=IntelliPIN "UsePort=AUX port on MICR+"	The MICR+ driver must be installed before this driver.
IntelliPIN RS-232	MTCFG COM8 "IntelliPIN RS-232" FriendlyName=PINPad UsePort=COM2	Communication parameters may be required.
IntelliPIN KB	MTCFG COM9 "IntelliPIN Wedge" "FriendlyName=IntelliPIN KB"	Quotes are used for Friendly Name to allow the space.
Mag-Wedge	MTCFG COM10 "Mag-Wedge" "FriendlyName=Wedge Reader"	
MICR+	MTCFG COM11 "MICR+" FriendlyName=MICR+ UsePort=COM1	Communication parameters may be required.
Mini MICR RS-232	MTCFG COM12 "Mini MICR RS-232" FriendlyName=MICRS UsePort=COM1	Communication parameters may be required.
Mini MICR KB	MTCFG COM13 "Mini MICR Wedge" FriendlyName=MICRW	
MiniWedge	MTCFG COM14 "MiniWedge" FriendlyName=MSR	
MT-85	MTCFG COM15 "MT-85" "FriendlyName=MSR Encoder" UsePort=COM2	Communication parameters may be required.
MT-95	MTCFG COM16 "MT-95" FriendlyName=MT-95 UsePort=COM1 baud=9600 parity=-1 datasize=8	Communication parameters may not be required.
Port Powered Insert Reader	MTCFG COM17 "Port-powered insert reader" FriendlyName=PPInsert UsePort=COM1	No communication parameters are required.
Port Powered Swipe Reader	MTCFG COM18 "Port-powered swipe reader" FriendlyName=PPSwipe UsePort=COM2	No communication parameters are required.

Modifying a Device Driver's Settings (WNT/2000/XP)

Use the following syntax to change settings of a device:

```
mtcfg <port-name> <setting1> [<setting2> [<setting3>...]]
```

each of the settings is specified as

name=value

if *value* contains spaces, the whole *name=value* string should be enclosed in quotes (not just the value), e.g., to specify the string “MT-85 on COM1” as the friendly name for COM5 with a baud rate of 9600 bps, use the following syntax:

```
mtcfg COM5 "FriendlyName=MT-85 on COM1" baud=9600
```

Following is a list of common settings that can be changed for a device. Most settings have a default value and may be missing when the list of settings is requested for a device (e.g., by typing “MTCFG COM5”).

Name	Use
baud	(optional, used for serial devices only) device’s baud rate, specified as an integer (e.g., 9600)
parity	(optional, used for serial devices only) an integer specifying the parity used by the device: use -1, 0, 1, 2, or 3 for None, Even, Odd, Space and Mark parity respectively.
datasize	(optional, used for serial devices only) specifies the device’s serial word size in bits: 7 or 8.
stopbits	(optional, used for serial devices only) stop bits to use on transmission: 1 or 2.
UsePort	the serial port to which the device is connected. Must specify a valid standard serial port (or a port that is 100% compatible with a standard serial port).
FriendlyName	(optional) alternative name for the device. If specified, the device may be opened from user mode using this name (the prefix \\.\ must be added to the name. For example if FriendlyName=Port-powered swipe reader, this device can be opened as “\\.\Port-powered swipe reader”)
EnableFDP	(optional) Enable Flexible Data Parsing. Set this to 1 to enable data parsing and to 0 to disable data parsing.
PortName	Specifies the port name under which the device is visible to user-mode applications. Modifying this setting also changes the name used to refer to this device when using the MTCFG utility, e.g., if <pre>mtcfg COM5 PortName=COM8</pre> is executed, the device that was COM5, must be referred to as COM8 in any subsequent invocations of MTCFG. This setting is treated specially by MTCFG—it will validate the port name and make sure that it is not used by other MagTek devices before making the change.

Device settings other than the ones listed above should not be modified without carefully reviewing the driver’s engineering documentation for the specific device model.

Removing a Device (WNT/2000/XP)

To remove a MagTek device use the following command syntax:

```
mtcfg port-name -delete
```

The device is removed and all non-default settings specified for it are lost.

This operation does not remove any files from the system. To remove all devices and uninstall the MTD driver, follow the instructions in the next section.

MTD PROGRAMMING EXAMPLES

Example programs are included in the following directory:

File or Directory Name	DESCRIPTION
\EXAMPLES\CPP	Visual C++ example application (executable and source).
\EXAMPLES\DELPHI	MSCOMM and file I/O based Delphi sample applications (executables and sources)
\EXAMPLES\VB50	MSCOMM and file I/O based Visual Basic sample applications (executables and sources)
\EXAMPLES\PwrBldr	Power Builder example using the IntelliPIN

APPENDIX B. COMMAND LIST SUMMARY

This is a consolidated list of all available commands for the MagTek Windows Drivers.

Command	Description	Page
<i>/cancel cmd</i>	Cancel a command. <i>cmd</i> can be any of the transaction commands.	16
<i>/display [x]</i>	Display a message or two alternating messages on the LCD screen.	17
<i>/echo string</i>	Driver test command.	17
<i>/event n data</i>	Response to an unsolicited event notification.	18
<i>/get prop</i>	Get a property.	18
<i>/load key n key</i>	Load a key into the device.	19
<i>/rawrecv</i>	Receive data from the device	20
<i>/rawsend x</i>	Send arbitrary data to the device.	21
<i>/rawxact x</i>	Execute a send/receive transaction with the device in raw mode.	21
<i>/read [[x] y]</i>	Read data from the device.	22
<i>/reset</i>	Clear any pending operations and reset the device to initial state.	26
<i>/set prop val</i>	Set a property.	26
<i>/ver</i>	Read driver version.	26
<i>/write data</i>	Encode magnetic stripe command.	27

APPENDIX C. STATUS CODES

The following table defines the status codes returned in command responses. Note that it is not meant as a complete list of status codes—new codes may be added as necessary.

Value	Mnemonic and Description
00	successful operation
05	port already open
1F	wrong device ID
22	value, buffer, whatever may overflow
30	value not valid in operation context
31	value not valid in module's context
32	value out of range
34	text or formatted data syntax error
35	name invalid in module's context
40	internal error. Unexpected result from a system API
41	driver internal error
45	operation rejected (inappropriate state)
47	operation failed or not successful
60	I/O error (peripheral error)
62	requested item not found
63	duplicated item is not allowed
74	access type not appropriate / not possible
79	wrong device ID
81	a time-out has expired
82	operation cancelled on caller's request
83	operation aborted (on system, user or module's request)
93	feature not implemented
94	partial implementation or feature not supported

APPENDIX D. DEVICE DRIVER SUMMARIES

This section contains summaries of Device Drivers for the for the following models:

- IntelliPIN and IntelliPIN PLUS
- MagWedge Reader
- MiniWedge Reader
- MICR+ Reader
- Mini-MICR Reader
- Port Powered RS-232 Swipe Reader
- Port Powered RS-232 Insertion Reader
- MT-85 Encoder
- MT-95 Encoder

The summary for each model contains a list of the commands properties supported.

INTELLIPIN PINPAD & MSR

File Name IPIN.VXD

Part Number 30037395

Friendly Name(s) IntelliPIN RS-232, IntelliPIN Wedge & IntelliPIN MICR+ Aux

Remarks The Automatic Settings in the properties sheet are not supported; the communications must be specified manually. When using the IntelliPIN on the MICR+ Aux port, the MICR+ driver must be installed before the IntelliPIN driver; also the IntelliPIN driver must be closed before the MICR+ driver is closed.

Commands Supported					
/cancel cmd	✓	/load_key n key	✓	/reset	✓
/display [x]	✓	/rawrcv	✓	/set prop val	✓
/echo string	✓	/rawsend x	✓	/ver	✓
/event n data		/rawxact x	✓	/write data	
/get prop	✓	/read [[x] y]	✓		

Properties Supported								
Property	Yes	Default	Property	Yes	Default	Property	Yes	Default
account_no	✓		chk_mod10			msg3	✓	
amount	✓		chk_number			msg4	✓	
applied_fmt	✓		chk_routing			offline_enc		
c_card_stat			chk_status			oper_tout	✓	*
c_cardwpin	✓	1	chk_transit			pin_blk_fmt	✓	*
c_check		0	cmd_pending	✓		pinfilldig	✓	*
c_events			dblpinentry	✓	*	port_name	✓	
c_keypress	✓	1	dev_status	✓		pwroffdelay	✓	*
c_keystring	✓	1	dev_version	✓	*	s_down_tout	✓	*
c_magnetic	✓	1	enable_cmc7			track1ss	✓	
c_mechanics		0	enc_key	✓		track2ss	✓	
c_pin	✓	1	enc_key_sn	✓	*	track3ss	✓	
c_smart		0	enc_mode	✓	*	trivpinchk	✓	*
c_tracks	✓	111	entry_echo	✓		trk_enable	✓	*
c_write		0	entry_len	✓		trk1data	✓	
c_wr_secure			entry_tout	✓		trk2data	✓	
capitalize	✓	1	events_on			trk3data	✓	
card_stat			invalcmdrsp	✓		visa_mac1	✓	
chk_account			key_parity	✓	*	visa_mac2	✓	
chk_amount			lasterr	✓		visa_mac3	✓	
chk_bankid			max_pin_len	✓	*	wr_coer		
chk_data			msg1	✓		wr_secure		
chk_format			msg2	✓		xact_type	✓	d

* = Depends on setting in the device.

MAGWEDGE SWIPE READER

File Name MAGWEDGE.VXD **Part Number** 30037348
Friendly Name(s) MagWedge
Remarks The driver cannot determine which tracks are supported on the device, so the `c_tracks` and `trk_enable` properties will always indicate 111.

Commands Supported					
<code>/cancel cmd</code>	✓	<code>/load_key n key</code>		<code>/reset</code>	✓
<code>/display [x]</code>		<code>/rawrcv</code>	✓	<code>/set prop val</code>	✓
<code>/echo string</code>	✓	<code>/rawsend x</code>	✓	<code>/ver</code>	✓
<code>/event n data</code>		<code>/rawxact x</code>	✓	<code>/write data</code>	
<code>/get prop</code>	✓	<code>/read [[x] y]</code>	✓		

Properties Supported								
Property	Yes	Default	Property	Yes	Default	Property	Yes	Default
<code>account_no</code>			<code>chk_mod10</code>			<code>msg3</code>		
<code>amount</code>			<code>chk_number</code>			<code>msg4</code>		
<code>applied_fmt</code>	✓		<code>chk_routing</code>			<code>offline_enc</code>		
<code>c_card_stat</code>			<code>chk_status</code>			<code>oper_tout</code>		
<code>c_cardwpin</code>			<code>chk_transit</code>			<code>pin_blk_fmt</code>		
<code>c_check</code>		0	<code>cmd_pending</code>			<code>pinfilldig</code>		
<code>c_events</code>			<code>dblpinentry</code>			<code>port_name</code>	✓	
<code>c_keypress</code>			<code>dev_status</code>	✓		<code>pwroffdelay</code>		
<code>c_keystring</code>			<code>dev_version</code>			<code>s_down_tout</code>		
<code>c_magnetic</code>	✓	1	<code>enable_cmc7</code>			<code>track1ss</code>	✓	
<code>c_mechanics</code>		0	<code>enc_key</code>			<code>track2ss</code>	✓	
<code>c_pin</code>			<code>enc_key_sn</code>			<code>track3ss</code>	✓	
<code>c_smart</code>		0	<code>enc_mode</code>			<code>trivpinchk</code>		
<code>c_tracks</code>	✓	111	<code>entry_echo</code>			<code>trk_enable</code>	✓	111
<code>c_write</code>		0	<code>entry_len</code>			<code>trk1data</code>	✓	
<code>c_wr_secure</code>			<code>entry_tout</code>			<code>trk2data</code>	✓	
<code>capitalize</code>	✓	1	<code>events_on</code>			<code>trk3data</code>	✓	
<code>card_stat</code>			<code>invalcmdrsp</code>	✓	0	<code>visa_mac1</code>		
<code>chk_account</code>			<code>key_parity</code>			<code>visa_mac2</code>		
<code>chk_amount</code>			<code>lasterr</code>	✓		<code>visa_mac3</code>		
<code>chk_bankid</code>			<code>max_pin_len</code>			<code>wr_coer</code>		
<code>chk_data</code>			<code>msg1</code>			<code>wr_secure</code>		
<code>chk_format</code>			<code>msg2</code>			<code>xact_type</code>		

* = Depends on setting in the device.

MINIWEDGE MSR

File Name MINIWEDG.VXD

Part Number 30037340

Friendly Name(s) MiniWedge

Remarks When operating in the Windows Driver mode, the MiniWedge transmits data as ASCII characters instead of scan codes in order to reduce the transmission time. (A full 3-track card can be transmitted in about 0.5 second whereas in the non-driver mode it would take almost 4 seconds.) If this creates problems in certain hardware implementations, the *skip_ascii* and *dev_char_delay* parameters in the registry and/or INF file can be adjusted. The default setting for *dev_char_delay* is "01"; if this seems to be too fast, try setting this to "06". Additionally, the *skip_ascii* value can be set to true ("01") to transmit scan codes.

Commands Supported					
/cancel cmd	✓	/load_key n key		/reset	✓
/display [x]		/rawrcv	✓	/set prop val	✓
/echo string	✓	/rawsend x	✓	/ver	✓
/event n data		/rawxact x	✓	/write data	
/get prop	✓	/read [[x] y]	✓		

Properties Supported								
Property	Yes	Default	Property	Yes	Default	Property	Yes	Default
account_no			chk_mod10			msg3		
amount			chk_number			msg4		
applied_fmt	✓		chk_routing			offline_enc		
c_card_stat			chk_status			oper_tout		
c_cardwpin			chk_transit			pin_blk_fmt		
c_check		0	cmd_pending			pinfilldig		
c_events			dblpinentry			port_name	✓	
c_keypress			dev_status	✓		pwroffdelay		
c_keystring			dev_version	✓		s_down_tout		
c_magnetic	✓	1	enable_cmc7			track1ss	✓	
c_mechanics		0	enc_key			track2ss	✓	
c_pin			enc_key_sn			track3ss	✓	
c_smart		0	enc_mode			trivpinchk		
c_tracks	✓	*	entry_echo			trk_enable	✓	*
c_write		0	entry_len			trk1data	✓	
c_wr_secure			entry_tout			trk2data	✓	
capitalize	✓	1	events_on			trk3data	✓	
card_stat			invalcmdrsp	✓	0	visa_mac1		
chk_account			key_parity			visa_mac2		
chk_amount			lasterr	✓		visa_mac3		
chk_bankid			max_pin_len			wr_coer		
chk_data			msg1			wr_secure		
chk_format			msg2			xact_type		

* = Depends on setting in the device.

MICR+ CHECK READER & MSR

File Name MICRPLUS.VXD

Part Number 30037349

Friendly Name(s) MICR+

Remarks These devices may or may not have an MSR installed. If not installed, the driver may not properly indicate the `c_tracks` capability.

Commands Supported					
<code>/cancel cmd</code>	✓	<code>/load_key n key</code>		<code>/reset</code>	✓
<code>/display [x]</code>		<code>/rawrecv</code>	✓	<code>/set prop val</code>	✓
<code>/echo string</code>	✓	<code>/rawsend x</code>	✓	<code>/ver</code>	✓
<code>/event n data</code>		<code>/rawxact x</code>	✓	<code>/write data</code>	
<code>/get prop</code>	✓	<code>/read [[x] y]</code>	✓		

Properties Supported								
Property	Yes	Default	Property	Yes	Default	Property	Yes	Default
<code>account_no</code>			<code>chk_mod10</code>	✓		<code>msg3</code>		
<code>amount</code>			<code>chk_number</code>	✓		<code>msg4</code>		
<code>applied_fmt</code>	✓		<code>chk_routing</code>	✓		<code>offline_enc</code>		
<code>c_card_stat</code>			<code>chk_status</code>	✓		<code>oper_tout</code>		
<code>c_cardwpin</code>			<code>chk_transit</code>	✓		<code>pin_blk_fmt</code>		
<code>c_check</code>	✓	1	<code>cmd_pending</code>			<code>pinfilldig</code>		
<code>c_events</code>			<code>dblpinentry</code>			<code>port_name</code>	✓	
<code>c_keypress</code>			<code>dev_status</code>	✓		<code>pwroffdelay</code>		
<code>c_keystring</code>			<code>dev_version</code>	✓		<code>s_down_tout</code>		
<code>c_magnetic</code>	✓	1	<code>enable_cmc7</code>	✓	*	<code>track1ss</code>	✓	
<code>c_mechanics</code>		0	<code>enc_key</code>			<code>track2ss</code>	✓	
<code>c_pin</code>			<code>enc_key_sn</code>			<code>track3ss</code>	✓	
<code>c_smart</code>		0	<code>enc_mode</code>			<code>trivpinchk</code>		
<code>c_tracks</code>	✓	*	<code>entry_echo</code>			<code>trk_enable</code>	✓	*
<code>c_write</code>		0	<code>entry_len</code>			<code>trk1data</code>	✓	
<code>c_wr_secure</code>			<code>entry_tout</code>			<code>trk2data</code>	✓	
<code>capitalize</code>	✓	1	<code>events_on</code>			<code>trk3data</code>	✓	
<code>card_stat</code>			<code>invalcmdrsp</code>	✓	0	<code>visa_mac1</code>		
<code>chk_account</code>	✓		<code>key_parity</code>			<code>visa_mac2</code>		
<code>chk_amount</code>	✓		<code>lasterr</code>	✓		<code>visa_mac3</code>		
<code>chk_bankid</code>	✓		<code>max_pin_len</code>			<code>wr_coer</code>		
<code>chk_data</code>	✓		<code>msg1</code>			<code>wr_secure</code>		
<code>chk_format</code>	✓	**	<code>msg2</code>			<code>xact_type</code>		

* = Depends on setting in the device.

** = Depends on setting in INF file (default = 6500). See Section 1, "MICR Format Numbers" for more information.

MINI MICR CHECK READER & MSR

File Name MINIMICR.VXD

Part Number 30037344

Friendly Name(s) Mini MICR RS-232 & Mini MICR Wedge

Remarks These devices may or may not have an MSR installed. If not installed, the driver may not properly indicate the **c_tracks** capability.

Commands Supported					
/cancel cmd	✓	/load_key n key		/reset	✓
/display [x]		/rawrecv	✓	/set prop val	✓
/echo string	✓	/rawsend x	✓	/ver	✓
/event n data		/rawxact x	✓	/write data	
/get prop	✓	/read [[x] y]	✓		

Properties Supported								
Property	Yes	Default	Property	Yes	Default	Property	Yes	Default
account_no			chk_mod10	✓		msg3		
amount			chk_number	✓		msg4		
applied_fmt	✓		chk_routing	✓		offline_enc		
c_card_stat			chk_status	✓		oper_tout		
c_cardwpin			chk_transit	✓		pin_blk_fmt		
c_check	✓	1	cmd_pending			pinfilldig		
c_events			dblpinentry			port_name	✓	
c_keypress			dev_status	✓		pwroffdelay		
c_keystring			dev_version	✓		s_down_tout		
c_magnetic	✓	1	enable_cmc7	✓	*	track1ss	✓	
c_mechanics		0	enc_key			track2ss	✓	
c_pin			enc_key_sn			track3ss	✓	
c_smart		0	enc_mode			trivpinchk		
c_tracks	✓	*	entry_echo			trk_enable	✓	*
c_write		0	entry_len			trk1data	✓	
c_wr_secure			entry_tout			trk2data	✓	
capitalize	✓	1	events_on			trk3data	✓	
card_stat			invalcmdrsp	✓	0	visa_mac1		
chk_account	✓		key_parity			visa_mac2		
chk_amount	✓		lasterr	✓		visa_mac3		
chk_bankid	✓		max_pin_len			wr_coer		
chk_data	✓		msg1			wr_secure		
chk_format	✓	**	msg2			xact_type		

* = Depends on setting in the device.

** = Depends on setting in INF file (default = 6500). See "See Section 1, "MICR Format Numbers" for more information.

PORT-POWERED RS-232 SWIPE READER

File Name MTPPSWIP.VXD

Part Number 30037346

Friendly Name(s) Port-powered swipe reader

Remarks This driver supports all port-powered swipe readers.

Commands Supported					
<i>/cancel cmd</i>	✓	<i>/load_key n key</i>		<i>/reset</i>	✓
<i>/display [x]</i>		<i>/rawrcv</i>	✓	<i>/set prop val</i>	✓
<i>/echo string</i>	✓	<i>/rawsend x</i>	✓	<i>/ver</i>	✓
<i>/event n data</i>		<i>/rawxact x</i>	✓	<i>/write data</i>	
<i>/get prop</i>	✓	<i>/read [[x] y]</i>	✓		

Properties Supported								
Property	Yes	Default	Property	Yes	Default	Property	Yes	Default
account_no			chk_mod10			msg3		
amount			chk_number			msg4		
applied_fmt	✓		chk_routing			offline_enc		
c_card_stat			chk_status			oper_tout		
c_cardwpin			chk_transit			pin_blk_fmt		
c_check		0	cmd_pending			pinfilldig		
c_events			dblpinentry			port_name	✓	
c_keypress			dev_status	✓		pwroffdelay		
c_keystring			dev_version	✓		s_down_tout		
c_magnetic	✓	1	enable_cmc7			track1ss	✓	
c_mechanics		0	enc_key			track2ss	✓	
c_pin			enc_key_sn			track3ss	✓	
c_smart		0	enc_mode			trivpinchk		
c_tracks	✓	*	entry_echo			trk_enable	✓	*
c_write		0	entry_len			trk1data	✓	
c_wr_secure			entry_tout			trk2data	✓	
capitalize	✓	1	events_on			trk3data	✓	
card_stat			invalcmdrsp	✓	0	visa_mac1		
chk_account			key_parity			visa_mac2		
chk_amount			lasterr	✓		visa_mac3		
chk_bankid			max_pin_len			wr_coer		
chk_data			msg1			wr_secure		
chk_format			msg2			xact_type		

* = Depends on setting in the device.

PORT-POWERED RS-232 INSERTION READER

File Name MTPPINSR.VXD

Part Number 30037339

Friendly Name(s) Port-powered insert reader

Remarks If **events_on** is enabled, the driver will send **/event 1 M** when the card is inserted. It is suggested that events be disabled (**/set events_on 0**) before the data is read to prevent the removal event from being included at the end of card data. If a card has already been inserted when the driver is opened, there will not be any notification when **events_on** is enabled. Consequently, it is recommended that **/get card_stat** be issued immediately after opening the driver to see if a card is blocking the sensor.

Commands Supported					
<i>/cancel cmd</i>	✓	<i>/load_key n key</i>		<i>/reset</i>	✓
<i>/display [x]</i>		<i>/rawrcv</i>	✓	<i>/set prop val</i>	✓
<i>/echo string</i>	✓	<i>/rawsend x</i>	✓	<i>/ver</i>	✓
<i>/event n data</i>	✓	<i>/rawxact x</i>	✓	<i>/write data</i>	
<i>/get prop</i>	✓	<i>/read [[x] y]</i>	✓		

Properties Supported								
Property	Yes	Default	Property	Yes	Default	Property	Yes	Default
account_no			chk_mod10			msg3		
amount			chk_number			msg4		
applied_fmt	✓		chk_routing			offline_enc		
c_card_stat	✓	1	chk_status			oper_tout		
c_cardwpin			chk_transit			pin_blk_fmt		
c_check		0	cmd_pending			pinfilldig		
c_events	✓	1	dblpinentry			port_name	✓	
c_keypress			dev_status	✓		pwroffdelay		
c_keystring			dev_version	✓		s_down_tout		
c_magnetic	✓	1	enable_cmc7			track1ss	✓	
c_mechanics		0	enc_key			track2ss	✓	
c_pin			enc_key_sn			track3ss	✓	
c_smart		0	enc_mode			trivpinchk		
c_tracks	✓	110	entry_echo			trk_enable	✓	110
c_write		0	entry_len			trk1data	✓	
c_wr_secure			entry_tout			trk2data	✓	
capitalize	✓	1	events_on	✓	0	trk3data	✓	
card_stat	✓		invalcmdrsp	✓	0	visa_mac1		
chk_account			key_parity			visa_mac2		
chk_amount			lasterr	✓		visa_mac3		
chk_bankid			max_pin_len			wr_coer		
chk_data			msg1			wr_secure		
chk_format			msg2			xact_type		

* = Depends on setting in the device.

MT-85 LOCO ENCODER

File Name MT85.VXD

Part Number 30037337

Friendly Name(s) MT-85

Remarks The driver attempts to connect to the device by automatically scanning all connection modes.

Commands Supported					
<i>/cancel cmd</i>	✓	<i>/load_key n key</i>		<i>/reset</i>	✓
<i>/display [x]</i>		<i>/rawrecv</i>	✓	<i>/set prop val</i>	✓
<i>/echo string</i>	✓	<i>/rawsend x</i>	✓	<i>/ver</i>	✓
<i>/event n data</i>		<i>/rawxact x</i>	✓	<i>/write data</i>	✓
<i>/get prop</i>	✓	<i>/read [[x] y]</i>	✓		

Properties Supported								
Property	Yes	Default	Property	Yes	Default	Property	Yes	Default
account_no			chk_mod10			msg3		
amount			chk_number			msg4		
applied_fmt	✓		chk_routing			offline_enc		
c_card_stat			chk_status			oper_tout		
c_cardwpin		0	chk_transit			pin_blk_fmt		
c_check		0	cmd_pending	✓		pinfilldig		
c_events			dblpinentry			port_name	✓	
c_keypress		0	dev_status	✓		pwroffdelay		
c_keystring		0	dev_version	✓		s_down_tout		
c_magnetic	✓	1	enable_cmc7			track1ss	✓	
c_mechanics		0	enc_key			track2ss	✓	
c_pin		0	enc_key_sn			track3ss	✓	
c_smart		0	enc_mode			trivpinchk		
c_tracks	✓	*	entry_echo			trk_enable	✓	*
c_write	✓	2	entry_len			trk1data	✓	
c_wr_secure	✓	0	entry_tout			trk2data	✓	
capitalize	✓	1	events_on			trk3data	✓	
card_stat			invalcmdrsp	✓	0	visa_mac1		
chk_account			key_parity			visa_mac2		
chk_amount			lasterr	✓		visa_mac3		
chk_bankid			max_pin_len			wr_coer	✓	1
chk_data			msg1			wr_secure		
chk_format			msg2			xact_type		

* = Depends on setting in the device.

MT-95 HICO ENCODER

File Name MT95.VXD

Part Number

30037347

Friendly Name(s) MT-95

Remarks

Commands Supported					
/cancel cmd	✓	/load_key n key		/reset	✓
/display [x]		/rawrecv	✓	/set prop val	✓
/echo string	✓	/rawsend x	✓	/ver	✓
/event n data		/rawxact x	✓	/write data	✓
/get prop	✓	/read [[x] y]	✓		

Properties Supported								
Property	Yes	Default	Property	Yes	Default	Property	Yes	Default
account_no			chk_mod10			msg3		
amount			chk_number			msg4		
applied_fmt	✓		chk_routing			offline_enc	✓	*
c_card_stat			chk_status			oper_tout		
c_cardwpin			chk_transit			pin_blk_fmt		
c_check		0	cmd_pending	✓		pinfilldig		
c_events			dblpinentry			port_name	✓	
c_keypress			dev_status	✓		pwroffdelay		
c_keystring			dev_version	✓		s_down_tout		
c_magnetic	✓	1	enable_cmc7			track1ss	✓	
c_mechanics		0	enc_key			track2ss	✓	
c_pin			enc_key_sn			track3ss	✓	
c_smart		0	enc_mode			trivpinchk		
c_tracks	✓	111	entry_echo			trk_enable	✓	*
c_write	✓	1	entry_len			trk1data	✓	
c_wr_secure	✓	1	entry_tout			trk2data	✓	
capitalize	✓	1	events_on			trk3data	✓	
card_stat			invalcmdrsp	✓	0	visa_mac1		
chk_account			key_parity			visa_mac2		
chk_amount			lasterr	✓		visa_mac3		
chk_bankid			max_pin_len			wr_coer	✓	*
chk_data			msg1			wr_secure	✓	*
chk_format			msg2			xact_type		

* = Depends on setting in the device.

INDEX

A

Access to the device	82
account_no	87
Action properties	79
Adding a Keyboard Device (WNT)	142
Adding a Serial Device (WNT).....	143
Adding an 'IntelliPIN MICR Aux' Device (WNT)	143
Adding Another Device Driver (W95/98)	131
Adding New Devices (WNT).....	45
Adding the First Device Driver (W95/98)	131
amount	87
any - Read Argument	99
Asynchronous devices	77
Automatic settings	81

B

Baud rate	148
-----------------	-----

C

c_card_stat	87
c_cardwpin	87
c_check	87
c_events	87
c_keypress	87
c_keystring	87
c_magnetic	87
c_mechanics	87
c_pin	87
c_smart	87
c_tracks	87
c_wr_secure	88
c_write	88
C++ Example	121
Cancel Command	92
Capability properties	79, 87
capitalize	88
Card Read Arguments	99
Card Sensor Status (card_stat)	88
card_stat	88
card_w_pin - Read Argument	99
check - Read Argument	99

Checksum	77
chk_account	88
chk_amount	88
chk_bankid	88
chk_data	88
chk_format	88
chk_mod10	88
chk_number	88
chk_or_card - Read Argument	100
chk_routing	88
chk_status	88
chk_transit	88
Close the device	82
cmd_pending	88
Com Port	133, 134, 143, 148
Command List Summary	151
Commands	79, 151
Communication protocol	77
Configuration Examples of NT Drivers ..	147
Configuration properties	79
Control characters	77
Control language	78
Controlling Devices, Problems with	77

D

Data Bits	134
Data Format	91
Data Parsing	148
Data Parsing Assumptions	105
Data Parsing Description	106
Data Parsing Goals	105
Data Parsing Language Format	107
Data Parsing, Magnetic Card	105
Data size	148
Data streams communication	77
dblpinentry	88
Default Formats for Data Parsing	111
Delphi	78
dev_char_delay	158
dev_status	88
dev_version	88
Device capabilities,query	81

Device control language.....	78
Device Driver Summaries.....	155
Device, close the.....	82
Device, interacting with.....	83
Device, methods of accessing.....	82
Device, obtaining access to.....	82
Device, open.....	81
Device, prepare for work.....	81
Device, releasing access to.....	84
Device, use the.....	81
Device-specific commands.....	80
Device-specific properties.....	79
Display Command.....	93
Displaying Configuration Information (WNT).....	145
Double PIN Entry (dblpinentry).....	88
Driver benefits.....	78

E

Echo Command.....	93
enable_cmc7.....	88
enc_key.....	89
enc_key_sn.....	89
enc_mode.....	89
Encode Coercivity Mode (wr_coer).....	90
entry_echo.....	89
entry_len.....	89
entry_tout.....	89
Error processing.....	84
Errors.....	84
Event Response.....	94
events_on.....	89
Example Applications.....	105–128

F

File properties.....	9
Format Name for Data Parsing.....	31
Format Numbers, MICR.....	10
Format Rules for Data Parsing.....	31
Format Template for Data Parsing.....	31
Friendly Name.....	58, 72
Friendly names of devices.....	54, 61, 63, 80–88

G

Generic Driver.....	85, 137, 139
Get Command.....	94

I

Idle message.....	93
Installation.....	86
Installation and Setup.....	129–150
Installing Device Drivers (W2000/XP).....	139
Installing Device Drivers (W95/98).....	130
Installing Device Drivers (WNT).....	137
IntelliPIN PINPad & MSR.....	156
Interacting with the device.....	83
Interactive commands.....	80
Interface, synchronous.....	78
invalcmdrsp.....	89
Invalid Command Response (invalcmdrsp)	89

K

key_parity.....	89
key_press - Read Argument.....	100
key_string - Read Argument.....	100
Keyboard port.....	78

L

Language Overview.....	79
lasterr.....	89
Load_key Command.....	95

M

Mag Wedge Swipe Reader.....	157
Mag-Tek Device Drivers for Windows.....	77
max_pin_len.....	89
Methods of accessing the device.....	82
MICR Format Numbers.....	86
MICR+ Check Reader & MSR.....	159
Mini MICR Check Reader & MSR.....	160
MiniWedge MSR.....	158
Modifying a Device Driver's Settings (W95/98).....	133
msg1-4.....	89
MT-85 LoCo Encoder.....	163
MT-95 HiCo Encoder.....	164

MTCFG Utility (WNT), Using 144
MTD (Mag-Tek Drivers) 77

N

Non-interactive commands 80
Notation Conventions 92

O

offline_enc 90
Open a device 81, 83
oper_tout 90
Operational Timeout (oper_tout) 90

P

Packets communication 77
Parallel port 78
Parity 134, 148
Parsing 105–114
Parsing, Data 105
Part Number, Driver 85
pin - Read Argument 101
pin_blk_fmt 90
pinfilldig 90
Port Name 134, 148
port_name 90
Port-Powered RS-232 Insertion Reader ... 162
Port-Powered RS-232 Swipe Reader 161
Power Builder Example 126
Power Off Time Delay (pwoffdelay) 90
Prepare the device for work 81
Problems with Controlling Devices 77
Programming Hints, Keyboard Wedge ... 115
Properties 79, 87–90
Properties, action 79
Properties, capability 79
Properties, configuration 79
Properties, device specific 79
Property Sheet, Device Configuration 132
Protocol, communication 77
pwoffdelay 90

Q

Query device capabilities 81

R

Raw commands 78, 80
Rawrecv Command 96
Rawsend Command 97
Rawxact Command 97
Read Arguments 99
Read Command 98
Read response 99
Read status 98, 99
Releasing access to the device 84
Removing a Device (WNT/2000/XP) 149
Removing the Drivers (W95/98) 135
Removing the Drivers (WNT) 138
Reset Command 102
Responses 91

S

s_down_tout 90
Serial port 78
Set Command 102
Shutdown Timeout (s_down_tout) 90
skip_ascii 158
Special Commands 85
Start Sentinel 90
Status Codes 153
Status, Read 98, 99
Stop bits 134, 148
Synchronous interface 78

T

Transaction type (xact_type) 90
Trivial PIN Check (trivpinchk) 90
trivpinchk 90
trk_enable 90
trk1data 90
trk2data 90
trk3data 90
Typical operation 81

U

Uninstalling the Drivers (W2000/XP) 141
Uninstalling the Drivers (W95/98/ME) ... 135
Uninstalling the Drivers (WNT) 138
Updating an Installed Device Driver
(W95/98) 132

MagTek Device Drivers for Windows

Use Port..... 143, 148

Use the device 81

V

Ver Command 102

Version, Driver..... 85

Viewing the List of Configured Devices

(WNT)..... 144

Virtual device 81

visa_mac1-3 90

Visual Basic..... 78

Visual Basic Example 115

W

wr_coer..... 90

wr_secure 90

Write Command 103

X

xact_type 90