

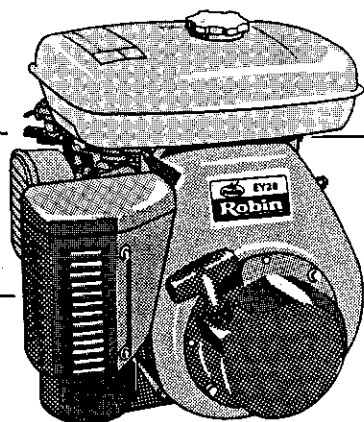

MODEL

**EY15D/15B/15-2B**  
**EY20D/20B**  
**EY28D/28B**

**INSTRUCTIONS FOR USE**



ISSUE EMD-EU0957

2ZZ9020048

**Robin Engines**



**WARNING :**



The engine exhaust from this product contains chemicals known to the State of California to cause cancer, birth defects or other reproductive harm.

# FOREWORD

*Thank you very much for purchasing a **ROBIN ENGINE.***



*Your **ROBIN ENGINE** can supply the power to operate various sorts of machines and equipment.*

*Please take a moment to familiarize yourself with the proper operation and maintenance procedures in order to maximize the safe and efficient use of this product.*

*Due to constant efforts to improve our products, certain procedures and specifications are subjected to change without notice.*

**SPEC. NO. E Y**

:	:	:	:	:	:	:	:	:	:
---	---	---	---	---	---	---	---	---	---

*When ordering spare parts, always give us the **MODEL, SPECIFICATION and SERIAL NUMBER** of your engine.*







*Please fill in the following blanks after checking the specification number on your engine.*

# CONTENTS

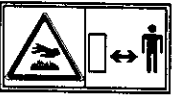
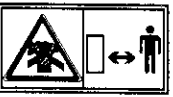
1. SAFETY PRECAUTIONS .....	1
2. COMPONENTS .....	4
3. PRE-OPERATION CHECKS .....	5
4. ELECTRIC STARTER MODELS .....	6
5. OPERATING YOUR ENGINE .....	8
6. EASY TROUBLESHOOTING .....	12
7. OIL SENSOR INSTRUCTIONS (OPTIONAL) .....	14
8. MAINTENANCE SCHEDULE .....	15
9. "HOW-TO" MAINTENANCE .....	16
10. PREPARATIONS FOR STORAGE .....	19
11. SPECIFICATIONS .....	20

## FOREWORD

### SYMBOLS

		<i>Read the owner's manual.</i>	
		<i>Stay clear of the hot surface.</i>	
		<i>Exhaust gas is poisonous. Do not operate in an unventilated room.</i>	
		<i>Stop the engine before refueling.</i>	
		<i>Fire, open light and smoking prohibited.</i>	
	<i>On (Run)</i>	+	<i>Plus; Positive polarity</i>
○	<i>Off (Stop)</i>		<i>Battery</i>
	<i>Engine oil</i>		<i>Engine start (Electric start)</i>
	<i>Add oil</i>		

# 1. SAFETY PRECAUTIONS

Please make sure you review each precaution carefully.

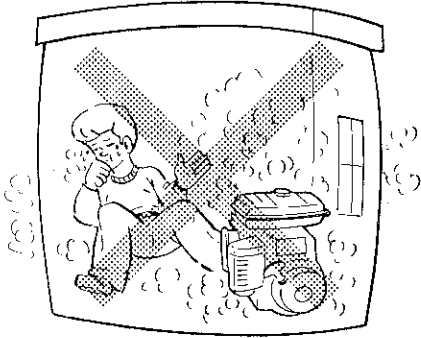

## EXHAUST PRECAUTIONS

- Never inhale exhaust gasses. They contain carbon monoxide, a colorless, odorless and extremely dangerous gas which can cause unconsciousness or death.
- Never operate the engine indoors or in a poorly ventilated area, such as tunnel, cave, etc.
- Exercise extreme care when operating the engine near people or animals.
- Keep the exhaust pipe free of foreign objects.

## REFUELING PRECAUTIONS

- Be sure to stop the engine prior to refueling.
- Do not overfill the fuel tank.
- If fuel is spilt, wipe it away carefully and wait until the fuel has dried before starting the engine.
- After refueling, make sure that the fuel cap is secured to prevent spillage.

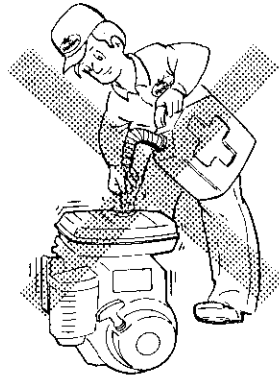

## FIRE PREVENTION

- Do not operate while smoking or near an open flame.
- Do not use around dry brush, twigs, cloth rags, or other flammable materials.
- Keep the engine at least 3 feet (1 meter) away from buildings or other structures.
- Keep the engine away from flammables and other hazardous materials (trash, rags, lubricants, explosives).

## 1. SAFETY PRECAUTIONS

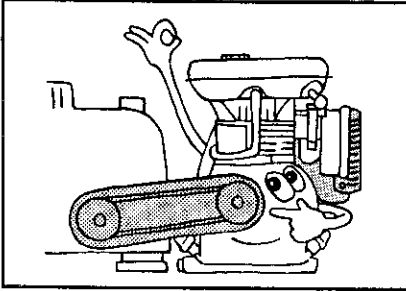

### PROTECTIVE COVER

- Place the protective covers over the rotating parts.

If rotating parts such as the drive shaft, pulley, belt, etc. are left exposed, they are potentially hazardous.

To prevent injury, equip them with protective covers or shrouds.

- Be careful of hot parts.

The muffler and other engine parts become very hot while the engine is running or just after it has stopped.

Operate the engine in a safe area and keep children away from the running engine.

- Never make adjustments on the machinery while it is connected to the engine, without first removing the ignition cable from the spark plug.

Turning over the machinery by hand during adjusting or cleaning might start the engine, and machinery with it, causing serious injury to the operator.

- Never run the engine with governor disconnected, or operate at speeds in excess of 3600 rpm load.

### SURROUNDINGS

- Operate the engine on a stable, level surface free of small rocks, loose gravel, etc.

**Operate the engine on a level surface.**

If the engine is tilted, fuel spillage may result.

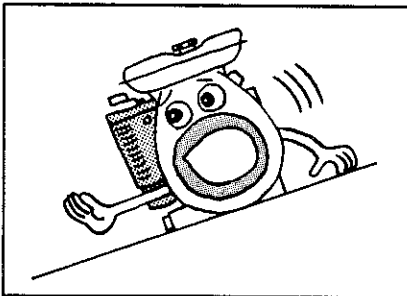

### NOTE

Operating the engine at a steep incline may cause seizure due to improper lubrication even with a maximum oil level.

## 1. SAFETY PRECAUTIONS



- **Be careful of fuel spillage when transporting the engine.**

Tighten the fuel tank cap securely and close the fuel strainer cock before transport.

- **Do not move the engine while in operation when it has been removed from the equipment.**

- **Keep the unit dry (do not operate it in rainy conditions).**

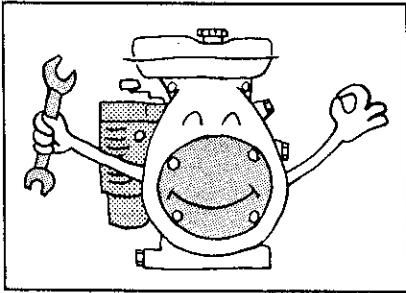

### PRE-OPERATION CHECKS

- Carefully check fuel pipes and joints for looseness and fuel leakage. Leaked fuel creates a potentially dangerous situation.

- Check bolts and nuts for looseness. A loose bolt or nut may cause serious engine trouble.

- Check the engine oil and refill if necessary.

- Check the fuel level and refill if necessary.

- Take care not to overfill the tank.

- Wear snug fitting working clothes when operating the engine.

Loose aprons, towels, belt, etc., may be caught in the engine or drive train, causing a dangerous situation.



# 2. COMPONENTS

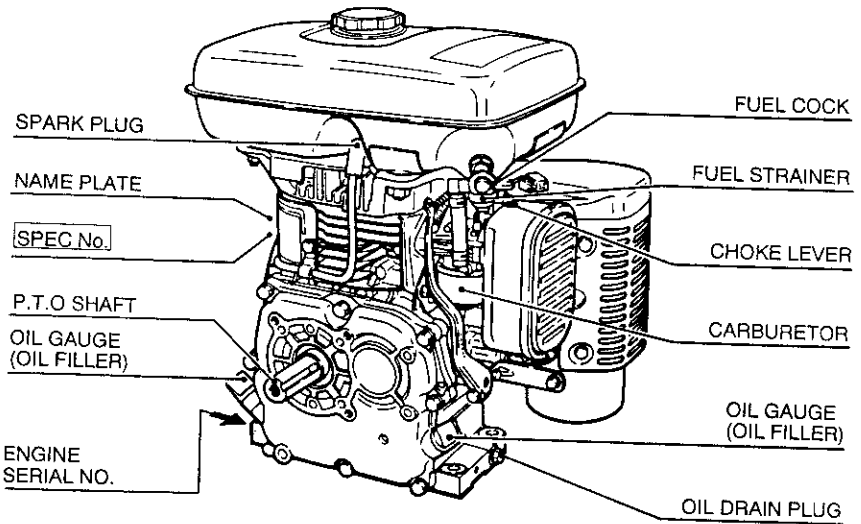
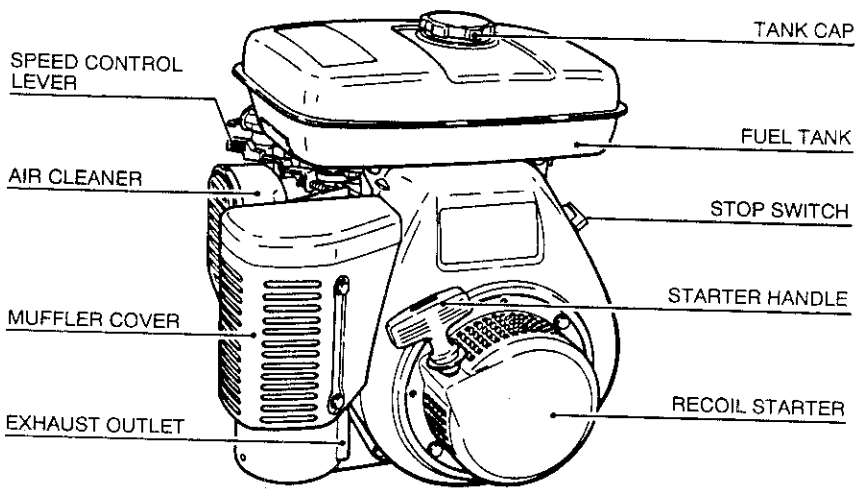

# 3. PRE-OPERATION CHECKS

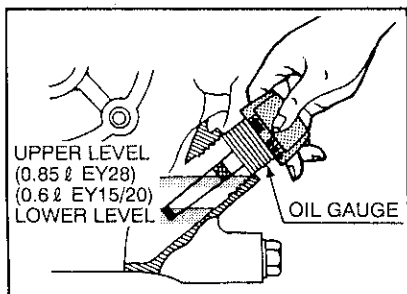

Single grade	5W
	10W
	20W
	# 20
	# 30
Multi-grade	10W-30
	10W-40
Ambient temperature	-20 -10 0 10 20 30 40°C -4 14 32 50 68 86 104°F



## CHECK ENGINE OIL

Before checking or refilling engine oil, be sure the engine is located on a stable, level surface and stopped.

- Remove the oil gauge cap.
- If the oil level is below the lower level line on the dipstick, refill with the proper oil (see table) to edge of the oil filler.
- Change the oil if it is contaminated. (See page 15 Maintenance Schedule.)
- Use class SC (API classification) or higher grade oil.
- If multi-grade oil is employed, oil consumption tends to increase when the ambient temperature is high.

## CHECK FUEL

### ⚠ CAUTION

Do not refuel while smoking, near an open flame or other potential hazards.

- Stop the engine and open the cap.
- Use unleaded gasoline only.
- Close the fuel cock before filling the fuel tank.
- When filling the fuel tank, always use the fuel filter.
- Wipe off any spilled fuel before starting the engine.

# 4. ELECTRIC STARTER MODELS



## PARTS TO BE PREPARED

In case your engine has the electric starter, please prepare the following accessories :

- Use battery rated at 12V-24AH or larger.
- Use a proper cable and ground wire to connect battery.

## BATTERY

CABLE LENGTH	CABLE DIA.	WIRE GAUGE		
		AWG(BS) BWG	SAE	JIS
Less than 1.5m	7.3mm	1	6	AV15
1.5m to 2.5m	8.5mm	0	4	AV20
2.5m to 4m	10.8mm	3/0	2	AV30

For GROUND WIRE, use a flat braided wire of 0.03 sq. in. or larger sectional area. (SAE GAUGE #4)

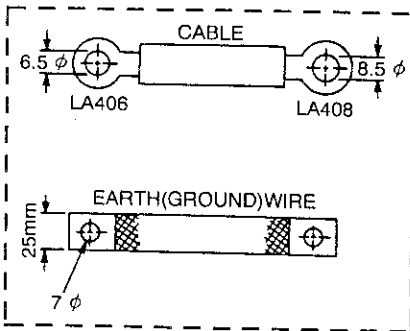

## WIRING

1. Connect the positive terminal on the starting motor to the positive terminal on the battery.

Do not connect the opposite way.

2. Connect the negative terminal on the battery to the engine body or the machine body with the earth wire.

3. When the key switch is mounted on the machine, fix its drain hole downward.

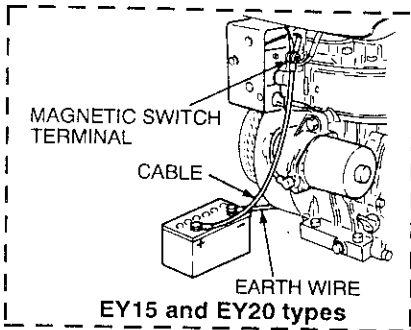

## NOTE

Tighten bolts and nuts on terminals securely so they will not be loosened by vibration.

## 4. ELECTRIC STARTER MODELS

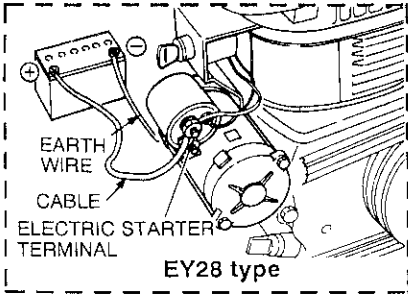

**WIRING DIAGRAM (for EY15 and EY20 types)**

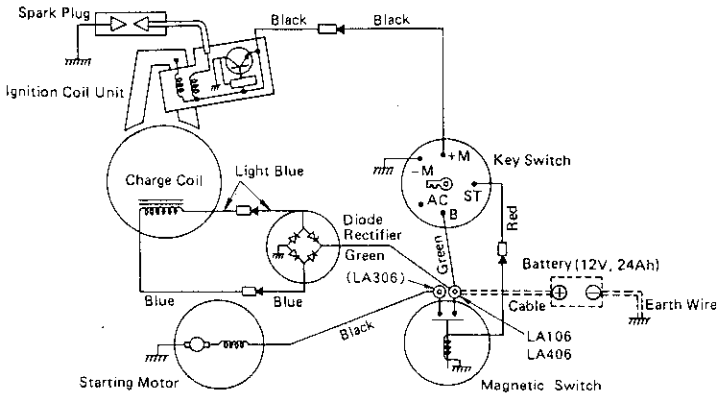

**WIRING DIAGRAM (for EY28 type)**

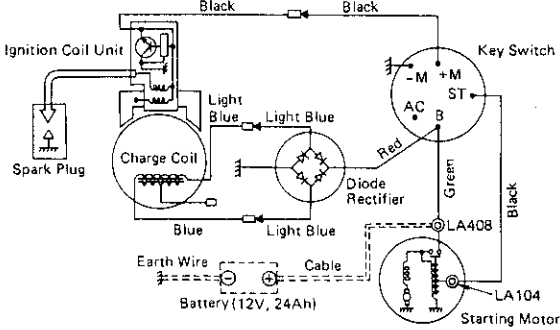

# 5. OPERATING YOUR ENGINE

## STARTING

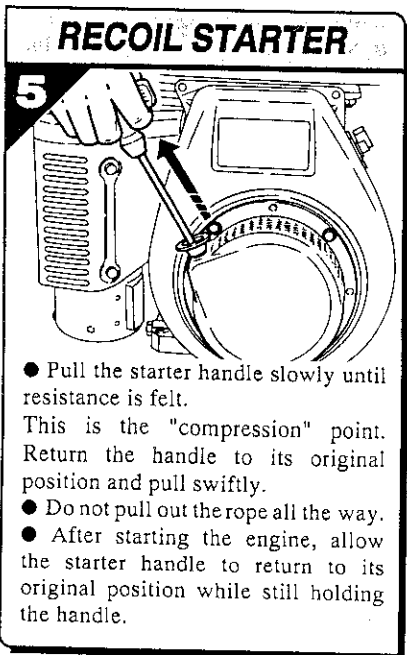
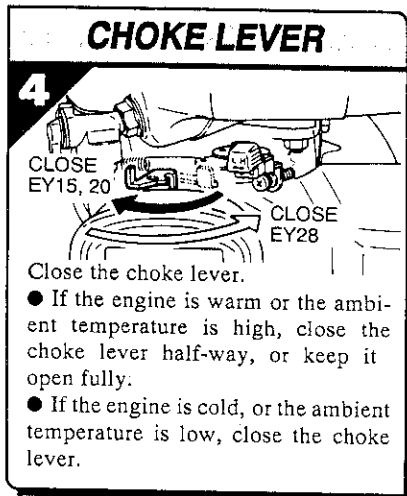
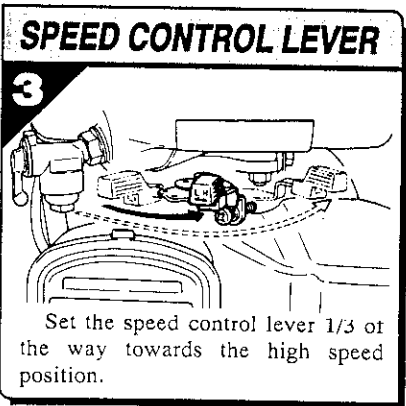
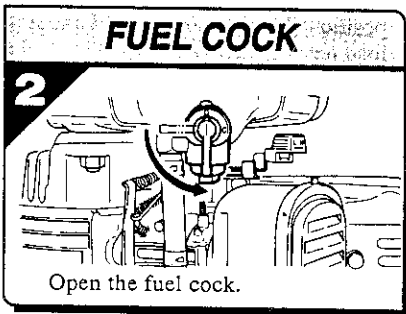
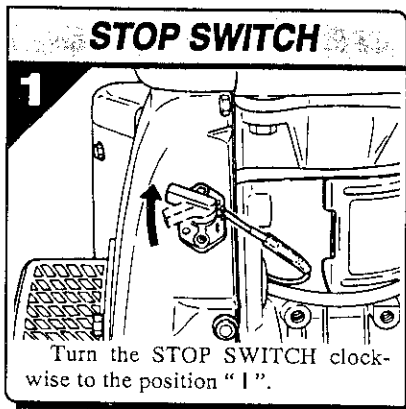

## 5. OPERATING YOUR ENGINE

### RUNNING

#### KEY SWITCH

- 5** In case you have an engine with electric starter.



Insert the key into the key slot and set it at the RUN position.

Turning it to the right (START position), starts the engine.

● Do not operate the electric starter continuously for more than 5 seconds, even if the engine does not start.

● Set the key to the RUN position and take a rest for 10 seconds try starting the engine again.

● Never turn the key switch to the START position while engine is running.

#### CHOKE LEVER

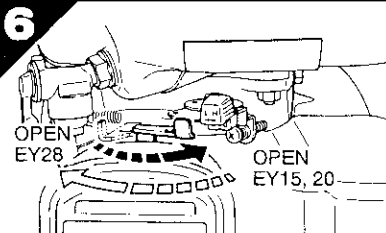

After starting the engine, gradually open choke by turning the choke lever and finally keep it open fully.

Do not fully open the choke lever immediately when the engine is cold or the ambient temperature is low, because the engine may stop.

#### SPEED CONTROL LEVER

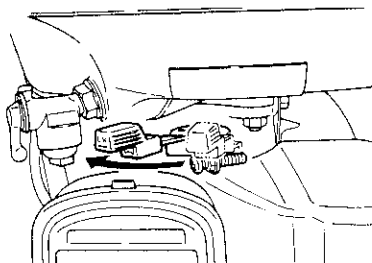

After the engine starts, set the speed control lever at the low speed position (L) and warm it up without load for a few minutes.

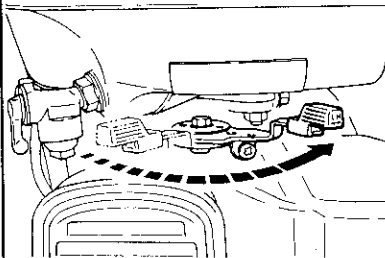

Gradually move the speed control lever toward the high speed position (H) and set it at the required engine speed.

#### NOTE :

Whenever high speed operation is not required, slow the engine down (idle) by moving the speed control lever to save fuel and extend engine life.

## 5. OPERATING YOUR ENGINE

### STOPPING

#### SPEED CONTROL LEVER

1

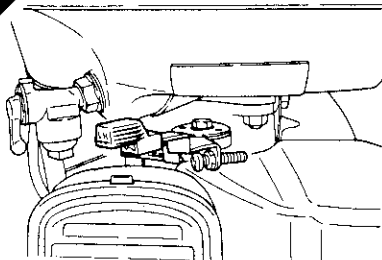

Set the speed control lever at the low speed position(L) and allow the engine to run at low speed for 2 or 3 minutes before stopping.

#### STOP SWITCH

2

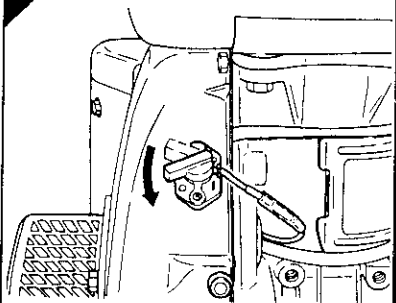

Turn the STOP SWITCH counterclockwise to the position "O".

#### KEY SWITCH

(In case your engine has an electric starter)

2



Set the key switch to STOP position.

#### FUEL COCK

3

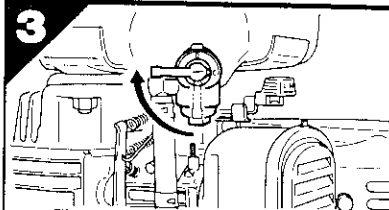

Close the fuel cock.

#### RECOIL STARTER

4

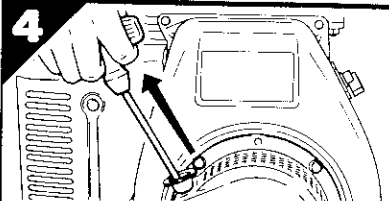

Pull the starter handle slowly and return the handle to its original position when resistance is felt.

#### NOTE :

The above operation is necessary to prevent outside moist air from intruding into the combustion chamber.

## 5. OPERATING YOUR ENGINE

---

### **STOPPING ENGINE WITH THE FUEL COCK**

Close the fuel cock and wait for a while until the engine stops.

Avoid to let the fuel remain in the carburetor over long periods, or the passages of the carburetor may become clogged with impurities, and malfunctions may result.

If your engine has an electric starter, set the key switch to the STOP position after stopping the engine.



# 6. EASY TROUBLESHOOTING



## WHEN ENGINE WILL NOT START :

- Perform the following checks before you take the engine to your Robin dealer.
- If you still have trouble after completing the checks, take the engine to your nearest Robin dealer.

### Is there enough compression ?

1. Pull the starter handle slowly and check if resistance is felt.
2. If little force is required to pull the starter handle, check if the spark plug is tightened firmly.
3. If the spark plug is loose, tighten it.

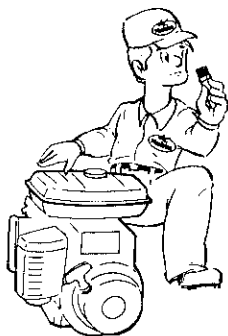

### Is the spark plug wet with gasoline ?

1. Choke (close choke lever) and pull the starter handle five or six times. Remove the plug and check if its electrode is wet.

If the electrode is wet, fuel is well supplied to your engine.

2. When the electrode is dry, check where the fuel stops. (Check the fuel intake of the carburetor and fuel strainer intake.)
3. In case the engine does not start with well supplied fuel, try to use fresh fuel.



Is there a strong spark across the electrode ?

**⚠ WARNING**

Wipe out spilled fuel carefully before testing.  
Place spark plug as far away from spark plug hole as possible.  
Do not hold spark plug by hand while pulling recoil starter.

1. Remove the plug and connect it to the plug cap.  
Pull the starter handle while grounding spark plug against engine body.
  2. Try with a new plug if the spark is weak or there is no spark.
  3. The ignition system is faulty if there is no spark with a new plug.
- Take your engine to your nearest Robin dealer.

**NOTE**

Engine with the oil sensor will stop automatically when the oil level falls below the prescribed limit.  
The engine can not be started unless the oil level is raised above the prescribed limit.

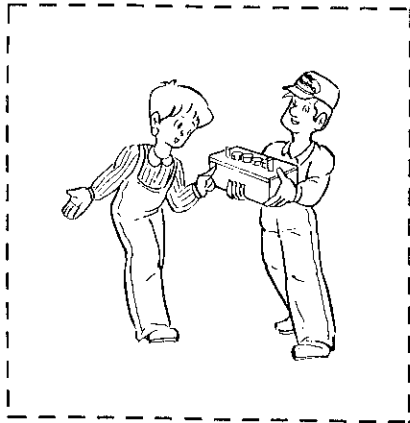

**Is your battery well charged ?**

If your battery for the electric starter is overly discharged, your engine will not start.  
Consult your nearest dealer or service shop.

# 7. OIL SENSOR INSTRUCTIONS (OPTIONAL)

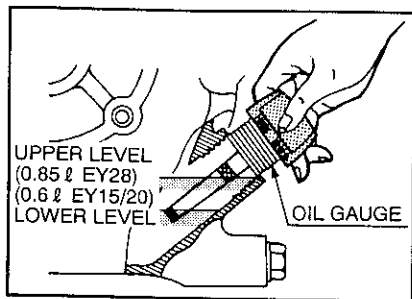

## Is your oil sensor OK ?

The engine will stop automatically when the oil level falls below the safety limit.

The engine cannot be started unless the level is raised above the prescribed limit.

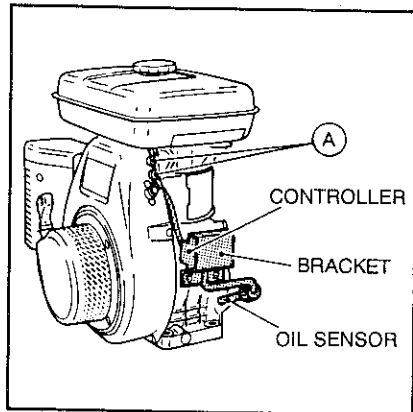

## RESTARTING

- Fill the engine with oil up to the proper level.
- As for restarting and operating the engine, refer to "Section 5, OPERATING YOUR ENGINE" on page 8.
- Check the wire connector (A) from the engine.

It must be connected securely to the wire from oil sensor unit.

### NOTE

Do not remove the oil sensor from the engine when checking the oil level and refilling.

When selecting the engine oil, refer to the chart on page 5.

# 8. MAINTENANCE SCHEDULE

## DAILY INSPECTION

Before running the engine, check the following service items.

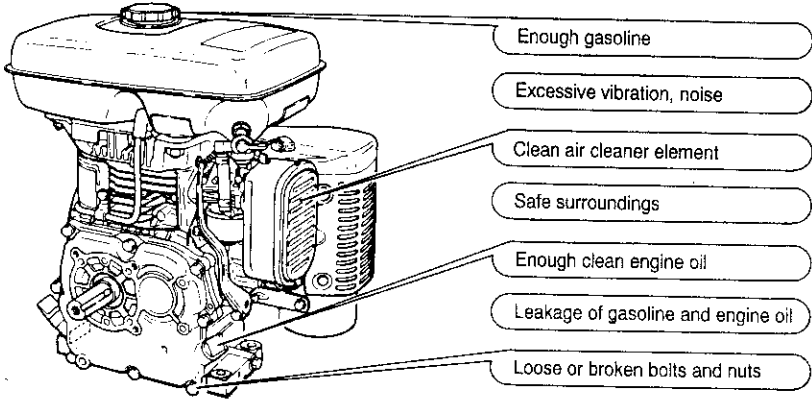

## PERIODIC INSPECTION

Periodic maintenance is vital to the safe and efficient operation of your engine.

Check the table below for periodic maintenance intervals.

The following chart is based on the normal engine operation schedule.

	8 hours (daily)	50 hours (weekly)	200 hours (Monthly)	500 hours	1000 hours
<b>CLEAN ENGINE AND CHECK BOLTS &amp; NUTS</b>	● (Daily)				
<b>CHECK AND REFILL ENGINE OIL</b>	● (Refill daily upper limit.)				
<b>CHANGE ENGINE OIL</b>	(Initial 20 hours)	●			
<b>CLEAN SPARK PLUG</b>		●			
<b>CLEAN AIR CLEANER</b>		●			
<b>CLEAN FUEL STRAINER</b>			●		
<b>CLEAN AND ADJUST SPARK PLUG GAP</b>			●		
<b>CLEAN AND ADJUST CARBURETOR</b>				●	
<b>CLEAN CYLINDER HEAD</b>				●	
<b>ADJUST VALVE CLEARANCE</b>				●	
<b>OVERHAUL ENGINE IF NECESSARY</b>					●

# 9. "HOW-TO" MAINTENANCE

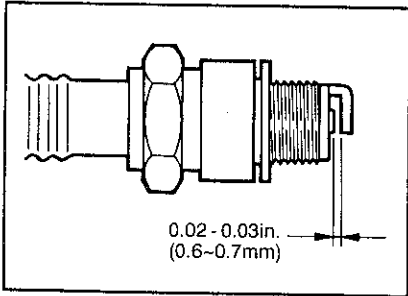

## INSPECTING THE SPARK PLUG

- Clean off carbon deposits on the plug electrode using a plug cleaner or wire brush.
- Check electrode gap.  
Adjust gap 0.6 mm to 0.7 mm (0.02 inch.- 0.03 inch.)
- Use a proper spark plug :

EY15, 20 : B-6HS (NGK)  
              L86C (CHAMPION)  
EY28 : BP-6HS (NGK)  
              L87Y (CHAMPION)

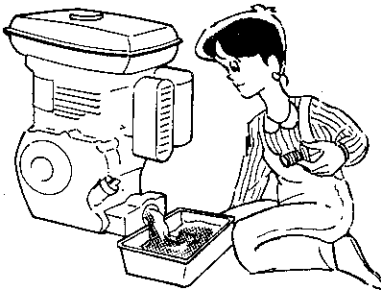

## ENGINE OIL CHANGE



### WARNING

Make sure the fuel cap is tightly secured to avoid spillage.

- Initial oil change  
..... After 20 hours of operation
- Thereafter  
..... Every 50 hours of operation



1. When changing oil, stop the engine and loosen the drain plug.
2. Re-install the drain plug before refilling oil.
3. Refer to the recommended oil table on page 5.
4. Always use the best grade and clean oil. Contaminated oil, poor quality oil and shortage of oil cause damage to engine or shorten the engine life.

### OIL CAPACITY:

EY15 and 20 type .. 0.6 ℓ  
EY28 type ..... 0.85 ℓ

## 9. "HOW-TO" MAINTENANCE

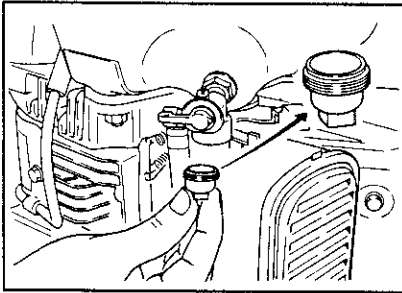

### CLEANING FUEL STRAINER

- Check for water or contaminants in the fuel strainer.
  - To remove water and dirt, close the fuel cock and remove the strainer cup.
  - After removing dirt and water, wash the strainer cup with gasoline.
- Reinstall securely to prevent leakage.

### CLEANING AIR CLEANER

Dirty air cleaner element will cause starting difficulty, power loss, engine malfunctions, and shorten engine life extremely.

Keep the air cleaner element clean.

#### ● Urethane Foam Element

Remove the element and wash it in kerosene or diesel fuel. Then saturate it in a mixture of 3 parts kerosene and 1 part engine oil. Squeeze the element to remove the mixture and install it in the air cleaner.

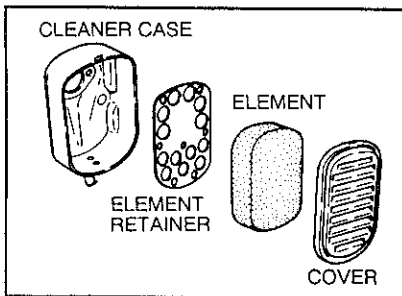

#### ● Urethane Foam Dual Structure

1. Clean the urethane foam in the same way as described above.
2. Wash the element in kerosene or diesel fuel. With the kerosene or diesel fuel still dripping off, saturate it in a mixture of 3 parts kerosene or diesel fuel and 1 part engine oil, wring the element to remove the mixture and install.

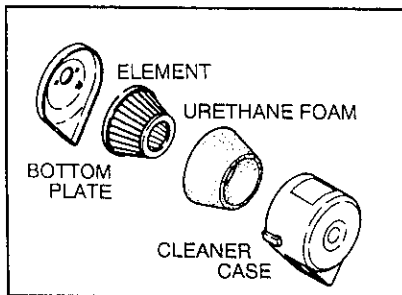

- If an oil bath or special air cleaner with pre-cleaner is used, clean the oil pan, fill oil to the required level or clean the dust pan.

## 9. "HOW-TO" MAINTENANCE

### CHECKING BOLTS, NUTS AND SCREWS

Retighten loose bolts and nuts.  
Check for fuel and oil leaks.  
Replace damaged parts with new ones.  
Keep safety in your mind.

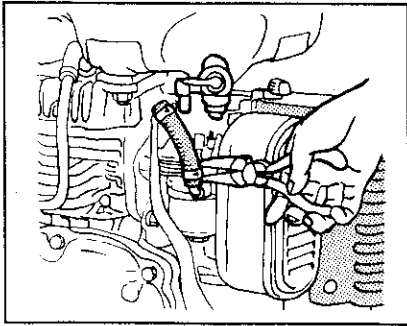
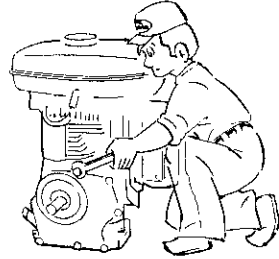

### FUEL PIPE REPLACEMENT

Replace the fuel pipe every 2 years.  
when fuel leak is found replace it immediately.

### CHECK BATTERY

Refill the battery with distilled water,  
If the electrolyte fluid is below level line.



# 10. PREPARATIONS FOR STORAGE

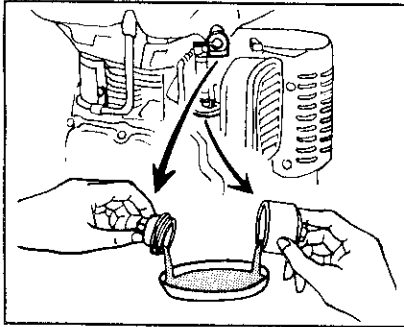

## DISCHARGE FUEL (NO SMOKING !)

- Remove the strainer cup, place the strainer over a container and open the strainer cock to discharge fuel from the fuel tank.
- Remove the carburetor float chamber bolt from the bottom and discharge fuel from the carburetor.

## OIL

- Change the used engine oil with fresh oil.
- Remove the spark plug, pour about 5 cc of engine oil into the cylinder, slowly pull the starter handle of the recoil starter 2 or 3 times, and re-install the spark plug.

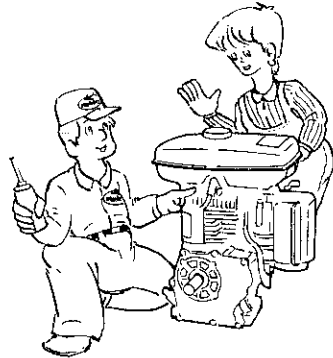

## CLEAN AND STORE

- Slowly pull the recoil starter knob until resistance is felt and leave it in that position.
- Clean the engine thoroughly with an oiled cloth, put the cover on, and store the engine indoors in a well-ventilated, low humidity area.





# 11. SPECIFICATIONS

MODEL	EY15D	EY15B	EY15-2B	EY20D	EY20B	EY28D	EY28B
Type	Air-cooled, 4-cycle single cylinder, side valve, gasoline engine						
Displacement	143 cm <sup>3</sup>			183 cm <sup>3</sup>			273 cm <sup>3</sup>
Continuous Output	1.64KW/3000min <sup>-1</sup> (2.2 HP/3000rpm)	1.64KW/1500min <sup>-1</sup> (2.2 HP/1500rpm)	1.64KW/1500min <sup>-1</sup> (2.2 HP/1500rpm)	2.24KW/3000min <sup>-1</sup> (3 HP/3000rpm)	2.24KW/1500min <sup>-1</sup> (3 HP/1500rpm)	4.10KW/3600min <sup>-1</sup> (5.5 HP/3600rpm)	4.10KW/1800min <sup>-1</sup> (5.5 HP/1800rpm)
	2.01KW/3600min <sup>-1</sup> (2.7 HP/3600rpm)	2.01KW/1800min <sup>-1</sup> (2.7 HP/1800rpm)	2.01KW/1800min <sup>-1</sup> (2.7 HP/1800rpm)	2.61KW/3600min <sup>-1</sup> (3.5 HP/3600rpm)	2.61KW/1800min <sup>-1</sup> (3.5 HP/1800rpm)		
Maximum Output	2.61KW/4000min <sup>-1</sup> (3.5 HP/4000rpm)	2.61KW/2000min <sup>-1</sup> (3.5 HP/2000rpm)	2.61KW/2000min <sup>-1</sup> (3.5 HP/2000rpm)	3.73KW/4000min <sup>-1</sup> (5 HP/4000rpm)	3.73KW/2000rpm (5pk/2000rpm)	5.59KW/4000min <sup>-1</sup> (7.5 HP/4000rpm)	5.59KW/2000min <sup>-1</sup> (7.5 HP/2000rpm)
Direction of Rotation	Counterclockwise, facing P.T.O. Shaft						
Lubricant	Class SC or higher grade, SAE # 20, # 30 # 40						
Fuel	Automobile gasoline (unleaded)						
Fuel Tank Capacity	2.8 liters			3.8 liters			5.5 liters
Spark Plug	NGK B-6HS (CHAMPION L86C)						
Starting System	Recoil starter (Electric starter available as option : except B type)						
Dry Weight	13.2 kg	13.8 kg	14.2kg	15.0 kg	16.0 kg	21.0 kg	21.5 kg
	303mm	306mm	324mm	319mm	324mm	346mm	346mm
Dimensions	300mm	300mm	311mm	317mm	325mm	386mm	386mm
	368mm	368mm	368mm	392mm	392mm	440mm	440mm

The following accessories are available as options :

1. Clighting coil assembly (12V - 15W)
2. Various types of Air cleaners (Cyclone, oil bath)
3. Noiseless spark plug and plug cap
4. Carburetor assembly with drain







# **FUJI HEAVY INDUSTRIES LTD.**

**INDUSTRIAL PRODUCTS DIV.**

Subaru Bldg.

1-7-2, Nishi-Shinjuku, Shinjuku-ku, Tokyo 160, Japan

PHONE ; (Tokyo 03)3347-2420

FACSIMILE ; (Tokyo 03)3347-2418

**PRINTED IN JAPAN**

1997.06<sup>Ⓜ</sup>