

ROSEN®



*a new generation of leadership in mobile video*

# ***ClearVue II Entertainment System***

---

***Owner's Manual***

# NOTICES

## NOTICE OF INTENDED USE

THE CLEARVUE II ENTERTAINMENT SYSTEM IS DESIGNED TO ENABLE VIEWING OF VIDEO RECORDINGS ONLY FOR REAR-SEAT OCCUPANTS.

MOBILE VIDEO PRODUCTS ARE NOT INTENDED FOR VIEWING BY THE DRIVER WHILE THE VEHICLE IS IN MOTION. SUCH USE MAY DISTRACT THE DRIVER OR INTERFERE WITH THE DRIVER'S SAFE OPERATION OF THE VEHICLE, AND THUS RESULT IN SERIOUS INJURY OR DEATH. SUCH USE MAY ALSO VIOLATE STATE LAW.

ROSEN ENTERTAINMENT SYSTEMS DISCLAIMS ANY LIABILITY FOR ANY BODILY INJURY OR PROPERTY DAMAGE THAT MAY RESULT FROM ANY IMPROPER OR UNINTENDED USE.

## About the Registered Marks

*(DVD systems only) This product incorporates copyright protection technology that is protected by method claims of certain U.S. patents and other intellectual property rights owned by Macrovision Corporation and other rights owners. Use of this copyright protection technology must be authorized by Macrovision Corporation, and is intended for home and other limited viewing uses only unless otherwise authorized by Macrovision Corporation. Reverse engineering or disassembly is prohibited.*

*Manufactured under license from Dolby Laboratories. Dolby and the double-D symbol are trademarks of Dolby Laboratories.*

## FCC Approval

*This equipment has been tested and found to comply with the limits for a Class B digital device, pursuant to Part 15 of the FCC Rules. These limits are designed to provide reasonable protection against harmful interference in a residential installation. This equipment generates, uses, and can radiate radio frequency energy and, if not installed and used in accordance with the instructions, may cause harmful interference to radio communications. However, there is no guarantee that interference will not occur in a particular installation. If this equipment does cause harmful interference to radio or television reception, which can be determined by turning the equipment off and on, the user is encouraged to consult the dealer or an experienced radio/TV technician for help.*

---

## Table of Contents

GETTING STARTED .....	6
SWITCHING ON	
LOWERING AND ADJUSTING THE SCREEN	
FINDING THE REMOTE CONTROL BUTTONS YOU NEED	
POWERING ON THE DVD PLAYER OR VCR	
VIEWING	
LISTENING OVER THE VEHICLE SPEAKERS	
INTRODUCTION .....	8
USING THE DISPLAY-MOUNTED CONTROLS .....	9
USING THE REMOTE CONTROL .....	11
BASIC REMOTE CONTROL BUTTONS .....	12
USING MENU AND NAVIGATION BUTTONS .....	14
USING AUDIO BUTTONS .....	15
USING DVD-ONLY BUTTONS .....	16
OPERATING YOUR DVD PLAYER .....	18
OPERATING YOUR VCR .....	19
USING THE HEADPHONES .....	20
LISTENING OVER THE CAR SPEAKERS .....	21
WATCHING BROADCAST TELEVISION (WITH TUNER-EQUIPPED SYSTEMS) .....	21
USING GAMES AND CAMCORDERS .....	22
CHANGING DVD PLAYER OR VCR SETUP .....	22
TROUBLESHOOTING .....	27

---



---

## INTRODUCING THE CLEARVUE II SYSTEM

- 1 RELEASE BUTTON
- 2 LCD DISPLAY
- 3 DOWN BUTTON
- 4 UP BUTTON
- 5 SPEAKER ON/OFF BUTTON
- 6 SOURCE BUTTON
- 7 MUTE BUTTON
- 8 DOME LIGHT ON BUTTON (10.4" DISPLAY ONLY)
- 9 DOME LIGHT DISABLE BUTTON (10.4" DISPLAY ONLY)
- 10 DOME LIGHT
- 11 DOME LIGHT
- 12 ADJUSTER KNOB (6.8" AND 7.0" DISPLAYS)

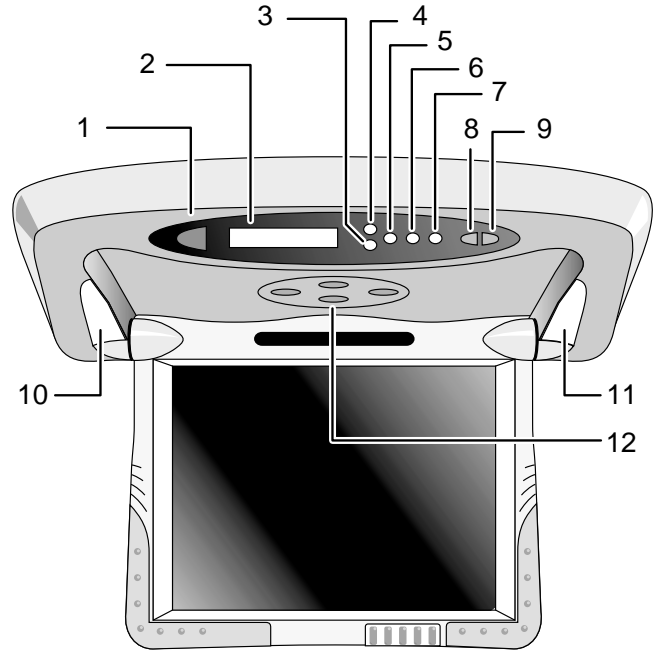

## GETTING STARTED

### Switching On

Use the system when your vehicle is running, or with the ignition switch in the "accessory" position.

### Lowering and Adjusting the Screen

*For 6.8" and 7.0" screens:* Press the release button, as shown. The screen lowers and powers on automatically. To adjust the viewing position, insert two fingers into the adjustment knob and rotate as needed.

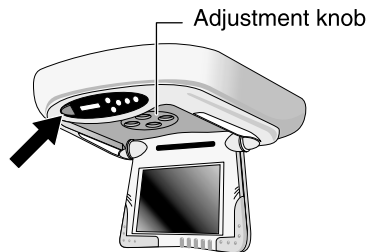

*For 10.4" screens:* Press the release button, as shown. The screen releases slightly and powers on automatically. Manually position it for optimal viewing.

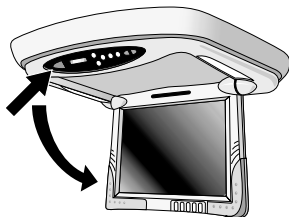

### Finding the Remote Control Buttons You Need



POWER



EJECT



PLAY



SOURCE (on overhead as well)



SPEAKER (on overhead as well)

### Powering On the DVD Player or VCR

Point the remote control at the infrared sensor above the monitor and press **POWER**.

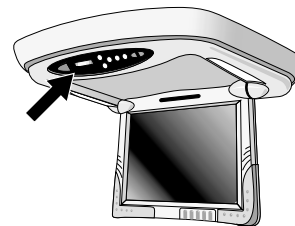

## Viewing

Your ClearVue II system includes *either* a Rosen DVD player or VCR for your video-viewing enjoyment. For more information on operating your DVD player or VCR, see “Operating Your DVD Player” or “Operating Your VCR” in this manual, or see the manual provided with the unit.

### DVD Player Systems

*To Watch a DVD:*

- 1 Press **EJECT** to open the disc loading tray.
- 2 Place a DVD onto the tray label side up, if labelled.
- 3 Press **PLAY** or **EJECT** to retract the disc tray.

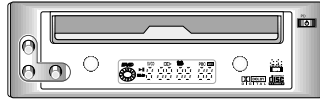

For most DVDs, playback begins automatically. If not, press **PLAY** or **ENTER**.

*To Watch Broadcast Television (on TV Tuner-equipped systems):*

- 1 Press **SOURCE** until TV and a channel number (for example, “2”) appear on the screen.
- 2 Press the **UP CH** and **DOWN CH** arrow buttons on the remote to change channels.

*To Use Another Video Source (optional video game or camcorder):*

- 1 Connect the RCA audio and video outputs of the device to the front of the DVD player.
- 2 Press **SOURCE** until a video image appears on the screen.

### VCR Systems

*To Watch a Video Cassette:*

Insert a VCR into the video tape door. Playback begins automatically.



*To Watch Broadcast Television:*

- 1 Press **SOURCE** until CH\_\_ and the current channel number (for example, “CH 2”) appear on the screen.
- 2 Press the **UP CH** and **DOWN CH** arrow buttons on the remote to change channels.

*To Use Another Video Source (such as an optional video game or camcorder):*

- 1 Connect the RCA audio and video outputs of the device to the front of the VCR.
- 2 Press **SOURCE** until LINE 2 appears on the screen. The video image should now appear on the screen.

### Listening Over the Vehicle Speakers

- 1 Press **SPEAKER** until FM ON appears on the screen.
- 2 Turn on the car radio and tune to FM frequency 88.7. If no ClearVue audio is heard try 89.1.

## INTRODUCTION

Welcome to the *ClearVue II Vehicle Entertainment System Owner's Manual*. The Rosen ClearVue II has been designed to give your vehicle's occupants a more enjoyable journey. Ensure that you and your passengers take time to read these instructions.

Your system includes a combination of the following components:

- An Overhead Monitor—either a 10.4", 7.0" (widescreen), or 6.8" flat panel display
- A Video Cassette Recorder (VCR) with TV Tuner

or

- A DVD/CD/MP3 Player with or without a TV Tuner
- Wireless Infrared (IR) Headphones (2 pair)
- A Remote Control
- A Stereo FM Modulator (enables the video sound to be heard over your vehicle's speakers)
- Other parts and cables which are installed out of sight in your vehicle

## Precautions

- To avoid a dead battery, do not use the system for long periods of time without starting the engine.

- Use this system only after proper installation by a qualified installer.
- If the units show signs of overheating or malfunction, power off the unit and consult your dealer immediately.
- Do not open any of the units; there are no serviceable parts inside.
- Do not press on the monitor unit; this can distort the picture or damage the LCD panel.
- Clean the LCD panel with a slightly damp, soft cloth using household glass cleaner. Do not use solvents such as benzene, thinner, commercially available cleaners or antistatic spray.
- If your car was parked in a very cold or very hot place, the picture may not be clear. The monitor is not damaged. The picture will become clear after the temperature of the ClearVue components returns to normal.
- When using portable radios and telephones near the system, picture or sound interference may occur.

**Note:** *The DVD system voltage range is 11-16VDC operating voltage. The system operating temperature is 0° to 50° Celsius. Use of the DVD Player beyond the safe operating ranges listed can cause temporary or permanent damage to the unit, and such damage may not be covered by the manufacturer's warranty.*



## USING THE DISPLAY-MOUNTED CONTROLS

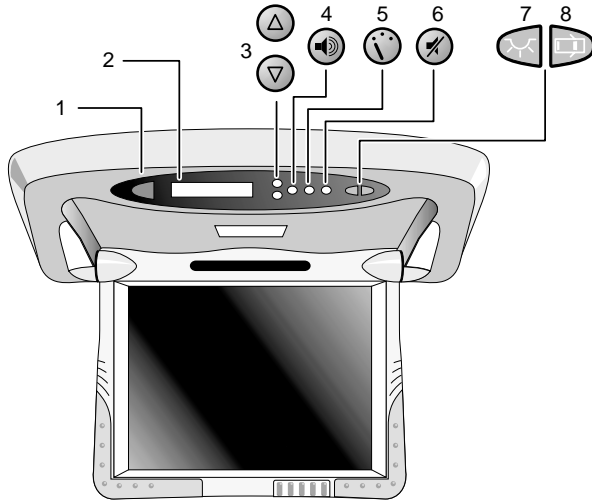

- 1 **Release**—Press to lower the screen.
- 2 **LCD Display**—Displays information about your system's status.
- 3 **Up/Down**—Press both buttons at the same time to access the FPD Menu and change the color, contrast, brightness, and tint of your flat panel display monitor. See "Changing Monitor Settings".

- 4 **Source**—Press to select a viewing source.

**DVD:** Press to select DVD mode, TV mode, or auxiliary mode.

**VCR:** Press to select VCR mode, TV mode, Line 1, or Line 2.

- 5 **Speaker On/Off**—Press to turn on/off the FM Modulator.

When the FM Modulator is on, you can hear ClearVue audio over the vehicle's speakers. When the FM Modulator is off, you can hear ClearVue audio by using the supplied wireless headphones. To listen to the vehicle sound system normally, turn off the FM Modulator.

- 6 **Mute**—Mutes ClearVue audio to FM Modulator and headphones.

- 7 **Dome Light On**—10.4" displays only. Press to turn on the dome light when the doors are closed. Press again to turn the dome light off. When backlit *red*, dome light stays on whether the door is open or closed.

- 8 **Dome Light Disable**—10.4" displays only. Press to prevent illumination when a door is open. When backlit *red*, dome light remains off, even when doors are open.

*Note: When dome light buttons are backlit green, dome lights operate normally, illuminating when a door opens and turning off when doors close. See "Using the Dome Lights".*

## Changing Monitor Settings

The ClearVue II monitor has adjustable settings for color, contrast, brightness, and tint. To change these settings, press the **UP CH** and **DOWN CH** arrow buttons *on the overhead console* at the same time, and hold for two seconds. A menu with the following options appears:

COLOR	(32)
CONTRAST	(32)
BRIGHT	(32)
TINT	(32)

*To select a setting to be changed:* Press **SOURCE** to move the cursor up and down the menu list.

*To change the value of a setting:* Use the **UP CH** and **DOWN CH** arrow buttons to decrease and increase the setting. The range of values is from zero to 63, with 32 as the default.

*To exit the menu:* Press the **UP CH** and **DOWN CH** arrow buttons at the same time, and hold for two seconds.

*Note: While it is not technically a “monitor” setting, the DVD player can be configured for a widescreen output compatible with the ClearVue7” screen. This will eliminate or greatly reduce the “black bars” on the top and bottom of the 7” screen when viewing a “widescreen” DVD when the DVD Player is in “Normal” screen mode. Please see “Changing the Aspect Ratio Mode” on page 24 for more information.*

## Using the Dome Lights

The ClearVue II overhead consoles have built-in dome lights. This is due to installation requirements in many vehicles, where the factory dome light is removed during installation of the overhead console.

*For 6.8” and 7.0” displays:* The dome light operates just as the original factory dome light did—illuminated when the door is open and off when the doors are closed.

*For 10.4” displays:* There are two dome light control buttons on the overhead console. Press to turn on/off the following features.



Dome Light On



Dome Light Disable

When backlit *green*: The dome lights operate normally, illuminating when a door opens and turning off when the doors close.

When backlit *red*:

Dome Light On—Dome light stays on whether the door is open or closed.

Dome Light Disable—Dome light is off while door is open. Use this button when the door is open for long periods of time to prevent draining the battery.

*Note: Some vehicles have a dome light dimming feature that causes the dome light to fade out gradually. The 10.4” system dome light may not fade in the exact manner as the factory dome light, but will still turn on and off normally in conjunction with the use of the vehicle’s doors. This is proper operation for the system. If you have any questions, contact your Rosen authorized dealer.*

## USING THE REMOTE CONTROL

Use the ClearVue II remote control to operate both your monitor and DVD player or VCR. Always aim the ClearVue II remote control at the infrared sensor on the monitor, not at the DVD player or VCR.

*Note: You may receive a dedicated remote control for your DVD player or VCR. We recommend that you store this additional remote in a safe place for later use, if needed.*

Adjust volume using the volume control on the headphones or the vehicle radio. There is no volume control on the ClearVue II remote or overhead console.

1	Pause/Frame Step	15	No Function
2	Power	16	Play
3	Previous Track	17	Next Track
4	Rewind/Reverse	18	Forward/Search
5	Speaker	19	Mute
6	Equalizer (DVD Only)	20	No Function
7	Source	21	Eject
8	Up	22	Stop
9	Left	23	Status
10	Enter	24	Right
11	Setup Menu	25	Zoom
12	Subtitle	26	Format
13	Down	27	No Function
14	Angle	28	Audio

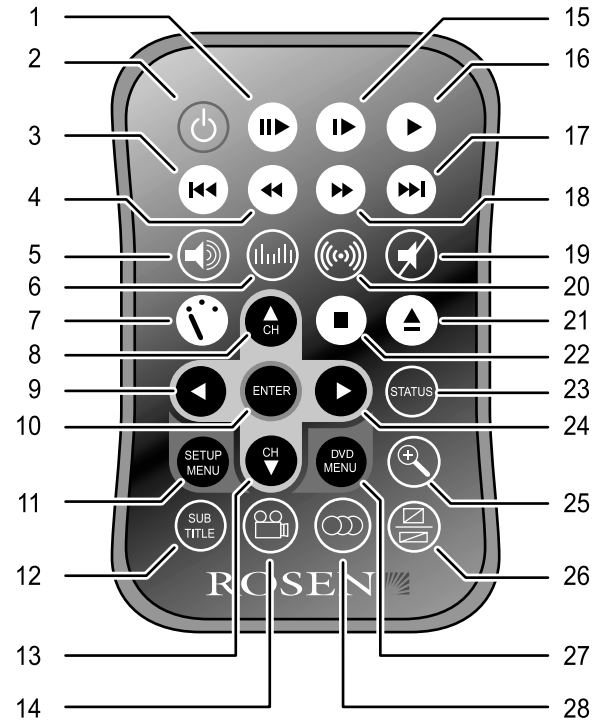

ON ON

When the Rosen ClearVue II monitor is open in the viewing position, press the **POWER** button.

ROSEN

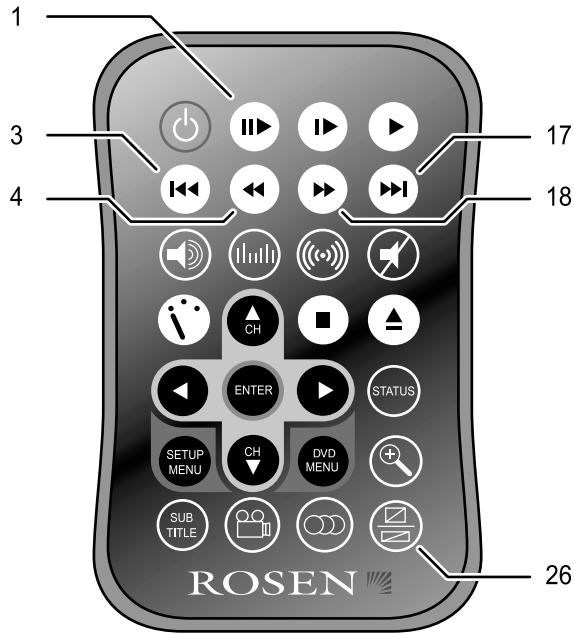

## BASIC BUTTONS, CONTINUED

### 1 Pause/Frame Step

Press once to pause playback or press repeatedly to advance video frame by frame. To resume normal playback, press **PLAY**.

### 3 Previous Track (DVD only)

Press to jump to the previous title or chapter, if available on a DVD, or to the previous track on an audio CD.

### 4 Rewind/Reverse (VCR only)

Press to rewind. To resume normal playback, press **PLAY**.

### 17 Next Track (DVD only)

Press to jump to the next title or chapter, if available on a DVD, or to the next track on an audio CD.

### 18 Forward/Search

**DVD:** Press during playback to fast forward. Press the **RIGHT** and **LEFT** arrow buttons to adjust search direction and speed. Options include 2x, 4x, 6x, 8x, 12x, 16x, 32x, and 64x. Press **PLAY** to resume regular play.

**VCR:** Press to fast forward. To resume normal playback, press **PLAY**.

### 26 Reserved

This button is reserved for future feature additions to the system.

ReRulIC MumuSeuilyCeaCEoaaluCiiCCWtuMCaMCwD OSMYCaün

6sMulIC MumuSeuilyCeaCEoaaluCvCCWtuMCDtuC CaMC DtU C

Swiwo OSMYCOtmwcl CaiIn

IRi5 O

SSiy

sMulICeaCauCwmCaMCaRtCotCSCutwCaMceaCeOStuCEoSttu CRout  
RSEEOUCh

L ams  
sMulICeaCSwleCeMSEOtCatCeouCvCRoutCOuROtCSCOUaeSmunil

sMulICeaCSüCSCütWClu uEeOatn

inil

IuCeacnuMlatS OüCamuMSeOatCaCyawMCiiCm SyuMCaMcvnCäMcaMu  
OtaMSeOatCluuCvOStOtCiiCs SyuMCaMcvCuewmin

niy

ReRulIC MumuSeuilyCeaCDuRCeouCieSewICEwMMuteCeOe uCtwüMCeMSE  
twüMCSStCeouCeaes Cm SyOtCeOuCaCeouCDIECatCeouCatOeaMn

eMlilCeaCDuRCOtäMSeOatCSaweCeouCEwMMuteClawMEuCSStCÜia

ESllueeuCOtE wDtCMuEaMOtCImuuCStCu SmluCeOün



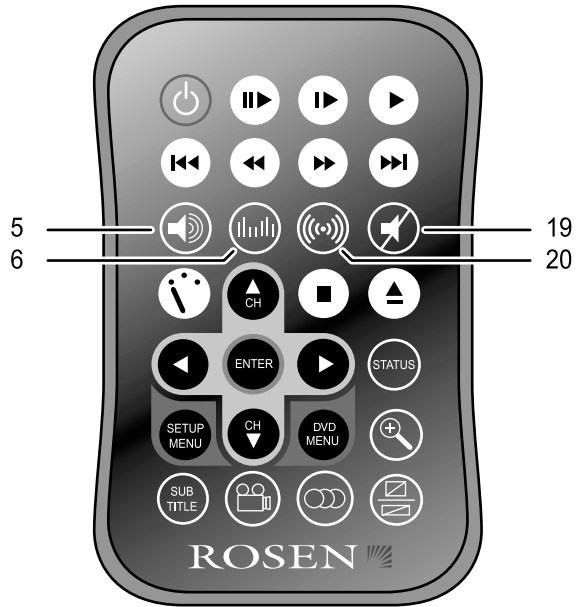

## USING AUDIO BUTTONS

### 5 Speaker

While your car radio is on, press once to hear ClearVue audio through the car speakers; FM ON appears on the screen. Headphone audio is not affected.

Press again to hear ClearVue audio only through the headphones; FM OFF appears on the screen.

*Note: The Speaker button on the overhead console performs the same function.*

Refer to “Using the Headphones” and “Listening Over the Car Speakers” for additional details.

### 6 Equalizer

This button accesses the internal graphic equalizer.

### 19 Mute

Press once to mute the audio. Press again to return to normal audio.

*Note: The Mute button on the overhead console performs the same function.*

### 20 Reserved

This button is reserved for future feature additions to the system.

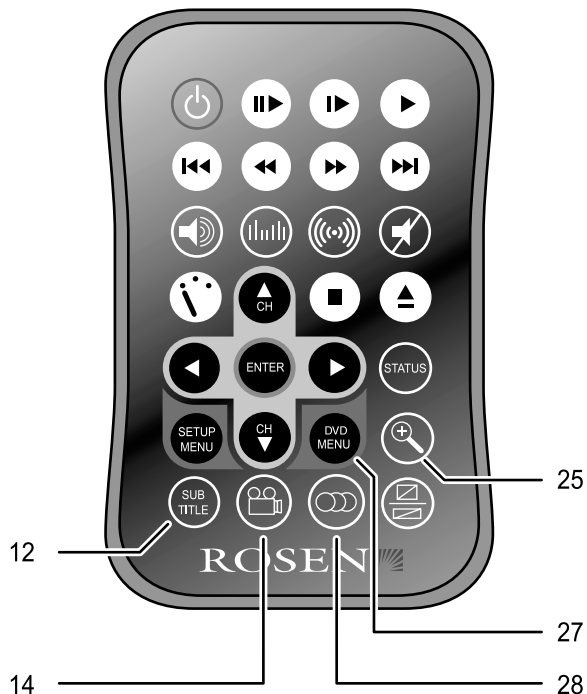

## USING DVD-ONLY BUTTONS

Some DVDs include menu and viewing options. Use the following buttons to access DVD-only menus and features. For more information, see your owner's manual for your DVD player.

### 12 **Subtitle**

Press repeatedly to cycle through the language options, if available.

### 14 **Angle**

Press to view the same scene at different angles, if available.

### 25 **Zoom**

View the same scene at different magnifications.

- 1 Press the **ZOOM** button during playback to toggle between the following options: x1.5, x2, and x4.
- 2 Press the arrow buttons to shift the magnified section of the screen.
- 3 Press **ZOOM** until Zoom off appears to resume normal playback.

### 27 **DVD Menu**

Press to see the main menu for the DVD you are playing. To resume normal playback, press **PLAY**.

### 28 **Audio**

Press to use DVDs or VCDs with different audio tracks, if available.



## Replacing the Remote Battery

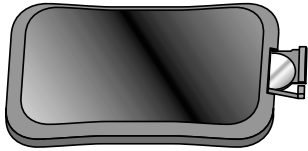

Use one CR2025 3V battery. Battery life is approximately six months depending on how often the remote is used.



...es playback.  
... loading and removal.  
... Left and Yellow Video inputs  
*...ue II remote control must be aimed at the  
the overhead console, not the DVD player.*



## OPERATING YOUR VCR

This manual describes most of the VCR's functions. For more detail, please refer to the manual provided with your VCR.

*Note: The system is sensitive to extreme temperatures and excess moisture. If the HEAT/DEW indicator on the face of the VCR illuminates, the VCR is unable to load a video tape, and the TV tuner is inoperable. If this occurs, wait until the temperature returns to a normal range and any moisture condensation has had time to evaporate before using the system.*

### Front Panel Controls

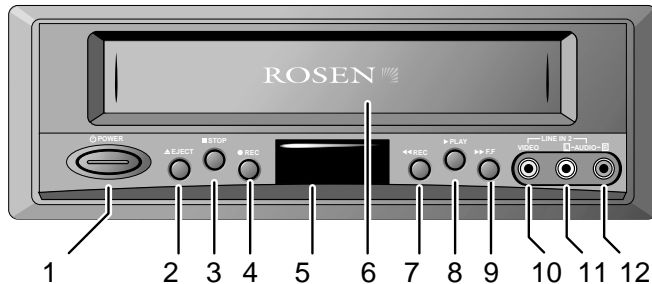

- 1 Power—Powers the system on and off.
- 2 Eject—Ejects the video cassette.
- 3 Stop—Stops playback.
- 4 Record—Records video.
- 5 Indicator lights—For power, recording, SLP, and Heat/Dew modes.
- 6 Video cassette tape door—Insert video cassettes here.
- 7 Rewind—Rewinds video cassette.
- 8 Play—Begins or resumes playback.
- 9 Fast forward—Fast forwards video cassette.
- 10 Aux input—Right channel audio input, red.
- 11 Aux input—Left channel audio input, white.
- 12 Aux input—Video input, yellow.

## USING THE HEADPHONES

Using the headphones with your system allows rear-seat passengers to listen to their DVD, CD, video cassette, or video game without disturbing front-seat passengers. When headphones are in use with the system, front-seat passengers can use the vehicle's audio system as usual through the car speakers.

The system comes with wireless IR headphones that receive a signal from the IR transmitter on the overhead display.

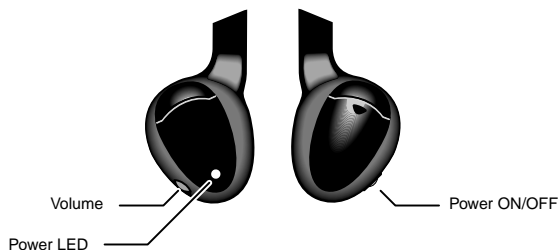

To turn the headphones on and off, push the Power ON/OFF button on the right ear piece. The Power LED on the left ear piece indicates when headphone power is on. Power turns off automatically after three minutes of no audio to preserve battery life.

To adjust the headphone volume, rotate the thumb wheel switch on the headphones.

The wireless IR headphones require two AAA batteries. To replace the batteries, remove the battery compartment cap on the right earpiece and insert batteries, as shown.

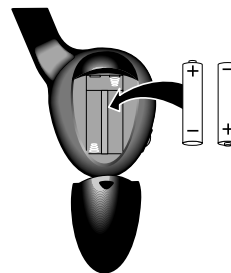

## LISTENING OVER THE CAR SPEAKERS

Each time the vehicle is started, the ClearVue II FM Modulator remains off until turned on by the user. This allows normal use of the vehicle's audio system.

To listen to ClearVue II system audio through your car speakers:

- 1 Press **SPEAKER** until FM ON appears on the screen.
- 2 Turn on the car radio.
- 3 Tune the car radio to the FM frequency 88.7; this is the default system frequency.

If audio from the DVD player or VCR does not play over the car speakers, tune the radio to 89.1 FM. This is an alternate system frequency.

To turn off ClearVue II system audio over the car speakers, press **SPEAKER**. FM OFF appears on the screen. Audio from the ClearVue II system is then available over the headphones only.

## WATCHING BROADCAST TELEVISION (ON TV TUNER-EQUIPPED SYSTEMS)

You can watch television on ClearVue II systems equipped with source units with internal TV Tuners.

*Note: Broadcast television reception varies with location, terrain, distance from the broadcast tower, and other factors. Signal quality is likely to vary in a moving vehicle.*

### DVD Player Systems

- 1 Press **SOURCE** until TV and a channel number (for example, "2") appear on the screen.
- 2 Press the **UP CH** and **DOWN CH** arrow buttons on the remote to change channels.

### VCR Systems

- 1 Press **SOURCE** until CH\_\_ (for example, "CH 2") appears on the screen.
- 2 Press the **UP CH** and **DOWN CH** arrow buttons on the remote to change channels.

## USING GAMES AND CAMCORDERS

You may use video games, camcorders, and other portable video units by connecting the unit to the color-coded auxiliary inputs located on the front of your DVD player or VCR.

Red—Right channel audio input

White—Left channel audio input

Yellow—Video input

Press **SOURCE** to select among DVD/VCR, TV Tuner, and other video sources.

To use a game system, a “power inverter,” available at most electronic retail stores, is required.

## CHANGING DVD PLAYER OR VCR SETUP

You can personalize operation of your DVD player or VCR by changing settings in the Setup menu.

- 1 Press **SETUP MENU** on the remote control to access the menu.
- 2 Press the right arrow to move the cursor and highlight your desired selection.
- 3 Press **ENTER** to scroll among the options for your selection.
- 4 Press **SETUP MENU** again to resume playback.

**DVD:** Includes options for various language, display, audio, and parental control features. For more information about these options see your DVD player owner's manual.

- Language Setup—Change OSD, audio, subtitle, and disc menu languages. Audio, subtitle, and disc menus can only be adjusted when playback is stopped.
- Display Setup—Set TV display, TV type, picture mode, and viewing angle. Turn on/off subtitles and the screen saver.
- Audio Setup—Adjust digital audio output, dynamic range, stereo and two-channel audio.
- Parental Control—Set parental control level and password.

**VCR:** Includes options for general VCR-operating features.

- Record Speed—SP and SLP modes. For details on recording, please see the VCR manual.
- Auto Repeat—Turn off/on automatic video cassette repeat.
- Audio Output—Choose from Hi-Fi, left, right, and mono.
- VCR Output CH—Select channel 3 or 4.

## DVD Parental Control

Parental Control allows authorized users to select an upper limit to film ratings that can be played. If a DVD is inserted that exceeds that rating, one of the following screens appears:

*Screen Type 1:* In order for the film to play, the viewer must select “Yes,” and then the four-digit numeric “password” must be entered.

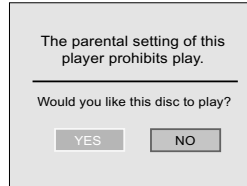

*Screen Type 2:* In order for the film to play, the viewer must press “Setup”, and change the parental control level for the DVD player using the password. For more information, see the Setup section of this manual.



The factory default password is 3308. The password can be changed—see section “*Setup*.” The film ratings allowed are also selected in the “*Setup*” section.

### Notes:

- To change the film rating setting, the password must be used.
- The DVD Player determines the correct film ratings to use based on the country selected in the “*Locale*” setting.
- Not all DVD titles support this feature.

## DVD TYPICAL SETUP AND CONFIGURATION

The following sections explain how to customize various features of the DVD Player.

To change settings for your DVD Player:

- 1 Press SETUP.
- 2 Use the up and down buttons to highlight a selection.
- 3 Press the ENTER button to confirm your selection.

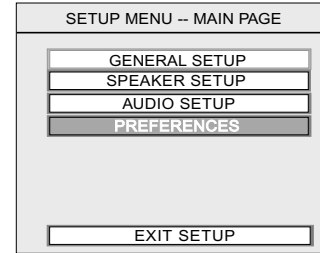

If you try to perform an action that is not permitted (such as accessing the Preferences menu while a disc is playing), the on-screen display will use the following symbol:



## Changing the Aspect Ratio Mode

To change the aspect ratio mode, select GENERAL, and then select TV DISPLAY. For the 7" widescreen monitor, select WIDE. For 6.8" and 10.4" monitors and letterbox viewing (black bars on the top and bottom of the screen, but the entire image preserved), select NORMAL/LB. For 6.8" and 10.4" monitors and a full-screen image, but with the edges variably cropped to fit ("pan-and-scan" mode), select NORMAL/PS.

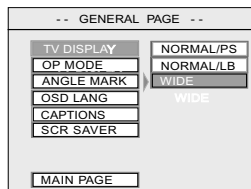

## Changing the Video Output Mode

To change the video output mode, select PREFERENCES, and then select TV TYPE. The default is MULTI. If you experience problems playing a PAL disc on your NTSC monitors, select NTSC.

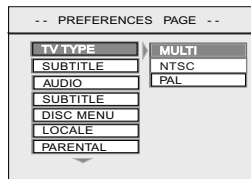

*Note:*

The default "MULTI" will automatically output NTSC video from NTSC discs, and PAL video from PAL discs. NTSC is the North American standard used in the ClearVue systems, and the only type of disc many North American users will encounter.

## Concealing the "Angle Mark"

To display or conceal the "angle mark," which appears during scenes that support the multiple-viewing-angle feature, select GENERAL and ANGLE MARK.

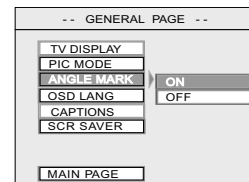

## Activating Captions and Subtitles

To enable or disable captions or subtitles, select GENERAL and CAPTIONS.

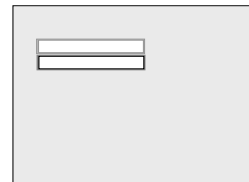

*Note:*

If CAPTIONS is set to OFF, the [SUBTITLE] button will be defeated from working. If SUBTITLE OFF is selected under Preferences – Audio, then the [SUBTITLE] button can still enable subtitles during playback, as long as CAPTIONS is set to ON.



## Activating the Digital Output

To turn on the digital output, select AUDIO and AUDIO OUT.

*Note:*

*Only enable the digital output when an optional digital audio processor is in use, since enabling it disables the analog audio output used by the FM Modulator and the IR headphones. Note that some digital audio processors will require you to select an LPCM output frequency.*

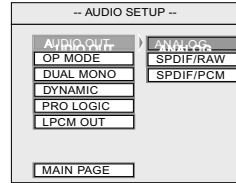

## Deactivating the “Smart Nav” On-Screen Menu Display

To play MP3 discs without the “Smart Nav” on-screen menu display, select PREFERENCES, then SMART NAV.

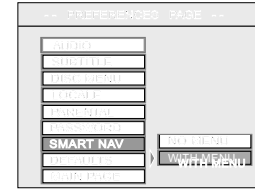

## Changing Language Settings

Several language settings can be customized on the DVD Player.

*Notes:*

- *Not all language settings are supported by all discs.*
- *The languages supported by the R5505 vary by individual option setting.*

## Selecting an LPCM Output Frequency

To select an LPCM output frequency (when a digital audio processor is in use), select AUDIO and LPCM OUTPUT.

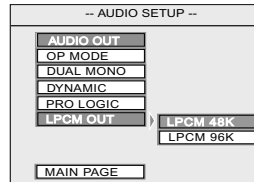

To change the on-screen display language, select GENERAL and OSD LANG.

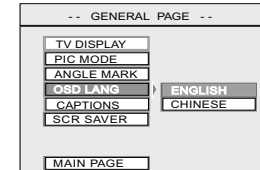

*(Changing Language Settings continued)*

**To change the soundtrack language,** select PREFERENCES and AUDIO.

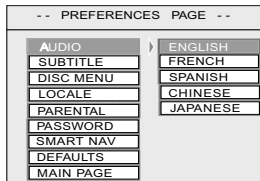

**To change the subtitle or caption language,** select PREFERENCES and SUBTITLE.

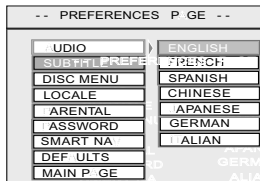

**To change the disc menu language,** select PREFERENCES and DISC MENU.

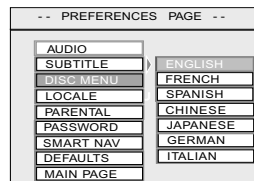

## DVD Setup Options List

The factory default options are given in bold type.

### GENERAL PAGE

TV DISPLAY: **NORMAL/PS**, NORMAL/LB, WIDE.  
 PICMODE: **AUTO**, HI-RES, N-FLICKER  
 ANGLE MARK: **ON**, OFF  
 OSD LANG: **ENGLISH**, CHINESE  
 CAPTIONS: **ON**, OFF  
 SCRN SAVER: **OFF**, ON

### SPEAKER SETUP

DOWNMIX: LT/RT, **STEREO**

### AUDIO SETUP

AUDIO OUTPUT: **ANALOG**, SPDIF/RAW, SPDIF/PCM  
 OP MODE: **LINE OUT**, RF REMOD  
 DUAL MONO: **STEREO**, L-MONO, R-MONO, MIX-MONO  
 DYNAMIC: OFF to **FULL** (eight steps)  
 PRO LOGIC: **OFF**, ON, AUTO  
 LPCM OUTPUT: **LPCM 48K**, LPCM 96K

### PREFERENCES PAGE

TV TYPE: **MULTI**, NTSC, PAL  
 AUDIO: **ENGLISH**, FRENCH, SPANISH, CHINESE, JAPANESE  
 SUBTITLE: **ENGLISH**, FRENCH, SPANISH, CHINESE, JAPANESE, OFF  
 DISC MENU: **ENGLISH**, FRENCH, SPANISH, CHINESE, JAPANESE  
 LOCALE: CHINA, FRANCE, HONG KONG, JAPAN, TAIWAN, GBR, **USA**  
 PARENTAL: **OFF**  
 PASSWORD: **3308**  
 SMART NAV: **ON**, OFF

## TROUBLESHOOTING

### NO PICTURE, NO SOUND

**Voltage.** The ClearVue II system has low- and high-voltage protection circuits. If the voltage goes beyond the limits, the system shuts off.

**Temperature.** The vehicle interior is too hot or too cold. Let the vehicle cool down or warm up before using the system.

**Power.** The power wire or power harness has been disconnected, or the fuse has failed. Contact your Rosen authorized dealer.

### GOOD PICTURE, BUT NO SOUND OR DISTORTED, “TINNY” SOUND

**Volume.** Check volume on radio.

**HEADPHONES.** Check headphones; ensure the headphones have a direct “line of sight” to the infrared sensor above the monitor.

**Headphone battery.** Replace headphone batteries, if needed.

**DVD Setup.** Check the “Downmix” setting in the SETUP menus and ensure that it is set to “Stereo,” not “LT/RT.” Also check the Audio Output setting and make sure it is set to “Analog”

### GOOD SOUND, BUT BLURRY PICTURE

The system components are too cold. Allow the interior of the vehicle to warm up before using the ClearVue II system.

### PICTURE DISTORTS, “ROLLS”, APPEARS BLACK AND WHITE.

Check that the DVD Player’s TV Type setting is correct. PAL video often “rolls” on NTSC monitors.

### NO RESPONSE WHEN PRESSING REMOTE BUTTONS

Check the batteries in the remote control. Ensure that the infrared sensor on the overhead display is not obstructed.

### RADIO PLAYS STATIC OR HAS NO RECEPTION

Press **SPEAKER** to switch the car speakers from the ClearVue II system to radio.

### THE DOME LIGHT ON THE CONSOLE DOES NOT WORK

If you have a 10.4” display, check that the Dome Light Disable button on the monitor is backlit green; if red, press to change to green.

Replace the dome light with a 5-watt or less bulb.

### OVERHEAD DISPLAY BUTTONS BLINK

When the overhead display buttons are blinking, the vehicle interior is too hot or too cold. Allow the interior of the vehicle to cool down or warm up before using the ClearVue II system.

### WITH A 7” WIDESCREEN MONITOR, I HAVE BLACK BARS ON THE TOP AND BOTTOM OF MY SCREEN.

Change the DVD Player’s TV Display mode to “Wide.”

“Widescreen” movies are made in various aspect ratios. 1.85:1 images almost perfectly fill a 16:9 screen (such as the 7” ClearVue). 2.35:1 images will still have black bars, but they will be much smaller than when viewing 2.35:1 images on a 4:3, non-widescreen monitor.

**Note: The system voltage range is 11-16VDC operating voltage. The system operating temperature is 0° to 50° Celsius. Use of the DVD Player beyond the safe operating ranges listed can cause temporary or permanent damage to the unit, and such damage may not be covered by the manufacturer’s warranty.**

PN 9100159 Rev B

© 2003 Rosen Entertainment Systems LLC

*[www.rosenenertainment.com](http://www.rosenenertainment.com)*

**888-GO-ROSEN**

All rights reserved.

No part of this publication may be reproduced, stored in a retrieval system or transmitted in any form, electronic, mechanical, recording or other means without prior written permission from Rosen.