

Trinitron[®] Color Computer Display

Operating Instructions _____

EN

C

*CPD-100GS
CPD-200GS*

Owner's Record

The model and serial numbers are located at the rear of the unit. Record the serial number in the space provided below. Refer to these numbers whenever you call upon your dealer regarding this product.

Model No. _____ Serial No. _____

WARNING

To prevent fire or shock hazard, do not expose the unit to rain or moisture. Dangerously high voltages are present inside the unit. Do not open the cabinet. Refer servicing to qualified personnel only.

FCC Notice

This equipment has been tested and found to comply with the limits for a Class B digital device, pursuant to Part 15 of the FCC Rules. These limits are designed to provide reasonable protection against harmful interference in a residential installation. This equipment generates, uses, and can radiate radio frequency energy and, if not installed and used in accordance with the instructions, may cause harmful interference to radio communications.

However, there is no guarantee that interference will not occur in a particular installation. If this equipment does cause harmful interference to radio or television reception, which can be determined by turning the equipment off and on, the user is encouraged to try to correct the interference by one or more of the following measures:

- Reorient or relocate the receiving antenna.
 - Increase the separation between the equipment and receiver.
 - Connect the equipment into an outlet on a circuit different from that to which the receiver is connected.
 - Consult the dealer or an experienced radio/TV technician for help.
- You are cautioned that any changes or modifications not expressly approved in this manual could void your authority to operate this equipment.

Declaration of Conformity

According to 47CFR Parts 2 and 15 for
Class B Personal Computers and Peripherals

Trade Name: Sony
Model No.: CPD-100GS and CPD-200GS
Responsible Party: Sony Electronics Inc.
Address: 1 Sony Drive, Park Ridge,
NJ, 07656
Telephone No.: 201-930-6970

This device complies with Part 15 of the FCC Rules. Each product marketed, is identical to the representative unit tested and found to be compliant with the standards. Records maintained continue to reflect the equipment being produced can be expected to be within the variation accepted, due to quantity production and testing on a statistical basis. Operation is subject to the following two conditions: (1) This device may not cause harmful interference, and (2) this device must accept any interference received, including interference that cause undesired operation.

Hinweise

- Aus ergonomischen Gründen wird empfohlen, die Grundfarbe Blau nicht auf dunklem Untergrund zu verwenden (schlechte Erkennbarkeit, Augenbelastung bei zu geringem Zeichenkontrast).
- Aus ergonomischen Gründen (flimmern) sollten nur Darstellungen bei Vertikalfrequenzen ab 70 Hz (ohne Zeilensprung) verwendet werden.
- Die Konvergenz des Bildes kann sich auf Grund des Magnetfeldes am Ort der Aufstellung aus der korrekten Grundeinstellung verändern. Zur Korrektur empfiehlt es sich deshalb, die Regler an der Frontseite für Konvergenz so einzustellen, daß die getrennt sichtbaren Farblinien für Rot, Grün und Blau bei z.B. der Darstellung eines Buchstabens zur Deckung (Konvergenz) gelangen. Siehe hierzu auch die Erklärungen zu Konvergenz.

NOTICE

This notice is applicable for USA/Canada only. If shipped to USA/Canada, install only a UL LISTED/CSA LABELLED power supply cord meeting the following specifications:

SPECIFICATIONS

Plug Type	Nema-Plug 5-15p
Cord	Type SVT or SJT, minimum 3 × 18 AWG
Length	Maximum 15 feet
Rating	Minimum 7 A, 125 V

NOTICE

Cette notice s'applique aux Etats-Unis et au Canada uniquement.

Si cet appareil est exporté aux Etats-Unis ou au Canada, utiliser le cordon d'alimentation portant la mention UL LISTED/CSA LABELLED et remplissant les conditions suivantes:

SPECIFICATIONS

Type de fiche	Fiche Nema 5-15 broches
Cordon	Type SVT ou SJT, minimum 3 × 18 AWG
Longueur	Maximum 15 pieds
Tension	Minimum 7 A, 125 V



As an ENERGY STAR Partner, Sony Corporation has determined that this product meets the ENERGY STAR guidelines for energy efficiency.

TABLE OF CONTENTS

Getting started

Precautions	4
Identifying Parts and Controls	5
Setup	6
Selecting the On-screen Display Language	6
Connecting Your Monitor's Speaker	7

Customizing Your Monitor

Adjusting the Picture Brightness and Contrast	8
Introducing the On-screen Display System	8
Using the CENTER On-screen Display	9
Using the SIZE On-screen Display	9
Using the GEOM (Geometry) On-screen Display	10
Using the ZOOM On-screen Display	11
Using the COLOR On-screen Display	11
Using the SCREEN On-screen Display	12
Using the OPTION On-screen Display	13
Resetting the Adjustments	15
Selecting the Graphic Picture Enhancement (GPE) Mode	16

EN

Technical Features

Preset and User Modes	16
Displaying the monitor's information	17
Power Saving Function	17
Damper Wires	17
Plug & Play	17

Additional Information

Warning Messages	18
Troubleshooting	18
Self-diagnosis Function	20
Specifications	20

- Macintosh is a trademark licensed to Apple Computer, Inc., registered in the U.S.A. and other countries.
- Windows® is a registered trademark of Microsoft Corporation in the United States and other countries.
- IBM PC/AT and VGA are registered trademarks of International Business Machines Corporation of the U.S.A.
- VESA is a trademark of Video Electronics Standard Association.
- All other product names mentioned herein may be the trademarks or registered trademarks of their respective companies.
- Furthermore, "™" and "®" are not mentioned in each case in this manual.

Precautions

Installation

- Prevent internal heat build-up by allowing adequate air circulation. Do not place the monitor on surfaces (rugs, blankets, etc.) or near materials (curtains, draperies) that may block the ventilation holes.
- Do not install the monitor near heat sources such as radiators or air ducts, or in a place subject to direct sunlight, excessive dust, mechanical vibration or shock.
- Do not place the monitor near equipment which generates magnetism, such as a transformer or high voltage power lines.

Maintenance

- Clean the cabinet, panel and controls with a soft cloth lightly moistened with a mild detergent solution. Do not use any type of abrasive pad, scouring powder or solvent, such as alcohol or benzine.
- Do not rub, touch, or tap the surface of the screen with sharp or abrasive items such as a ballpoint pen or screwdriver. This type of contact may result in a scratched picture tube.
- Clean the screen with a soft cloth. If you use a glass cleaning liquid, do not use any type of cleaner containing an anti-static solution or similar additive as this may scratch the screen's coating.

Transportation

When you transport this monitor for repair or shipment, use the original carton and packing materials.

Use of the Tilt-Swivel

With the tilt-swivel, this monitor can be adjusted to the desired angle within 180° horizontally and 20° vertically. To turn the monitor vertically and horizontally, hold it at the bottom with both hands as illustrated below.

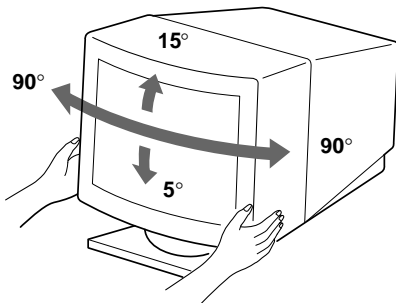

Warning on power connection

- Use an appropriate power cord for your local power supply.
- Before disconnecting the power cord, wait at least 30 seconds after turning off the power to allow the static electricity on the CRT display surface to discharge.
- After the power has been turned on, the CRT is demagnetized (degaussed) for about 5 seconds. This generates a strong magnetic field around the metal frame, which may affect the data stored on magnetic tapes and disks near the bezel. Place magnetic recording equipment, tapes and disks away from this monitor.

The outlet should be installed near the equipment and be easily accessible.

Identifying Parts and Controls

See the pages in parentheses for further details.

Front

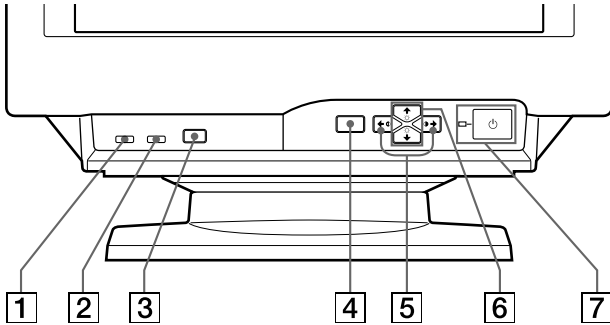

- 1 MUTING button (page 7)**
Mutes the sound.
- 2 RESET button (page 15)**
Resets the adjustments to the factory settings.
- 3 GPE button (page 16)**
Selects the Graphic Picture Enhancement (GPE) mode.
- 4 MENU button (pages 7 -15, 17)**
Displays the MENU OSD.
- 5 ◂ (contrast) (◄/►) buttons (pages 7 - 15, 20)**
Adjust the contrast.

Function as the (◄/►) buttons when adjusting other items.
- 6 ☀ (brightness) (↓/↑) buttons (pages 7 - 15)**
Adjust the picture brightness.

Function as the (↓/↑) buttons when adjusting other items.
- 7 ⏻ (power) switch and indicator (pages 17, 20)**
Turns the monitor on or off.
The indicator lights up in green when the monitor is turned on, and either flashes in green and orange or lights up in orange when the monitor is in power saving mode.

Rear

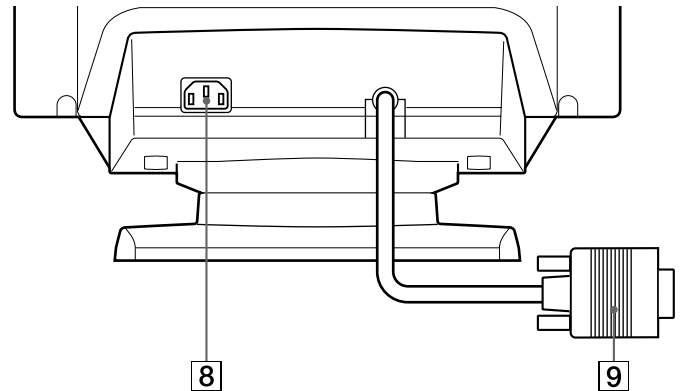

- 8 AC IN connector**
Provides AC power to the monitor.
- 9 Video input connector (HD15)**
Inputs RGB video signals and SYNC signals.

EN

Side

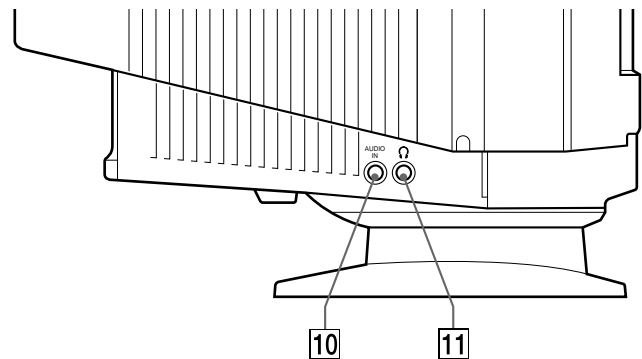

- 10 AUDIO IN jack**
Inputs audio signals when connected to the computer's audio out jack.
- 11 🎧 Headphones jack**
Outputs audio signals to headphones (not supplied).

Setup

Before using this monitor, check that the following items are included in your carton:

- Monitor (1)
- Power cord (1)
- Macintosh adapter (1)
- Windows® 95 Monitor Information Disk and its manual (1)
- Warranty card (1)
- These operating instructions (1)
- Audio miniplug cord (1)

This monitor works with any IBM or compatible system equipped with VGA or greater graphics capability. Although this monitor works with other platforms running at horizontal frequencies between 30 and 70 kHz (CPD-100GS), 30 and 85 kHz (CPD-200GS), including Macintosh and Power Macintosh systems, a cable adapter is required. Please consult your dealer for advice on which adapter is suitable for your needs.

Step 1: Connect the monitor to the computer

Connecting to an IBM PC/AT, Macintosh or compatible computer

With the computer switched off, connect the video signal cable to the computer's video output.

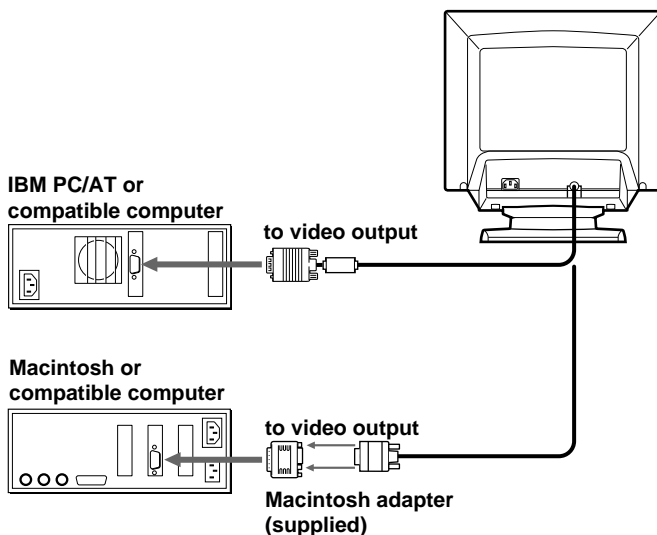

About the supplied Macintosh adapter

The supplied Macintosh adapter is compatible with Macintosh LC, Performa, Quadra and Power Macintosh series computers. Macintosh II series and some older versions of Power Book models may need an adapter with micro switches (not supplied).

Note

Do not short the pins of the video signal cable.

Step 2: Connect the power cord

With the monitor switched off, connect one end of the power cord to the monitor and the other end to a power outlet.

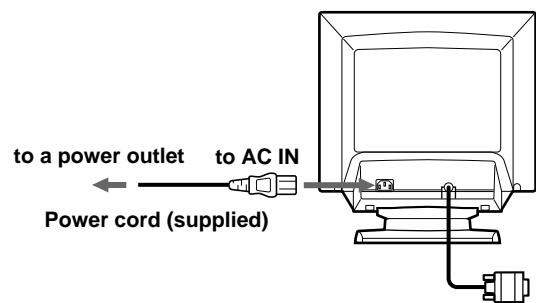

Step 3: Turn on the monitor and computer

The installation of your monitor is complete.

Note

If "OUT OF SCAN RANGE" or "NO INPUT SIGNAL" appears on the screen, see "Warning Messages" on page 18.

For customers using Windows 95

Install the new model information from the "Windows 95 Monitor Information Disk" into your PC. (Refer to the attached Windows 95 Monitor Information Disk manual.)

This monitor complies with the "VESA DDC" Plug&Play standard. If your PC/graphics board complies with DDC, select "Plug and Play Monitor (VESA DDC)" as "Monitor type" from "Control Panel" in Windows 95. Some PCs/graphics boards do not comply with DDC. Even if your computer complies with DDC, it may have some problems connecting with this monitor. In this case, select this monitor's model name (CPD-100GS or CPD-200GS) as "Monitor type" in Windows 95.

Selecting the On-screen Display Language

If you need to change the OSD language, see "Selecting the on-screen display language" on page 15. The default setting is English.

Connecting Your Monitor's Speaker

You can listen to music, sounds, and other audio files using the speaker in your monitor.

Connect the AUDIO IN jack to the audio out jack of your computer's sound card using the miniplug cord (supplied).

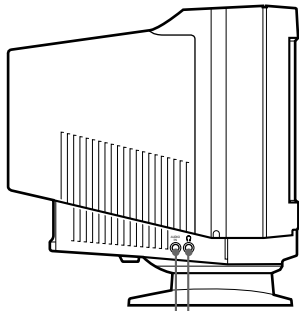

AUDIO IN jack Headphones jack

Adjusting the sound

1 Press the MENU button.

The MENU OSD appears.

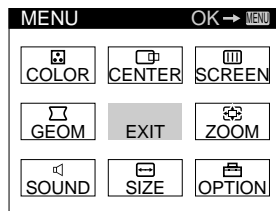

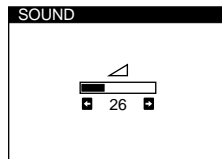
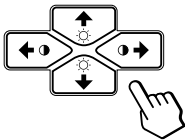

2 Press the and buttons to select "SOUND," and press the MENU button again.

The SOUND OSD appears.



Note

While muting the sound, the  mark appears in the SOUND OSD instead of the  mark. Increase the volume to cancel the  mark and activate the speaker.

3 Press the buttons to adjust the volume.

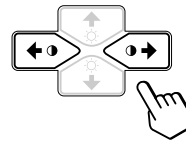

The OSD automatically disappears after about 30 seconds. To close the OSD, press the MENU button again.

To reset, press the RESET button while the OSD is on.

To mute the sound

Press the MUTING button.

No sound comes from the speaker.

The  mark appears at the bottom of the screen.



To cancel, press the MUTING button again.

Using the headphones jack

You can listen to the audio signals from your computer using headphones (not supplied). The speaker turns off when headphones are connected to the headphones jack. Adjust the volume using the SOUND OSD.

Note

If the volume from the speaker is too low, increase the output level (average of 500 mv) of the computer.

Before adjusting

- Connect the monitor and the computer, and turn them on.
- Select "A (LANGUAGE)" in the OPTION OSD, then select "ENG" (English) (see page 15).

Adjusting the Picture Brightness and Contrast

Once the setting is adjusted, it will be stored in memory for all input signals received.

- 1 Press the ☀ (brightness) ↓/↑ or ⦿ (contrast) ←/→ buttons.

The BRIGHTNESS/CONTRAST OSD appears.

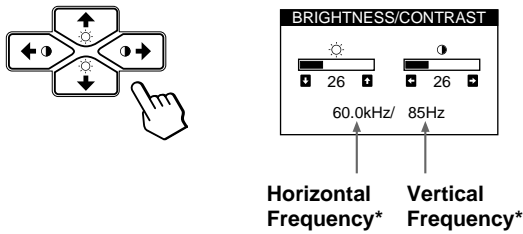

- 2 For brightness adjustment

Press the ☀ ↓/↑ buttons.

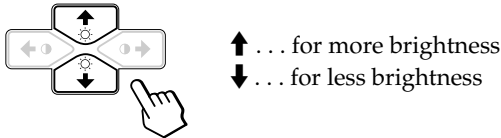

For contrast adjustment

Press the ⦿ ←/→ buttons.

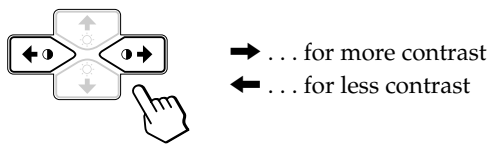

The OSD automatically disappears after about 3 seconds.

To reset, press the RESET button while the OSD is on. The brightness and contrast are both reset to the factory settings.

* The horizontal and vertical frequencies for the received input signal appear in the BRIGHTNESS/CONTRAST OSD.

Introducing the On-screen Display System

Most adjustments are made using the MENU OSD.

MENU OSD

Press the MENU button to display the MENU OSD.

This MENU OSD contains links to the other OSDs described below.

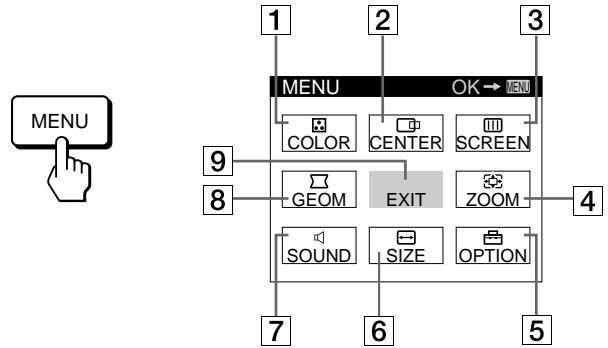

- 1 **COLOR**
Displays the COLOR OSD for adjusting the color temperature.
- 2 **CENTER**
Displays the CENTER OSD for adjusting the centering of the picture.
- 3 **SCREEN**
Displays the SCREEN OSD for adjusting the vertical and horizontal convergence, etc.
- 4 **ZOOM**
Displays the ZOOM OSD for enlarging and reducing the picture.
- 5 **OPTION**
Displays the OPTION OSD for adjusting the OSD position, degaussing the screen, selecting the OSD language, etc.
- 6 **SIZE**
Displays the SIZE OSD for adjusting the picture size.
- 7 **SOUND**
Displays the SOUND OSD for adjusting the sound.
- 8 **GEOM**
Displays the GEOMETRY OSD for adjusting the picture rotation and pincushion, etc.
- 9 **EXIT**
Closes the MENU OSD.

Using the CENTER On-screen Display

The CENTER settings allow you to adjust the centering of the picture.

Once the setting is adjusted, it will be stored in memory for the current input signal.

1 Press the MENU button.

The MENU OSD appears.



2 Press the and buttons to select "CENTER," and press the MENU button again.

The CENTER OSD appears.

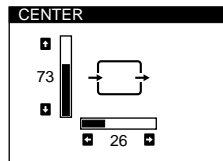
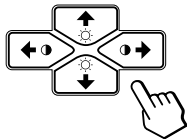

3 For horizontal adjustment

Press the buttons.

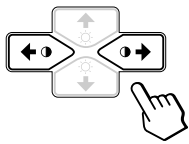

... to move the picture right
 ... to move the picture left

For vertical adjustment

Press the buttons.

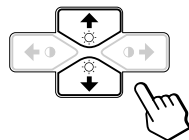

... to move the picture up
 ... to move the picture down

The OSD automatically disappears after about 30 seconds. To close the OSD, press the MENU button again.

To reset, press the RESET button while the OSD is on. The horizontal and vertical centerings are both reset to the factory settings.

Using the SIZE On-screen Display

The SIZE settings allow you to adjust the size of the picture. Once the setting is adjusted, it will be stored in memory for the current input signal.

1 Press the MENU button.

The MENU OSD appears.



2 Press the and buttons to select "SIZE," and press the MENU button again.

The SIZE OSD appears.

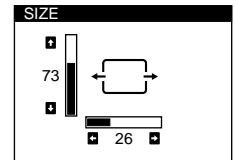
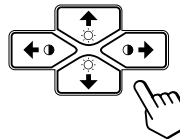

3 For horizontal adjustment

Press the buttons.

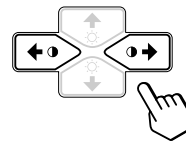

... to increase picture size
 ... to decrease picture size

For vertical adjustment

Press the buttons.

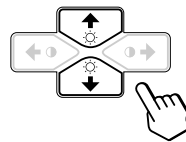

... to increase picture size
 ... to decrease picture size

The OSD automatically disappears after about 30 seconds. To close the OSD, press the MENU button again.

To reset, press the RESET button while the OSD is on. The horizontal and vertical sizes are both reset to the factory settings.

Using the GEOM (Geometry) On-screen Display

The GEOM (geometry) settings allow you to adjust the shape and orientation of the picture. Once the rotation is adjusted, it will be stored in memory for all input signals received. All other adjustments will be stored in memory for the current input signal.

1 Press the MENU button.

The MENU OSD appears.



2 Press the and buttons to select "GEOM," and press the MENU button again.

The GEOMETRY OSD appears.

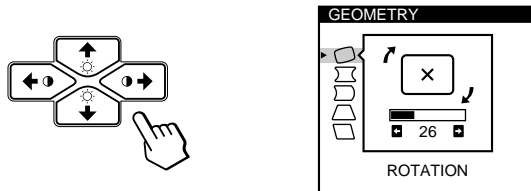

3 Press the buttons to select the item you want to adjust.

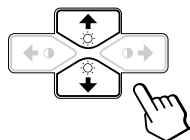

Select	To
ROTATION	adjust the picture rotation
PINCUSHION	adjust the picture sides
PIN BALANCE	adjust the picture side balance
KEYSTONE	adjust the picture width
KEY BALANCE	adjust the picture shape balance

4 Press the buttons to adjust the settings.

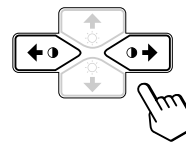

For	Press
ROTATION	<p> ... to rotate the picture clockwise</p> <p> ... to rotate the picture counterclockwise</p>
PINCUSHION	<p> ... to expand the picture sides</p> <p> ... to contract the picture sides</p>
PIN BALANCE	<p> ... to move the picture sides to the right</p> <p> ... to move the picture sides to the left</p>
KEYSTONE	<p> ... to increase the picture width at the top</p> <p> ... to decrease the picture width at the top</p>
KEY BALANCE	<p> ... to move the top of the picture to the right</p> <p> ... to move the top of the picture to the left</p>

The OSD automatically disappears after about 30 seconds. To close the OSD, press the MENU button again.

To reset, press the RESET button while the OSD is on. The selected item is reset to the factory setting.

Using the ZOOM On-screen Display

The ZOOM settings allow you to enlarge or reduce the picture. Once the setting is adjusted, it will be stored in memory for the current input signal.

- 1 Press the **MENU** button.
The MENU OSD appears.



- 2 Press the **☀↓/↑** and **◀/▶** buttons to select "ZOOM," and press the **MENU** button again.
The ZOOM OSD appears.

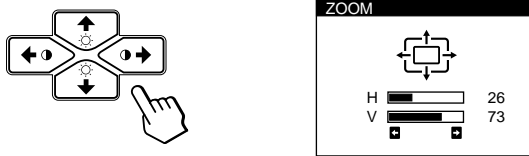

- 3 Press the **◀/▶** buttons to adjust the picture zoom.

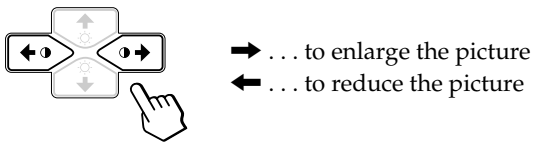

The OSD automatically disappears after about 30 seconds. To close the OSD, press the **MENU** button again.

To reset, press the **RESET** button while the OSD is on.

Note

The picture zoom adjustment will stop as soon as either the horizontal or vertical size reaches its maximum or minimum value.

Using the COLOR On-screen Display

You can change the monitor's color temperature. For example, you can change the colors of a picture on the screen to match the actual colors of the printed picture. Once the setting is adjusted, it will be stored in memory for all input signals received.

- 1 Press the **MENU** button.
The MENU OSD appears.



- 2 Press the **☀↓/↑** and **◀/▶** buttons to select "COLOR," and press the **MENU** button again.
The COLOR OSD appears.



If you are using Graphic Picture Enhancement (GPE)

If you are in one of the GPE modes, the following COLOR OSD appears when "COLOR" is selected.

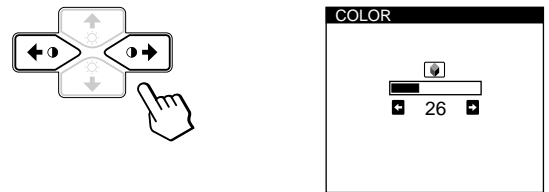

This OSD allows you to reduce the color temperature from 11,000K to 9,300K. Press the **◀/▶** buttons to adjust the color temperature.

For more information on using GPE, see "Selecting the Graphic Picture Enhancement (GPE) Mode" on page 16.

(continued)

- 3 Press the buttons to select the color temperature.

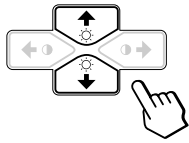

There are two color temperature modes in the OSD. The preset adjustments are 9,300K and 5,000K.

Selecting your own color temperature between 9,300K and 5,000K

Press the buttons to select “ (VARIABLE)” and adjust by pressing the buttons.

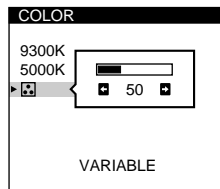
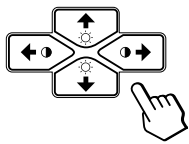

- ➔ ... for a higher temperature (bluish)
- ➜ ... for a lower temperature (reddish)

The OSD automatically disappears after about 30 seconds. To close the OSD, press the MENU button again.

To reset, press the RESET button while the OSD is on. The selected color temperature is reset to the factory settings.

Using the SCREEN On-screen Display

Adjust convergence settings to eliminate red or blue shadows that may appear around objects on the screen. Adjust the CANCEL MOIRE function to eliminate wavy or elliptical lines that may appear on the screen. Once the setting is adjusted, it will be stored in memory for all input signals received.

- 1 Press the MENU button.

The MENU OSD appears.



- 2 Press the and buttons to select “ SCREEN,” and press the MENU button again.

The SCREEN OSD appears.

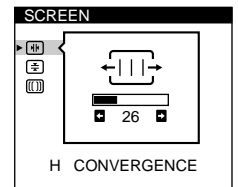
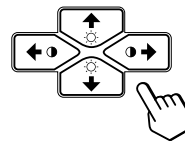

- 3 Press the buttons to select the item you want to adjust.

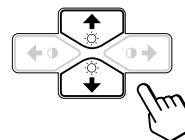







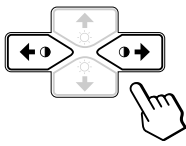





Select	To
H CONVERGENCE	adjust the horizontal convergence
V CONVERGENCE	adjust the vertical convergence
CANCEL MOIRE	eliminate elliptical or wavy lines on the screen
* MOIRE ADJUST	adjust the degree of moire cancellation

* CANCEL MOIRE must be “ON” for “ (MOIRE ADJUST)” to appear on the screen.

4 Press the  buttons to adjust the settings.



For	Press
 H CONVERGENCE	<p>→ ... to shift red shadows to the right and blue shadows to the left</p>  <p>← ... to shift red shadows to the left and blue shadows to the right</p> 
 V CONVERGENCE	<p>→ ... to shift red shadows up and blue shadows down</p>  <p>← ... to shift red shadows down and blue shadows up</p> 
 CANCEL MOIRE	<p>→ ... to turn CANCEL MOIRE "ON"</p>  <p>← ... to turn CANCEL MOIRE "OFF"</p> 
 MOIRE ADJUST	<p>→ ... to increase the moire cancellation effect</p>  <p>← ... to decrease the moire cancellation effect</p> 

The OSD automatically disappears after about 30 seconds. To close the OSD, press the MENU button again.

To reset, press the RESET button while the OSD is on. The selected item is reset to the factory setting.

Using the OPTION On-screen Display

The OPTION OSD allows you to manually degauss the screen and adjust settings such as the OSD position and OSD language. It also allows you to lock the controls.





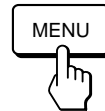

Degaussing the screen

The monitor screen is automatically degaussed (demagnetized) when the power is turned on. You can also manually degauss the monitor.

1 Press the **MENU** button.

The MENU OSD appears.



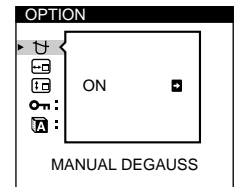
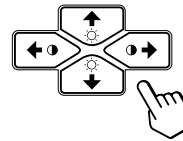

2 Press the   /  and  /  buttons to select "  **OPTION,**" and press the MENU button again.

The OPTION OSD appears.

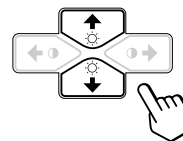

3 Press the   /  buttons to select "  (**MANUAL DEGAUSS**)."



4 Press the  button.

The screen is degaussed for about 5 seconds.

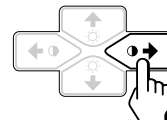

If you need to degauss the screen a second time, wait for at least 20 minutes before repeating the steps above.

The OPTION OSD automatically disappears after about 30 seconds.

To close the OSD, press the MENU button again.

Customizing Your Monitor

Changing the on-screen display position



You can change the OSD position (for example, when you want to adjust the picture behind the OSD).

- 1 Press the **MENU** button.
The MENU OSD appears.

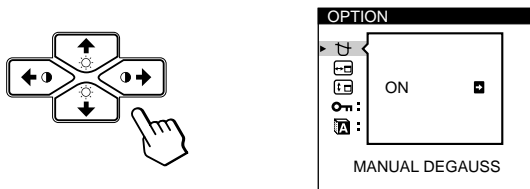

- 2 Press the **☼↓/↑** and **⦿←/→** buttons to select "  **OPTION,"** and press the MENU button again.
The OPTION OSD appears.



- 3 Press the **☼↓/↑** buttons to select "  **(OSD H POSITION)"** or "  **(OSD V POSITION)."'**
Select "  **(OSD H POSITION)"** to adjust the horizontal position.

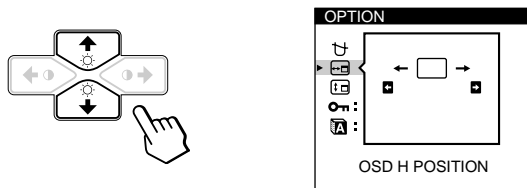

Select "  **(OSD V POSITION)"** to adjust the vertical position.

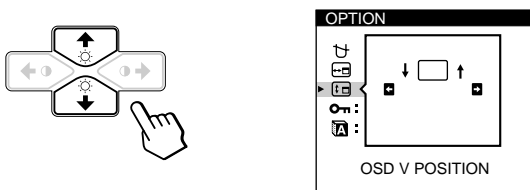

- 4 Press the **⦿←/→** buttons to move the OSD to the desired position.

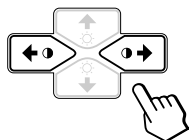

The OPTION OSD automatically disappears after about 30 seconds.

To close the OSD, press the MENU button again.

To reset, press the RESET button while the OSD is on.

Locking the controls

The control lock function disables all of the buttons on the front panel except the  (power) switch and MENU button.

- 1 Press the **MENU** button.
The MENU OSD appears.

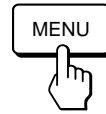

- 2 Press the **☼↓/↑** and **⦿←/→** buttons to select "  **OPTION,"** and press the MENU button again.
The OPTION OSD appears.

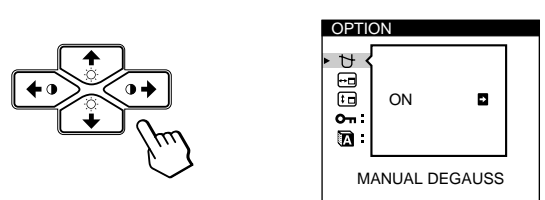

- 3 Press the **☼↓/↑** buttons to select "  **(CONTROL LOCK)."'**

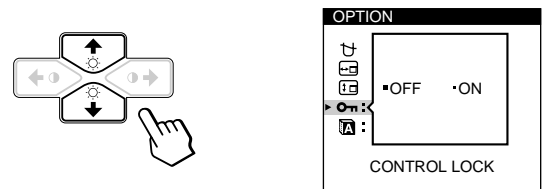

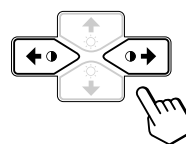

- 4 Press the **⦿←/→** buttons to select "ON."



The OPTION OSD automatically disappears after about 30 seconds.

To close the OSD, press the MENU button again.

Once you select "ON," you cannot select any items except "EXIT" and "  OPTION" in the MENU OSD.

If you press any button other than the  (power) switch and MENU button, the  mark appears on the screen.

To cancel the control lock

Repeat steps 1 through 3 above and press the **⦿←/→** buttons to select "OFF."

Selecting the on-screen display language

English, French, German, Spanish and Japanese versions of the OSDs are available.

- 1 Press the **MENU** button.
The MENU OSD appears.



- 2 Press the **↑/↓** and **←/→** buttons to select "OPTION," and press the MENU button again.
The OPTION OSD appears.

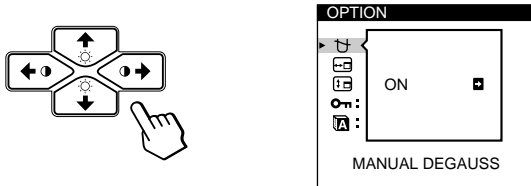

- 3 Press the **↑/↓** buttons to select "A (LANGUAGE)."

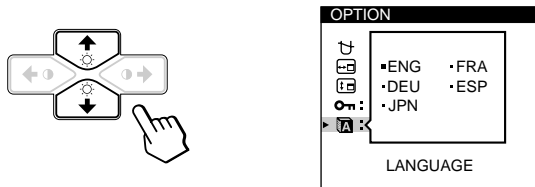

- 4 Press the **←/→** buttons to select the desired language.

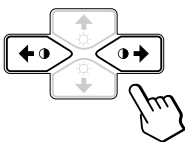

ENG: English, FRA: French, DEU: German, ESP: Spanish, or JPN: Japanese.

The OPTION OSD automatically disappears after about 30 seconds.

To close the OSD, press the MENU button again.

To reset to English, press the RESET button while the OSD is on.

Resetting the Adjustments

Resetting an adjustment item

- 1 Press the **MENU**, **↑/↓** and **←/→** buttons to select the OSD containing the item you want to reset.

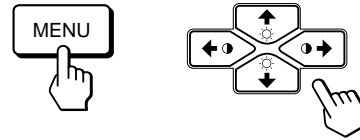

- 2 Press the **↑/↓** buttons to select the item you want to reset.

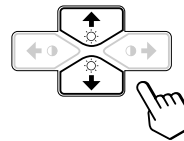

- 3 Press the **RESET** button.



Resetting all of the adjustment data for the current input signal

When there is no OSD displayed, press the **RESET** button.

All of the adjustments data for the current input signal is reset to the factory settings.

Note that adjustment data not affected by changes in input signal (OSD language, OSD position and the control lock function) is not reset to the factory settings.



Resetting all of the adjustment data for all input signals

Press and hold the **RESET** button for more than two seconds.

All of the adjustment data, including the brightness and contrast, is reset to the factory settings.



Selecting the Graphic Picture Enhancement (GPE) Mode

The Graphic Picture Enhancement (GPE) button allows you to automatically change the characteristics of the picture on the screen to match the use of your monitor. Simply press the GPE button to scroll between the three modes.

- 1 Turn on the monitor and computer.
- 2 Press the GPE button to set the mode.



Each time you press the GPE button, the mode appears on the screen and changes as follows.

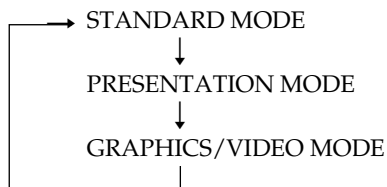

The STANDARD MODE is ideal for spreadsheets, word processing, and other text oriented applications.

The PRESENTATION MODE is useful for presentation programs that require vivid colors.

The GRAPHICS/VIDEO MODE gives movies and games enhanced visual appeal by increasing the sharpness and brightness.

The selected mode indication appears on the screen for about 3 seconds.

If the screen appears too white, adjust the color temperature as explained in “Using the COLOR On-screen Display” on page 11.

Note

The PRESENTATION MODE and GRAPHICS/VIDEO MODE may produce ghost images when displaying text oriented applications. These modes change the brightness of the picture dynamically according to changes in moving pictures. If ghost images appear, set the GPE to STANDARD MODE.

Preset and User Modes

The monitor has factory preset modes for the 9 (CPD-100GS) or 10 (CPD-200GS) most popular industry standards for true “plug and play” capability.

Recommended horizontal and vertical timing conditions

Horizontal sync width duty should be 1.0 μsec of total horizontal time.

Horizontal blanking width should be ≥3.0 μsec for CPD-200GS.

Horizontal blanking width should be ≥3.6 μsec for CPD-100GS.

Vertical blanking width should be ≥500 μsec for both CPD-100GS and CPD-200GS.

Note for Windows® users

For Windows users, check your video board manual or the utility program which comes with your graphic board and select the highest available refresh rate to maximize monitor performance.

CPD-100GS

No.	Resolution (dots × lines)	Horizontal Frequency	Vertical Frequency	Graphics Mode
1	640 × 480	31.5 kHz	60 Hz	VGA Graphic
2	640 × 480	43.3 kHz	85 Hz	VESA
3	720 × 400	31.5 kHz	70 Hz	VGA Text
4	800 × 600	46.9 kHz	75 Hz	VESA
5	800 × 600	53.7 kHz	85 Hz	VESA
6	832 × 624	49.7 kHz	75 Hz	Macintosh 16" Color
7	1024 × 768	60.0 kHz	75 Hz	VESA
8	1024 × 768	68.7 kHz	85 Hz	VESA
9	1280 × 1024	64.0 kHz	60 Hz	VESA

CPD-200GS

No.	Resolution (dots × lines)	Horizontal Frequency	Vertical Frequency	Graphics Mode
1	640 × 480	31.5 kHz	60 Hz	VGA Graphic
2	640 × 480	43.3 kHz	85 Hz	VESA
3	720 × 400	31.5 kHz	70 Hz	VGA Text
4	800 × 600	46.9 kHz	75 Hz	VESA
5	800 × 600	53.7 kHz	85 Hz	VESA
6	832 × 624	49.7 kHz	75 Hz	Macintosh 16" Color
7	1024 × 768	60.0 kHz	75 Hz	VESA
8	1024 × 768	60.2 kHz	75 Hz	Macintosh 19" Color
9	1024 × 768	68.7 kHz	85 Hz	VESA
10	1280 × 1024	80.0 kHz	75 Hz	VESA

Displaying the monitor's information

You can display the model name, serial number and year of manufacture using the monitor's INFORMATION OSD.

Press and hold the MENU button for 5 seconds.

The INFORMATION OSD appears.

Example:

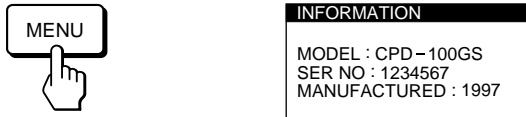

The INFORMATION OSD includes the model name, serial number and manufactured year.

The OSD automatically disappears after about 30 seconds.

Power Saving Function

This monitor has three modes of reduced power consumption. By sensing the absence of video signal coming from the computer, it reduces power consumption as follows.

	Power consumption mode	Power consumption	Recovery time	⏻ indicator
1	Normal operation	≤ 120 W (CPD-200GS) ≤ 110 W (CPD-100GS)	—	Green
2	Standby (1st mode)	≤ 15 W	Approx. 5 sec.	Green and orange alternate
3	Suspend (2nd mode)	≤ 15 W	Approx. 5 sec.	Green and orange alternate
4	Active-off (3rd mode)	≤ 8 W	Approx. 15 sec.	Orange
5	Power-off	0 W	—	Off

Note

If the video signal cable is not connected, the "NO INPUT SIGNAL" message (page 18) appears. After 30 seconds, the power saving function automatically puts the monitor into the active-off mode and the ⏻ indicator lights up orange. Once the horizontal and vertical sync signals are detected, the monitor automatically resumes its normal operation mode.

Damper Wires

When viewing a white background, very thin horizontal lines are visible on the screen as shown below. These lines are damper wires.

The Trinitron tube has a vertically striped aperture grille inside. The aperture grille allows more light to pass through to the screen giving the Trinitron CRT more color and brightness.

These damper wires are attached to the aperture grille to prevent vibration of the aperture grille and keep the screen image constantly stable.

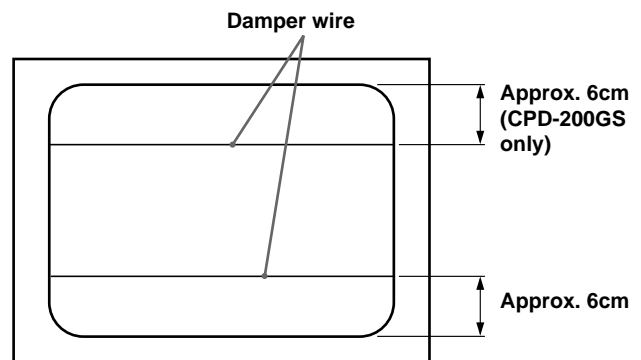

EN

Plug & Play

This monitor complies with the DDC™1 and DDC2B Display Data Channel (DDC) standards of VESA. When a DDC1 host system is connected, the monitor synchronizes with the V. CLK in accordance with the VESA standards and outputs the EDID (Extended Display Identification Data) to the data line. When a DDC2B host system is connected, the monitor automatically switches to the appropriate standard.

DDC™ is a trademark of the Video Electronics Standard Association.

Warning Messages

If there is something wrong with the input signal, one of the following messages appears.

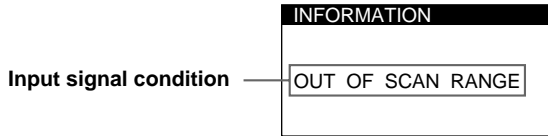

The input signal condition

“OUT OF SCAN RANGE” indicates that the input signal is not supported by the monitor’s specifications.

“NO INPUT SIGNAL” indicates that no signal is input.

To solve these problems, see “Troubleshooting” below.

Troubleshooting

This section may help you isolate the cause of a problem and as a result, eliminate the need to contact technical support.

Symptom	Check these items
No picture	
If the ⏻ indicator is not lit	<ul style="list-style-type: none"> • Check that the power cord is properly connected. • Check that the ⏻ (power) switch is in the “on” position.
If the “NO INPUT SIGNAL” message appears on the screen, or if the ⏻ indicator is either orange or alternating between green and orange	<ul style="list-style-type: none"> • Try pressing any key on the computer keyboard. • Check that your computer power switch is in the “on” position. • Check that the video signal cable is properly connected and all plugs are firmly seated in their sockets. • Ensure that no pins are bent or pushed in the HD15 video input connector. • Check that the video board is completely seated in the proper bus slot.
If the “OUT OF SCAN RANGE” message appears on the screen	<ul style="list-style-type: none"> • Check that the video frequency range is within that specified for the monitor. Horizontal: 30 – 70 kHz (CPD-100GS), 30 – 85 kHz (CPD-200GS) Vertical: 50 – 120 Hz Refer to your computer’s instruction manual to adjust the video frequency range. • If you are using a video signal cable adapter, check that it is the correct one.
If no message is displayed and the ⏻ indicator is green or flashing orange	<ul style="list-style-type: none"> • See “Self-diagnosis Function” (page 20).
Picture is scrambled	<ul style="list-style-type: none"> • Check your graphics board manual for the proper monitor setting. • Check this manual and confirm that the graphics mode and the frequency you are trying to operate at is supported. Even if the frequency is within the proper range, some video boards may have a sync pulse that is too narrow for the monitor to sync correctly.
Color is not uniform	<ul style="list-style-type: none"> • Degauss the monitor (page 13). If you place equipment which generates a magnetic field, such as a loudspeaker, near the monitor, or you change the direction of the monitor, color may lose uniformity. The degauss function demagnetizes the metal frame of the CRT to obtain a neutral field for uniform color reproduction. If a second degauss cycle is needed, allow a minimum interval of 20 minutes for the best result.
You cannot adjust the monitor with the buttons on the front panel	<ul style="list-style-type: none"> • If the control lock function is set to on, set it to off using the OPTION OSD (page 14).

Symptom	Check these items
Screen image is not centered or sized properly	<ul style="list-style-type: none"> • Adjust the size or centering (page 9). • Some video modes do not fill the screen to the edges. This problem tends to occur with certain video boards.
Edges of the image are curved	<ul style="list-style-type: none"> • Adjust the geometry (page 10).
White lines show red or blue shadows at edges	<ul style="list-style-type: none"> • Adjust the convergence (pages 12 – 13).
Picture is fuzzy	<ul style="list-style-type: none"> • Adjust the contrast and brightness (page 8). • Degauss the monitor (page 13). If you place equipment which generates a magnetic field, such as a loudspeaker, near the monitor, or you change the direction of the monitor, color may lose uniformity. The degauss function demagnetizes the metal frame of the CRT to obtain a neutral field for uniform color reproduction. If a second degauss cycle is needed, allow a minimum interval of 20 minutes for the best result. • If red or blue shadows appear along the edges of images, adjust the convergence (pages 12 – 13). • If the moire is cancelled, the picture may become fuzzy. Decrease the moire cancellation effect (pages 12 – 13).
Picture bounces or has wavy oscillations	<ul style="list-style-type: none"> • Isolate and eliminate any potential sources of electric or magnetic fields. Common causes for this symptom are electric fans, fluorescent lighting or laser printers. • If you have another monitor close to this monitor, increase the distance between them to reduce the interference. • Try plugging the monitor into a different AC outlet, preferably on a different circuit. • Try the monitor on a different computer in a different room.
Picture is flickering	<ul style="list-style-type: none"> • Set the refresh rate on the computer to obtain the best possible picture by referring to your computer's manual.
Picture appears to be ghosting	<ul style="list-style-type: none"> • Eliminate the use of video cable extensions and/or video switch boxes if this symptom occurs. Excessive cable length or a weak connection can produce this symptom.
Wavy or elliptical (moire) pattern is visible	<ul style="list-style-type: none"> • Cancel the moire (pages 12 – 13). The moire may be modified depending on the connected computer. • Due to the relationship between resolution, monitor dot pitch and the pitch of some image patterns, certain screen backgrounds sometimes show moire. Change your desktop pattern.
Two fine horizontal lines (wires) are visible	<ul style="list-style-type: none"> • These wires stabilize the vertically striped aperture grille (page 17). This aperture grille allows more light to pass through to the screen giving the Trinitron CRT more color and brightness.
Hum is heard right after the power is turned on	<ul style="list-style-type: none"> • When the power is turned on, the auto-degauss cycle is activated. While the auto-degauss cycle is activated, a hum may be heard. The same hum is heard when the monitor is manually degaussed. This is not a malfunction.

- If the problem persists, call your authorized Sony dealer from a location near your monitor.
- Note the model name and the serial number of your monitor. Also note the make and name of your video board.

Self-diagnosis Function

This monitor is equipped with a self-diagnosis function. Use this function if there is a problem with your monitor or computer.

- 1 **Disconnect the video input cable or turn off the connected computer.**
- 2 **Turn the monitor off and on.**
- 3 **Press and hold the  button for 2 seconds.**

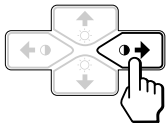

If all four color bars appear (white, red, green, blue) after a few seconds, the monitor is working properly but there might be a problem with your computer. Contact your computer's manufacturer.

If the color bars do not appear, there is a potential monitor failure. Inform your authorized Sony dealer of the monitor's condition.

Specifications

CPD-100GS

Picture tube	0.25 mm aperture grille pitch 15 inches measured diagonally 90-degree deflection
Viewable image size	Approx. 285 × 214 mm (w/h) (11 1/4 × 8 1/2 inches) 14.0" viewing image
Resolution	Horizontal: Max. 1280 dots Vertical: Max. 1024 lines
Standard image area	Approx. 270 × 202 mm (w/h) (10 3/4 × 8 inches) or Approx. 253 × 202 mm (w/h) (10 × 8 inches)
Deflection frequency	Horizontal: 30 to 70 kHz Vertical: 50 to 120 Hz
Audio output	0.5W (mono)
Headphones jack	Stereo minijack Accepts impedance of 8 Ω or more
AUDIO IN jack	Stereo minijack
AC input voltage/current	100 to 240 V, 50 – 60 Hz, 1.8 – 1.0 A
Power consumption	Max. 110 W
Dimensions	368 × 392 × 384.5 mm (w/h/d) (14 1/2 × 15 1/2 × 15 1/4 inches)
Mass	Approx. 14 kg (30 lb 14 oz)
Supplied accessories	See page 6

CPD-200GS

Picture tube	0.25 mm aperture grille pitch 17 inches measured diagonally 90-degree deflection
Viewable image size	Approx. 327 × 243 mm (w/h) (12 7/8 × 9 5/8 inches) 16.0" viewing image
Resolution	Horizontal: Max. 1280 dots Vertical: Max. 1024 lines
Standard image area	Approx. 312 × 234 mm (w/h) (12 3/8 × 9 1/4 inches) or Approx. 293 × 234 mm (w/h) (11 5/8 × 9 1/4 inches)
Deflection frequency	Horizontal: 30 to 85 kHz Vertical: 50 to 120 Hz
Audio output	0.5W (mono)
Headphones jack	Stereo minijack Accepts impedance of 8 Ω or more
AUDIO IN jack	Stereo minijack
AC input voltage/current	100 to 240 V, 50 – 60 Hz, 1.9 – 1.1 A
Power consumption	Max. 120 W
Dimensions	406 × 432 × 420 mm (w/h/d) (16 × 17 1/8 × 16 5/8 inches)
Mass	Approx. 18 kg (39 lb 11 oz)
Supplied accessories	See page 6

Design and specifications are subject to change without notice.

