

# COBY®

2.4" LCD High-Resolution  
MP3 and Video Player



MP-805



## Instruction Manual

Please read this manual carefully before operation

# Precautions

	<b>CAUTION</b> WARNING: SHOCK HAZARD, DO NOT OPEN. AVIS: RISQUE DE CHOC ELECTRIQUE. NE PAS OUVRIIR	
<b>CAUTION:</b> TO REDUCE THE RISK OF FIRE AND ELECTRIC SHOCK, DO NOT REMOVE THE COVER (OR BACK) OF THE UNIT. REFER SERVICING ONLY TO QUALIFIED SERVICE PERSONNEL.		



The lightning flash with arrowhead symbol within an equilateral triangle is intended to alert the user to the presence of uninsulated "dangerous voltage" within the product's enclosure that may be of sufficient magnitude to constitute a risk of electric shock.



The exclamation point within an equilateral triangle is intended to alert the user to the presence of important operation and servicing instructions in the literature accompanying the appliance.

#### **For Customer Use:**

Enter below the serial number that is located on the unit. Retain this information for future reference.

**Model No.** \_\_\_\_\_

**Serial No.** \_\_\_\_\_

#### **WARNING:**

To prevent fire or shock hazard, do not expose this device to rain or moisture. Dangerous high voltage is present inside the enclosure. Do not open the cabinet.

#### **CAUTION:**

To prevent electric shock, match wide blade of plug to wide slot of outlet and fully insert.

#### **WARNING:**

Handling the cords on this product will expose you to lead, a chemical known to the State of California to cause cancer, and birth defects or other reproductive harm. **Wash hands after handling.**



For recycling or disposal information about this product, please contact your local authorities or the Electronics Industries Alliance: [www.eiae.org](http://www.eiae.org).

# Precautions

## **PROTECT YOUR HEARING:**

Hearing experts advise against the constant use of personal stereos played at high volume. Constant exposure to high volumes can lead to hearing loss. If you should experience ringing in the ears or hearing loss, discontinue use and seek medical advice.

## **FCC Notice:**

This equipment has been tested and found to comply with the limits for a Class B digital device pursuant to Part 15 of the FCC Rules. These limits are designed to provide reasonable protection against harmful interference in a residential installation. This equipment generates, uses, and can radiate radio frequency energy and, if not installed and used in accordance with the instructions, may cause harmful interference to radio or television reception. However, there is no guarantee that interference will not occur in a particular installation. If this equipment does cause harmful interference to radio or television reception (which can be determined by turning the equipment off and on), the user is encouraged to try and correct the interference by one or more of the following measures:

- Reorient or relocate the receiving antenna.
- Increase the separation between the equipment and the receiver.
- Connect the equipment into an outlet on a circuit different from that to which the receiver is connected.
- Consult the dealer or an experienced audio/TV technician for help.

## **NOTICE:**

This product is protected by certain intellectual property rights of Microsoft. Use or distribution of such technology outside of this product is prohibited without a license from Microsoft.

## **NOTICE:**

Please refer to the packaging of this product for the technologies supported by this product.

Windows Media® is a registered trademark of Microsoft Corporation.

USB® is a registered trademark of USB Implementers Forum, Inc.

The eMusic name and logo are trademarks of eMusic.com, Inc. in the United States and abroad.

All trademarks, registered trademarks and logos are of their respective holders.

# Important Safety Instructions

1. **Read Instructions:** All the safety and operating instructions should be read before the product is operated.
2. **Retain Instructions:** The safety and operating instructions should be retained for future reference.
3. **Heed Warnings:** All warnings on the product and in the operating instructions should be adhered to.
4. **Follow Instructions:** All operating and usage instructions should be followed.
5. **Cleaning:** Unplug this product from the wall outlet before cleaning. Do not use liquid cleaners or aerosol cleaners. Use a damp cloth for cleaning.
6. **Attachments:** Use only attachments recommended by the manufacturer. Use of other attachments may be hazardous.
7. **Water and Moisture:** Do not use this product near water (e.g., near a bath tub, washbowl, kitchen sink, laundry tub, in wet basements, or near a swimming pool and the like).
8. **Accessories:** Do not place this product on an unstable cart, stand, tripod, bracket, or table. Use only with carts, stands, tripods, brackets, or tables recommended by the manufacturer or sold with the product. Any mounting of the product should follow the manufacturer's instructions and should use a mounting accessory recommended by the manufacturer.



A product and cart combination should be moved with care. Quick stops, excessive force, and uneven surfaces may cause the product and cart combination to overturn.

9. **Ventilation:** Slots and openings in the cabinet are provided for ventilation to ensure reliable operation of the product and to protect it from overheating. These openings should never be blocked by placing the product on a bed, sofa, rug, or other similar surface. This product should not be placed in a built-in installation such as a bookcase or rack unless proper ventilation is provided or the manufacturer instructions have been adhered to.
10. **Power Sources:** This product should be operated only from the type of power source indicated on the rating label. If you are not sure of the type of power supply to your home, consult your product dealer or local power company. For products intended to operate from battery power or other sources, refer to the operating instructions.
11. **Grounding or Polarization:** This product may be equipped with a polarized alternating-current line plug that has one blade wider than the other. This plug will only fit into the power outlet in one direction. This is a safety feature. If you are unable to insert the plug fully into the outlet, try reversing the direction of the plug. If the plug should still fail to fit, contact an electrician to replace the obsolete outlet. Do not defeat the safety purpose of the polarized plug.

# Important Safety Instructions

12. **Power-Cord Protection:** Power supply cords should be routed so that they are not likely to be walked on or pinched by items placed upon or against them, paying particular attention to cords at plugs, convenience receptacles, and at the point which they exit from the product.
13. **Protective Attachment Plug:** The product may be equipped with an attachment plug with overload protection. This is a safety feature. See the operating instructions for replacement or directions to reset the protective device. If replacement of the plug is required, be sure the service technician has used a replacement plug that has the same overload protection as the original plug as specified by the manufacturer.
14. **Outdoor Antenna Grounding:** If an outside antenna is connected to the product, be sure the antenna system is grounded so as to provide some protection against voltage surges and built-up static charges. Article 810 of the National Electrical Code, ANS/NFPA 70 provides information with regard to proper grounding of the mast and supporting structure, grounding of the lead-in wire to an antenna-discharge unit, size of grounding conductors, location of antenna-discharge unit, connection to grounding electrodes, and requirements for the grounding electrode (see figure).

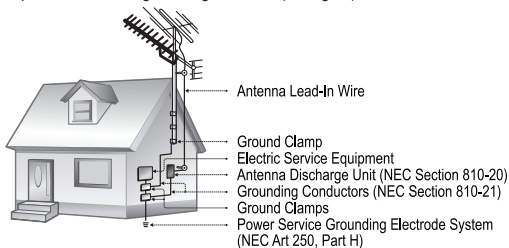

15. **Lightning:** For added protection for this product, unplug it from the wall outlet and disconnect the antenna or cable system during a lightning storm or when it is left unattended and unused for long periods of time. This will prevent damage to the product due to lightning or power-line surges.
16. **Power Lines:** An outside antenna system should not be located in the vicinity of overhead power lines or other electric light or power circuits, or where it can fall into such power lines or circuits. When installing an outside antenna system, extreme care should be taken to keep from touching such power lines or circuits, as contact with them might be fatal.
17. **Overloading:** Do not overload wall outlets, extension cords, or integral convenience receptacles as this can result in a risk of fire or electric shock.

# Important Safety Instructions

18. **Object and Liquid Entry:** Never push objects of any kind into this product through openings as they may touch dangerous voltage points or shout-out parts that could result in a fire or electric shock. Never spill liquid of any kind on the product.
19. **Servicing:** Do not attempt to service this product yourself as opening or removing covers may expose you to dangerous voltage or other hazards. Refer all servicing to qualified service personnel.
20. **Damage Requiring Service:** Unplug this product from the wall outlet and refer servicing to qualified service personnel under the following conditions: a) when the power-supply or plug is damaged; b) if liquid has been spilled or if objects have fallen into the product; c) if the product has been exposed to rain or water; d) if the product does not operate normally by following the operating instructions. Adjust only those controls that are covered by the operating instructions as improper adjustment of other controls may result in damage and will often require extensive work by a qualified technician to restore the product to its normal operation; e) if the product has been dropped or damaged in any way; f) when the product exhibits a distinct change in performance—this indicates a need for service.
21. **Replacement Parts:** When replacement parts are required, be sure that your service technician has used replacement parts specified by the manufacturer or have the same characteristics as the original part. Unauthorized substitutions may result in fire, electric shock, or other hazards.
22. **Safety Check:** Upon completion of any service or repairs to this product, ask the service technician to perform safety checks to ensure that the product is in proper operating condition.
23. **Wall or Ceiling Mounting:** The product should be mounted to a wall or ceiling only as recommended by the manufacturer.
24. **Heat:** The product should be situated away from heat sources such as radiators, heat registers, stoves, or other products (including amplifiers) that produce heat.

# Table of Contents

<b>PRECAUTIONS</b> .....	<b>2</b>
<b>IMPORTANT SAFETY INSTRUCTIONS</b> .....	<b>4</b>
<b>TABLE OF CONTENTS</b> .....	<b>7</b>
<b>PACKAGE CONTENTS</b> .....	<b>9</b>
<b>FEATURES</b> .....	<b>10</b>
<b>GETTING STARTED</b> .....	<b>11</b>
Controls at a Glance .....	11
Display at a Glance.....	12
Now Playing Screen (Music Mode).....	12
Powering Your Player.....	13
Charging Your Player .....	13
Power On/Off .....	14
Installing a miniSD Memory Card (optional) .....	14
Connecting Headphones .....	15
<b>MAIN MENU</b> .....	<b>16</b>
Main Menu Overview.....	16
<b>MUSIC MODE</b> .....	<b>17</b>
Music List.....	17
Now Playing (Music Mode) Controls.....	18
Repeat Mode .....	18
Repeat A-B Mode .....	19
<b>VIDEO MODE</b> .....	<b>20</b>
Video List .....	20
Video Playback Controls.....	20
<b>PHOTO MODE</b> .....	<b>22</b>
Photo List.....	22
Photo Controls .....	22
Displaying Pictures Manually.....	22
Displaying Pictures as a Slideshow .....	23

# Table of Contents

<b>RADIO MODE</b> .....	<b>24</b>
Basic FM Radio Operation.....	24
Radio Settings Menu.....	24
Store Presets Manually .....	25
Store Presets Automatically.....	26
Delete a Preset Station.....	26
<b>EBOOK MODE</b> .....	<b>27</b>
EBook List .....	27
EBook Controls.....	27
<b>EXPLORER MODE</b> .....	<b>28</b>
Navigator Controls.....	28
<b>SETTINGS MODE</b> .....	<b>29</b>
<b>USB CONNECTIONS</b> .....	<b>33</b>
Connecting to a Computer .....	33
Transferring Files .....	34
Microsoft Windows .....	35
Macintosh OS X .....	35
Disconnecting from a Computer .....	36
Microsoft Windows .....	36
Macintosh OS X .....	36
<b>VIDEO CONVERSION</b> .....	<b>38</b>
Installation .....	39
Converting Video .....	39
<b>WINDOWS MEDIA PLAYER</b> .....	<b>42</b>
<b>FIRMWARE UPGRADES</b> .....	<b>43</b>
<b>ABOUT MP3/WMA FILES</b> .....	<b>44</b>
<b>TROUBLESHOOTING</b> .....	<b>45</b>
<b>SPECIFICATIONS</b> .....	<b>48</b>



# Package Contents

Please make sure that the items listed below are included in the package. Should an item be missing, please contact the local retailer from which you purchased this product.

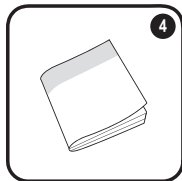
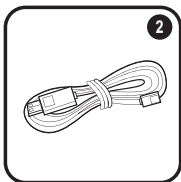

1. COBY MP3 Player
2. USB Cable
3. Stereo Earphones
4. Installation Booklet
5. Installation CD

# Features

- ✦ 2.4" TFT LCD full-color display
- ✦ Integrated flash memory
- ✦ miniSD card slot for easy memory capacity upgrades (miniSD card not included)
- ✦ Plays music, video\*, photos, and text
- ✦ Plays digital music from most online stores and subscription services\*\*
- ✦ Integrated FM radio
- ✦ ID3 tag support for song information display
- ✦ USB 2.0 Hi-Speed for fast file transfers
- ✦ Integrated rechargeable battery

\* Video playback on device may require transcoding with included software.

\*\* Music Service must support Windows Media DRM (WMDRM). WMDRM10 requires Windows XP and Windows Media Player 10 or newer.

# Getting Started

## Controls at a Glance

- |                              |   |                               |   |
|------------------------------|---|-------------------------------|---|
| 1. Headphone Jack            |   | 7. Navigation: Right Next/Fwd |  |
| 2. Play/Pause                |  | 8. Menu                       |  |
| 3. Navigation: Up Volume -   |  | 9. USB Port                   |   |
| 4. Navigation: Down Volume + |  | 10. Power Switch              |   |
| 5. A-B Repeat                |   | 11. Neckstrap Hook            |   |
| 6. Navigation: Left Prev/Rev |  | 12. miniSD Card Slot          |   |
|                              |   | 13. LCD Display               |   |

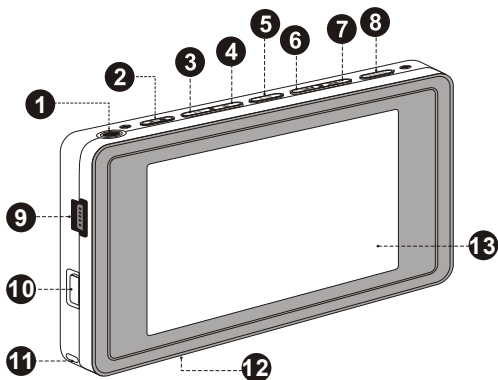

# Getting Started

## Display at a Glance

### Now Playing Screen (Music Mode)

1. Bit Rate
2. Current Track / Total Tracks
3. ID3 & LRC Info
4. Elapsed Time
5. Progress Bar
6. Play Status:  
Play ▶  
Pause ||  
Stop ■
7. A-B Repeat
8. Battery Level
9. Equalizer
10. Repeat Mode
11. Shuffle Mode
12. Volume Level
13. Remaining Time

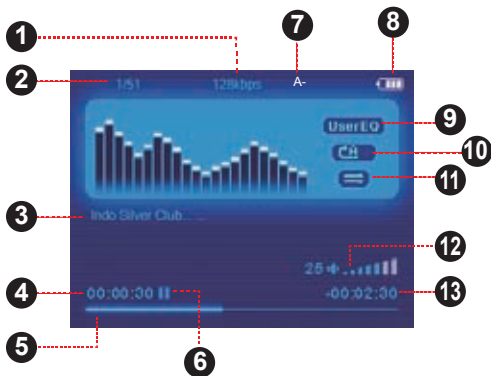

# Getting Started

## Powering Your Player

Your player has an integrated rechargeable battery that will provide up to 8 hours of music play time.



*The battery should be charged fully before its initial use to ensure optimum lifetime performance.*

*Music play time is an estimated value. Actual play time may vary depending on encoding method used and other factors.*

## Charging Your Player

Your player can be charged through a PC USB connection. Plug one end of the USB cable into the player's USB Port and plug the other end into the USB port of a powered-on computer.



*Ensure that the Power Switch is set to the "ON" position, otherwise the unit will not charge.*

*When connected to a USB hub, the hub must be self-powered to charge the player's battery.*





*The battery used in this device may present a fire or chemical burn if mistreated. Do not disassemble, incinerate, or heat the battery.*

*Do not connect the player to a power source other than that which is indicated here or on the label as this may result in the risk of fire or electric shock.*

# Getting Started

## Power On/Off

- ✦ To turn the player on, set the Power switch to the ON position, and then press and hold .
- ✦ To place the player in standby mode, press and hold  again.
- ✦ To turn the player off completely, set the Power switch to the OFF position.

## Installing a miniSD Memory Card (optional)

You can upgrade the memory capacity of your player by adding a miniSD memory card.

- ✦ Insert a miniSD card into the slot as shown in the illustration below.
- ✦ This player supports memory cards up to 2GB in size.

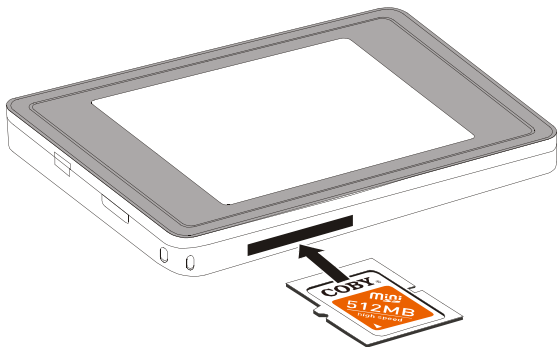

# Getting Started

## Connecting Headphones

Connect headphones or earphones to the Headphone Out jack for private listening.



*Lower the volume level before connecting headphones, then gradually increase the volume for comfortable listening.*

*Hearing experts advise against the constant use of personal stereos played at high volume.*

*Constant high-volume use can lead to hearing loss. If you experience ringing in your ears or hearing loss, discontinue use immediately and seek medical advice.*

# Main Menu

## Main Menu Overview

The Main Menu gives you access to the different function modes of your player. When your player is powered on, it will enter the Main Menu automatically.

The main menu consists of 9 items: Music, Video, Radio, Photo, Text, Explorer, and Settings.

- ✦ To return to the Main Menu at any time, press and hold **MENU**.
- ✦ To select a mode, press **◀◀** or **▶▶** to highlight the mode and then press **▶/□**.

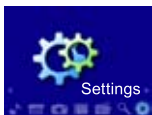
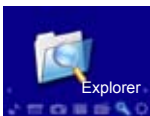
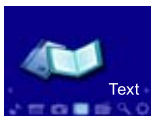
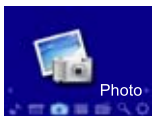
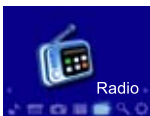



# Music Mode

**Enter MUSIC mode from the Main Menu to play digital MP3, WMA or WAV audio files.**



*For more information about how to get music onto your player, please refer to the section “USB Connections > Transferring Files”.*

*For more information about digital MP3 and WMA music files, please refer to the section “About MP3/WMA Music Files”.*

## **Music List**

Use the Music List to view all compatible music tracks loaded on your player. Press **MENU** while in MUSIC mode to view the Music List.

- ✦ Press **+** to move the selection down; press **-** to move the selection up.
- ✦ Press **▶/□** to enter a folder or to play a selection. Press **◀◀** to return to the previous screen.
- ✦ Press and hold **MENU** to cancel and return to the Main Menu.













*Press **MENU** to toggle between the Music List and Now Playing screens.*

# Music Mode

## Now Playing (Music Mode) Controls

Use the following controls during music playback (Now Playing).

Key	Function
Press 	Start/Resume track playback. During playback, press  to pause playback.
Press 	Play the next track.
Hold 	Fast-forward through the current track.
Press 	Play the previous track.
Hold 	Reverse through the current track.
Press 	Decrease the volume level.
Press 	Increase the volume level.
Press 	Toggle between the Music List and Now Playing screens.
Hold 	Return to Main Menu.

## Repeat Mode

Adjust the Repeat Mode settings to change the repeat playback options. The Repeat Mode options are: Once, Repeat One, Folder Once, All Once, All Repeat and Intro.



*Please refer to the “Settings Mode > Music > Repeat Mode” section to set the Repeat Mode options.*

# Music Mode

Item	Description
Once	Play the current track once.
Repeat One	Play the current track repeatedly.
Folder Once	Play all tracks in the current folder once.
Folder Repeat	Play all tracks in the current folder repeatedly.
All Once	Play all tracks once.
All Repeat	Play all tracks repeatedly.
Intro	Play the first 10 seconds of each track.

## Repeat A-B Mode

Set a segment of a music track to repeat in a continuous loop. During playback:

- ✦ To set the starting point “A” of the loop, press **A-B**.
- ✦ To set the end point “B” of the loop, press **A-B** again. The loop will now play from point “A” to point “B”.
- ✦ To resume normal playback, press **A-B** again.

# Video Mode

**Enter VIDEO mode to play AVI video files loaded on your player.**



Your player supports AVI files encoded with XviD at 320 x 240 and 20 fps. Videos must be encoded with the included software for device playback.

For more information about converting video, please refer to the section "Video Conversion".

## Video List

Use the Video List to view all compatible video files loaded on your player.





- ✦ Press **+** to move the selection down; press **-** to move the selection up.
- ✦ Press **▶/□** to enter a folder or to play a selection. Press **◀◀** to return to the previous screen.
- ✦ Press and hold **MENU** to cancel and return to the Main Menu.

## Video Playback Controls

Use the following controls during video playback.

Key	Function
Press <b>▶/□</b>	Play/Pause the playback.
Press <b>▶▶</b>	Play the next track.
Hold <b>▶▶</b>	Fast-forward through the current track.
Press <b>◀◀</b>	Play the previous track.

# Video Mode

Key	Function
Hold 	Reverse through the current track.
Press 	Decrease the volume level.
Press 	Increase the volume level.
Press 	Return to the Video List.
Hold 	Return to Main Menu.

# Photo Mode

***Enter PHOTO mode from the Main Menu to find and play JPEG image files loaded on your player.***

## **Photo List**

Use the Photo List view all picture files loaded on your player.

- ✦ Press **[-]** to move the selection up; press **[+]** to move the selection down.
- ✦ Press **[▶/|]** to confirm and display a selection.
- ✦ Press and hold **[MENU]** to cancel and return to the Main Menu.

## **Photo Controls**



The viewer can display photos with manual control or as a slideshow (photos are automatically displayed in sequence).

## **Displaying Pictures Manually**

- ✦ To display a picture, select it from the Photo List and press **[▶/|]** to confirm.
- ✦ Press **[▶▶]** to skip to the next picture; press **[◀◀]** to skip to the previous picture.
- ✦ Press **[MENU]** to return to the Photo List.

# Photo Mode

## Displaying Pictures as a Slideshow

- ✦ Select a photo from the Photo List and press  to confirm.
- ✦ Press  to start the slideshow. Press  again to stop the slideshow.
- ✦ Press **MENU** to cancel the slideshow and return to the Photo List.



*You can change the duration of time between the photos in the Settings menu. Please refer to the section “Settings Mode” for more information.*

# Radio Mode

**Enter Radio Mode to listen to FM radio broadcasts.**



*You must have a pair of headphones connected to the headphone jack to receive FM broadcasts; your player will utilize the headphone cord as an antenna.*

## **Basic FM Radio Operation**

Upon entering Radio mode, you can tune to stations manually (MANUAL) or to preset stations (PRESET).



*You can set the Radio mode to MANUAL or PRESET mode in the Radio Settings menu. Please refer to the section "Radio Settings Menu" below for more information.*

- ✦ **MANUAL:** Press or to tune to stations manually. To auto-seek to the next available broadcast station, press and hold or .
- ✦ **PRESET:** Press or to tune to the next Preset Station. You must save Preset Stations prior to using this tuning method.

## **Radio Settings Menu**

To enter the Radio Settings menu, press while the player is in Radio Mode.

- ✦ Press to move the selection down; press to move the selection up.
- ✦ Press to confirm the selection.
- ✦ Press to go back one level.



# Radio Mode

Item	Description
Manual	Select to set the player in MANUAL mode.
Preset	Select to set the player in PRESET mode.
Mem	Save a Preset Station.
Del	Delete a Preset Station.
Auto	Automatically scan and save all available station frequencies to Preset Station memory.

## Storing Preset Stations

Your player can store up to 30 station presets (01 to 30).

### Store Presets Manually

1. Tune to the station you want to store as a preset (e.g., 91.5).
2. Press **MENU** to access the Radio Settings menu. Select and confirm “Mem”.
3. Press **-** or **+** to select the desired Preset number and then press **▶/□** (e.g., CH01). A “Save Channel?” warning will appear on the screen.
4. Use **◀◀** or **▶▶** to select “YES” and then press **▶/□** to confirm. (Preset CH01 is now set to the station 91.5).

# Radio Mode

## Store Presets Automatically

Press **MENU** to access the Radio Settings menu. Select and confirm “Auto”. The player will automatically seek and store the first 30 frequencies with a broadcast signal.



*This will overwrite all previously stored preset stations.*

## Delete a Preset Station

1. Press **MENU** to access the Radio Settings menu. Select and confirm “Del”.
2. Press **-** or **+** to select the Preset number that you want to delete and then press **ENTER**. A “Delete Channel?” warning will appear on the screen.
3. Use **LEFT** or **RIGHT** to select “YES” and then press **ENTER** to delete the station.

# EBook Mode

***Enter EBOOK mode from the Main Menu to play text files (TXT) loaded on your player.***

## **EBook List**

Use the EBook List to view all text files loaded on your player.

- ✦ Press **[-]** to move the selection up; press **[+]** to move the selection down.
- ✦ Press **[▶/□]** to confirm and display a selection.
- ✦ Press and hold **[MENU]** to cancel and return to the Main Menu.

## **EBook Controls**

To display a text file, select and confirm the file from the EBook List. While the text file is displayed:





- ✦ Press **[▶▶]** or **[-]** to skip to the next page.
- ✦ Press **[◀◀]** or **[+]** to skip to the previous page.
- ✦ Press **[▶/□]** to display the pages with automatic scrolling (Auto Play); press **[▶/□]** again to stop the Auto Play.
- ✦ Press **[MENU]** to return to the EBook List.
- ✦ Press and hold **[MENU]** to return to the Main Menu.

# Explorer Mode

Enter EXPLORER mode to view all folders and files loaded on your player. If a compatible file is selected and confirmed, the file will be played in its corresponding mode.

- ✦ Music Mode: MP3, WMA
- ✦ Video Mode: AVI
- ✦ Photo Mode: JPEG
- ✦ EBook Mode: TXT

## Navigator Controls

- ✦ Press  to move the selection up; press  to move the selection down.
- ✦ Press  to confirm a selection.
  - ◇ If a folder has been selected, the contents of the folder will be displayed.
  - ◇ If a compatible file has been selected, the file will be played in its corresponding mode.
- ✦ Press  to cancel a screen and return to the previous folder.
- ✦ Press and hold  to return to the Main Menu.







# Settings Mode

***Enter SETUP mode from the Main Menu to change your player's internal option settings.***

- ✦ To select an option, press **+** or **-**. To confirm and enter, press **▶/□**.
- ✦ Press **◀◀** to cancel and return to the previous screen.
- ✦ To exit the Setup Menu, press and hold **MENU**.

The Setup Menu contains 7 options: Music, Radio, Display, Auto Play Set, System, PowerOff Time, and Default Set.

# Settings Mode

Item		Description
Music	Repeat Mode	Set a Repeat Mode option. Once: Play the current track once. Repeat One: Repeat the current track. Folder Once: Play all tracks in current folder once. Folder Repeat all tracks in current folder. All Once: Play all tracks once. All Repeat: Play all tracks repeatedly. Intro: Play the first 10 seconds of each track.
	Play Mode	Set a Play Mode option. Order: Play tracks in order. Shuffle: Play tracks in random order.
	EQ Select	Set a digital equalizer preset. The options are Normal, 3D, Rock, Pop, Classic, Bass, Jazz, and User EQ.
	User EQ Set	Set a custom equalizer setting. <ul style="list-style-type: none"> <li>• Press  or  to select a band to adjust.</li> <li>• Press  or  to adjust the selected band level.</li> <li>• Use  or  to select YES or NO.</li> </ul>
Radio	Stereo Switch	Set the reception mode. On: Stereo reception. Off: Mono reception.
	FM Region	Set the FM frequency range area: China, Europe, Japan, or U.S.A.

# Settings Mode

Item		Description
Display	BLight Time	Adjust the duration of time (in seconds) that the backlight will remain on after a key press. A setting of "Always On" will keep the backlight on continuously.
	Lum	Adjust the brightness (luminescence) of the display.
Auto Play Set	Text	Adjust the EBook mode "Auto Play" time interval.
	Jpeg	Adjust the Photo mode Slideshow time interval.
System	Language	Set the Language that the menus appear in.
	About	View the player's Firmware and capacity info.
	Upgrade	Select to upgrade the firmware (please refer to the section "Firmware Upgrades" for details).
	USB Mode	<p>Set the USB connection mode (MTP or MSC) when connecting the player to a computer.</p> <ul style="list-style-type: none"> <li>• MTP: This setting enables advanced synchronization features if you are using Windows Media Player 10 (WMP10) or newer. If an MTP connection is not available, the player will revert to MSC.</li> <li>• MSC. This setting enables the widest compatibility with all systems, and allows the player to be used as a removable storage device</li> </ul>

# Settings Mode

Item	Description
PowerOff Time	Set the duration of time (in minutes) that the player will remain on when it is idle. The setting of "OFF" will disable the Power Saving feature.
Default Set	Select to restore all of the player's setting to their factory-default state.



# USB Connections

Connect the player to a computer with the USB 2.0 cable provided to:

- ✦ Transfer files to and from your player.
- ✦ Perform basic file management functions.

## Connecting to a Computer

Connect the player to your computer with the supplied USB cable.

Upon connection:

- ✦ Your computer will automatically recognize the player as an MTP Device. An icon representing your player will appear under “Audio Devices” when you open “My Computer”.
- ✦ It may take Windows several minutes to recognize and set up the device the first time it is connected depending on your hardware configuration.

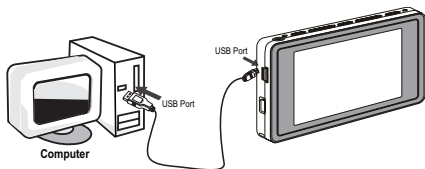

*For more information and support regarding music transfer and synchronization with Windows Media Player (WMP), please see the help section included with WMP (click “Help > Synchronizing Content to Devices”).*

# USB Connections

## Transferring Files

The USB 2.0 connection makes it easy to transfer music files (or any other data files) quickly between the player and your computer. Simply use the player as you would any removable storage device using basic operating system commands.

If you need further assistance with transferring files, please refer to your operating system's instruction manual or on-screen help. If you are using media management software such as iTunes, Winamp, or Windows Media Player, please refer to their documentation for support.



*Do not disconnect or otherwise interrupt the player during transmission—this could damage or corrupt the player's firmware or your files. If the player is accidentally disconnected and is not working properly, use the Power switch to turn your player off, and then back on again.*



*Content owners use Windows Media digital rights management technology (WMDRM) to protect their intellectual property, including copyrights. This device uses WMDRM software to access WMDRM-protected content. If the WMDRM software fails to protect the content, content owners may ask Microsoft to revoke the software's ability to use WMDRM to play or copy protected content. Revocation does not affect unprotected content. When you download licenses for protected content, you agree that Microsoft may include a revocation list with the licenses. Content owners may require you to upgrade WMDRM to access their content. If you decline an upgrade, you will not be able to access content that requires the upgrade.*

# USB Connections

## Microsoft Windows

1. Double-click the “My Computer” icon on your desktop and then double-click the Player icon (MTP Multimedia Player).
2. Your player contains two folders: Data and Media.
  - ✧ Drag your media files to the Media folder (e.g., MP3, WAV, WMA files).
  - ✧ Drag all other types of files to the Data folder for storage (e.g., TXT, DOC, XLS, etc). Data files are only visible from a computer; these files will not be available from within the player itself.

## Macintosh OS X

1. Open a finder window. Located the files you would like to transfer from your computer. Select the files/folders with the mouse and press APPLE-C (copy) on the keyboard.
2. Click on the Removable Disk icon located on the left side of the finder window. The computer will display all files and folders currently stored in the player.
3. Press APPLE-V (paste) on the keyboard to transfer the files you selected in Step 1 to the player.

# USB Connections

## Disconnecting from a Computer

Disconnect your player as instructed below to prevent data loss or file/firmware corruption.

### Microsoft Windows

1. Double-click the green arrow in the taskbar located on the lower-right side of the computer screen (Safely Remove Hardware).



2. **Safely Remove Hardware:** Select “USB Mass Storage Device” from the list that appears and then click on “Stop”.  
**Stop a Hardware Device:** Select “USB Mass Storage Device” from the list that appears and then click on “OK”.



Select “USB Mass Storage Device” from the list that appears and then click on “OK”.

3. When the “Safe to Remove Hardware” window appears, click the OK button and disconnect the USB cable from the player and your computer.

### Macintosh OS X

1. On the left side of the Finder Window, identify the appropriate Removable Disk icon.

# USB Connections

2. Click on the “Eject” arrow on the right of the Removable Disk icon.
3. Disconnect the USB cable from the player and your computer.



# Video Conversion

Use the video conversion software utility included on the Installation CD to create video files that are suitable for playback on the player.

Your player supports XviD-encoded AVI files with the following specifications:

- ✦ 320 x 240 resolution at 20 frames per second (fps).



*The video conversion software is included for your convenience and is compatible with Microsoft Windows operating systems only. There are many other video conversion utilities available for download or purchase on the internet.*

*Because the program is licensed free of charge, there is no warranty for the program, to the extent permitted by applicable law. Except when otherwise stated in writing the copyright holders and/or other parties provide the program "as is" without warranty of any kind, either expressed or implied, including, but not limited to, the implied warranties of merchantability and fitness for a particular purpose. The entire risk as to the quality and performance of the program is with you. Should the program prove defective, you assume the cost of all necessary servicing, repair or correction.*

*In no event unless required by applicable law or agreed to in writing will any copyright holder, or any other party who may modify and/or redistribute the program as permitted above, be liable to you for damages, including any general, special, incidental or consequential damages arising out of the use or inability to use the program (including but not limited to loss of data or data being rendered inaccurate or losses sustained by you or third parties or a failure of the program to operate with any other programs), even if such holder or other party has been advised of the possibility of such damages.*

# Video Conversion

## Installation

1. Locate the AVI Converter setup file on the Installation CD:

### **AVIConverter CHN-EN Package Setup.exe.**

2. Double-click the file to start the installation process.
3. Follow the on-screen instructions to complete the installation process.

## Converting Video

To start the program, double-click the AVIConverter shortcut on your desktop. The application window shown below will appear.

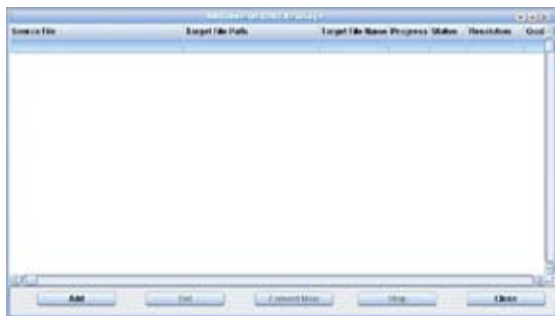

- ✦ Click the “Add” button. The Conversion Setting screen will appear. Use this screen to add video conversion jobs to the queue.

# Video Conversion



1. Set the Resolution to “320x240” as shown in the diagram above [1].
2. To select the Source File to convert, click the shaded box indicated in the diagram above [2]. The source file must be one of the following video types: AVI, RM, RMVB, MPG, MPEG, MP4, ASF, WMV, MKV, DAT, or VOB.
  - ✧ DirectX 9.0, Media Player 9.0, and other codecs must be installed to support all media types.
3. To select the Target File Path (destination folder) that the converted video will be saved to, click the shaded box indicated in the diagram [3].
4. Type the desired file name for the converted video in the box indicated in the diagram [4].
5. After all options have been selected, click the “Save” button [5] to save this conversion job to the queue.



# Video Conversion

- Once there are no more video conversion jobs to add to the queue, click the Close button [6] to return to the application window shown below.

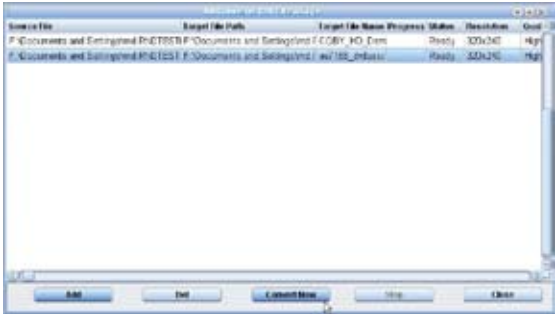

- The application window should now list all conversion jobs that you have added to the queue. Click the "Convert Now" button to start the conversion process.
- To exit the program, click the "Close" button.

# Windows Media Player

You can use Windows Media Player and a USB-MTP connection to manage your music media library with Microsoft Windows XP or newer.

The latest version of Windows Media Player can be downloaded from the Microsoft website:

<http://www.microsoft.com/windows/windowsmedia/default.mspx>

Please refer to the Quick Start Guide included with your player for more information.



*For more information and support regarding music transfer and synchronization with Windows Media Player (WMP), please see the help section included with WMP (click “Help > Synchronizing Content to Devices”).*

# Firmware Upgrades

From time to time, COBY may release firmware upgrades to improve the performance of the Player or to add additional features. Please check the COBY website periodically at [www.cobyusa.com](http://www.cobyusa.com) to see if new firmware has been released for your player. If you are experiencing abnormal behavior with your player, you may choose to restore (format) your player before updating its firmware.



*Do not interrupt the firmware upgrade process—doing so could damage your player and render it inoperable.*

*See the documentation that is included with the firmware upgrade file for detailed instructions.*

## About MP3/WMA Files

For more information about digital MP3 and WMA files, please visit our website at [www.cobyusa.com](http://www.cobyusa.com).

# Troubleshooting

If you have a problem with this device, please read the troubleshooting guide below and check our website at [www.cobyusa.com](http://www.cobyusa.com) for Frequently Asked Questions (FAQs) and firmware updates. If these resources do not resolve the problem, please contact Technical Support.

<b>Address</b>	COBY Electronics Technical Support 56-65 Rust Street Maspeth, NY 11378	
<b>Email</b>	techsupport@cobyusa.com	
<b>Web</b>	www.cobyusa.com	
<b>Phone</b>	800-727-3592:	Weekdays 8:00AM–11:00PM EST Weekends 9:00AM–5:30PM EST
	718-416-3197:	Weekdays 8:00AM–5:30PM EST

## ***The player does not turn on.***

- ✦ Ensure that the player is fully charged. Try charging the player overnight (8 hours).
- ✦ Ensure that the Power switch is set to the “On” position.
- ✦ Use the Power switch to turn the player off completely, and then turn it back on.

## ***The buttons do not work.***

- ✦ Ensure that the Hold switch is disengaged.
- ✦ Use the Power switch to turn the player off completely, and then turn it back on.

# Troubleshooting

## ***I cannot transfer files to the player.***

- ✦ Ensure that your computer is running a supported operating system.
- ✦ If using a USB extension cable, ensure that it is securely attached to the player and the PC, or try using another USB cable.
- ✦ If you have connected the player through a USB hub, try connecting the player directly to your computer.
- ✦ Ensure that the player's memory capacity is not full.
- ✦ Ensure that the Hold switch is disengaged.

## ***There is no sound during playback.***

- ✦ Check the volume level.
- ✦ Ensure that the headphones are attached securely to the player.

## ***The sound quality of the music is poor.***

- ✦ Try playing the file on your computer. If the sound quality is still poor, try downloading the file again or re-encoding the file yourself.
- ✦ Ensure that the bit rate of the file is not too low. The higher the bit rate of the file, the better it will sound. The minimum recommended bitrate is 128kbps for MP3s and 96kbps for WMAs.
- ✦ Try lowering the volume of the player.

# Troubleshooting

- ✦ Ensure that the headphones are attached securely to the player.

## ***The player will not play my music file.***

- ✦ Ensure that the file is in a compatible format.
- ✦ The file may be copy-protected and you no longer have authorization to play this file. If you feel this is in error, please contact the service from which you downloaded the file.

## ***The LCD characters are corrupted or something is wrong with the display.***

- ✦ Ensure that the correct menu language has been set.
- ✦ Use the Power switch to turn the player off completely, and then turn it back on.

## ***The player has malfunctioned.***

- ✦ Use the Power switch to turn the player off completely, and then turn it back on.
- ✦ Try updating the player's firmware. Please refer to the [Firmware Upgrades](#) section of this manual for instructions.

# Specifications

Display Type	2.4" Full-Color TFT @ 320 x 240
Memory	Integrated Flash Memory
Audio Format Support	MP3, WMA, WMA-DRM, WAV
Video Format Support	MPEG-4 (XviD): 320 x 240, 20fps
Photo Format Support	JPEG
DRM Support	WMDRM10*
Song Info Support	ID3, LRC
Recording Format	IMA-ADPCM Encoding
FM Frequency Range	87.5 - 108.0MHz
PC Interface	USB 2.0 (MSC or MTP)
Plug and Play Support	Windows 2000/XP or newer Mac OS X
Audio Output	3.5mm Stereo (Headphone)
Menu Language Support	English, Korean, Chinese, Spanish, French, German, Italian, Portuguese, Russian
Power Supply	Rechargeable Lithium-ion Battery USB Charge
Unit Dimensions	1.61" x 3.1" x 0.67" (WHD)

\* Music Service must support Windows Media DRM (WMDRM). WMDRM10 requires Windows XP and Windows Media Player 10 or newer.

Design, specifications, and manual are subject to change without prior notice.



# Notes

# Notes

# Notes

## **Coby Electronics Corporation**

56-65 Rust Street  
Maspeth, NY 11378

[www.cobyusa.com](http://www.cobyusa.com)

[www.ecoby.com](http://www.ecoby.com)

Coby is a registered trademark of Coby Electronics Corporation.

Printed in China.